

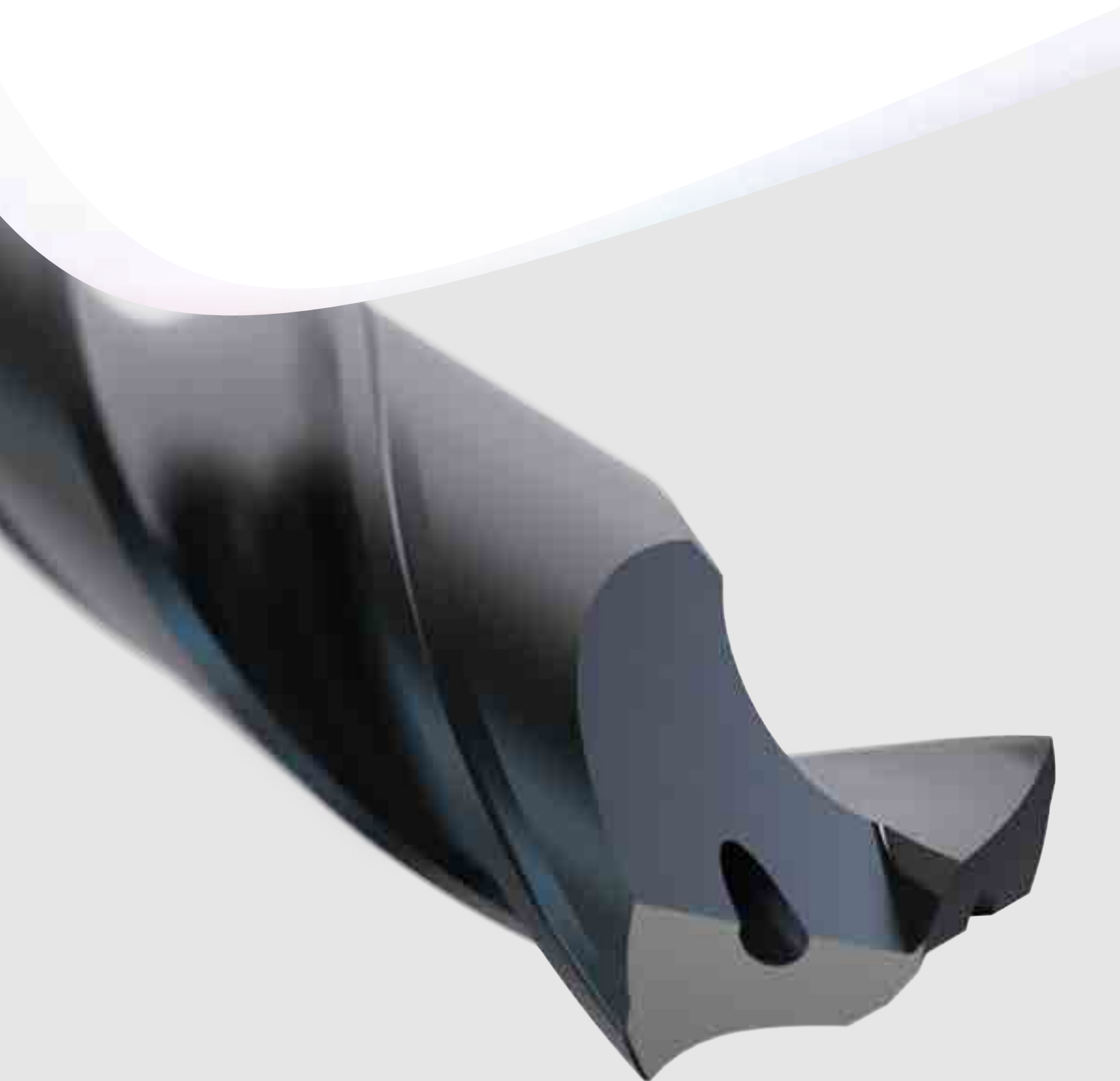

Catalogo e guida tecnica 2024.1

Lavorazione fori





In Seco, realizziamo utensili, tecnologie e soluzioni per le sfide di produzione più avanzate al mondo. Dalla nascita della casamadre a Fagersta, in Svezia, fino alla società internazionale che siamo oggi, il nostro business è sempre stato fondato sulla fiducia e sulle esigenze del cliente.

Combinando utensili di precisione all'avanguardia con collaborazioni durature, siamo un'azienda di persone che aiuta i nostri partner a vincere le sfide dell'industria manifatturiera.

Siamo orgogliosi di essere Made for maker. Aprire la strada al futuro e all'innovazione. In breve - se esiste l'utensile giusto per la lavorazione, lo forniremo ai nostri clienti. Se non esiste, lo creeremo.

Siamo orgogliosi di porre la sostenibilità al centro di tutto ciò che facciamo, sfidando le percezioni del nostro settore, cambiando il processo di produzione e giocando il nostro piccolo ruolo nel plasmare un futuro più luminoso.

Introduzione

Indice alfanumerico, utensili.....	4
Indice alfanumerico, inserti	6
Linee guida e panoramica.....	7

Foratura

Universal & Feedmax™

Gamma disponibile e informazioni tecniche.....	15
Punte Universal	24
Punte Feedmax	54
Linee guida e parametri di taglio	130

Crownloc®

Gamma disponibile e informazioni tecniche.....	171
Corpi punta e corone Crownloc.....	175
Linee guida e parametri di taglio	191

Crownloc® Plus

Gamma disponibile e informazioni tecniche.....	199
Corpi punta e corone Crownloc Plus.....	203
Linee guida e parametri di taglio	219

Perfomax®

Gamma disponibile e informazioni tecniche.....	225
Corpi punta e inserti Perfomax	232
Linee guida e parametri di taglio	292

Adattatori per punte

Panoramica	324
Adattatori.....	325

Alesatura

Precimaster™ Plus

Gamma disponibile e informazioni tecniche.....	326
Codoli e testine Precimaster Plus	343
Linee guida e parametri di taglio	358

Nanofix™

Gamma disponibile e informazioni tecniche.....	368
Alesatori Nanofix e portautensili	378
Linee guida e parametri di taglio	393

Nanojet

Gamma disponibile e informazioni tecniche.....	402
Alesatori Nanojet e portautensili	411
Linee guida e parametri di taglio	414

Bifix®

Gamma disponibile e informazioni tecniche.....	423
Steli, inserti e lame Bifix	429
Linee guida e parametri di taglio	438

Xfix™

Gamma disponibile informazioni tecniche.....	450
Testine, adattatori e inserti Xfix	456
Linee guida e parametri di taglio	480

Adattatori per alesatori

Panoramica	491
------------------	-----

Adattatori regolabili

Adattatori	494
------------------	-----

Mandrini flottanti

Attacchi.....	504
---------------	-----

Dispositivi di regolazione

Dispositivi di regolazione.....	510
---------------------------------	-----

Introduzione

Foratura

Alesatura

Barenatura

Allegato

Barenatura

Barenatura di sgrossatura

Gamma disponibile e informazioni tecniche.....	516
Graflex®	518
Seco-Capto™	548
Informazioni tecniche per barenatura di sgrossatura	585
Teste di barenatura e attacchi RB750	589
Teste di barenatura e attacchi RB610	602

Barenatura di finitura

Panoramica della gamma e informazioni tecniche	607
Teste di barenatura e attacchi FB760, FB780, FB790, FB620.....	614
Teste di Barenatura Radiali FB780,FB790, FB620	644

Ponti di barenatura

Gamma disponibile e informazioni tecniche.....	659
Attacchi e adattatori, barre, unità, cartucce	671

Soluzioni di barenatura personalizzate	677
--	-----

Inserti per barenatura	678
------------------------------	-----

Parametri di taglio	686
---------------------------	-----

Chiavi inserto e viti	690
-----------------------------	-----

Teste di barenatura, connessioni Graflex® o Seco-Capto™	691
---	-----

Allegato

Tolleranza standard ISO per fori e alberi	694
Tolleranza geometrica	697
Materiali dei pezzi in lavorazione - SMG	698
Dichiarazione di conformità.....	710

Introduzione	0	
	02E93	547
	03E93	547
	2	
20E93	547	
5		
5680094	547	
9		
990FBDD01	619	
A		
A610	602,605	
A724	654-655	
A725	654-655	
A726	654-655	
A729	656	
A7312	671	
A731S	672-674	
A750	589-590,592-596	
A760	614-615,623	
A761	621	
A762	622	
A763	622	
A765	622,624	
A780	648-649	
A782	654-655	
A789	657	
A790	651	
AFG0629	629	
B		
BA..-FB	653	
BA..-RB	604	
BAS25	627-628	
BDA16	626	
BM	325	
BM / 6100	325	
BM / 6101	325	
C		
C.-390.00	550-551	
C.-390.411	556	
C.-390.55	562-563	
C.-390.605	564	
C.-390B.140	460,466,472,478,558-559	
C.-390B.55	460,466,472,562-563	
C.-390B.58	460,466,472,478,562-563	
C.-391.01	460,466,472,478,571-572,575	
C.-391.02	460,466,573-574,577-578	
C.-391.0401	534-535	
C.-A390B.45	552-553	
C.-D..-BA	584	
C.-D..-GL	582-583	
C3-391	591,650	
C3-391.FB	617	
C4-391	591,650	
C5-391	591,650	
C5-391.07	620	
C5-391.FB	617	
C6-391	591,650	
C8-391	591,650	
E		
E2342 / 5191	568	
E2344 / 5191	568	
E3114 / 5191	566-567	
E3116 / 5191	566-567	
E3169 / 5191	560	
E3171 / 5191	560	
E3416 / 7312	671	
E3471 / 7312	671	

E4002 / 5191	566-567
E4002 / 5525	566-567
E9306 / 7312	671
E9374-D..-GL	579-580
E9376-D..-BA	581
E9376-D..-GL	579
E9474 / 5191	570
EM / 2502	530-531
EM / 2504	530-531
EM / 3214	528-529
EM / 3216	528-529
EM / 4002	528-529
EM0040	524
EM0050	524
EM2502	530-531
EM2504	530-531
EM2642	532-533
EM2644	532-533
EM3414	461,467,473,526-527
EM3416	461,467,473,479,526-527
EM3469	461,467,473,522-523
EM3471	461,467,473,479,522-523
EM4040	525
EM9303	520-521
EM9304	461,467,473,520-521
EM9306	461,467,473,479,520-521
G	
G3-FB760	616
G5-FB760	616
GL25	603,652
GL32	603,652
GL40	603,652
GL50	603,652
H	
HA..-C	460,466,472,478,554-555
HSKA / C	554-555
HSKA / G	520
HSKA63-FB	618
HSKTA..-GL	579-580
M	
M401	543-545
M402	461,467,473,479,536-537
M403	538-542,546
N	
N5BS	413
N5TS	411-412
NF06	381
NF10	381
NF4	383
NF6	382
NS06	384-385,389
NS10	385-389
NS4	391
NS6	390
P	
PCGNL16CA	675
PMX05	346
PMX06	346,350-353
PMX06B-16B	348
PMX08	346,351-353
PMX12	346,350-353
PMX16	346,350-353
PMX4	356
PMX5	343-344,354
PMX6	345,355
PMX8	357
PMX-AD	350-351
PMXB-FL	353
PMX-FL	352

S	
SAH	499
SCGCL	675
SD100	190
SD101	175
SD103	177-178
SD105	179
SD107	181
SD1103	25-30
SD1103A	31-36
SD1105A	37-53
SD200	87
SD203	114
SD203A	55-60,85-86,99-101,105,107-108
SD203A-MS	90-94
SD2040A	76
SD2050A	77
SD205A	61-68,102-104,106,112-113
SD205A-MS	95-98
SD206	69
SD2060A	78
SD206A	70
SD207A	71-73
SD216A	74
SD22	116-122
SD230A	75
SD245A	80-81
SD26	123-129
SD265A	83
SD400	215
SD403	203,205
SD405	207,209
SD408	211,213
SD522	232-234,236,238,240-241
SD523	243-252,254-257,259-260
SD524	262-263,265-267,269-271,273-276
SD525	277-279
SD542	280-281
SD572	282,284-285
SD602	290
SF	490,510-512
SR80	431
SR81	434
SR82	435
SSRCL	675
STGCR/L.CA	675
STRCR/L.CA	675
STSCR/L.CA	675
STTCR/L.CA	675

Introduzione	C	
	CCGT	682,684-685
	CCGW	684-685
	CCMT	682,684-685
	CCMW	684-685
	CNMG	683
	CPGT	682
	L	
	LNEG	454
	R	
RNAX	454	
Foratura	S	
	SCGX	296-298
	SCMT	682
	SD100	183
	SD100-K	183-189
	SD100-M	183-189
	SD100-P	183-189
	SD400-M	216-218
	SD400-P	216-218
	SPGX	296,300
Alesatura	T	
	TCGT	682,684-685
	TCGW	684-685
	TCMT	682,684-685
	TCMW	684-685
	W	
	WBGW	684-685
	WBGW	684-685
	WCMX	302-303
	Barenatura	
Allegato		

Superare qualsiasi sfida nella lavorazione fori

















La lavorazione fori può fare la differenza tra profitti e perdite e il successo richiede utensili di qualità per ottenere il massimo livello di produttività e di riduzione dei costi.

Per raggiungere questo livello di successo, i produttori hanno bisogno di un partner in grado di dimostrare la bontà dei processi e testare nuove soluzioni. Un partner capace di affrontare tutte le sfide specifiche con una gamma completa di utensili per foratura, alesatura e barenatura.

Seco Tools è il vostro fornitore unico di soluzioni complete per la lavorazione fori. Con anni di esperienza nello sviluppo di soluzioni per le applicazioni più impegnative dei clienti, disponiamo delle competenze di ricerca e sviluppo e taglio dei metalli necessarie per aiutare i produttori a raggiungere processi ottimali. Ci impegniamo a garantire la produttività dei nostri clienti. Ciò significa che è possibile acquistare utensili, ricevere assistenza tecnica, consultare esperti e sviluppare soluzioni con un solo fornitore, e accedere ad una gamma completa di punte, alesatori, e teste per barenatura, integrali e intercambiabili.



CHE COSA SI RICHIEDE QUANDO SI ESEGUE UN FORO?

	Foratura			Alesatura				Barenatura		Filettatura			
	Seco Universal Seco Feedmax™	Crownloc® Crownloc® Plus	Perfomax®	Precimaster™ Plus	Nanofix™ / Nanojet	Bifix®	Xfix™	Barenatura di sgrassatura	Barenatura di finitura	Threadmaster™	Maschi Threadmaster™	Filettatura di fresatura 396.18/19/20	
Pag.	24-170	171-224	225-323	328-367	368-401	423-449	450-490	518-606	607-658	Vedere il catalogo di (Filettatura)			
													
IT	7-9	9-10	12	6-8	6-8	6-7	6-7	9-10	5-6	-	-	-	-
	0,02 mm (0.0008")	0,05 mm (0.002")	-	Segue il preforo	Segue il preforo	Segue il preforo	Segue il preforo	0,005 mm (0.0002")	0,005 mm (0.0002")	-	Segue il preforo	Segue il preforo	-
	0,02 mm (0.0008")	0,05 mm (0.002")	-	0,007 mm (0.0003")	0,007 mm (0.0003")	0,005 mm (0.0002")	0,005 mm (0.0002")	0,02 mm (0.0008")	0,01 mm (0.0004")	-	-	-	-
	1,0 µm (39 µin)	1,6 µm (63 µin)	2,0 µm (79 µin)	0,6 µm (24 µin)	0,6 µm (24 µin)	0,25 µm (10 µin)	0,8 µm (31 µin)	1,0 µm (39 µin)	0,6 µm (24 µin)	-	-	-	-
TCTR	-	-	-	-	-	-	-	-	-	-	6H 6HX 6G 2B Normal	5HX 2BX Normal-X 6HX 6GX	-
Forma del filetto	-	-	-	-	-	-	-	-	-	M MF UNC UNF NPT NPTF BSP	M MF UNC UNF G NPT NPTF	M MF UNC UNF G	ISO UN W NPT NPTF BSPT

**Precisione di posizionamento**

Le testine per barenatura di sgrassatura Seco Feedmax A750 e la gamma completa di testine per barenatura di finitura sono gli utensili in grado di garantire la migliore precisione di posizionamento.

**Geometria del foro**

Per ottenere un'eccellente geometria del foro, ad esempio cilindricità e rettilineità, è possibile scegliere tra tutti gli utensili Seco per alesatura e barenatura; questi ultimi danno i migliori risultati per la rettilineità.

**Finitura superficiale**

Per ottenere una superficie del foro realmente liscia, la prima scelta è Bifix, mentre le testine Seco per barenatura di finitura offrono una gamma completa di possibilità di lavorazione.

TCTR

= Classe di tolleranza della filettatura

IT

= Tolleranza del foro

Attributi ISO

Attributo ISO	Spiegazione
ADJLN	Limite minimo regolazione
ADJLX	Limite massimo regolazione
ADJRG	Campo di regolazione
AN	Angolo di spoglia principale
APMX	Profondità di taglio massima
AZ	Massima profondità di penetrazione assiale
B	Larghezza stelo
BD	Diametro corpo
BD1	Diametro corpo 1
BD2	Diametro corpo 2
BDX	Diametro massimo corpo
BHTA	Semi-angolo conicità corpo
BLQ	Codice di qualità dell'equilibratura
BN	Larghezza fascetta di rinforzo
CBDP	Profondità centraggio
CDX	Profondità di taglio massima
CEDC	Conteggio taglienti
CHA	Angolo foro trasversale
CHW	Larghezza smusso frontale
CNT	Dimensione filettatura ingresso refrigerante
CW	Larghezza di taglio
CZC	Codice dimensione connessione
D1	Diametro foro di fissaggio
DC	Diametro
DCB	Diametro centraggio
DCBN	Diametro minimo centraggio
DCBX	Diametro massimo centraggio
DCB1	Diametro centraggio 1
DCC	Codice tipologia disegno
DCINN	Minimo diametro di taglio interno
DCINX	Massimo diametro di taglio interno
DCN	Diametro di taglio minimo
DCON	Diametro centraggio
DCX	Massimo diametro di taglio
DF	Diametro flangia
DMM	Diametro stelo
FLGW	Larghezza flangia
GAN	Angolo di taglio dell'inserto
GB	Angolo fascetta di rinforzo
HTB	Altezza corpo
IC	Diametro del cerchio inscritto
INSD	Diametro inserto
INSL	Lunghezza dell'inserto
KRINS	Angolo di attacco
L	Lunghezza del tagliente
LB	Lunghezza corpo
LB1	Lunghezza corpo 1
LCF	Lunghezza elica
LE	Lunghezza effettiva del tagliente
LF	Lunghezza funzionale
LFS	Lunghezza funzionale secondaria
LH	Lunghezza testina
LPR	Lunghezza sporgenza
LS	Lunghezza dello stelo
LSC	Lunghezza di bloccaggio
LU	Lunghezza utile
LUX	Lunghezza massima utilizzabile
M	Dimensione M
OAL	Lunghezza totale
RE	Raggio di punta
S	Spessore inserto
TDZ	Dimensione diametro filettatura
WB	Larghezza corpo
WF	Larghezza funzionale

Introduzione

Foratura

Alesatura

Barenatura

Allegato

Guida agli utensili

Feedmax, Crownloc e Performax vengono utilizzate per eseguire fori da 0,1 a 160 mm (0,004-6,299") di diametro, con tolleranze da IT8 a IT12. Per fori preformati, spesso viene utilizzata la barenatura per sgrossatura o per finitura parziale, con ponti di barenatura e ponti Jumbo per i diametri grandi. Infine, l'alta qualità dei fori viene ottenuta con testine per alesatura e per barenatura di finitura, raggiungendo tolleranze IT5 o IT6. * Sgrossatura IT 9/10, ** finitura IT 5/6

Filettatura di Fresatura:

Threadmaster DTM, TM, TM2, 396.18 e 396.19

La stessa fresa può essere impiegata per eseguire sia filettature destre che sinistre. Le versioni metriche e UN sono solo per filettature interne. È anche possibile eseguire tutti i tipi di tolleranza con lo stesso utensile.

Maschiatura:

Threadmaster Tap

Sono disponibili sia maschi a tagliare che a rullare per le filettature e le tolleranze più comuni.

Per maggiori informazioni fare riferimento al catalogo di Filettatura

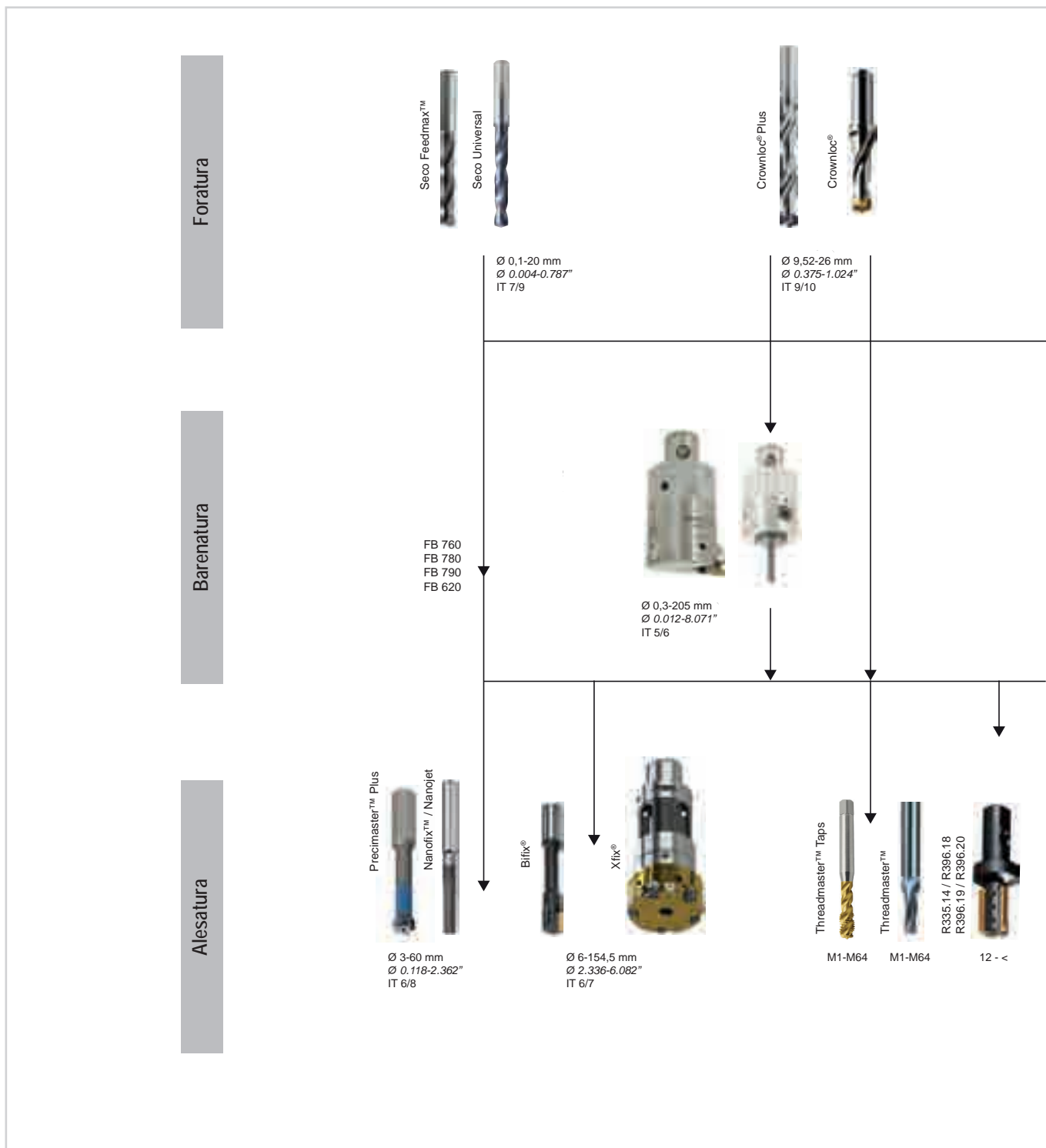

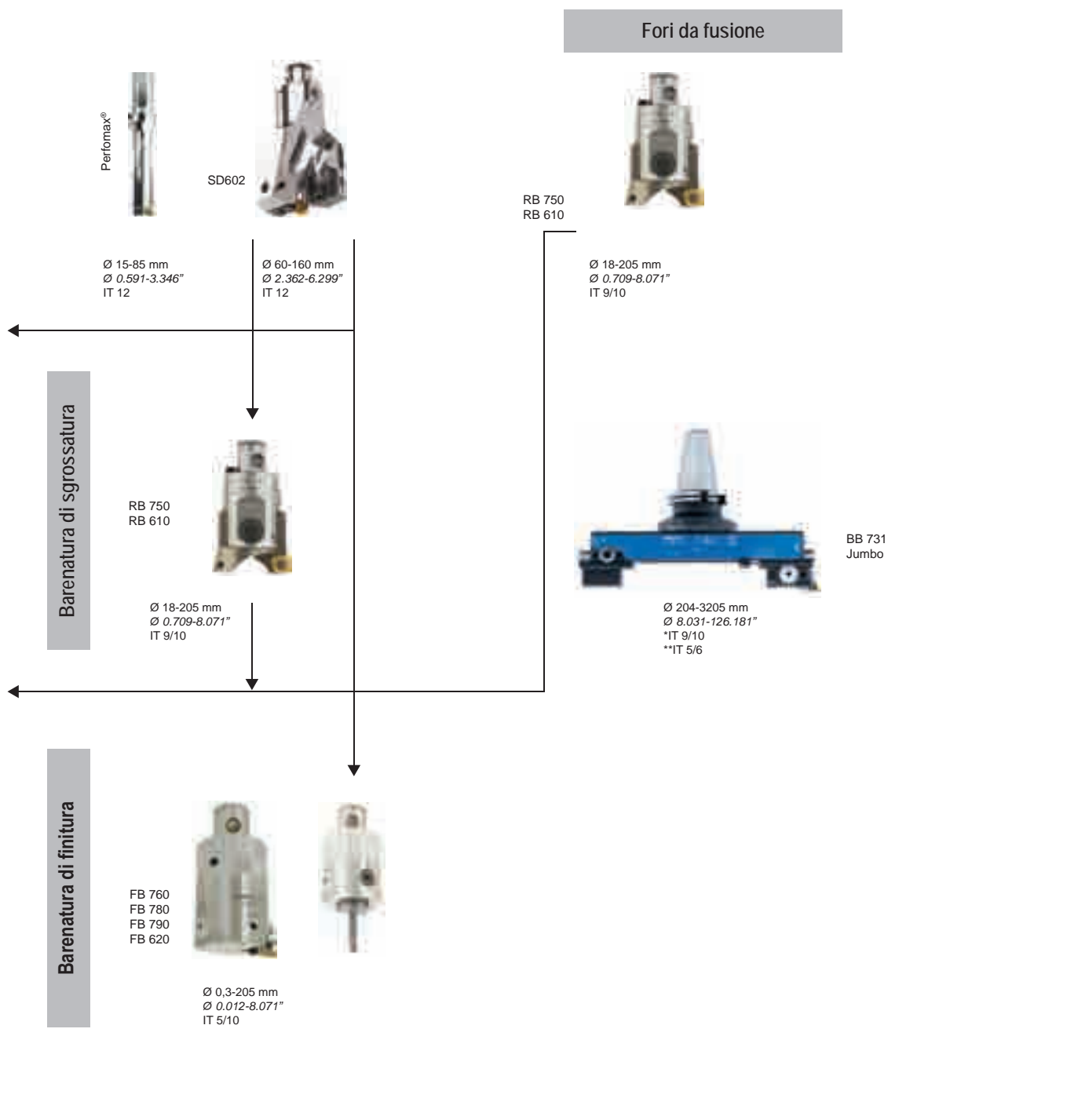

Foratura – Scelta della punta

Punte in metallo duro integrale Seco Feedmax™



PRODUTTIVITÀ

- Elevati avanzamenti e velocità di taglio
- Fori con tolleranza stretta
- Per applicazioni con elevata stabilità
- Per tutti i materiali

Punte con corona sostituibile Crownloc® e Crownloc®Plus



FLESSIBILITÀ

- Corone intercambiabili in metallo duro
- Geometrie per materiali differenti
- Nessuna riaffilatura
- Corone di svariati diametri per ogni corpo punta

Punte ad inserti sostituibili Perfomax®



ECONOMIA

- Qualità e geometrie per tutti i materiali
- Inserti quadri per un basso costo per foro
- Foratura, foratura con taglio interrotto, foratura attraverso fori preesistenti con ingresso o uscita inclinati, barenatura, ecc....
- Elevata sicurezza applicativa

Gruppo materiale Seco - Introduzione

L'idea base della versione dei gruppi materiale Seco è di classificare i materiali in base alla loro tipologia piuttosto che in base alla loro lavorabilità relativa. Di conseguenza, la classificazione contiene anche altri tipi di materiali, come i materiali compositi. È abbastanza completa, ma è comunque facile identificare a quale gruppo materiale Seco appartiene un particolare materiale.

Ogni gruppo materiale Seco ha uno standard specifico per il materiale in una condizione specifica assegnata, come riferimento per consentire una facile regolazione dei parametri di taglio per qualsiasi materiale reale rispetto a qualsiasi materiale di riferimento Seco (vedere le pagine 698-709).

Consideriamo come esempi il materiale EN C45E per il gruppo P4 e il materiale EN 42CrMo4 per entrambi i gruppi P5 e H5 (vedere ulteriori dettagli sulle tabelle seguenti). Nel gruppo materiale Seco, la classificazione dei materiali da lavorare ha uno standard specifico per il materiale in una condizione specifica assegnata, come riferimento per un regolazione facile e univoca dei parametri di taglio per qualsiasi materiale reale rispetto a qualsiasi materiale di riferimento Seco. Come esempi, i materiali di riferimento EN C45E per il gruppo materiale Seco P4 ed EN 42 CrMo 4 per il gruppo materiale Seco P5 e il gruppo materiale Seco H5 sono indicati nella tabella 1, dove è indicata la proprietà del materiale del livello di riferimento.

Gruppo materiale Seco	Descrizione	Proprietà	Riferimento	Gruppo materiale Seco	Descrizione	Proprietà	Riferimento
P4	Acciai da costruzione basso legati, 0,25% < C < 0,67%w Acciai da bonifica basso legati	$520 < R_m < 1200$	C 45E $R_m = 660 \text{ N/mm}^2$	H5	Acciai bonificati	$38 < \text{HRC} < 56$	42 CrMo 4 50 HRC
P5	Acciai da costruzione, 0,25% < C < 0,67%wt Acciai da bonifica	$550 < R_m < 1200$	42 CrMo 4 $R_m = 700 \text{ N/mm}^2$				

Concentrandosi specificamente sul EN 42 CrMo 4 in condizioni di ricottura, la resistenza alla tensione finale R_m può variare in genere tra $R_m = 630 \text{ N/mm}^2$ e $R_m = 780 \text{ N/mm}^2$, che forniscono un livello di riferimento per il gruppo materiale Seco P5.

In condizione di bonifica, la resistenza alla tensione finale R_m può essere generalmente compresa tra $R_m = 900 \text{ N/mm}^2$ e $R_m = 1100 \text{ N/mm}^2$, quindi appartiene ancora al gruppo materiale Seco P5. Tuttavia, se temprato al di sopra di $R_m = 1200 \text{ N/mm}^2$, ora appartiene al gruppo materiale Seco H5.

Gruppo materiale Seco	EN	W.-Nr	AFNOR	BS	UNI	JIS	AISI / ASTM	GOST	Condizioni	R_{m_nom}	HRC_{nom}
P4	42 CrMo 4	1.1201	42 CD 4	708 M 40	42 CrMo 4	SCM 440 (H)	4142, 4140	38HM	Ricottura	700	
	42 CrMo 4	1.1201	42 CD 4	708 M 40	42 CrMo 4	SCM 440 (H)	4142, 4140	38HM	Da bonifica	1000	
H5	42 CrMo 4	1.1201	42 CD 4	708 M 40	42 CrMo 4	SCM 440 (H)	4142, 4140	38HM	Da bonifica		45
	42 CrMo 4	1.1201	42 CD 4	708 M 40	42 CrMo 4	SCM 440 (H)	4142, 4140	38HM	Da bonifica		50

L'acciaio da bonifica EN 42CrMo4 può essere utilizzato per illustrare la dipendenza di lavorabilità della condizione dei materiali.

I grafici riportati di seguito indicano in che modo le raccomandazioni di velocità per le condizioni nominali di un materiale possono essere regolate per R_m relativo (diagramma a sinistra valido per ISO-P) e per HRC relativo (valido per ISO-H).

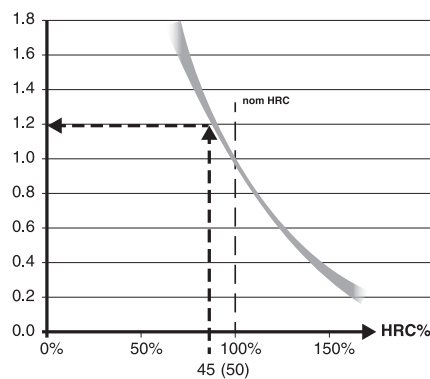
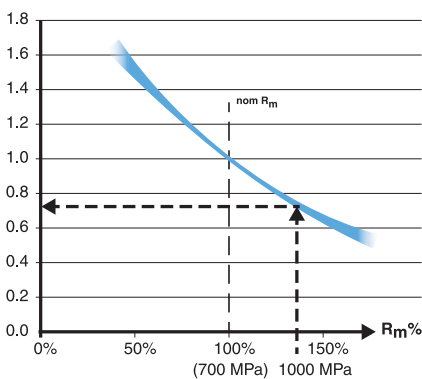

Per illustrare ulteriormente in che modo è possibile regolare il valore v_c nominale per il gruppo materiale Seco P5 ad un valore v_c più accurato, sono necessari i dati R_m della resistenza alla tensione finale e in questo caso si utilizza EN 42 CrMo 4 da bonifica a $R_m = 1000 \text{ N/mm}^2$ in base alla tabella precedente (freccia in grassetto blu). Supponiamo che il gruppo materiale Seco P5 nominale $v_c = 280 \text{ m/min}$ per un prodotto e una lavorazione determinati.

Quindi, il valore v_c effettivo consigliato = $280 \text{ m/min} \times 0,75 = 210 \text{ m/min}$. Di conseguenza, nel gruppo materiale Seco H5, il v_c nominale può essere regolato utilizzando EN 42 CrMo 4 temprato in HRC 45 (freccie grigie più piccole).

Supponiamo che il gruppo materiale Seco H5 nominale $v_c = 50 \text{ m/min}$ per un determinato prodotto e che la lavorazione avvenga con un utensile in metallo duro rivestito, quindi il valore v_c effettivo consigliato = $50 \text{ m/min} \times 1,2 = 60 \text{ m/min}$.

Per ulteriori dettagli sul materiale da lavorare, vedere le pagine 698-709 e i parametri di taglio suggeriti alle pagine applicabili.

Per una gestione più pratica dei parametri di taglio, consigliamo gli utensili applicabili in My Pages – Suggest su www.secotools.com

Soluzioni ad alte prestazioni e Universal

Cosa richiedete quando eseguite una foratura con una punta integrale?

Universal – Punta in metallo duro integrale con versatilità e produttività

Universal è una punta in metallo duro integrale versatile, che può essere impiegata in una vasta gamma di materiali e applicazioni in tutti i settori industriali. Grazie alla robusta geometria autocentrante a 140° e alla eccellente qualità della finitura, vengono garantite ad un costo molto basso elevata produttività, sicurezza e flessibilità applicativa.

Con Universal è possibile utilizzare lo stesso utensile in diverse applicazioni e di conseguenza ridurre i tempi di set up. Universal è un'alternativa a Seco Feedmax™ quando gli obiettivi principali sono versatilità, flessibilità e riduzione dei costi relativi alla gestione utensili.

Feedmax™ – Punta in metallo duro integrale ad alta produttività

Feedmax™ offre una combinazione unica di metallo duro, rivestimento e geometria all'avanguardia.

Feedmax™ è progettata per alta produttività e basso costo per foro, con avanzamenti elevati, fino a 0,70 mm/giro (0,028 pollici/giro), ed alte velocità di taglio, fino a 220 m/min (720 sf/min). Grazie alle capacità autocentranti, si ottengono fori di alta qualità anche senza eseguire operazioni di centratura. Grazie al rivestimento di ultima generazione con elevata durezza a caldo, ai taglianti robusti con smussi di protezione, al cilindretto in metallo duro ad elevata resistenza, alle eccellenti capacità di evacuazione truciolo ed all'eccellente qualità della geometria di taglio, si ottiene una durata lunga e prevedibile.

Feedmax™ ha una vasta gamma di geometrie ottimizzate per materiali ed applicazioni diverse, per ottenere un foro di buona qualità al costo più basso.

Volume di truciolo asportato (cm³/min)

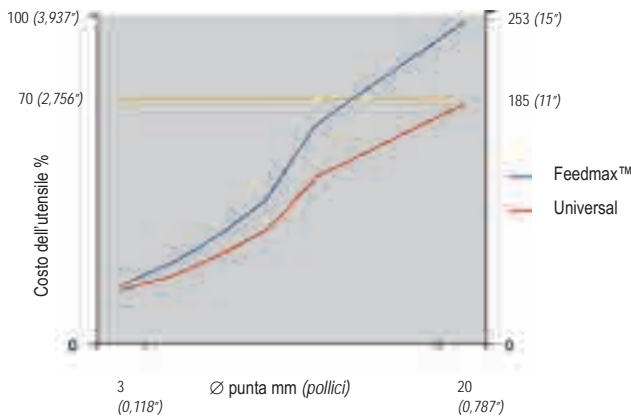

Feedmax™ Geometrie ottimizzate per l'applicazione / Feedmax™ Geometrie ottimizzate per il materiale

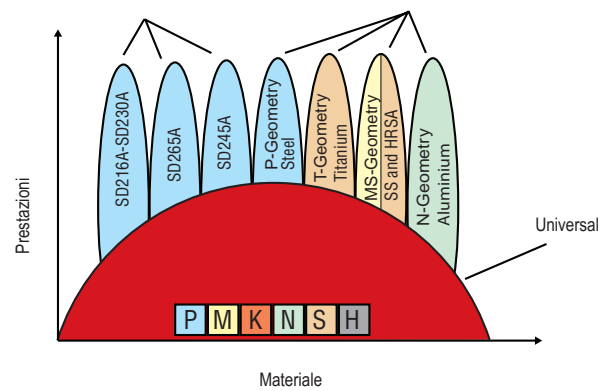

Durata con parametri di taglio bassi

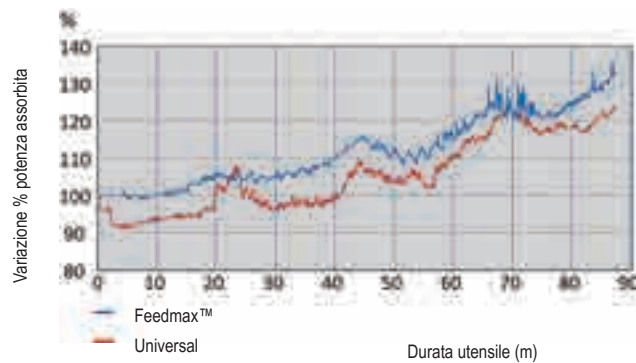

Durata con parametri di taglio alti

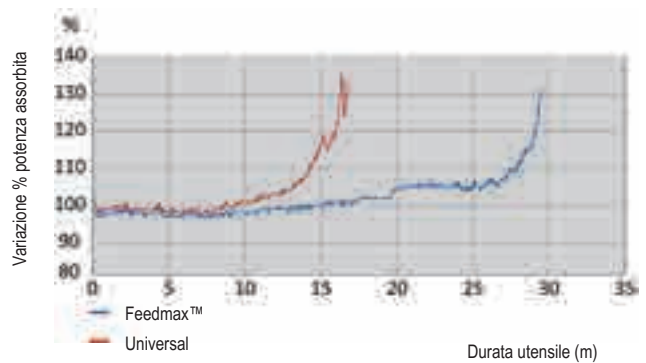

Percentuale di sforzo al mandrino; valore di riferimento 100% rilevato al primo foro
 Parametri di taglio
 $v_c = 90$ m/min
 $f = 0,15$ mm/giro

$v_c = 295$ sf/min
 $f = 0,006$ pollici/giro

Materiale = gruppo materiale P5-P6, SS2244, DIN41CrMo4, AISI 4140

Percentuale di sforzo al mandrino; valore di riferimento 100% rilevato al primo foro
 Parametri di taglio
 $v_c = 160$ m/min
 $f = 0,24$ mm/giro

$v_c = 525$ sf/min
 $f = 0,009$ pollici/giro

Materiale = gruppo materiale P5-P6, SS2244, DIN41CrMo4, AISI 4140

Introduzione

Foratura

Alesatura

Barenatura

Allegato

Panoramica della gamma

Universal & Feedmax™	Pagine	Gamma ∅	Profondità di foratura	Tolleranza ∅ punta	Tolleranza foro (1)	Finitura superficiale (2)
SD1103 	25, 26, 27, 28, 29, 30	3-20 mm (0.118-0.787")	~ 3 x D	m7	IT 8-9	Ra 1-2 μm (Ra 39-79 μin)
SD1103A 	31, 32, 33, 34, 35, 36	3-20 mm (0.118-0.787")	~ 3 x D	m7	IT 8-9	Ra 1-2 μm (Ra 39-79 μin)
SD1105A 	37, 38, 39, 40, 41, 42, 43, 44	3-20 mm (0.118-0.787")	~ 5 x D	m7	IT 8-9	Ra 1-3 μm (Ra 39-118 μin)
SD1108A 	45, 46, 47, 48, 49	3-20 mm (0.118-0.787")	~ 8 x D	m7	IT 9	Ra 1-3 μm (Ra 39-118 μin)
SD1112A 	50, 51, 52, 53	3-20 mm (0.118-0.787")	~ 12 x D	m7	IT 9	Ra 1-3 μm (Ra 39-118 μin)
SD203A-P 	55, 56, 57, 58, 59, 60	2-20 mm (0.078-0.787")	~ 3 x D	m7	IT 8-9	Ra 1-2 μm (Ra 39-79 μin)
SD205A-P 	61, 62, 63, 64, 65, 66, 67, 68	2-20 mm (0.078-0.787")	~ 5 x D	m7	IT 8-9	Ra 1-2 μm (Ra 39-79 μin)
SD206, SD206A 	69, 70	0,7-2,0 mm (0.027-0.078")	~ 6 x D	h6	IT 9	Ra 1-2 μm (Ra 39-79 μin)
SD207A-P 	71, 72, 73	3-20 mm (0.118-0.787")	~ 7 x D	m7	IT 9	Ra 1-3 μm (Ra 39-118 μin)

1) Possono verificarsi variazioni a seconda del materiale da lavorare e dei parametri di taglio utilizzati.

2) La profondità di foratura, i parametri di taglio, la pressione del refrigerante e il materiale da lavorare possono causare il deterioramento della finitura superficiale.

Panoramica della gamma

Feedmax™	Pagine	Gamma Ø	Profondità di foratura	Tolleranza Ø punta	Tolleranza foro (1)	Finitura superficiale (2)
 SD216A	74	3-12 mm (0.118-0.472")	~ 16 x D	m7	IT 9	Ra 1-3 µm (Ra 39-118 µin)
 SD230A	75	4-10 mm (0.157-0.393")	~ 30 x D	m7	IT 9	Ra 1-3 µm (Ra 39-118 µin)
 SD2040A	76	3-8 mm (0.118-0.315")	~ 40 x D	e8	IT 9-10	Ra 1-3 µm (Ra 39-118 µin)
 SD2050A	77	3-6,35 mm (0.118-0.250")	~ 50 x D	e8	IT 9	Ra 1-3 µm (Ra 39-118 µin)
 SD2060A	78	3-5 mm (0.118-0.197")	~ 60 x D	e8	IT 9	Ra 1-3 µm (Ra 39-118 µin)
 SD245A	79-80, 81	5-14 mm (0.196-0.551")	~ 5 x D	m7	IT 8	Ra 1-2 µm (Ra 39-79 µin)
 SD265A	83	6-16 mm (0.236-0.630")	~ 5 x D	js6	IT 7	Ra 1-2 µm (Ra 39-79 µin)
 SD203A-MS Superleghe	90, 91, 92, 93, 94	2-20 mm (0.079-0.551")	~ 3 x D	m7	IT 8-9	Ra 1-2 µm (Ra 39-79 µin)
 SD205A-MS Superleghe	95, 96, 97, 98	2-20 mm (0.079-0.551")	~ 5 x D	m7	IT 8-9	Ra 1-2 µm (Ra 39-79 µin)

1) Possono verificarsi variazioni a seconda del materiale da lavorare e dei parametri di taglio utilizzati.

2) La profondità di foratura, i parametri di taglio, la pressione del refrigerante e il materiale da lavorare possono causare il deterioramento della finitura superficiale.

Panoramica della gamma

Feedmax™	Pagine	Gamma ∅	Profondità di foratura	Tolleranza ∅ punta	Tolleranza foro (1)	Finitura superficiale (2)
SD203A-M 	99, 100, 101	3-14,25 mm (.118-.561")	~ 3 x D	m7	IT 8-9	Ra 1-2 μm (Ra 39-79 μin)
SD205A-M 	102, 103, 104	2,5-16 mm (.098-.630")	~ 5 x D	m7	IT 8-9	Ra 1-2 μm (Ra 39-79 μin)
SD203A-T, SD205A-T 	105, 106	4,73-12 mm (.188-.472")	~ 3 x D, ~ 5 x D	m7	IT 8-9	Ra 1-2 μm (Ra 39-79 μin)
SD203A-N 	107, 108	2,5-14 mm (.098-.551")	~ 3 x D	m7	IT 8-9	Ra 1-2 μm (Ra 39-79 μin)
SD205A-C1, -C2 	112-113	6-9,55 mm (.236-.376")	~ 5 x D	m7	IT 9	-
SD203-CX1 	114	3,26-9,53 mm (0.128-0.375")	~ 5 x D	m7	IT 9	-
SD22 	116, 117, 118, 119, 120, 121, 122	0,1-2,0 mm (0.004-0.079")	~ 2 x D	0,005/0 mm (+0.0002"/0)	-	-
SD26 	123, 124, 125, 126, 127, 128, 129	0,1-2,0 mm (0.004-0.079")	~ 6 x D	0/-0,004 mm (0/-0.00016")	-	-

1) Possono verificarsi variazioni a seconda del materiale da lavorare e dei parametri di taglio utilizzati.

2) La profondità di foratura, i parametri di taglio, la pressione del refrigerante e il materiale da lavorare possono causare il deterioramento della finitura superficiale.

Chiavi di codifica

Universal

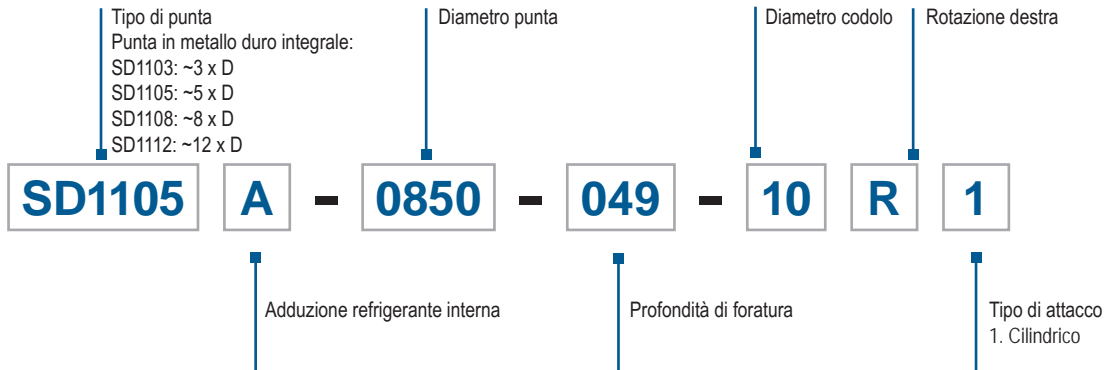

Feedmax™

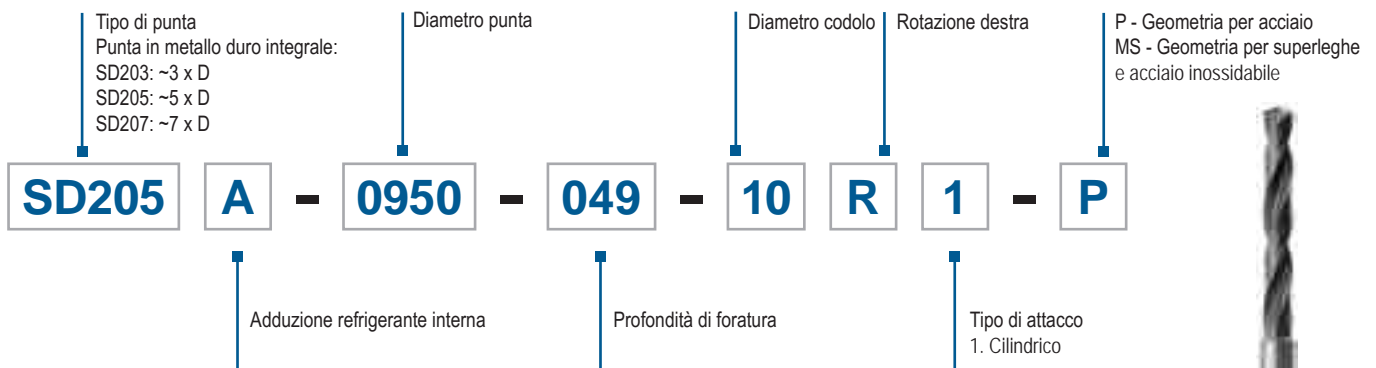

Feedmax™

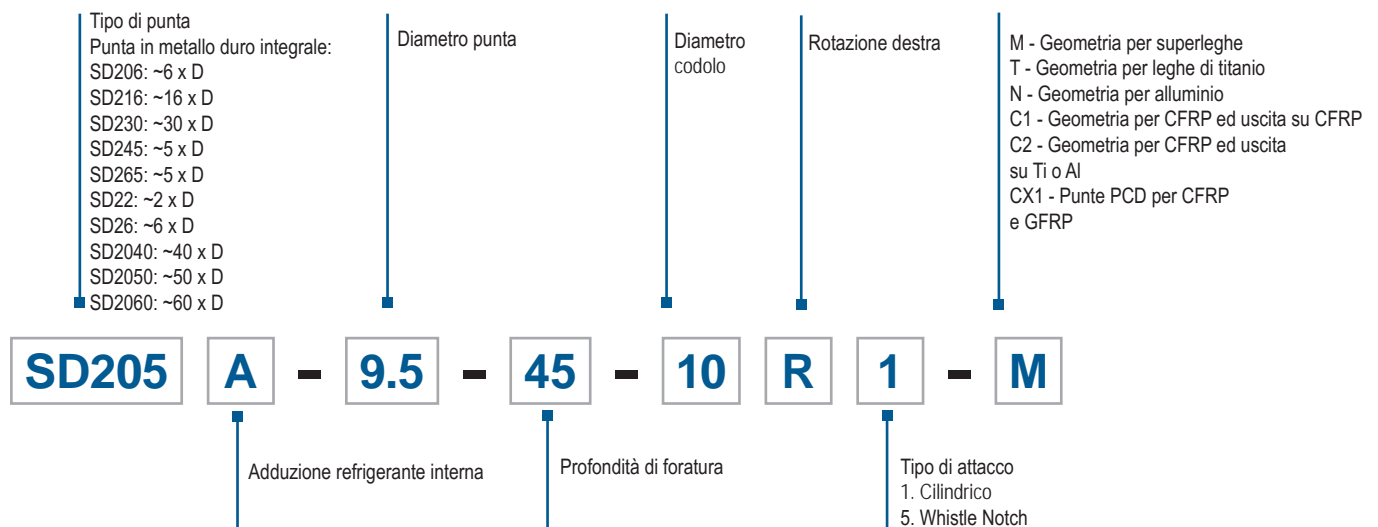

Montaggio

Attacchi/eccentricità

Le punte con attacco cilindrico possono essere utilizzate con attacchi a calettamento termico, attacchi a bloccaggio idraulico o con pinze di precisione. Mantenere l'eccentricità complessiva entro 0,04 mm (0,0016") misurata in macchina. Il massimo rendimento della punta si ottiene contenendo l'eccentricità entro 0,02 mm (0,0008").

Stabilità

La stabilità dell'applicazione è importante per la migliore durata utensile e precisione dei fori.

Controllare le condizioni del mandrino macchina, il fissaggio e lo staffaggio dei componenti per assicurare la massima rigidità e stabilità. Condizioni di lavoro poco stabili possono causare la rottura dell'utensile.

Attacchi consigliati

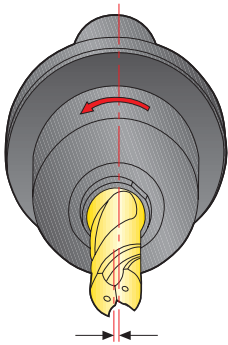

Per il massimo rendimento della punta utilizzare gli attacchi:
 Tipo 5603 - Attacchi a calettamento termico, tipo DIN
 Tipo 5834/HC/HCR/HCS
 Tipo 5672 - Pinze ad alta precisione
 Per ulteriori informazioni, vedere il catalogo Sistemi di Utensili

Max. 0,02 mm (0.0008")

Durata utensile

Non utilizzare punte con usura superiore a 0,1-0,3 mm (0,004-0,012") misurata nel punto massimo.

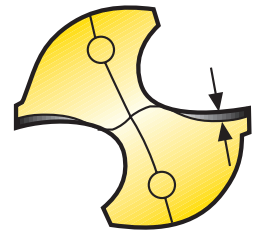

0,1-0,3 mm (0,004-0,012")

Attacco a calettamento termico: (solo per attacchi cilindrici -R1)



Mandrino idraulico (solo per attacchi cilindrici -R1)



Porta pinze ad alta precisione (solo per attacchi cilindrici -R1)



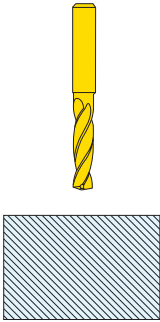
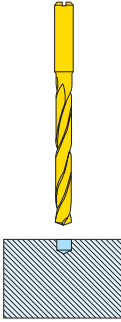
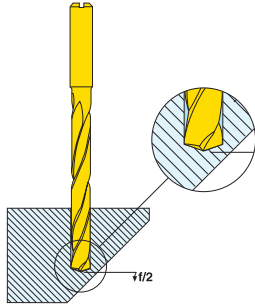
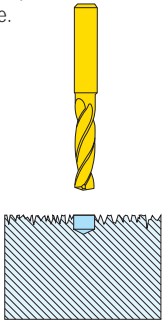
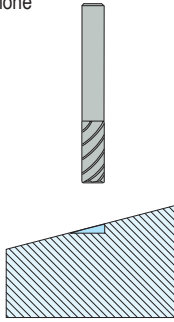
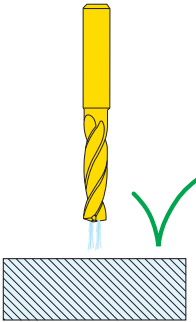
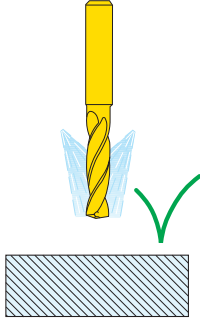

Metodi di lavorazione

Foro con entrata su una superficie lavorata		Foro con uscita inclinata	
<p>3-15 x D</p>  <p>Nessuna pre-foratura e nessun avanzamento d'ingresso necessari.</p>	<p>> 16 x D</p>  <p>Usando una punta più lunga è consigliato effettuare un foro pilota.</p>	<p>Prima dell'uscita, ridurre l'avanzamento al giro del 50%</p>  <p>Oppure usare punte SD245A.</p>	
Foro con entrata irregolare/inclinata			
<p>Se il foro ha entrata irregolare o inclinata, effettuare le pre-lavorazioni necessarie.</p>  <p>Foro con entrata regolare</p> <p>Effettuare un pre-foro con una punta Feedmax standard.</p>	<p>Alternative di pre-lavorazione</p>  <p>Foro con entrata inclinata</p> <p>Creare un piano utilizzando una fresa integrale della gamma Seco.</p>		
Raccomandazioni sul refrigerante			
<p>1.</p>  <p>Prima scelta</p>	<p>2.</p>  <p>≤ 5 x D</p>	<p>1. Pressione refrigerante*</p> <p>Pressione minima del refrigerante raccomandata 10 bar se ≤ 5 x D</p> <p>Pressione minima del refrigerante raccomandata 30 bar se > 5 x D</p> <p>Pressione minima del refrigerante raccomandata 40 bar se > 16 x D</p> <p>2. Composizione del refrigerante</p> <p>Percentuale di olio nell'emulsione raccomandata 6-8%. Quando si forano acciai inossidabile, superleghe ed acciai ad alta resistenza, si consiglia di utilizzare una concentrazione del 10%.</p>	

*Se viene utilizzata una pressione refrigerante inferiore, regolare i parametri di taglio di conseguenza.

Ciclo di Foratura profonda - Strategia di lavorazione - Produttività

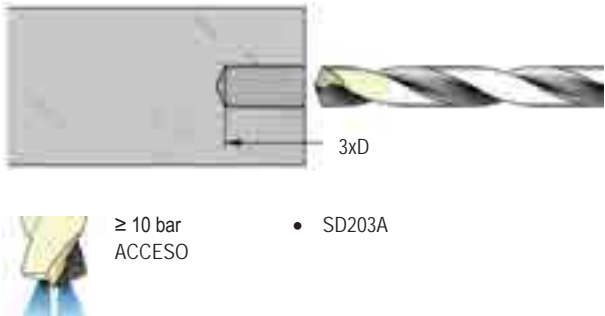
Da SD216A (16 x D) a SD2040A (40 x D)

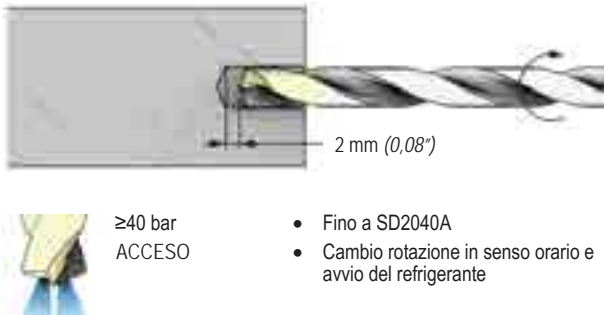
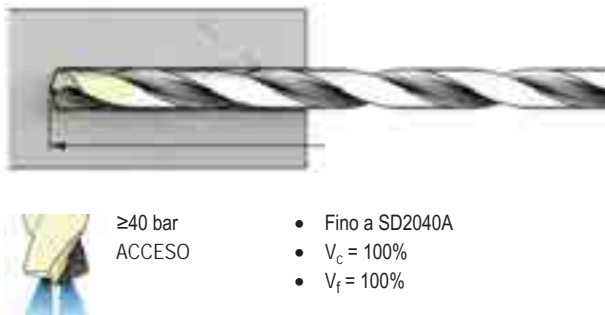
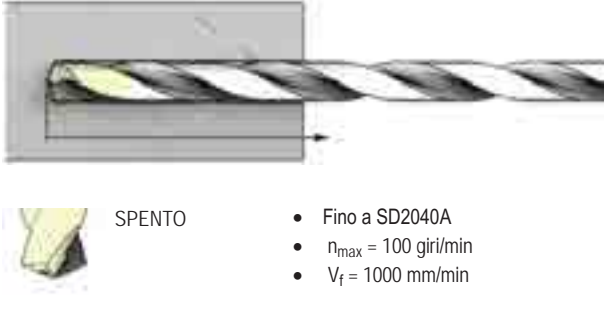
<p>1. Punta pilota</p>  <p>3xD</p> <p>≥ 10 bar ACCESO</p> <ul style="list-style-type: none"> • SD203A 	<p>2. Avviamento</p>  <p>2 mm (0,08°)</p> <p>SPENTO</p> <ul style="list-style-type: none"> • Fino a SD2040A • Con rotazione in senso antiorario e arresto 2 mm dal fondo del foro • $n_{max} = 100$ giri/min • $V_f = 1000$ mm/min 	Introduzione
<p>3. Cambio rotazione del mandrino</p>  <p>2 mm (0,08°)</p> <p>≥ 40 bar ACCESO</p> <ul style="list-style-type: none"> • Fino a SD2040A • Cambio rotazione in senso orario e avvio del refrigerante 	<p>4. Foratura profonda</p>  <p>≥ 40 bar ACCESO</p> <ul style="list-style-type: none"> • Fino a SD2040A • $V_c = 100\%$ • $V_f = 100\%$ 	Foratura
<p>5. Uscita</p>  <p>SPENTO</p> <ul style="list-style-type: none"> • Fino a SD2040A • $n_{max} = 100$ giri/min • $V_f = 1000$ mm/min 		Alesatura
		Barenatura
		Allegato

Ciclo di Foratura profonda - Strategia di lavorazione - Produttività

Da SD230A (30xD) a SD2060A (60xD)

1. Punta pilota

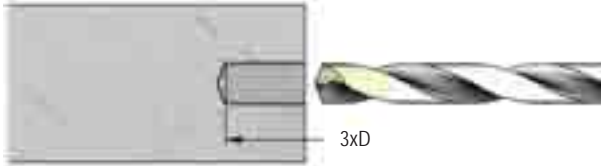

≥ 10 bar
ACCESO

- SD203A

2. Avviamento

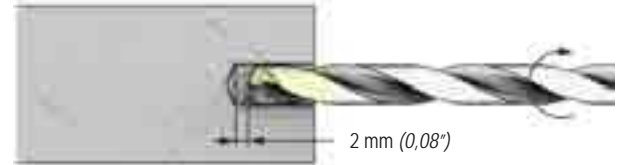

OFF

- Fino a SD216A
- Con rotazione in senso antiorario e arresto 2 mm dal fondo del foro
- $n_{max} = 100$ giri/min
- $V_f = 1000$ mm/min

3. Pre-foratura

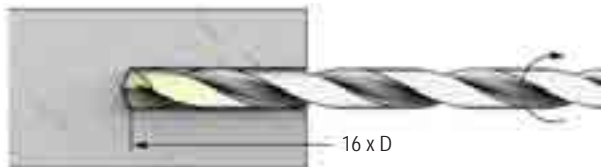

≥ 10 bar
ACCESO

- Fino a SD216A
- $V_c = 100\%$
- $V_f = 100\%$

4. Avviamento

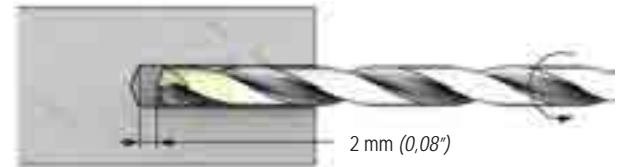

OFF

- Fino a SD2060A
- Con rotazione in senso antiorario e arresto 2 mm dal fondo del foro
- $n_{max} = 100$ giri/min
- $V_f = 1000$ mm/min

5. Cambio rotazione del mandrino

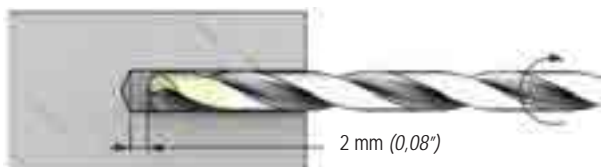

≥ 40 bar
ACCESO

- SD230A - SD2060A
- Cambio rotazione in senso orario e avvio del refrigerante

6. Foratura profonda



≥ 40 bar
ACCESO

- SD230A - SD2060A
- $V_c = 100\%$
- $V_f = 100\%$

7. Uscita



OFF

- SD230A - SD2060A
- $n_{max} = 100$ giri/min
- $V_f = 1000$ mm/min

Istruzioni di montaggio del modulo per smussi

<p>1.</p>	<p>2.</p>	<p>3.</p>
<p>4.</p>	<p>Massima profondità di smussatura</p>	

Diametro punta DC		LU profondità di foratura (min-max)					
		SD1103 / SD203A		SD1105 / SD205A		SD207A	
mm	inch	mm	inch	mm	inch	mm	inch
4,00-4,75	.157-.187	4-17	.157-.669	10-27	.394-1.063	30-45	1.181-1.772
4,76-6,00	.187-.236	6-20	.236-.787	18-32	.709-1.260	30-45	1.181-1.772
6,01-8,00	.241-.315	15-27	.590-1.063	28-42	1.102-1.653	42-57	1.653-2.244
8,01-10,00	.315-.394	17-31	.669-1.220	34-48	1.338-1.890	47-62	1.850-2.441
10,01-12,00	.394-.472	21-36	.826-1.417	40-56	1.575-2.205	57-72	2.244-2.835
12,01-14,00	.473-.551	22-37	.866-1.457	43-59	1.693-2.323	68-83	2.677-3.268
14,01-16,00	.552-.630	23-39	.906-1.535	44-60	1.732-2.362	76-92	2.992-3.622

Da utilizzare esclusivamente con attacco cilindrico (R1).



Seco Universal – Punta a diametro singolo

Le punte in metallo duro integrale Seco Universal sono una soluzione conveniente e versatile che si adatta perfettamente alla produzione di lotti di piccole e medie dimensioni. Le punte Seco Universal sono adatte per la maggior parte delle applicazioni in tutti i segmenti industriali.

- Geometria multi-uso a 4 faccette con eccellenti proprietà di centraggio
- Rivestimento in TiAlN altamente resistente all'usura che garantisce una lunga durata dell'utensile
- Utilizzabile in combinazione con maschi Threadmaster™ Tap e in operazioni di pre-foratura con Nanofix™/Precimaster™ Plus

SD1103

Profondità di foratura ~ 3 x D – Misure metriche/Pollici

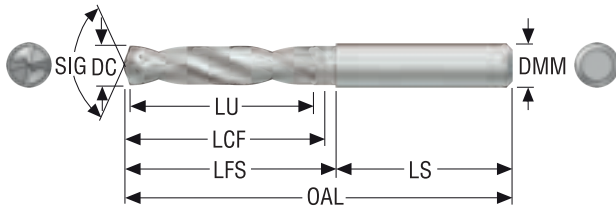

- Codolo cilindrico DIN 6537A
- Tolleranza DC m7
- Adduzione refrigerante esterna
- Per i parametri di taglio raccomandati, vedere pagina(e) 140
- Per i diametri intermedi, utilizzare MyDesign.

Codice di ordinazione	Codice prodotto	DC	LU	OAL	LFS	LS	LCF	DMM	Angolo di punta	Rivestimento	Tolleranza foro
		mm Inch	mm Inch	mm Inch	mm Inch	mm Inch	mm Inch	mm Inch			
SD1103-0300-014-06R1 SD_DRILL_3.0MM_3XD	02898974	3,0 0.118	14,0 0.551	62,0 2.441	26,0 1.024	36,0 1.417	20,0 0.787	6,0 0.236	140°	TiAlN	IT9
SD1103-0310-014-06R1 SD_DRILL_3.1MM_3XD	02898975	3,1 0.122	14,0 0.551	62,0 2.441	26,0 1.024	36,0 1.417	20,0 0.787	6,0 0.236	140°	TiAlN	IT9
SD1103-0318-014-06R1 SD_DRILL_1/8_3XD	02898976	3,175 0.125	14,0 0.551	62,0 2.441	26,0 1.024	36,0 1.417	20,0 0.787	6,0 0.236	140°	TiAlN	IT9
SD1103-0320-014-06R1 SD_DRILL_3.2MM_3XD	02898977	3,2 0.126	14,0 0.551	62,0 2.441	26,0 1.024	36,0 1.417	20,0 0.787	6,0 0.236	140°	TiAlN	IT9
SD1103-0325-014-06R1 SD_DRILL_3.25MM_3XD	02898978	3,25 0.128	14,0 0.551	62,0 2.441	26,0 1.024	36,0 1.417	20,0 0.787	6,0 0.236	140°	TiAlN	IT9
SD1103-0330-014-06R1 SD_DRILL_3.3MM_3XD	02898979	3,3 0.130	14,0 0.551	62,0 2.441	26,0 1.024	36,0 1.417	20,0 0.787	6,0 0.236	140°	TiAlN	IT9
SD1103-0340-014-06R1 SD_DRILL_3.4MM_3XD	02898980	3,4 0.134	14,0 0.551	62,0 2.441	26,0 1.024	36,0 1.417	20,0 0.787	6,0 0.236	140°	TiAlN	IT9
SD1103-0350-014-06R1 SD_DRILL_3.5MM_3XD	02898981	3,5 0.138	14,0 0.551	62,0 2.441	26,0 1.024	36,0 1.417	20,0 0.787	6,0 0.236	140°	TiAlN	IT9
SD1103-0357-014-06R1 SD_DRILL_9/64_3XD	02898982	3,572 0.141	14,0 0.551	62,0 2.441	26,0 1.024	36,0 1.417	20,0 0.787	6,0 0.236	140°	TiAlN	IT9
SD1103-0360-014-06R1 SD_DRILL_3.6MM_3XD	02898983	3,6 0.142	14,0 0.551	62,0 2.441	26,0 1.024	36,0 1.417	20,0 0.787	6,0 0.236	140°	TiAlN	IT9
SD1103-0365-014-06R1 SD_DRILL_3.65MM_3XD	02898984	3,65 0.144	14,0 0.551	62,0 2.441	26,0 1.024	36,0 1.417	20,0 0.787	6,0 0.236	140°	TiAlN	IT9
SD1103-0370-014-06R1 SD_DRILL_3.7MM_3XD	02898985	3,7 0.146	14,0 0.551	62,0 2.441	26,0 1.024	36,0 1.417	20,0 0.787	6,0 0.236	140°	TiAlN	IT9
SD1103-0380-017-06R1 SD_DRILL_3.8MM_3XD	02898986	3,8 0.150	17,0 0.669	66,0 2.598	30,0 1.181	36,0 1.417	24,0 0.945	6,0 0.236	140°	TiAlN	IT9
SD1103-0390-017-06R1 SD_DRILL_3.9MM_3XD	02898987	3,9 0.154	17,0 0.669	66,0 2.598	30,0 1.181	36,0 1.417	24,0 0.945	6,0 0.236	140°	TiAlN	IT9
SD1103-0397-017-06R1 SD_DRILL_5/32_3XD	02898988	3,969 0.156	17,0 0.669	66,0 2.598	30,0 1.181	36,0 1.417	24,0 0.945	6,0 0.236	140°	TiAlN	IT9
SD1103-0400-017-06R1 SD_DRILL_4.0MM_3XD	02898989	4,0 0.157	17,0 0.669	66,0 2.598	30,0 1.181	36,0 1.417	24,0 0.945	6,0 0.236	140°	TiAlN	IT9
SD1103-0410-017-06R1 SD_DRILL_4.1MM_3XD	02898990	4,1 0.161	17,0 0.669	66,0 2.598	30,0 1.181	36,0 1.417	24,0 0.945	6,0 0.236	140°	TiAlN	IT9
SD1103-0420-017-06R1 SD_DRILL_4.2MM_3XD	02898991	4,2 0.165	17,0 0.669	66,0 2.598	30,0 1.181	36,0 1.417	24,0 0.945	6,0 0.236	140°	TiAlN	IT9
SD1103-0430-017-06R1 SD_DRILL_4.3MM_3XD	02898992	4,3 0.169	17,0 0.669	66,0 2.598	30,0 1.181	36,0 1.417	24,0 0.945	6,0 0.236	140°	TiAlN	IT9
SD1103-0437-017-06R1 SD_DRILL_11/64_3XD	02898993	4,366 0.172	17,0 0.669	66,0 2.598	30,0 1.181	36,0 1.417	24,0 0.945	6,0 0.236	140°	TiAlN	IT9
SD1103-0440-017-06R1 SD_DRILL_4.4MM_3XD	02898994	4,4 0.173	17,0 0.669	66,0 2.598	30,0 1.181	36,0 1.417	24,0 0.945	6,0 0.236	140°	TiAlN	IT9

Introduzione

Foratura

Alesatura

Barenatura

Allegato

Codice di ordinazione	Codice prodotto	DC	LU	OAL	LFS	LS	LCF	DMM	Angolo di punta	Rivestimento	Tolleranza foro
		mm Inch	mm Inch	mm Inch	mm Inch	mm Inch	mm Inch	mm Inch			
SD1103-0450-017-06R1 SD_DRILL_4.5MM_3XD	02898995	4,5 0.177	17,0 0.669	66,0 2.598	30,0 1.181	36,0 1.417	24,0 0.945	6,0 0.236	140°	TiAIN	IT9
SD1103-0460-017-06R1 SD_DRILL_4.6MM_3XD	02898996	4,6 0.181	17,0 0.669	66,0 2.598	30,0 1.181	36,0 1.417	24,0 0.945	6,0 0.236	140°	TiAIN	IT9
SD1103-0465-017-06R1 SD_DRILL_4.65MM_3XD	02898997	4,65 0.183	17,0 0.669	66,0 2.598	30,0 1.181	36,0 1.417	24,0 0.945	6,0 0.236	140°	TiAIN	IT9
SD1103-0470-017-06R1 SD_DRILL_4.7MM_3XD	02898998	4,7 0.185	17,0 0.669	66,0 2.598	30,0 1.181	36,0 1.417	24,0 0.945	6,0 0.236	140°	TiAIN	IT9
SD1103-0476-020-06R1 SD_DRILL_3/16_3XD	02898999	4,763 0.188	20,0 0.787	66,0 2.598	30,0 1.181	36,0 1.417	28,0 1.102	6,0 0.236	140°	TiAIN	IT9
SD1103-0480-020-06R1 SD_DRILL_4.8MM_3XD	02899000	4,8 0.189	20,0 0.787	66,0 2.598	30,0 1.181	36,0 1.417	28,0 1.102	6,0 0.236	140°	TiAIN	IT9
SD1103-0490-020-06R1 SD_DRILL_4.9MM_3XD	02899001	4,9 0.193	20,0 0.787	66,0 2.598	30,0 1.181	36,0 1.417	28,0 1.102	6,0 0.236	140°	TiAIN	IT9
SD1103-0500-020-06R1 SD_DRILL_5.0MM_3XD	02899002	5,0 0.197	20,0 0.787	66,0 2.598	30,0 1.181	36,0 1.417	28,0 1.102	6,0 0.236	140°	TiAIN	IT9
SD1103-0510-020-06R1 SD_DRILL_5.1MM_3XD	02899003	5,1 0.201	20,0 0.787	66,0 2.598	30,0 1.181	36,0 1.417	28,0 1.102	6,0 0.236	140°	TiAIN	IT9
SD1103-0516-020-06R1 SD_DRILL_13/64_3XD	02899004	5,159 0.203	20,0 0.787	66,0 2.598	30,0 1.181	36,0 1.417	28,0 1.102	6,0 0.236	140°	TiAIN	IT9
SD1103-0520-020-06R1 SD_DRILL_5.2MM_3XD	02899005	5,2 0.205	20,0 0.787	66,0 2.598	30,0 1.181	36,0 1.417	28,0 1.102	6,0 0.236	140°	TiAIN	IT9
SD1103-0530-020-06R1 SD_DRILL_5.3MM_3XD	02899006	5,3 0.209	20,0 0.787	66,0 2.598	30,0 1.181	36,0 1.417	28,0 1.102	6,0 0.236	140°	TiAIN	IT9
SD1103-0540-020-06R1 SD_DRILL_5.4MM_3XD	02899007	5,4 0.213	20,0 0.787	66,0 2.598	30,0 1.181	36,0 1.417	28,0 1.102	6,0 0.236	140°	TiAIN	IT9
SD1103-0550-020-06R1 SD_DRILL_5.5MM_3XD	02899008	5,5 0.217	20,0 0.787	66,0 2.598	30,0 1.181	36,0 1.417	28,0 1.102	6,0 0.236	140°	TiAIN	IT9
SD1103-0555-020-06R1 SD_DRILL_5.55MM_3XD	02899009	5,55 0.219	20,0 0.787	66,0 2.598	30,0 1.181	36,0 1.417	28,0 1.102	6,0 0.236	140°	TiAIN	IT9
SD1103-0556-020-06R1 SD_DRILL_7/32_3XD	02899010	5,556 0.219	20,0 0.787	66,0 2.598	30,0 1.181	36,0 1.417	28,0 1.102	6,0 0.236	140°	TiAIN	IT9
SD1103-0560-020-06R1 SD_DRILL_5.6MM_3XD	02899011	5,6 0.220	20,0 0.787	66,0 2.598	30,0 1.181	36,0 1.417	28,0 1.102	6,0 0.236	140°	TiAIN	IT9
SD1103-0570-020-06R1 SD_DRILL_5.7MM_3XD	02899012	5,7 0.224	20,0 0.787	66,0 2.598	30,0 1.181	36,0 1.417	28,0 1.102	6,0 0.236	140°	TiAIN	IT9
SD1103-0580-020-06R1 SD_DRILL_5.8MM_3XD	02899013	5,8 0.228	20,0 0.787	66,0 2.598	30,0 1.181	36,0 1.417	28,0 1.102	6,0 0.236	140°	TiAIN	IT9
SD1103-0590-020-06R1 SD_DRILL_5.9MM_3XD	02899014	5,9 0.232	20,0 0.787	66,0 2.598	30,0 1.181	36,0 1.417	28,0 1.102	6,0 0.236	140°	TiAIN	IT9
SD1103-0595-020-06R1 SD_DRILL_15/64_3XD	02899015	5,953 0.234	20,0 0.787	66,0 2.598	30,0 1.181	36,0 1.417	28,0 1.102	6,0 0.236	140°	TiAIN	IT9
SD1103-0600-020-06R1 SD_DRILL_6.0MM_3XD	02899016	6,0 0.236	20,0 0.787	66,0 2.598	30,0 1.181	36,0 1.417	28,0 1.102	6,0 0.236	140°	TiAIN	IT9
SD1103-0610-024-08R1 SD_DRILL_6.1MM_3XD	02899017	6,1 0.240	24,0 0.945	79,0 3.110	43,0 1.693	36,0 1.417	34,0 1.339	8,0 0.315	140°	TiAIN	IT9
SD1103-0620-024-08R1 SD_DRILL_6.2MM_3XD	02899018	6,2 0.244	24,0 0.945	79,0 3.110	43,0 1.693	36,0 1.417	34,0 1.339	8,0 0.315	140°	TiAIN	IT9
SD1103-0630-024-08R1 SD_DRILL_6.3MM_3XD	02899019	6,3 0.248	24,0 0.945	79,0 3.110	43,0 1.693	36,0 1.417	34,0 1.339	8,0 0.315	140°	TiAIN	IT9
SD1103-0635-024-08R1 SD_DRILL_1/4_3XD	02899020	6,35 0.250	24,0 0.945	79,0 3.110	43,0 1.693	36,0 1.417	34,0 1.339	8,0 0.315	140°	TiAIN	IT9
SD1103-0640-024-08R1 SD_DRILL_6.4MM_3XD	02899021	6,4 0.252	24,0 0.945	79,0 3.110	43,0 1.693	36,0 1.417	34,0 1.339	8,0 0.315	140°	TiAIN	IT9
SD1103-0650-024-08R1 SD_DRILL_6.5MM_3XD	02899022	6,5 0.256	24,0 0.945	79,0 3.110	43,0 1.693	36,0 1.417	34,0 1.339	8,0 0.315	140°	TiAIN	IT9
SD1103-0660-024-08R1 SD_DRILL_6.6MM_3XD	02899024	6,6 0.260	24,0 0.945	79,0 3.110	43,0 1.693	36,0 1.417	34,0 1.339	8,0 0.315	140°	TiAIN	IT9
SD1103-0675-024-08R1 SD_DRILL_17/64_3XD	02899025	6,747 0.266	24,0 0.945	79,0 3.110	43,0 1.693	36,0 1.417	34,0 1.339	8,0 0.315	140°	TiAIN	IT9
SD1103-0680-024-08R1 SD_DRILL_6.8MM_3XD	02899026	6,8 0.268	24,0 0.945	79,0 3.110	43,0 1.693	36,0 1.417	34,0 1.339	8,0 0.315	140°	TiAIN	IT9

Codice di ordinazione	Codice prodotto	DC	LU	OAL	LFS	LS	LCF	DMM	Angolo di punta	Rivestimento	Tolleranza foro
		mm Inch	mm Inch	mm Inch	mm Inch	mm Inch	mm Inch	mm Inch			
SD1103-0690-024-08R1 SD_DRILL_6.9MM_3XD	02899027	6,9 0.272	24,0 0.945	79,0 3.110	43,0 1.693	36,0 1.417	34,0 1.339	8,0 0.315	140°	TiAIN	IT9
SD1103-0700-024-08R1 SD_DRILL_7.0MM_3XD	02899028	7,0 0.276	24,0 0.945	79,0 3.110	43,0 1.693	36,0 1.417	34,0 1.339	8,0 0.315	140°	TiAIN	IT9
SD1103-0710-029-08R1 SD_DRILL_7.1MM_3XD	02899029	7,1 0.280	29,0 1.142	79,0 3.110	43,0 1.693	36,0 1.417	41,0 1.614	8,0 0.315	140°	TiAIN	IT9
SD1103-0714-029-08R1 SD_DRILL_9/32_3XD	02899030	7,144 0.281	29,0 1.142	79,0 3.110	43,0 1.693	36,0 1.417	41,0 1.614	8,0 0.315	140°	TiAIN	IT9
SD1103-0720-029-08R1 SD_DRILL_7.2MM_3XD	02899031	7,2 0.283	29,0 1.142	79,0 3.110	43,0 1.693	36,0 1.417	41,0 1.614	8,0 0.315	140°	TiAIN	IT9
SD1103-0730-029-08R1 SD_DRILL_7.3MM_3XD	02899032	7,3 0.287	29,0 1.142	79,0 3.110	43,0 1.693	36,0 1.417	41,0 1.614	8,0 0.315	140°	TiAIN	IT9
SD1103-0740-029-08R1 SD_DRILL_7.4MM_3XD	02899033	7,4 0.291	29,0 1.142	79,0 3.110	43,0 1.693	36,0 1.417	41,0 1.614	8,0 0.315	140°	TiAIN	IT9
SD1103-0750-029-08R1 SD_DRILL_7.5MM_3XD	02899034	7,5 0.295	29,0 1.142	79,0 3.110	43,0 1.693	36,0 1.417	41,0 1.614	8,0 0.315	140°	TiAIN	IT9
SD1103-0754-029-08R1 SD_DRILL_19/64_3XD	02899035	7,541 0.297	29,0 1.142	79,0 3.110	43,0 1.693	36,0 1.417	41,0 1.614	8,0 0.315	140°	TiAIN	IT9
SD1103-0755-029-08R1 SD_DRILL_7.55MM_3XD	02899036	7,55 0.297	29,0 1.142	79,0 3.110	43,0 1.693	36,0 1.417	41,0 1.614	8,0 0.315	140°	TiAIN	IT9
SD1103-0760-029-08R1 SD_DRILL_7.6MM_3XD	02899037	7,6 0.299	29,0 1.142	79,0 3.110	43,0 1.693	36,0 1.417	41,0 1.614	8,0 0.315	140°	TiAIN	IT9
SD1103-0770-029-08R1 SD_DRILL_7.7MM_3XD	02899038	7,7 0.303	29,0 1.142	79,0 3.110	43,0 1.693	36,0 1.417	41,0 1.614	8,0 0.315	140°	TiAIN	IT9
SD1103-0780-029-08R1 SD_DRILL_7.8MM_3XD	02899040	7,8 0.307	29,0 1.142	79,0 3.110	43,0 1.693	36,0 1.417	41,0 1.614	8,0 0.315	140°	TiAIN	IT9
SD1103-0790-029-08R1 SD_DRILL_7.9MM_3XD	02899041	7,9 0.311	29,0 1.142	79,0 3.110	43,0 1.693	36,0 1.417	41,0 1.614	8,0 0.315	140°	TiAIN	IT9
SD1103-0794-029-08R1 SD_DRILL_5/16_3XD	02899042	7,938 0.313	29,0 1.142	79,0 3.110	43,0 1.693	36,0 1.417	41,0 1.614	8,0 0.315	140°	TiAIN	IT9
SD1103-0800-029-08R1 SD_DRILL_8.0MM_3XD	02899043	8,0 0.315	29,0 1.142	79,0 3.110	43,0 1.693	36,0 1.417	41,0 1.614	8,0 0.315	140°	TiAIN	IT9
SD1103-0810-035-10R1 SD_DRILL_8.1MM_3XD	02899044	8,1 0.319	35,0 1.378	89,0 3.504	49,0 1.929	40,0 1.575	47,0 1.850	10,0 0.394	140°	TiAIN	IT9
SD1103-0820-035-10R1 SD_DRILL_8.2MM_3XD	02899045	8,2 0.323	35,0 1.378	89,0 3.504	49,0 1.929	40,0 1.575	47,0 1.850	10,0 0.394	140°	TiAIN	IT9
SD1103-0830-035-10R1 SD_DRILL_8.3MM_3XD	02899046	8,3 0.327	35,0 1.378	89,0 3.504	49,0 1.929	40,0 1.575	47,0 1.850	10,0 0.394	140°	TiAIN	IT9
SD1103-0833-035-10R1 SD_DRILL_21/64_3XD	02899047	8,334 0.328	35,0 1.378	89,0 3.504	49,0 1.929	40,0 1.575	47,0 1.850	10,0 0.394	140°	TiAIN	IT9
SD1103-0840-035-10R1 SD_DRILL_8.4MM_3XD	02899048	8,4 0.331	35,0 1.378	89,0 3.504	49,0 1.929	40,0 1.575	47,0 1.850	10,0 0.394	140°	TiAIN	IT9
SD1103-0850-035-10R1 SD_DRILL_8.5MM_3XD	02899049	8,5 0.335	35,0 1.378	89,0 3.504	49,0 1.929	40,0 1.575	47,0 1.850	10,0 0.394	140°	TiAIN	IT9
SD1103-0860-035-10R1 SD_DRILL_8.6MM_3XD	02899050	8,6 0.339	35,0 1.378	89,0 3.504	49,0 1.929	40,0 1.575	47,0 1.850	10,0 0.394	140°	TiAIN	IT9
SD1103-0870-035-10R1 SD_DRILL_8.7MM_3XD	02899051	8,7 0.343	35,0 1.378	89,0 3.504	49,0 1.929	40,0 1.575	47,0 1.850	10,0 0.394	140°	TiAIN	IT9
SD1103-0873-035-10R1 SD_DRILL_11/32_3XD	02899052	8,731 0.344	35,0 1.378	89,0 3.504	49,0 1.929	40,0 1.575	47,0 1.850	10,0 0.394	140°	TiAIN	IT9
SD1103-0880-035-10R1 SD_DRILL_8.8MM_3XD	02899053	8,8 0.346	35,0 1.378	89,0 3.504	49,0 1.929	40,0 1.575	47,0 1.850	10,0 0.394	140°	TiAIN	IT9
SD1103-0890-035-10R1 SD_DRILL_8.9MM_3XD	02899054	8,9 0.350	35,0 1.378	89,0 3.504	49,0 1.929	40,0 1.575	47,0 1.850	10,0 0.394	140°	TiAIN	IT9
SD1103-0900-035-10R1 SD_DRILL_9.0MM_3XD	02899055	9,0 0.354	35,0 1.378	89,0 3.504	49,0 1.929	40,0 1.575	47,0 1.850	10,0 0.394	140°	TiAIN	IT9
SD1103-0910-035-10R1 SD_DRILL_9.1MM_3XD	02899056	9,1 0.358	35,0 1.378	89,0 3.504	49,0 1.929	40,0 1.575	47,0 1.850	10,0 0.394	140°	TiAIN	IT9
SD1103-0913-035-10R1 SD_DRILL_23/64_3XD	02899058	9,128 0.359	35,0 1.378	89,0 3.504	49,0 1.929	40,0 1.575	47,0 1.850	10,0 0.394	140°	TiAIN	IT9
SD1103-0920-035-10R1 SD_DRILL_9.2MM_3XD	02899059	9,2 0.362	35,0 1.378	89,0 3.504	49,0 1.929	40,0 1.575	47,0 1.850	10,0 0.394	140°	TiAIN	IT9

Introduzione

Foratura

Alesatura

Barenatura

Allegato

Codice di ordinazione	Codice prodotto	DC	LU	OAL	LFS	LS	LCF	DMM	Angolo di punta	Rivestimento	Tolleranza foro		
		mm Inch	mm Inch	mm Inch	mm Inch	mm Inch	mm Inch	mm Inch					
Introduzione	SD1103-0930-035-10R1 SD_DRILL_9.3MM_3XD	02899060	9,3 0.366	35,0 1.378	89,0 3.504	49,0 1.929	40,0 1.575	47,0 1.850	10,0 0.394	140°	TiAIN	IT9	
	SD1103-0940-035-10R1 SD_DRILL_9.4MM_3XD	02899061	9,4 0.370	35,0 1.378	89,0 3.504	49,0 1.929	40,0 1.575	47,0 1.850	10,0 0.394	140°	TiAIN	IT9	
	SD1103-0950-035-10R1 SD_DRILL_9.5MM_3XD	02899062	9,5 0.374	35,0 1.378	89,0 3.504	49,0 1.929	40,0 1.575	47,0 1.850	10,0 0.394	140°	TiAIN	IT9	
	SD1103-0953-035-10R1 SD_DRILL_3/8_3XD	02899063	9,525 0.375	35,0 1.378	89,0 3.504	49,0 1.929	40,0 1.575	47,0 1.850	10,0 0.394	140°	TiAIN	IT9	
Foratura	SD1103-0955-035-10R1 SD_DRILL_9.55MM_3XD	02899064	9,55 0.376	35,0 1.378	89,0 3.504	49,0 1.929	40,0 1.575	47,0 1.850	10,0 0.394	140°	TiAIN	IT9	
	SD1103-0960-035-10R1 SD_DRILL_9.6MM_3XD	02899065	9,6 0.378	35,0 1.378	89,0 3.504	49,0 1.929	40,0 1.575	47,0 1.850	10,0 0.394	140°	TiAIN	IT9	
	SD1103-0970-035-10R1 SD_DRILL_9.7MM_3XD	02899066	9,7 0.382	35,0 1.378	89,0 3.504	49,0 1.929	40,0 1.575	47,0 1.850	10,0 0.394	140°	TiAIN	IT9	
	SD1103-0980-035-10R1 SD_DRILL_9.8MM_3XD	02899067	9,8 0.386	35,0 1.378	89,0 3.504	49,0 1.929	40,0 1.575	47,0 1.850	10,0 0.394	140°	TiAIN	IT9	
	SD1103-0990-035-10R1 SD_DRILL_9.9MM_3XD	02899068	9,9 0.390	35,0 1.378	89,0 3.504	49,0 1.929	40,0 1.575	47,0 1.850	10,0 0.394	140°	TiAIN	IT9	
	SD1103-0992-035-10R1 SD_DRILL_25/64_3XD	02899069	9,922 0.391	35,0 1.378	89,0 3.504	49,0 1.929	40,0 1.575	47,0 1.850	10,0 0.394	140°	TiAIN	IT9	
	SD1103-1000-035-10R1 SD_DRILL_10.0MM_3XD	02899070	10,0 0.394	35,0 1.378	89,0 3.504	49,0 1.929	40,0 1.575	47,0 1.850	10,0 0.394	140°	TiAIN	IT9	
	SD1103-1020-040-12R1 SD_DRILL_10.2MM_3XD	02899071	10,2 0.402	40,0 1.575	102,0 4.016	57,0 2.244	45,0 1.772	55,0 2.165	12,0 0.472	140°	TiAIN	IT9	
	SD1103-1032-040-12R1 SD_DRILL_13/32_3XD	02899072	10,319 0.406	40,0 1.575	102,0 4.016	57,0 2.244	45,0 1.772	55,0 2.165	12,0 0.472	140°	TiAIN	IT9	
	SD1103-1040-040-12R1 SD_DRILL_10.4MM_3XD	02899073	10,4 0.409	40,0 1.575	102,0 4.016	57,0 2.244	45,0 1.772	55,0 2.165	12,0 0.472	140°	TiAIN	IT9	
Alesatura	SD1103-1050-040-12R1 SD_DRILL_10.5MM_3XD	02899074	10,5 0.413	40,0 1.575	102,0 4.016	57,0 2.244	45,0 1.772	55,0 2.165	12,0 0.472	140°	TiAIN	IT9	
	SD1103-1060-040-12R1 SD_DRILL_10.6MM_3XD	02899075	10,6 0.417	40,0 1.575	102,0 4.016	57,0 2.244	45,0 1.772	55,0 2.165	12,0 0.472	140°	TiAIN	IT9	
	SD1103-1072-040-12R1 SD_DRILL_27/64_3XD	02899076	10,716 0.422	40,0 1.575	102,0 4.016	57,0 2.244	45,0 1.772	55,0 2.165	12,0 0.472	140°	TiAIN	IT9	
	SD1103-1080-040-12R1 SD_DRILL_10.8MM_3XD	02899077	10,8 0.425	40,0 1.575	102,0 4.016	57,0 2.244	45,0 1.772	55,0 2.165	12,0 0.472	140°	TiAIN	IT9	
	SD1103-1090-040-12R1 SD_DRILL_10.9MM_3XD	02899078	10,9 0.429	40,0 1.575	102,0 4.016	57,0 2.244	45,0 1.772	55,0 2.165	12,0 0.472	140°	TiAIN	IT9	
	SD1103-1100-040-12R1 SD_DRILL_11.0MM_3XD	02899079	11,0 0.433	40,0 1.575	102,0 4.016	57,0 2.244	45,0 1.772	55,0 2.165	12,0 0.472	140°	TiAIN	IT9	
	SD1103-1110-040-12R1 SD_DRILL_11.1MM_3XD	02899080	11,1 0.437	40,0 1.575	102,0 4.016	57,0 2.244	45,0 1.772	55,0 2.165	12,0 0.472	140°	TiAIN	IT9	
	SD1103-1111-040-12R1 SD_DRILL_7/16_3XD	02899081	11,113 0.438	40,0 1.575	102,0 4.016	57,0 2.244	45,0 1.772	55,0 2.165	12,0 0.472	140°	TiAIN	IT9	
	SD1103-1120-040-12R1 SD_DRILL_11.2MM_3XD	02899082	11,2 0.441	40,0 1.575	102,0 4.016	57,0 2.244	45,0 1.772	55,0 2.165	12,0 0.472	140°	TiAIN	IT9	
	SD1103-1130-040-12R1 SD_DRILL_11.3MM_3XD	02899083	11,3 0.445	40,0 1.575	102,0 4.016	57,0 2.244	45,0 1.772	55,0 2.165	12,0 0.472	140°	TiAIN	IT9	
Barenatura	SD1103-1140-040-12R1 SD_DRILL_11.4MM_3XD	02899084	11,4 0.449	40,0 1.575	102,0 4.016	57,0 2.244	45,0 1.772	55,0 2.165	12,0 0.472	140°	TiAIN	IT9	
	SD1103-1150-040-12R1 SD_DRILL_11.5MM_3XD	02899085	11,5 0.453	40,0 1.575	102,0 4.016	57,0 2.244	45,0 1.772	55,0 2.165	12,0 0.472	140°	TiAIN	IT9	
	SD1103-1151-040-12R1 SD_DRILL_29/64_3XD	02899086	11,509 0.453	40,0 1.575	102,0 4.016	57,0 2.244	45,0 1.772	55,0 2.165	12,0 0.472	140°	TiAIN	IT9	
	SD1103-1155-040-12R1 SD_DRILL_11.55MM_3XD	02899087	11,55 0.455	40,0 1.575	102,0 4.016	57,0 2.244	45,0 1.772	55,0 2.165	12,0 0.472	140°	TiAIN	IT9	
	SD1103-1160-040-12R1 SD_DRILL_11.6MM_3XD	02899088	11,6 0.457	40,0 1.575	102,0 4.016	57,0 2.244	45,0 1.772	55,0 2.165	12,0 0.472	140°	TiAIN	IT9	
	SD1103-1170-040-12R1 SD_DRILL_11.7MM_3XD	02899089	11,7 0.461	40,0 1.575	102,0 4.016	57,0 2.244	45,0 1.772	55,0 2.165	12,0 0.472	140°	TiAIN	IT9	
	SD1103-1180-040-12R1 SD_DRILL_11.8MM_3XD	02899090	11,8 0.465	40,0 1.575	102,0 4.016	57,0 2.244	45,0 1.772	55,0 2.165	12,0 0.472	140°	TiAIN	IT9	
	Allegato												

Codice di ordinazione	Codice prodotto	DC	LU	OAL	LFS	LS	LCF	DMM	Angolo di punta	Rivestimento	Tolleranza foro
		mm Inch	mm Inch	mm Inch	mm Inch	mm Inch	mm Inch	mm Inch			
SD1103-1190-040-12R1 SD_DRILL_11.9MM_3XD	02899091	11,9 0.469	40,0 1.575	102,0 4.016	57,0 2.244	45,0 1.772	55,0 2.165	12,0 0.472	140°	TiAIN	IT9
SD1103-1191-040-12R1 SD_DRILL_15/32_3XD	02899092	11,906 0.469	40,0 1.575	102,0 4.016	57,0 2.244	45,0 1.772	55,0 2.165	12,0 0.472	140°	TiAIN	IT9
SD1103-1200-040-12R1 SD_DRILL_12.0MM_3XD	02899093	12,0 0.472	40,0 1.575	102,0 4.016	57,0 2.244	45,0 1.772	55,0 2.165	12,0 0.472	140°	TiAIN	IT9
SD1103-1210-043-14R1 SD_DRILL_12.1MM_3XD	02899094	12,1 0.476	43,0 1.693	107,0 4.213	62,0 2.441	45,0 1.772	60,0 2.362	14,0 0.551	140°	TiAIN	IT9
SD1103-1220-043-14R1 SD_DRILL_12.2MM_3XD	02899095	12,2 0.480	43,0 1.693	107,0 4.213	62,0 2.441	45,0 1.772	60,0 2.362	14,0 0.551	140°	TiAIN	IT9
SD1103-1230-043-14R1 SD_DRILL_31/64_3XD	02899096	12,303 0.484	43,0 1.693	107,0 4.213	62,0 2.441	45,0 1.772	60,0 2.362	14,0 0.551	140°	TiAIN	IT9
SD1103-1240-043-14R1 SD_DRILL_12.4MM_3XD	02899097	12,4 0.488	43,0 1.693	107,0 4.213	62,0 2.441	45,0 1.772	60,0 2.362	14,0 0.551	140°	TiAIN	IT9
SD1103-1250-043-14R1 SD_DRILL_12.5MM_3XD	02899098	12,5 0.492	43,0 1.693	107,0 4.213	62,0 2.441	45,0 1.772	60,0 2.362	14,0 0.551	140°	TiAIN	IT9
SD1103-1260-043-14R1 SD_DRILL_12.6MM_3XD	02899099	12,6 0.496	43,0 1.693	107,0 4.213	62,0 2.441	45,0 1.772	60,0 2.362	14,0 0.551	140°	TiAIN	IT9
SD1103-1270-043-14R1 SD_DRILL_1/2_3XD	02899100	12,7 0.500	43,0 1.693	107,0 4.213	62,0 2.441	45,0 1.772	60,0 2.362	14,0 0.551	140°	TiAIN	IT9
SD1103-1275-043-14R1 SD_DRILL_12.75MM_3XD	02899101	12,75 0.502	43,0 1.693	107,0 4.213	62,0 2.441	45,0 1.772	60,0 2.362	14,0 0.551	140°	TiAIN	IT9
SD1103-1280-043-14R1 SD_DRILL_12.8MM_3XD	02899102	12,8 0.504	43,0 1.693	107,0 4.213	62,0 2.441	45,0 1.772	60,0 2.362	14,0 0.551	140°	TiAIN	IT9
SD1103-1290-043-14R1 SD_DRILL_12.9MM_3XD	02899103	12,9 0.508	43,0 1.693	107,0 4.213	62,0 2.441	45,0 1.772	60,0 2.362	14,0 0.551	140°	TiAIN	IT9
SD1103-1300-043-14R1 SD_DRILL_13.0MM_3XD	02899104	13,0 0.512	43,0 1.693	107,0 4.213	62,0 2.441	45,0 1.772	60,0 2.362	14,0 0.551	140°	TiAIN	IT9
SD1103-1310-043-14R1 SD_DRILL_33/64_3XD	02899105	13,1 0.516	43,0 1.693	107,0 4.213	62,0 2.441	45,0 1.772	60,0 2.362	14,0 0.551	140°	TiAIN	IT9
SD1103-1320-043-14R1 SD_DRILL_13.2MM_3XD	02899106	13,2 0.520	43,0 1.693	107,0 4.213	62,0 2.441	45,0 1.772	60,0 2.362	14,0 0.551	140°	TiAIN	IT9
SD1103-1330-043-14R1 SD_DRILL_13.3MM_3XD	02899107	13,3 0.524	43,0 1.693	107,0 4.213	62,0 2.441	45,0 1.772	60,0 2.362	14,0 0.551	140°	TiAIN	IT9
SD1103-1340-043-14R1 SD_DRILL_13.4MM_3XD	02899108	13,4 0.528	43,0 1.693	107,0 4.213	62,0 2.441	45,0 1.772	60,0 2.362	14,0 0.551	140°	TiAIN	IT9
SD1103-1349-043-14R1 SD_DRILL_17/32_3XD	02899109	13,494 0.531	43,0 1.693	107,0 4.213	62,0 2.441	45,0 1.772	60,0 2.362	14,0 0.551	140°	TiAIN	IT9
SD1103-1350-043-14R1 SD_DRILL_13.5MM_3XD	02899110	13,5 0.531	43,0 1.693	107,0 4.213	62,0 2.441	45,0 1.772	60,0 2.362	14,0 0.551	140°	TiAIN	IT9
SD1103-1360-043-14R1 SD_DRILL_13.6MM_3XD	02899111	13,6 0.535	43,0 1.693	107,0 4.213	62,0 2.441	45,0 1.772	60,0 2.362	14,0 0.551	140°	TiAIN	IT9
SD1103-1370-043-14R1 SD_DRILL_13.7MM_3XD	02899112	13,7 0.539	43,0 1.693	107,0 4.213	62,0 2.441	45,0 1.772	60,0 2.362	14,0 0.551	140°	TiAIN	IT9
SD1103-1380-043-14R1 SD_DRILL_13.8MM_3XD	02899113	13,8 0.543	43,0 1.693	107,0 4.213	62,0 2.441	45,0 1.772	60,0 2.362	14,0 0.551	140°	TiAIN	IT9
SD1103-1390-043-14R1 SD_DRILL_35/64_3XD	02899114	13,9 0.547	43,0 1.693	107,0 4.213	62,0 2.441	45,0 1.772	60,0 2.362	14,0 0.551	140°	TiAIN	IT9
SD1103-1400-043-14R1 SD_DRILL_14.0MM_3XD	02899115	14,0 0.551	43,0 1.693	107,0 4.213	62,0 2.441	45,0 1.772	60,0 2.362	14,0 0.551	140°	TiAIN	IT9
SD1103-1420-045-16R1 SD_DRILL_14.2MM_3XD	02899116	14,2 0.559	45,0 1.772	115,0 4.528	67,0 2.638	48,0 1.890	65,0 2.559	16,0 0.630	140°	TiAIN	IT9
SD1103-1429-045-16R1 SD_DRILL_9/16_3XD	02899117	14,288 0.563	45,0 1.772	115,0 4.528	67,0 2.638	48,0 1.890	65,0 2.559	16,0 0.630	140°	TiAIN	IT9
SD1103-1450-045-16R1 SD_DRILL_14.5MM_3XD	02899119	14,5 0.571	45,0 1.772	115,0 4.528	67,0 2.638	48,0 1.890	65,0 2.559	16,0 0.630	140°	TiAIN	IT9
SD1103-1470-045-16R1 SD_DRILL_14.7MM_3XD	02899120	14,7 0.579	45,0 1.772	115,0 4.528	67,0 2.638	48,0 1.890	65,0 2.559	16,0 0.630	140°	TiAIN	IT9
SD1103-1475-045-16R1 SD_DRILL_14.75MM_3XD	02899121	14,75 0.581	45,0 1.772	115,0 4.528	67,0 2.638	48,0 1.890	65,0 2.559	16,0 0.630	140°	TiAIN	IT9
SD1103-1480-045-16R1 SD_DRILL_14.8MM_3XD	02899122	14,8 0.583	45,0 1.772	115,0 4.528	67,0 2.638	48,0 1.890	65,0 2.559	16,0 0.630	140°	TiAIN	IT9

Introduzione

Foratura

Alesatura

Barenatura

Allegato

Codice di ordinazione	Codice prodotto	DC	LU	OAL	LFS	LS	LCF	DMM	Angolo di punta	Rivestimento	Tolleranza foro
		mm Inch	mm Inch	mm Inch	mm Inch	mm Inch	mm Inch	mm Inch			
SD1103-1500-045-16R1 SD_DRILL_15.0MM_3XD	02899123	15,0 0.591	45,0 1.772	115,0 4.528	67,0 2.638	48,0 1.890	65,0 2.559	16,0 0.630	140°	TiAIN	IT9
SD1103-1510-045-16R1 SD_DRILL_15.1MM_3XD	02899124	15,1 0.594	45,0 1.772	115,0 4.528	67,0 2.638	48,0 1.890	65,0 2.559	16,0 0.630	140°	TiAIN	IT9
SD1103-1530-045-16R1 SD_DRILL_15.3MM_3XD	02899125	15,3 0.602	45,0 1.772	115,0 4.528	67,0 2.638	48,0 1.890	65,0 2.559	16,0 0.630	140°	TiAIN	IT9
SD1103-1550-045-16R1 SD_DRILL_15.5MM_3XD	02899126	15,5 0.610	45,0 1.772	115,0 4.528	67,0 2.638	48,0 1.890	65,0 2.559	16,0 0.630	140°	TiAIN	IT9
SD1103-1570-045-16R1 SD_DRILL_15.7MM_3XD	02899127	15,7 0.618	45,0 1.772	115,0 4.528	67,0 2.638	48,0 1.890	65,0 2.559	16,0 0.630	140°	TiAIN	IT9
SD1103-1580-045-16R1 SD_DRILL_15.8MM_3XD	02899128	15,8 0.622	45,0 1.772	115,0 4.528	67,0 2.638	48,0 1.890	65,0 2.559	16,0 0.630	140°	TiAIN	IT9
SD1103-1588-045-16R1 SD_DRILL_5/8_3XD	02899129	15,875 0.625	45,0 1.772	115,0 4.528	67,0 2.638	48,0 1.890	65,0 2.559	16,0 0.630	140°	TiAIN	IT9
SD1103-1600-045-16R1 SD_DRILL_16.0MM_3XD	02899130	16,0 0.630	45,0 1.772	115,0 4.528	67,0 2.638	48,0 1.890	65,0 2.559	16,0 0.630	140°	TiAIN	IT9
SD1103-1650-051-18R1 SD_DRILL_16.5MM_3XD	02899131	16,5 0.650	51,0 2.008	123,0 4.843	75,0 2.953	48,0 1.890	73,0 2.874	18,0 0.709	140°	TiAIN	IT9
SD1103-1700-051-18R1 SD_DRILL_17.0MM_3XD	02899132	17,0 0.669	51,0 2.008	123,0 4.843	75,0 2.953	48,0 1.890	73,0 2.874	18,0 0.709	140°	TiAIN	IT9
SD1103-1750-051-18R1 SD_DRILL_17.5MM_3XD	02899133	17,5 0.689	51,0 2.008	123,0 4.843	75,0 2.953	48,0 1.890	73,0 2.874	18,0 0.709	140°	TiAIN	IT9
SD1103-1800-051-18R1 SD_DRILL_18.0MM_3XD	02899134	18,0 0.709	51,0 2.008	123,0 4.843	75,0 2.953	48,0 1.890	73,0 2.874	18,0 0.709	140°	TiAIN	IT9
SD1103-1850-055-20R1 SD_DRILL_18.5MM_3XD	02899135	18,5 0.728	55,0 2.165	131,0 5.157	81,0 3.189	50,0 1.969	79,0 3.110	20,0 0.787	140°	TiAIN	IT9
SD1103-1900-055-20R1 SD_DRILL_19.0MM_3XD	02899136	19,0 0.748	55,0 2.165	131,0 5.157	81,0 3.189	50,0 1.969	79,0 3.110	20,0 0.787	140°	TiAIN	IT9
SD1103-1905-055-20R1 SD_DRILL_3/4_3XD	02899137	19,05 0.750	55,0 2.165	131,0 5.157	81,0 3.189	50,0 1.969	79,0 3.110	20,0 0.787	140°	TiAIN	IT9
SD1103-1950-055-20R1 SD_DRILL_19.5MM_3XD	02899138	19,5 0.768	55,0 2.165	131,0 5.157	81,0 3.189	50,0 1.969	79,0 3.110	20,0 0.787	140°	TiAIN	IT9
SD1103-2000-055-20R1 SD_DRILL_20.0MM_3XD	02899139	20,0 0.787	55,0 2.165	131,0 5.157	81,0 3.189	50,0 1.969	79,0 3.110	20,0 0.787	140°	TiAIN	IT9

Introduzione

Foratura

Alesatura

Barenatura

Allegato

SD1103A

Profondità di foratura ~ 3 x D – Misure metriche/Pollici

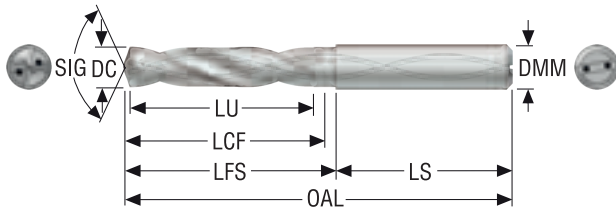

- Codolo cilindrico DIN 6537A
- Tolleranza DC m7
- Adduzione refrigerante interna
- Per i parametri di taglio raccomandati, vedere pagina(e) 141
- Per i diametri intermedi, utilizzare MyDesign.

Codice di ordinazione	Codice prodotto	DC	LU	OAL	LFS	LS	LCF	DMM	Angolo di punta	Rivestimento	Tolleranza foro
		mm Inch	mm Inch	mm Inch	mm Inch	mm Inch	mm Inch	mm Inch			
SD1103A-0300-014-06R1 SD_DRILL_3.0MM_3XD_A	02898244	3,0 0.118	14,0 0.551	62,0 2.441	26,0 1.024	36,0 1.417	20,0 0.787	6,0 0.236	140°	TiAlN	IT9
SD1103A-0310-014-06R1 SD_DRILL_3.1MM_3XD_A	02898245	3,1 0.122	14,0 0.551	62,0 2.441	26,0 1.024	36,0 1.417	20,0 0.787	6,0 0.236	140°	TiAlN	IT9
SD1103A-0318-014-06R1 SD_DRILL_1/8_3XD_A	02898246	3,175 0.125	14,0 0.551	62,0 2.441	26,0 1.024	36,0 1.417	20,0 0.787	6,0 0.236	140°	TiAlN	IT9
SD1103A-0320-014-06R1 SD_DRILL_3.2MM_3XD_A	02898247	3,2 0.126	14,0 0.551	62,0 2.441	26,0 1.024	36,0 1.417	20,0 0.787	6,0 0.236	140°	TiAlN	IT9
SD1103A-0325-014-06R1 SD_DRILL_3.25MM_3XD_A	02898248	3,25 0.128	14,0 0.551	62,0 2.441	26,0 1.024	36,0 1.417	20,0 0.787	6,0 0.236	140°	TiAlN	IT9
SD1103A-0330-014-06R1 SD_DRILL_3.3MM_3XD_A	02898249	3,3 0.130	14,0 0.551	62,0 2.441	26,0 1.024	36,0 1.417	20,0 0.787	6,0 0.236	140°	TiAlN	IT9
SD1103A-0340-014-06R1 SD_DRILL_3.4MM_3XD_A	02898250	3,4 0.134	14,0 0.551	62,0 2.441	26,0 1.024	36,0 1.417	20,0 0.787	6,0 0.236	140°	TiAlN	IT9
SD1103A-0350-014-06R1 SD_DRILL_3.5MM_3XD_A	02898251	3,5 0.138	14,0 0.551	62,0 2.441	26,0 1.024	36,0 1.417	20,0 0.787	6,0 0.236	140°	TiAlN	IT9
SD1103A-0357-014-06R1 SD_DRILL_9/64_3XD_A	02898252	3,572 0.141	14,0 0.551	62,0 2.441	26,0 1.024	36,0 1.417	20,0 0.787	6,0 0.236	140°	TiAlN	IT9
SD1103A-0360-014-06R1 SD_DRILL_3.6MM_3XD_A	02898253	3,6 0.142	14,0 0.551	62,0 2.441	26,0 1.024	36,0 1.417	20,0 0.787	6,0 0.236	140°	TiAlN	IT9
SD1103A-0365-014-06R1 SD_DRILL_3.65MM_3XD_A	02898254	3,65 0.144	14,0 0.551	62,0 2.441	26,0 1.024	36,0 1.417	20,0 0.787	6,0 0.236	140°	TiAlN	IT9
SD1103A-0370-014-06R1 SD_DRILL_3.7MM_3XD_A	02898255	3,7 0.146	14,0 0.551	62,0 2.441	26,0 1.024	36,0 1.417	20,0 0.787	6,0 0.236	140°	TiAlN	IT9
SD1103A-0380-017-06R1 SD_DRILL_3.8MM_3XD_A	02898256	3,8 0.150	17,0 0.669	66,0 2.598	30,0 1.181	36,0 1.417	24,0 0.945	6,0 0.236	140°	TiAlN	IT9
SD1103A-0390-017-06R1 SD_DRILL_3.9MM_3XD_A	02898257	3,9 0.154	17,0 0.669	66,0 2.598	30,0 1.181	36,0 1.417	24,0 0.945	6,0 0.236	140°	TiAlN	IT9
SD1103A-0397-017-06R1 SD_DRILL_5/32_3XD_A	02898258	3,969 0.156	17,0 0.669	66,0 2.598	30,0 1.181	36,0 1.417	24,0 0.945	6,0 0.236	140°	TiAlN	IT9
SD1103A-0400-017-06R1 SD_DRILL_4.0MM_3XD_A	02898259	4,0 0.157	17,0 0.669	66,0 2.598	30,0 1.181	36,0 1.417	24,0 0.945	6,0 0.236	140°	TiAlN	IT9
SD1103A-0410-017-06R1 SD_DRILL_4.1MM_3XD_A	02898260	4,1 0.161	17,0 0.669	66,0 2.598	30,0 1.181	36,0 1.417	24,0 0.945	6,0 0.236	140°	TiAlN	IT9
SD1103A-0420-017-06R1 SD_DRILL_4.2MM_3XD_A	02898261	4,2 0.165	17,0 0.669	66,0 2.598	30,0 1.181	36,0 1.417	24,0 0.945	6,0 0.236	140°	TiAlN	IT9
SD1103A-0430-017-06R1 SD_DRILL_4.3MM_3XD_A	02898262	4,3 0.169	17,0 0.669	66,0 2.598	30,0 1.181	36,0 1.417	24,0 0.945	6,0 0.236	140°	TiAlN	IT9
SD1103A-0437-017-06R1 SD_DRILL_11/64_3XD_A	02898263	4,366 0.172	17,0 0.669	66,0 2.598	30,0 1.181	36,0 1.417	24,0 0.945	6,0 0.236	140°	TiAlN	IT9
SD1103A-0450-017-06R1 SD_DRILL_4.5MM_3XD_A	02898264	4,5 0.177	17,0 0.669	66,0 2.598	30,0 1.181	36,0 1.417	24,0 0.945	6,0 0.236	140°	TiAlN	IT9

	Codice di ordinazione	Codice prodotto	DC	LU	OAL	LFS	LS	LCF	DMM	Angolo di punta	Rivestimento	Tolleranza foro
			mm Inch	mm Inch	mm Inch	mm Inch	mm Inch	mm Inch	mm Inch			
Introduzione	SD1103A-0460-017-06R1 SD_DRILL_4.6MM_3XD_A	02898265	4,6 0.181	17,0 0.669	66,0 2.598	30,0 1.181	36,0 1.417	24,0 0.945	6,0 0.236	140°	TiAIN	IT9
	SD1103A-0465-017-06R1 SD_DRILL_4.65MM_3XD_A	02898266	4,65 0.183	17,0 0.669	66,0 2.598	30,0 1.181	36,0 1.417	24,0 0.945	6,0 0.236	140°	TiAIN	IT9
	SD1103A-0470-017-06R1 SD_DRILL_4.7MM_3XD_A	02898267	4,7 0.185	17,0 0.669	66,0 2.598	30,0 1.181	36,0 1.417	24,0 0.945	6,0 0.236	140°	TiAIN	IT9
	SD1103A-0476-020-06R1 SD_DRILL_3/16_3XD_A	02898268	4,763 0.188	20,0 0.787	66,0 2.598	30,0 1.181	36,0 1.417	28,0 1.102	6,0 0.236	140°	TiAIN	IT9
Foratura	SD1103A-0480-020-06R1 SD_DRILL_4.8MM_3XD_A	02898269	4,8 0.189	20,0 0.787	66,0 2.598	30,0 1.181	36,0 1.417	28,0 1.102	6,0 0.236	140°	TiAIN	IT9
	SD1103A-0490-020-06R1 SD_DRILL_4.9MM_3XD_A	02898270	4,9 0.193	20,0 0.787	66,0 2.598	30,0 1.181	36,0 1.417	28,0 1.102	6,0 0.236	140°	TiAIN	IT9
	SD1103A-0500-020-06R1 SD_DRILL_5.0MM_3XD_A	02898271	5,0 0.197	20,0 0.787	66,0 2.598	30,0 1.181	36,0 1.417	28,0 1.102	6,0 0.236	140°	TiAIN	IT9
	SD1103A-0510-020-06R1 SD_DRILL_5.1MM_3XD_A	02898272	5,1 0.201	20,0 0.787	66,0 2.598	30,0 1.181	36,0 1.417	28,0 1.102	6,0 0.236	140°	TiAIN	IT9
	SD1103A-0516-020-06R1 SD_DRILL_13/64_3XD_A	02898273	5,159 0.203	20,0 0.787	66,0 2.598	30,0 1.181	36,0 1.417	28,0 1.102	6,0 0.236	140°	TiAIN	IT9
	SD1103A-0520-020-06R1 SD_DRILL_5.2MM_3XD_A	02898275	5,2 0.205	20,0 0.787	66,0 2.598	30,0 1.181	36,0 1.417	28,0 1.102	6,0 0.236	140°	TiAIN	IT9
	SD1103A-0530-020-06R1 SD_DRILL_5.3MM_3XD_A	02898276	5,3 0.209	20,0 0.787	66,0 2.598	30,0 1.181	36,0 1.417	28,0 1.102	6,0 0.236	140°	TiAIN	IT9
	SD1103A-0540-020-06R1 SD_DRILL_5.4MM_3XD_A	02898277	5,4 0.213	20,0 0.787	66,0 2.598	30,0 1.181	36,0 1.417	28,0 1.102	6,0 0.236	140°	TiAIN	IT9
	SD1103A-0550-020-06R1 SD_DRILL_5.5MM_3XD_A	02898278	5,5 0.217	20,0 0.787	66,0 2.598	30,0 1.181	36,0 1.417	28,0 1.102	6,0 0.236	140°	TiAIN	IT9
	SD1103A-0555-020-06R1 SD_DRILL_5.55MM_3XD_A	02898279	5,55 0.219	20,0 0.787	66,0 2.598	30,0 1.181	36,0 1.417	28,0 1.102	6,0 0.236	140°	TiAIN	IT9
	SD1103A-0556-020-06R1 SD_DRILL_7/32_3XD_A	02898280	5,556 0.219	20,0 0.787	66,0 2.598	30,0 1.181	36,0 1.417	28,0 1.102	6,0 0.236	140°	TiAIN	IT9
	SD1103A-0560-020-06R1 SD_DRILL_5.6MM_3XD_A	02898281	5,6 0.220	20,0 0.787	66,0 2.598	30,0 1.181	36,0 1.417	28,0 1.102	6,0 0.236	140°	TiAIN	IT9
	SD1103A-0570-020-06R1 SD_DRILL_5.7MM_3XD_A	02898282	5,7 0.224	20,0 0.787	66,0 2.598	30,0 1.181	36,0 1.417	28,0 1.102	6,0 0.236	140°	TiAIN	IT9
	SD1103A-0580-020-06R1 SD_DRILL_5.8MM_3XD_A	02898283	5,8 0.228	20,0 0.787	66,0 2.598	30,0 1.181	36,0 1.417	28,0 1.102	6,0 0.236	140°	TiAIN	IT9
	SD1103A-0590-020-06R1 SD_DRILL_5.9MM_3XD_A	02898284	5,9 0.232	20,0 0.787	66,0 2.598	30,0 1.181	36,0 1.417	28,0 1.102	6,0 0.236	140°	TiAIN	IT9
	SD1103A-0595-020-06R1 SD_DRILL_15/64_3XD_A	02898285	5,953 0.234	20,0 0.787	66,0 2.598	30,0 1.181	36,0 1.417	28,0 1.102	6,0 0.236	140°	TiAIN	IT9
Barenatura	SD1103A-0600-020-06R1 SD_DRILL_6.0MM_3XD_A	02898286	6,0 0.236	20,0 0.787	66,0 2.598	30,0 1.181	36,0 1.417	28,0 1.102	6,0 0.236	140°	TiAIN	IT9
	SD1103A-0610-024-08R1 SD_DRILL_6.1MM_3XD_A	02898287	6,1 0.240	24,0 0.945	79,0 3.110	43,0 1.693	36,0 1.417	34,0 1.339	8,0 0.315	140°	TiAIN	IT9
	SD1103A-0620-024-08R1 SD_DRILL_6.2MM_3XD_A	02898288	6,2 0.244	24,0 0.945	79,0 3.110	43,0 1.693	36,0 1.417	34,0 1.339	8,0 0.315	140°	TiAIN	IT9
	SD1103A-0630-024-08R1 SD_DRILL_6.3MM_3XD_A	02898289	6,3 0.248	24,0 0.945	79,0 3.110	43,0 1.693	36,0 1.417	34,0 1.339	8,0 0.315	140°	TiAIN	IT9
	SD1103A-0635-024-08R1 SD_DRILL_1/4_3XD_A	02898290	6,35 0.250	24,0 0.945	79,0 3.110	43,0 1.693	36,0 1.417	34,0 1.339	8,0 0.315	140°	TiAIN	IT9
	SD1103A-0640-024-08R1 SD_DRILL_6.4MM_3XD_A	02898291	6,4 0.252	24,0 0.945	79,0 3.110	43,0 1.693	36,0 1.417	34,0 1.339	8,0 0.315	140°	TiAIN	IT9
	SD1103A-0650-024-08R1 SD_DRILL_6.5MM_3XD_A	02898292	6,5 0.256	24,0 0.945	79,0 3.110	43,0 1.693	36,0 1.417	34,0 1.339	8,0 0.315	140°	TiAIN	IT9
	SD1103A-0660-024-08R1 SD_DRILL_6.6MM_3XD_A	02898293	6,6 0.260	24,0 0.945	79,0 3.110	43,0 1.693	36,0 1.417	34,0 1.339	8,0 0.315	140°	TiAIN	IT9
	SD1103A-0670-024-08R1 SD_DRILL_6.7MM_3XD_A	02898294	6,7 0.264	24,0 0.945	79,0 3.110	43,0 1.693	36,0 1.417	34,0 1.339	8,0 0.315	140°	TiAIN	IT9
	SD1103A-0675-024-08R1 SD_DRILL_17/64_3XD_A	02898295	6,747 0.266	24,0 0.945	79,0 3.110	43,0 1.693	36,0 1.417	34,0 1.339	8,0 0.315	140°	TiAIN	IT9
Allegato	SD1103A-0680-024-08R1 SD_DRILL_6.8MM_3XD_A	02898296	6,8 0.268	24,0 0.945	79,0 3.110	43,0 1.693	36,0 1.417	34,0 1.339	8,0 0.315	140°	TiAIN	IT9

Codice di ordinazione	Codice prodotto	DC	LU	OAL	LFS	LS	LCF	DMM	Angolo di punta	Rivestimento	Tolleranza foro
		mm Inch	mm Inch	mm Inch	mm Inch	mm Inch	mm Inch	mm Inch			
SD1103A-0690-024-08R1 SD_DRILL_6.9MM_3XD_A	02898297	6,9 0.272	24,0 0.945	79,0 3.110	43,0 1.693	36,0 1.417	34,0 1.339	8,0 0.315	140°	TiAIN	IT9
SD1103A-0700-024-08R1 SD_DRILL_7.0MM_3XD_A	02898298	7,0 0.276	24,0 0.945	79,0 3.110	43,0 1.693	36,0 1.417	34,0 1.339	8,0 0.315	140°	TiAIN	IT9
SD1103A-0710-029-08R1 SD_DRILL_7.1MM_3XD_A	02898299	7,1 0.280	29,0 1.142	79,0 3.110	43,0 1.693	36,0 1.417	41,0 1.614	8,0 0.315	140°	TiAIN	IT9
SD1103A-0714-029-08R1 SD_DRILL_9/32_3XD_A	02898300	7,144 0.281	29,0 1.142	79,0 3.110	43,0 1.693	36,0 1.417	41,0 1.614	8,0 0.315	140°	TiAIN	IT9
SD1103A-0720-029-08R1 SD_DRILL_7.2MM_3XD_A	02898301	7,2 0.283	29,0 1.142	79,0 3.110	43,0 1.693	36,0 1.417	41,0 1.614	8,0 0.315	140°	TiAIN	IT9
SD1103A-0730-029-08R1 SD_DRILL_7.3MM_3XD_A	02898302	7,3 0.287	29,0 1.142	79,0 3.110	43,0 1.693	36,0 1.417	41,0 1.614	8,0 0.315	140°	TiAIN	IT9
SD1103A-0740-029-08R1 SD_DRILL_7.4MM_3XD_A	02898303	7,4 0.291	29,0 1.142	79,0 3.110	43,0 1.693	36,0 1.417	41,0 1.614	8,0 0.315	140°	TiAIN	IT9
SD1103A-0750-029-08R1 SD_DRILL_7.5MM_3XD_A	02898304	7,5 0.295	29,0 1.142	79,0 3.110	43,0 1.693	36,0 1.417	41,0 1.614	8,0 0.315	140°	TiAIN	IT9
SD1103A-0754-029-08R1 SD_DRILL_19/64_3XD_A	02898305	7,541 0.297	29,0 1.142	79,0 3.110	43,0 1.693	36,0 1.417	41,0 1.614	8,0 0.315	140°	TiAIN	IT9
SD1103A-0755-029-08R1 SD_DRILL_7.55MM_3XD_A	02898306	7,55 0.297	29,0 1.142	79,0 3.110	43,0 1.693	36,0 1.417	41,0 1.614	8,0 0.315	140°	TiAIN	IT9
SD1103A-0760-029-08R1 SD_DRILL_7.6MM_3XD_A	02898307	7,6 0.299	29,0 1.142	79,0 3.110	43,0 1.693	36,0 1.417	41,0 1.614	8,0 0.315	140°	TiAIN	IT9
SD1103A-0770-029-08R1 SD_DRILL_7.7MM_3XD_A	02898308	7,7 0.303	29,0 1.142	79,0 3.110	43,0 1.693	36,0 1.417	41,0 1.614	8,0 0.315	140°	TiAIN	IT9
SD1103A-0780-029-08R1 SD_DRILL_7.8MM_3XD_A	02898309	7,8 0.307	29,0 1.142	79,0 3.110	43,0 1.693	36,0 1.417	41,0 1.614	8,0 0.315	140°	TiAIN	IT9
SD1103A-0790-029-08R1 SD_DRILL_7.9MM_3XD_A	02898310	7,9 0.311	29,0 1.142	79,0 3.110	43,0 1.693	36,0 1.417	41,0 1.614	8,0 0.315	140°	TiAIN	IT9
SD1103A-0794-029-08R1 SD_DRILL_5/16_3XD_A	02898311	7,938 0.313	29,0 1.142	79,0 3.110	43,0 1.693	36,0 1.417	41,0 1.614	8,0 0.315	140°	TiAIN	IT9
SD1103A-0800-029-08R1 SD_DRILL_8.0MM_3XD_A	02898312	8,0 0.315	29,0 1.142	79,0 3.110	43,0 1.693	36,0 1.417	41,0 1.614	8,0 0.315	140°	TiAIN	IT9
SD1103A-0810-035-10R1 SD_DRILL_8.1MM_3XD_A	02898313	8,1 0.319	35,0 1.378	89,0 3.504	49,0 1.929	40,0 1.575	47,0 1.850	10,0 0.394	140°	TiAIN	IT9
SD1103A-0820-035-10R1 SD_DRILL_8.2MM_3XD_A	02898314	8,2 0.323	35,0 1.378	89,0 3.504	49,0 1.929	40,0 1.575	47,0 1.850	10,0 0.394	140°	TiAIN	IT9
SD1103A-0830-035-10R1 SD_DRILL_8.3MM_3XD_A	02898315	8,3 0.327	35,0 1.378	89,0 3.504	49,0 1.929	40,0 1.575	47,0 1.850	10,0 0.394	140°	TiAIN	IT9
SD1103A-0833-035-10R1 SD_DRILL_21/64_3XD_A	02898316	8,334 0.328	35,0 1.378	89,0 3.504	49,0 1.929	40,0 1.575	47,0 1.850	10,0 0.394	140°	TiAIN	IT9
SD1103A-0840-035-10R1 SD_DRILL_8.4MM_3XD_A	02898317	8,4 0.331	35,0 1.378	89,0 3.504	49,0 1.929	40,0 1.575	47,0 1.850	10,0 0.394	140°	TiAIN	IT9
SD1103A-0850-035-10R1 SD_DRILL_8.5MM_3XD_A	02898318	8,5 0.335	35,0 1.378	89,0 3.504	49,0 1.929	40,0 1.575	47,0 1.850	10,0 0.394	140°	TiAIN	IT9
SD1103A-0860-035-10R1 SD_DRILL_8.6MM_3XD_A	02898319	8,6 0.339	35,0 1.378	89,0 3.504	49,0 1.929	40,0 1.575	47,0 1.850	10,0 0.394	140°	TiAIN	IT9
SD1103A-0870-035-10R1 SD_DRILL_8.7MM_3XD_A	02898320	8,7 0.343	35,0 1.378	89,0 3.504	49,0 1.929	40,0 1.575	47,0 1.850	10,0 0.394	140°	TiAIN	IT9
SD1103A-0873-035-10R1 SD_DRILL_11/32_3XD_A	02898321	8,731 0.344	35,0 1.378	89,0 3.504	49,0 1.929	40,0 1.575	47,0 1.850	10,0 0.394	140°	TiAIN	IT9
SD1103A-0880-035-10R1 SD_DRILL_8.8MM_3XD_A	02898322	8,8 0.346	35,0 1.378	89,0 3.504	49,0 1.929	40,0 1.575	47,0 1.850	10,0 0.394	140°	TiAIN	IT9
SD1103A-0890-035-10R1 SD_DRILL_8.9MM_3XD_A	02898323	8,9 0.350	35,0 1.378	89,0 3.504	49,0 1.929	40,0 1.575	47,0 1.850	10,0 0.394	140°	TiAIN	IT9
SD1103A-0900-035-10R1 SD_DRILL_9.0MM_3XD_A	02898324	9,0 0.354	35,0 1.378	89,0 3.504	49,0 1.929	40,0 1.575	47,0 1.850	10,0 0.394	140°	TiAIN	IT9
SD1103A-0910-035-10R1 SD_DRILL_9.1MM_3XD_A	02898325	9,1 0.358	35,0 1.378	89,0 3.504	49,0 1.929	40,0 1.575	47,0 1.850	10,0 0.394	140°	TiAIN	IT9
SD1103A-0913-035-10R1 SD_DRILL_23/64_3XD_A	02898326	9,128 0.359	35,0 1.378	89,0 3.504	49,0 1.929	40,0 1.575	47,0 1.850	10,0 0.394	140°	TiAIN	IT9
SD1103A-0920-035-10R1 SD_DRILL_9.2MM_3XD_A	02898327	9,2 0.362	35,0 1.378	89,0 3.504	49,0 1.929	40,0 1.575	47,0 1.850	10,0 0.394	140°	TiAIN	IT9

Introduzione

Foratura

Alesatura

Barenatura

Allegato

Codice di ordinazione	Codice prodotto	DC	LU	OAL	LFS	LS	LCF	DMM	Angolo di punta	Rivestimento	Tolleranza foro	
		mm Inch	mm Inch	mm Inch	mm Inch	mm Inch	mm Inch	mm Inch				
Introduzione	SD1103A-0930-035-10R1 SD_DRILL_9.3MM_3XD_A	02898328	9,3 0.366	35,0 1.378	89,0 3.504	49,0 1.929	40,0 1.575	47,0 1.850	10,0 0.394	140°	TiAIN	IT9
	SD1103A-0940-035-10R1 SD_DRILL_9.4MM_3XD_A	02898329	9,4 0.370	35,0 1.378	89,0 3.504	49,0 1.929	40,0 1.575	47,0 1.850	10,0 0.394	140°	TiAIN	IT9
	SD1103A-0950-035-10R1 SD_DRILL_9.5MM_3XD_A	02898330	9,5 0.374	35,0 1.378	89,0 3.504	49,0 1.929	40,0 1.575	47,0 1.850	10,0 0.394	140°	TiAIN	IT9
	SD1103A-0953-035-10R1 SD_DRILL_3/8_3XD_A	02898331	9,525 0.375	35,0 1.378	89,0 3.504	49,0 1.929	40,0 1.575	47,0 1.850	10,0 0.394	140°	TiAIN	IT9
	SD1103A-0955-035-10R1 SD_DRILL_9.55MM_3XD_A	02898332	9,55 0.376	35,0 1.378	89,0 3.504	49,0 1.929	40,0 1.575	47,0 1.850	10,0 0.394	140°	TiAIN	IT9
	SD1103A-0960-035-10R1 SD_DRILL_9.6MM_3XD_A	02898333	9,6 0.378	35,0 1.378	89,0 3.504	49,0 1.929	40,0 1.575	47,0 1.850	10,0 0.394	140°	TiAIN	IT9
	SD1103A-0970-035-10R1 SD_DRILL_9.7MM_3XD_A	02898334	9,7 0.382	35,0 1.378	89,0 3.504	49,0 1.929	40,0 1.575	47,0 1.850	10,0 0.394	140°	TiAIN	IT9
	SD1103A-0980-035-10R1 SD_DRILL_9.8MM_3XD_A	02898335	9,8 0.386	35,0 1.378	89,0 3.504	49,0 1.929	40,0 1.575	47,0 1.850	10,0 0.394	140°	TiAIN	IT9
	SD1103A-0990-035-10R1 SD_DRILL_9.9MM_3XD_A	02898336	9,9 0.390	35,0 1.378	89,0 3.504	49,0 1.929	40,0 1.575	47,0 1.850	10,0 0.394	140°	TiAIN	IT9
	SD1103A-0992-035-10R1 SD_DRILL_25/64_3XD_A	02898337	9,922 0.391	35,0 1.378	89,0 3.504	49,0 1.929	40,0 1.575	47,0 1.850	10,0 0.394	140°	TiAIN	IT9
Foratura	SD1103A-1000-035-10R1 SD_DRILL_10.0MM_3XD_A	02898338	10,0 0.394	35,0 1.378	89,0 3.504	49,0 1.929	40,0 1.575	47,0 1.850	10,0 0.394	140°	TiAIN	IT9
	SD1103A-1020-040-12R1 SD_DRILL_10.2MM_3XD_A	02898339	10,2 0.402	40,0 1.575	102,0 4.016	57,0 2.244	45,0 1.772	55,0 2.165	12,0 0.472	140°	TiAIN	IT9
	SD1103A-1032-040-12R1 SD_DRILL_13/32_3XD_A	02898340	10,319 0.406	40,0 1.575	102,0 4.016	57,0 2.244	45,0 1.772	55,0 2.165	12,0 0.472	140°	TiAIN	IT9
	SD1103A-1040-040-12R1 SD_DRILL_10.4MM_3XD_A	02898341	10,4 0.409	40,0 1.575	102,0 4.016	57,0 2.244	45,0 1.772	55,0 2.165	12,0 0.472	140°	TiAIN	IT9
	SD1103A-1050-040-12R1 SD_DRILL_10.5MM_3XD_A	02898342	10,5 0.413	40,0 1.575	102,0 4.016	57,0 2.244	45,0 1.772	55,0 2.165	12,0 0.472	140°	TiAIN	IT9
	SD1103A-1060-040-12R1 SD_DRILL_10.6MM_3XD_A	02898343	10,6 0.417	40,0 1.575	102,0 4.016	57,0 2.244	45,0 1.772	55,0 2.165	12,0 0.472	140°	TiAIN	IT9
	SD1103A-1072-040-12R1 SD_DRILL_27/64_3XD_A	02898344	10,716 0.422	40,0 1.575	102,0 4.016	57,0 2.244	45,0 1.772	55,0 2.165	12,0 0.472	140°	TiAIN	IT9
	SD1103A-1080-040-12R1 SD_DRILL_10.8MM_3XD_A	02898345	10,8 0.425	40,0 1.575	102,0 4.016	57,0 2.244	45,0 1.772	55,0 2.165	12,0 0.472	140°	TiAIN	IT9
	SD1103A-1090-040-12R1 SD_DRILL_10.9MM_3XD_A	02898346	10,9 0.429	40,0 1.575	102,0 4.016	57,0 2.244	45,0 1.772	55,0 2.165	12,0 0.472	140°	TiAIN	IT9
	SD1103A-1100-040-12R1 SD_DRILL_11.0MM_3XD_A	02898347	11,0 0.433	40,0 1.575	102,0 4.016	57,0 2.244	45,0 1.772	55,0 2.165	12,0 0.472	140°	TiAIN	IT9
Alesatura	SD1103A-1110-040-12R1 SD_DRILL_11.1MM_3XD_A	02898348	11,1 0.437	40,0 1.575	102,0 4.016	57,0 2.244	45,0 1.772	55,0 2.165	12,0 0.472	140°	TiAIN	IT9
	SD1103A-1111-040-12R1 SD_DRILL_7/16_3XD_A	02898349	11,113 0.438	40,0 1.575	102,0 4.016	57,0 2.244	45,0 1.772	55,0 2.165	12,0 0.472	140°	TiAIN	IT9
	SD1103A-1120-040-12R1 SD_DRILL_11.2MM_3XD_A	02898350	11,2 0.441	40,0 1.575	102,0 4.016	57,0 2.244	45,0 1.772	55,0 2.165	12,0 0.472	140°	TiAIN	IT9
	SD1103A-1130-040-12R1 SD_DRILL_11.3MM_3XD_A	02898351	11,3 0.445	40,0 1.575	102,0 4.016	57,0 2.244	45,0 1.772	55,0 2.165	12,0 0.472	140°	TiAIN	IT9
	SD1103A-1140-040-12R1 SD_DRILL_11.4MM_3XD_A	02898352	11,4 0.449	40,0 1.575	102,0 4.016	57,0 2.244	45,0 1.772	55,0 2.165	12,0 0.472	140°	TiAIN	IT9
	SD1103A-1150-040-12R1 SD_DRILL_11.5MM_3XD_A	02898353	11,5 0.453	40,0 1.575	102,0 4.016	57,0 2.244	45,0 1.772	55,0 2.165	12,0 0.472	140°	TiAIN	IT9
	SD1103A-1151-040-12R1 SD_DRILL_29/64_3XD_A	02898354	11,509 0.453	40,0 1.575	102,0 4.016	57,0 2.244	45,0 1.772	55,0 2.165	12,0 0.472	140°	TiAIN	IT9
	SD1103A-1155-040-12R1 SD_DRILL_11.55MM_3XD_A	02898355	11,55 0.455	40,0 1.575	102,0 4.016	57,0 2.244	45,0 1.772	55,0 2.165	12,0 0.472	140°	TiAIN	IT9
	SD1103A-1160-040-12R1 SD_DRILL_11.6MM_3XD_A	02898356	11,6 0.457	40,0 1.575	102,0 4.016	57,0 2.244	45,0 1.772	55,0 2.165	12,0 0.472	140°	TiAIN	IT9
	SD1103A-1170-040-12R1 SD_DRILL_11.7MM_3XD_A	02898357	11,7 0.461	40,0 1.575	102,0 4.016	57,0 2.244	45,0 1.772	55,0 2.165	12,0 0.472	140°	TiAIN	IT9
Allegato	SD1103A-1180-040-12R1 SD_DRILL_11.8MM_3XD_A	02898358	11,8 0.465	40,0 1.575	102,0 4.016	57,0 2.244	45,0 1.772	55,0 2.165	12,0 0.472	140°	TiAIN	IT9

Codice di ordinazione	Codice prodotto	DC	LU	OAL	LFS	LS	LCF	DMM	Angolo di punta	Rivestimento	Tolleranza foro
		mm Inch	mm Inch	mm Inch	mm Inch	mm Inch	mm Inch	mm Inch			
SD1103A-1190-040-12R1 SD_DRILL_11.9MM_3XD_A	02898359	11,9 0.469	40,0 1.575	102,0 4.016	57,0 2.244	45,0 1.772	55,0 2.165	12,0 0.472	140°	TiAIN	IT9
SD1103A-1191-040-12R1 SD_DRILL_15/32_3XD_A	02898360	11,906 0.469	40,0 1.575	102,0 4.016	57,0 2.244	45,0 1.772	55,0 2.165	12,0 0.472	140°	TiAIN	IT9
SD1103A-1200-040-12R1 SD_DRILL_12.0MM_3XD_A	02898361	12,0 0.472	40,0 1.575	102,0 4.016	57,0 2.244	45,0 1.772	55,0 2.165	12,0 0.472	140°	TiAIN	IT9
SD1103A-1210-043-14R1 SD_DRILL_12.1MM_3XD_A	02898362	12,1 0.476	43,0 1.693	107,0 4.213	62,0 2.441	45,0 1.772	60,0 2.362	14,0 0.551	140°	TiAIN	IT9
SD1103A-1220-043-14R1 SD_DRILL_12.2MM_3XD_A	02898363	12,2 0.480	43,0 1.693	107,0 4.213	62,0 2.441	45,0 1.772	60,0 2.362	14,0 0.551	140°	TiAIN	IT9
SD1103A-1230-043-14R1 SD_DRILL_31/64_3XD_A	02898364	12,303 0.484	43,0 1.693	107,0 4.213	62,0 2.441	45,0 1.772	60,0 2.362	14,0 0.551	140°	TiAIN	IT9
SD1103A-1240-043-14R1 SD_DRILL_12.4MM_3XD_A	02898365	12,4 0.488	43,0 1.693	107,0 4.213	62,0 2.441	45,0 1.772	60,0 2.362	14,0 0.551	140°	TiAIN	IT9
SD1103A-1250-043-14R1 SD_DRILL_12.5MM_3XD_A	02898366	12,5 0.492	43,0 1.693	107,0 4.213	62,0 2.441	45,0 1.772	60,0 2.362	14,0 0.551	140°	TiAIN	IT9
SD1103A-1260-043-14R1 SD_DRILL_12.6MM_3XD_A	02898367	12,6 0.496	43,0 1.693	107,0 4.213	62,0 2.441	45,0 1.772	60,0 2.362	14,0 0.551	140°	TiAIN	IT9
SD1103A-1270-043-14R1 SD_DRILL_1/2_3XD_A	02898368	12,7 0.500	43,0 1.693	107,0 4.213	62,0 2.441	45,0 1.772	60,0 2.362	14,0 0.551	140°	TiAIN	IT9
SD1103A-1275-043-14R1 SD_DRILL_12.75MM_3XD_A	02898369	12,75 0.502	43,0 1.693	107,0 4.213	62,0 2.441	45,0 1.772	60,0 2.362	14,0 0.551	140°	TiAIN	IT9
SD1103A-1280-043-14R1 SD_DRILL_12.8MM_3XD_A	02898370	12,8 0.504	43,0 1.693	107,0 4.213	62,0 2.441	45,0 1.772	60,0 2.362	14,0 0.551	140°	TiAIN	IT9
SD1103A-1290-043-14R1 SD_DRILL_12.9MM_3XD_A	02898371	12,9 0.508	43,0 1.693	107,0 4.213	62,0 2.441	45,0 1.772	60,0 2.362	14,0 0.551	140°	TiAIN	IT9
SD1103A-1300-043-14R1 SD_DRILL_13.0MM_3XD_A	02898372	13,0 0.512	43,0 1.693	107,0 4.213	62,0 2.441	45,0 1.772	60,0 2.362	14,0 0.551	140°	TiAIN	IT9
SD1103A-1310-043-14R1 SD_DRILL_33/64_3XD_A	02898373	13,1 0.516	43,0 1.693	107,0 4.213	62,0 2.441	45,0 1.772	60,0 2.362	14,0 0.551	140°	TiAIN	IT9
SD1103A-1320-043-14R1 SD_DRILL_13.2MM_3XD_A	02898374	13,2 0.520	43,0 1.693	107,0 4.213	62,0 2.441	45,0 1.772	60,0 2.362	14,0 0.551	140°	TiAIN	IT9
SD1103A-1330-043-14R1 SD_DRILL_13.3MM_3XD_A	02898375	13,3 0.524	43,0 1.693	107,0 4.213	62,0 2.441	45,0 1.772	60,0 2.362	14,0 0.551	140°	TiAIN	IT9
SD1103A-1340-043-14R1 SD_DRILL_13.4MM_3XD_A	02898376	13,4 0.528	43,0 1.693	107,0 4.213	62,0 2.441	45,0 1.772	60,0 2.362	14,0 0.551	140°	TiAIN	IT9
SD1103A-1349-043-14R1 SD_DRILL_17/32_3XD_A	02898377	13,494 0.531	43,0 1.693	107,0 4.213	62,0 2.441	45,0 1.772	60,0 2.362	14,0 0.551	140°	TiAIN	IT9
SD1103A-1350-043-14R1 SD_DRILL_13.5MM_3XD_A	02898378	13,5 0.531	43,0 1.693	107,0 4.213	62,0 2.441	45,0 1.772	60,0 2.362	14,0 0.551	140°	TiAIN	IT9
SD1103A-1360-043-14R1 SD_DRILL_13.6MM_3XD_A	02898379	13,6 0.535	43,0 1.693	107,0 4.213	62,0 2.441	45,0 1.772	60,0 2.362	14,0 0.551	140°	TiAIN	IT9
SD1103A-1370-043-14R1 SD_DRILL_13.7MM_3XD_A	02898380	13,7 0.539	43,0 1.693	107,0 4.213	62,0 2.441	45,0 1.772	60,0 2.362	14,0 0.551	140°	TiAIN	IT9
SD1103A-1380-043-14R1 SD_DRILL_13.8MM_3XD_A	02898381	13,8 0.543	43,0 1.693	107,0 4.213	62,0 2.441	45,0 1.772	60,0 2.362	14,0 0.551	140°	TiAIN	IT9
SD1103A-1390-043-14R1 SD_DRILL_13.9MM_3XD_A	02898382	13,9 0.547	43,0 1.693	107,0 4.213	62,0 2.441	45,0 1.772	60,0 2.362	14,0 0.551	140°	TiAIN	IT9
SD1103A-1400-043-14R1 SD_DRILL_14.0MM_3XD_A	02898383	14,0 0.551	43,0 1.693	107,0 4.213	62,0 2.441	45,0 1.772	60,0 2.362	14,0 0.551	140°	TiAIN	IT9
SD1103A-1420-045-16R1 SD_DRILL_14.2MM_3XD_A	02898384	14,2 0.559	45,0 1.772	115,0 4.528	67,0 2.638	48,0 1.890	65,0 2.559	16,0 0.630	140°	TiAIN	IT9
SD1103A-1429-045-16R1 SD_DRILL_9/16_3XD_A	02898385	14,288 0.563	45,0 1.772	115,0 4.528	67,0 2.638	48,0 1.890	65,0 2.559	16,0 0.630	140°	TiAIN	IT9
SD1103A-1450-045-16R1 SD_DRILL_14.5MM_3XD_A	02898386	14,5 0.571	45,0 1.772	115,0 4.528	67,0 2.638	48,0 1.890	65,0 2.559	16,0 0.630	140°	TiAIN	IT9
SD1103A-1470-045-16R1 SD_DRILL_14.7MM_3XD_A	02898387	14,7 0.579	45,0 1.772	115,0 4.528	67,0 2.638	48,0 1.890	65,0 2.559	16,0 0.630	140°	TiAIN	IT9
SD1103A-1475-045-16R1 SD_DRILL_14.75MM_3XD_A	02898388	14,75 0.581	45,0 1.772	115,0 4.528	67,0 2.638	48,0 1.890	65,0 2.559	16,0 0.630	140°	TiAIN	IT9
SD1103A-1480-045-16R1 SD_DRILL_14.8MM_3XD_A	02898389	14,8 0.583	45,0 1.772	115,0 4.528	67,0 2.638	48,0 1.890	65,0 2.559	16,0 0.630	140°	TiAIN	IT9

Introduzione

Foratura

Alesatura

Barenatura

Allegato

Codice di ordinazione	Codice prodotto	DC	LU	OAL	LFS	LS	LCF	DMM	Angolo di punta	Rivestimento	Tolleranza foro
		mm Inch	mm Inch	mm Inch	mm Inch	mm Inch	mm Inch	mm Inch			
SD1103A-1500-045-16R1 SD_DRILL_15.0MM_3XD_A	02898390	15,0 0.591	45,0 1.772	115,0 4.528	67,0 2.638	48,0 1.890	65,0 2.559	16,0 0.630	140°	TiAIN	IT9
SD1103A-1510-045-16R1 SD_DRILL_15.1MM_3XD_A	02898391	15,1 0.594	45,0 1.772	115,0 4.528	67,0 2.638	48,0 1.890	65,0 2.559	16,0 0.630	140°	TiAIN	IT9
SD1103A-1530-045-16R1 SD_DRILL_15.3MM_3XD_A	02898392	15,3 0.602	45,0 1.772	115,0 4.528	67,0 2.638	48,0 1.890	65,0 2.559	16,0 0.630	140°	TiAIN	IT9
SD1103A-1550-045-16R1 SD_DRILL_15.5MM_3XD_A	02898393	15,5 0.610	45,0 1.772	115,0 4.528	67,0 2.638	48,0 1.890	65,0 2.559	16,0 0.630	140°	TiAIN	IT9
SD1103A-1570-045-16R1 SD_DRILL_15.7MM_3XD_A	02898394	15,7 0.618	45,0 1.772	115,0 4.528	67,0 2.638	48,0 1.890	65,0 2.559	16,0 0.630	140°	TiAIN	IT9
SD1103A-1580-045-16R1 SD_DRILL_15.8MM_3XD_A	02898395	15,8 0.622	45,0 1.772	115,0 4.528	67,0 2.638	48,0 1.890	65,0 2.559	16,0 0.630	140°	TiAIN	IT9
SD1103A-1588-045-16R1 SD_DRILL_5/8_3XD_A	02898396	15,875 0.625	45,0 1.772	115,0 4.528	67,0 2.638	48,0 1.890	65,0 2.559	16,0 0.630	140°	TiAIN	IT9
SD1103A-1600-045-16R1 SD_DRILL_16.0MM_3XD_A	02898397	16,0 0.630	45,0 1.772	115,0 4.528	67,0 2.638	48,0 1.890	65,0 2.559	16,0 0.630	140°	TiAIN	IT9
SD1103A-1650-051-18R1 SD_DRILL_16.5MM_3XD_A	02898398	16,5 0.650	51,0 2.008	123,0 4.843	75,0 2.953	48,0 1.890	73,0 2.874	18,0 0.709	140°	TiAIN	IT9
SD1103A-1700-051-18R1 SD_DRILL_17.0MM_3XD_A	02898399	17,0 0.669	51,0 2.008	123,0 4.843	75,0 2.953	48,0 1.890	73,0 2.874	18,0 0.709	140°	TiAIN	IT9
SD1103A-1750-051-18R1 SD_DRILL_17.5MM_3XD_A	02898400	17,5 0.689	51,0 2.008	123,0 4.843	75,0 2.953	48,0 1.890	73,0 2.874	18,0 0.709	140°	TiAIN	IT9
SD1103A-1800-051-18R1 SD_DRILL_18.0MM_3XD_A	02898401	18,0 0.709	51,0 2.008	123,0 4.843	75,0 2.953	48,0 1.890	73,0 2.874	18,0 0.709	140°	TiAIN	IT9
SD1103A-1850-055-20R1 SD_DRILL_18.5MM_3XD_A	02898402	18,5 0.728	55,0 2.165	131,0 5.157	81,0 3.189	50,0 1.969	79,0 3.110	20,0 0.787	140°	TiAIN	IT9
SD1103A-1900-055-20R1 SD_DRILL_19.0MM_3XD_A	02898403	19,0 0.748	55,0 2.165	131,0 5.157	81,0 3.189	50,0 1.969	79,0 3.110	20,0 0.787	140°	TiAIN	IT9
SD1103A-1905-055-20R1 SD_DRILL_3/4_3XD_A	02898404	19,05 0.750	55,0 2.165	131,0 5.157	81,0 3.189	50,0 1.969	79,0 3.110	20,0 0.787	140°	TiAIN	IT9
SD1103A-1950-055-20R1 SD_DRILL_19.5MM_3XD_A	02898405	19,5 0.768	55,0 2.165	131,0 5.157	81,0 3.189	50,0 1.969	79,0 3.110	20,0 0.787	140°	TiAIN	IT9
SD1103A-2000-055-20R1 SD_DRILL_20.0MM_3XD_A	02898406	20,0 0.787	55,0 2.165	131,0 5.157	81,0 3.189	50,0 1.969	79,0 3.110	20,0 0.787	140°	TiAIN	IT9

Introduzione

Foratura

Alesatura

Barenatura

Allegato

SD1105A

Profondità di foratura ~ 5 x D – Misure metriche/Pollici

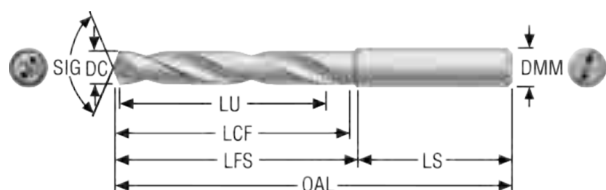

- Codolo cilindrico DIN 6537A
- Adduzione refrigerante interna
- Per i parametri di taglio raccomandati, vedere pagina(e) 142
- Per i diametri intermedi, utilizzare MyDesign.

Codice di ordinazione	Codice prodotto	DC	LU	OAL	LFS	LS	LCF	DMM	Angolo di punta	Rivestimento	Tolleranza foro
		mm Inch	mm Inch	mm Inch	mm Inch	mm Inch	mm Inch	mm Inch			
SD1105A-0300-023-06R1 SD_DRILL_3.0MM_5XD_A	02897845	3,0 0.118	23,0 0.906	66,0 2.598	30,0 1.181	36,0 1.417	28,0 1.102	6,0 0.236	140°	TiAlN	IT9
SD1105A-0310-023-06R1 SD_DRILL_3.1MM_5XD_A	02897846	3,1 0.122	23,0 0.906	66,0 2.598	30,0 1.181	36,0 1.417	28,0 1.102	6,0 0.236	140°	TiAlN	IT9
SD1105A-0318-023-06R1 SD_DRILL_1/8_5XD_A	02897847	3,175 0.125	23,0 0.906	66,0 2.598	30,0 1.181	36,0 1.417	28,0 1.102	6,0 0.236	140°	TiAlN	IT9
SD1105A-0320-023-06R1 SD_DRILL_3.2MM_5XD_A	02897848	3,2 0.126	23,0 0.906	66,0 2.598	30,0 1.181	36,0 1.417	28,0 1.102	6,0 0.236	140°	TiAlN	IT9
SD1105A-0325-023-06R1 SD_DRILL_3.25MM_5XD_A	02897849	3,25 0.128	23,0 0.906	66,0 2.598	30,0 1.181	36,0 1.417	28,0 1.102	6,0 0.236	140°	TiAlN	IT9
SD1105A-0330-023-06R1 SD_DRILL_3.3MM_5XD_A	02897850	3,3 0.130	23,0 0.906	66,0 2.598	30,0 1.181	36,0 1.417	28,0 1.102	6,0 0.236	140°	TiAlN	IT9
SD1105A-0340-023-06R1 SD_DRILL_3.4MM_5XD_A	02897851	3,4 0.134	23,0 0.906	66,0 2.598	30,0 1.181	36,0 1.417	28,0 1.102	6,0 0.236	140°	TiAlN	IT9
SD1105A-0350-023-06R1 SD_DRILL_3.5MM_5XD_A	02897852	3,5 0.138	23,0 0.906	66,0 2.598	30,0 1.181	36,0 1.417	28,0 1.102	6,0 0.236	140°	TiAlN	IT9
SD1105A-0357-023-06R1 SD_DRILL_9/64_5XD_A	02897853	3,572 0.141	23,0 0.906	66,0 2.598	30,0 1.181	36,0 1.417	28,0 1.102	6,0 0.236	140°	TiAlN	IT9
SD1105A-0360-023-06R1 SD_DRILL_3.6MM_5XD_A	02897854	3,6 0.142	23,0 0.906	66,0 2.598	30,0 1.181	36,0 1.417	28,0 1.102	6,0 0.236	140°	TiAlN	IT9
SD1105A-0365-023-06R1 SD_DRILL_3.65MM_5XD_A	02897855	3,65 0.144	23,0 0.906	66,0 2.598	30,0 1.181	36,0 1.417	28,0 1.102	6,0 0.236	140°	TiAlN	IT9
SD1105A-0370-023-06R1 SD_DRILL_3.7MM_5XD_A	02897856	3,7 0.146	23,0 0.906	66,0 2.598	30,0 1.181	36,0 1.417	28,0 1.102	6,0 0.236	140°	TiAlN	IT9
SD1105A-0380-029-06R1 SD_DRILL_3.8MM_5XD_A	02897857	3,8 0.150	29,0 1.142	74,0 2.913	38,0 1.496	36,0 1.417	36,0 1.417	6,0 0.236	140°	TiAlN	IT9
SD1105A-0390-029-06R1 SD_DRILL_3.9MM_5XD_A	02897858	3,9 0.154	29,0 1.142	74,0 2.913	38,0 1.496	36,0 1.417	36,0 1.417	6,0 0.236	140°	TiAlN	IT9
SD1105A-0397-029-06R1 SD_DRILL_5/32_5XD_A	02897859	3,969 0.156	29,0 1.142	74,0 2.913	38,0 1.496	36,0 1.417	36,0 1.417	6,0 0.236	140°	TiAlN	IT9
SD1105A-0400-029-06R1 SD_DRILL_4.0MM_5XD_A	02897860	4,0 0.157	29,0 1.142	74,0 2.913	38,0 1.496	36,0 1.417	36,0 1.417	6,0 0.236	140°	TiAlN	IT9
SD1105A-0410-029-06R1 SD_DRILL_4.1MM_5XD_A	02897861	4,1 0.161	29,0 1.142	74,0 2.913	38,0 1.496	36,0 1.417	36,0 1.417	6,0 0.236	140°	TiAlN	IT9
SD1105A-0420-029-06R1 SD_DRILL_4.2MM_5XD_A	02897862	4,2 0.165	29,0 1.142	74,0 2.913	38,0 1.496	36,0 1.417	36,0 1.417	6,0 0.236	140°	TiAlN	IT9
SD1105A-0430-029-06R1 SD_DRILL_4.3MM_5XD_A	02897863	4,3 0.169	29,0 1.142	74,0 2.913	38,0 1.496	36,0 1.417	36,0 1.417	6,0 0.236	140°	TiAlN	IT9
SD1105A-0437-029-06R1 SD_DRILL_11/64_5XD_A	02897864	4,366 0.172	29,0 1.142	74,0 2.913	38,0 1.496	36,0 1.417	36,0 1.417	6,0 0.236	140°	TiAlN	IT9
SD1105A-0440-029-06R1 SD_DRILL_4.4MM_5XD_A	02897865	4,4 0.173	29,0 1.142	74,0 2.913	38,0 1.496	36,0 1.417	36,0 1.417	6,0 0.236	140°	TiAlN	IT9
SD1105A-0450-029-06R1 SD_DRILL_4.5MM_5XD_A	02897866	4,5 0.177	29,0 1.142	74,0 2.913	38,0 1.496	36,0 1.417	36,0 1.417	6,0 0.236	140°	TiAlN	IT9

Introduzione

Foratura

Alesatura

Barenatura

Allegato

Codice di ordinazione	Codice prodotto	DC	LU	OAL	LFS	LS	LCF	DMM	Angolo di punta	Rivestimento	Tolleranza foro	
		mm Inch	mm Inch	mm Inch	mm Inch	mm Inch	mm Inch	mm Inch				
Introduzione	SD1105A-0460-029-06R1 SD_DRILL_4.6MM_5XD_A	02897867	4,6 0.181	29,0 1.142	74,0 2.913	38,0 1.496	36,0 1.417	36,0 1.417	6,0 0.236	140°	TiAIN	IT9
	SD1105A-0465-029-06R1 SD_DRILL_4.65MM_5XD_A	02897868	4,65 0.183	29,0 1.142	74,0 2.913	38,0 1.496	36,0 1.417	36,0 1.417	6,0 0.236	140°	TiAIN	IT9
	SD1105A-0470-029-06R1 SD_DRILL_4.7MM_5XD_A	02897869	4,7 0.185	29,0 1.142	74,0 2.913	38,0 1.496	36,0 1.417	36,0 1.417	6,0 0.236	140°	TiAIN	IT9
	SD1105A-0476-035-06R1 SD_DRILL_3/16_5XD_A	02897870	4,763 0.188	35,0 1.378	82,0 3.228	46,0 1.811	36,0 1.417	44,0 1.732	6,0 0.236	140°	TiAIN	IT9
Foratura	SD1105A-0480-035-06R1 SD_DRILL_4.8MM_5XD_A	02897871	4,8 0.189	35,0 1.378	82,0 3.228	46,0 1.811	36,0 1.417	44,0 1.732	6,0 0.236	140°	TiAIN	IT9
	SD1105A-0490-035-06R1 SD_DRILL_4.9MM_5XD_A	02897872	4,9 0.193	35,0 1.378	82,0 3.228	46,0 1.811	36,0 1.417	44,0 1.732	6,0 0.236	140°	TiAIN	IT9
	SD1105A-0500-035-06R1 SD_DRILL_5.0MM_5XD_A	02897873	5,0 0.197	35,0 1.378	82,0 3.228	46,0 1.811	36,0 1.417	44,0 1.732	6,0 0.236	140°	TiAIN	IT9
	SD1105A-0510-035-06R1 SD_DRILL_5.1MM_5XD_A	02897874	5,1 0.201	35,0 1.378	82,0 3.228	46,0 1.811	36,0 1.417	44,0 1.732	6,0 0.236	140°	TiAIN	IT9
	SD1105A-0516-035-06R1 SD_DRILL_13/64_5XD_A	02897875	5,159 0.203	35,0 1.378	82,0 3.228	46,0 1.811	36,0 1.417	44,0 1.732	6,0 0.236	140°	TiAIN	IT9
	SD1105A-0520-035-06R1 SD_DRILL_5.2MM_5XD_A	02897876	5,2 0.205	35,0 1.378	82,0 3.228	46,0 1.811	36,0 1.417	44,0 1.732	6,0 0.236	140°	TiAIN	IT9
	SD1105A-0530-035-06R1 SD_DRILL_5.3MM_5XD_A	02897877	5,3 0.209	35,0 1.378	82,0 3.228	46,0 1.811	36,0 1.417	44,0 1.732	6,0 0.236	140°	TiAIN	IT9
	SD1105A-0540-035-06R1 SD_DRILL_5.4MM_5XD_A	02897878	5,4 0.213	35,0 1.378	82,0 3.228	46,0 1.811	36,0 1.417	44,0 1.732	6,0 0.236	140°	TiAIN	IT9
	SD1105A-0550-035-06R1 SD_DRILL_5.5MM_5XD_A	02897879	5,5 0.217	35,0 1.378	82,0 3.228	46,0 1.811	36,0 1.417	44,0 1.732	6,0 0.236	140°	TiAIN	IT9
	SD1105A-0555-035-06R1 SD_DRILL_5.55MM_5XD_A	02897880	5,55 0.219	35,0 1.378	82,0 3.228	46,0 1.811	36,0 1.417	44,0 1.732	6,0 0.236	140°	TiAIN	IT9
	SD1105A-0556-035-06R1 SD_DRILL_7/32_5XD_A	02897881	5,556 0.219	35,0 1.378	82,0 3.228	46,0 1.811	36,0 1.417	44,0 1.732	6,0 0.236	140°	TiAIN	IT9
	SD1105A-0560-035-06R1 SD_DRILL_5.6MM_5XD_A	02897882	5,6 0.220	35,0 1.378	82,0 3.228	46,0 1.811	36,0 1.417	44,0 1.732	6,0 0.236	140°	TiAIN	IT9
	SD1105A-0570-035-06R1 SD_DRILL_5.7MM_5XD_A	02897883	5,7 0.224	35,0 1.378	82,0 3.228	46,0 1.811	36,0 1.417	44,0 1.732	6,0 0.236	140°	TiAIN	IT9
	SD1105A-0580-035-06R1 SD_DRILL_5.8MM_5XD_A	02897884	5,8 0.228	35,0 1.378	82,0 3.228	46,0 1.811	36,0 1.417	44,0 1.732	6,0 0.236	140°	TiAIN	IT9
	SD1105A-0590-035-06R1 SD_DRILL_5.9MM_5XD_A	02897885	5,9 0.232	35,0 1.378	82,0 3.228	46,0 1.811	36,0 1.417	44,0 1.732	6,0 0.236	140°	TiAIN	IT9
	SD1105A-0595-035-06R1 SD_DRILL_15/64_5XD_A	02897886	5,953 0.234	35,0 1.378	82,0 3.228	46,0 1.811	36,0 1.417	44,0 1.732	6,0 0.236	140°	TiAIN	IT9
Barenatura	SD1105A-0600-035-06R1 SD_DRILL_6.0MM_5XD_A	02897887	6,0 0.236	35,0 1.378	82,0 3.228	46,0 1.811	36,0 1.417	44,0 1.732	6,0 0.236	140°	TiAIN	IT9
	SD1105A-0610-043-08R1 SD_DRILL_6.1MM_5XD_A	02897888	6,1 0.240	43,0 1.693	91,0 3.583	55,0 2.165	36,0 1.417	53,0 2.087	8,0 0.315	140°	TiAIN	IT9
	SD1105A-0620-043-08R1 SD_DRILL_6.2MM_5XD_A	02897889	6,2 0.244	43,0 1.693	91,0 3.583	55,0 2.165	36,0 1.417	53,0 2.087	8,0 0.315	140°	TiAIN	IT9
	SD1105A-0630-043-08R1 SD_DRILL_6.3MM_5XD_A	02897890	6,3 0.248	43,0 1.693	91,0 3.583	55,0 2.165	36,0 1.417	53,0 2.087	8,0 0.315	140°	TiAIN	IT9
	SD1105A-0635-043-08R1 SD_DRILL_1/4_5XD_A	02897891	6,35 0.250	43,0 1.693	91,0 3.583	55,0 2.165	36,0 1.417	53,0 2.087	8,0 0.315	140°	TiAIN	IT9
	SD1105A-0640-043-08R1 SD_DRILL_6.4MM_5XD_A	02897892	6,4 0.252	43,0 1.693	91,0 3.583	55,0 2.165	36,0 1.417	53,0 2.087	8,0 0.315	140°	TiAIN	IT9
	SD1105A-0650-043-08R1 SD_DRILL_6.5MM_5XD_A	02897893	6,5 0.256	43,0 1.693	91,0 3.583	55,0 2.165	36,0 1.417	53,0 2.087	8,0 0.315	140°	TiAIN	IT9
	SD1105A-0660-043-08R1 SD_DRILL_6.6MM_5XD_A	02897894	6,6 0.260	43,0 1.693	91,0 3.583	55,0 2.165	36,0 1.417	53,0 2.087	8,0 0.315	140°	TiAIN	IT9
	SD1105A-0670-043-08R1 SD_DRILL_6.7MM_5XD_A	02897895	6,7 0.264	43,0 1.693	91,0 3.583	55,0 2.165	36,0 1.417	53,0 2.087	8,0 0.315	140°	TiAIN	IT9
	SD1105A-0675-043-08R1 SD_DRILL_17/64_5XD_A	02897896	6,747 0.266	43,0 1.693	91,0 3.583	55,0 2.165	36,0 1.417	53,0 2.087	8,0 0.315	140°	TiAIN	IT9
Allegato	SD1105A-0680-043-08R1 SD_DRILL_6.8MM_5XD_A	02897897	6,8 0.268	43,0 1.693	91,0 3.583	55,0 2.165	36,0 1.417	53,0 2.087	8,0 0.315	140°	TiAIN	IT9

Codice di ordinazione	Codice prodotto	DC	LU	OAL	LFS	LS	LCF	DMM	Angolo di punta	Rivestimento	Tolleranza foro
		mm <i>Inch</i>	mm <i>Inch</i>	mm <i>Inch</i>	mm <i>Inch</i>	mm <i>Inch</i>	mm <i>Inch</i>	mm <i>Inch</i>			
SD1105A-0690-043-08R1 SD_DRILL_6.9MM_5XD_A	02897898	6,9 0.272	43,0 1.693	91,0 3.583	55,0 2.165	36,0 1.417	53,0 2.087	8,0 0.315	140°	TiAIN	IT9
SD1105A-0700-043-08R1 SD_DRILL_7.0MM_5XD_A	02897899	7,0 0.276	43,0 1.693	91,0 3.583	55,0 2.165	36,0 1.417	53,0 2.087	8,0 0.315	140°	TiAIN	IT9
SD1105A-0710-043-08R1 SD_DRILL_7.1MM_5XD_A	02897900	7,1 0.280	43,0 1.693	91,0 3.583	55,0 2.165	36,0 1.417	53,0 2.087	8,0 0.315	140°	TiAIN	IT9
SD1105A-0714-043-08R1 SD_DRILL_9/32_5XD_A	02897901	7,144 0.281	43,0 1.693	91,0 3.583	55,0 2.165	36,0 1.417	53,0 2.087	8,0 0.315	140°	TiAIN	IT9
SD1105A-0720-043-08R1 SD_DRILL_7.2MM_5XD_A	02897902	7,2 0.283	43,0 1.693	91,0 3.583	55,0 2.165	36,0 1.417	53,0 2.087	8,0 0.315	140°	TiAIN	IT9
SD1105A-0730-043-08R1 SD_DRILL_7.3MM_5XD_A	02897903	7,3 0.287	43,0 1.693	91,0 3.583	55,0 2.165	36,0 1.417	53,0 2.087	8,0 0.315	140°	TiAIN	IT9
SD1105A-0740-043-08R1 SD_DRILL_7.4MM_5XD_A	02897904	7,4 0.291	43,0 1.693	91,0 3.583	55,0 2.165	36,0 1.417	53,0 2.087	8,0 0.315	140°	TiAIN	IT9
SD1105A-0750-043-08R1 SD_DRILL_7.5MM_5XD_A	02897905	7,5 0.295	43,0 1.693	91,0 3.583	55,0 2.165	36,0 1.417	53,0 2.087	8,0 0.315	140°	TiAIN	IT9
SD1105A-0754-043-08R1 SD_DRILL_19/64_5XD_A	02897906	7,541 0.297	43,0 1.693	91,0 3.583	55,0 2.165	36,0 1.417	53,0 2.087	8,0 0.315	140°	TiAIN	IT9
SD1105A-0755-043-08R1 SD_DRILL_7.55MM_5XD_A	02897907	7,55 0.297	43,0 1.693	91,0 3.583	55,0 2.165	36,0 1.417	53,0 2.087	8,0 0.315	140°	TiAIN	IT9
SD1105A-0760-043-08R1 SD_DRILL_7.6MM_5XD_A	02897908	7,6 0.299	43,0 1.693	91,0 3.583	55,0 2.165	36,0 1.417	53,0 2.087	8,0 0.315	140°	TiAIN	IT9
SD1105A-0770-043-08R1 SD_DRILL_7.7MM_5XD_A	02897909	7,7 0.303	43,0 1.693	91,0 3.583	55,0 2.165	36,0 1.417	53,0 2.087	8,0 0.315	140°	TiAIN	IT9
SD1105A-0780-043-08R1 SD_DRILL_7.8MM_5XD_A	02897910	7,8 0.307	43,0 1.693	91,0 3.583	55,0 2.165	36,0 1.417	53,0 2.087	8,0 0.315	140°	TiAIN	IT9
SD1105A-0790-043-08R1 SD_DRILL_7.9MM_5XD_A	02897911	7,9 0.311	43,0 1.693	91,0 3.583	55,0 2.165	36,0 1.417	53,0 2.087	8,0 0.315	140°	TiAIN	IT9
SD1105A-0794-043-08R1 SD_DRILL_5/16_5XD_A	02897912	7,938 0.313	43,0 1.693	91,0 3.583	55,0 2.165	36,0 1.417	53,0 2.087	8,0 0.315	140°	TiAIN	IT9
SD1105A-0800-043-08R1 SD_DRILL_8.0MM_5XD_A	02897913	8,0 0.315	43,0 1.693	91,0 3.583	55,0 2.165	36,0 1.417	53,0 2.087	8,0 0.315	140°	TiAIN	IT9
SD1105A-0810-049-10R1 SD_DRILL_8.1MM_5XD_A	02897914	8,1 0.319	49,0 1.929	103,0 4.055	63,0 2.480	40,0 1.575	61,0 2.402	10,0 0.394	140°	TiAIN	IT9
SD1105A-0820-049-10R1 SD_DRILL_8.2MM_5XD_A	02897915	8,2 0.323	49,0 1.929	103,0 4.055	63,0 2.480	40,0 1.575	61,0 2.402	10,0 0.394	140°	TiAIN	IT9
SD1105A-0830-049-10R1 SD_DRILL_8.3MM_5XD_A	02897916	8,3 0.327	49,0 1.929	103,0 4.055	63,0 2.480	40,0 1.575	61,0 2.402	10,0 0.394	140°	TiAIN	IT9
SD1105A-0833-049-10R1 SD_DRILL_21/64_5XD_A	02897917	8,334 0.328	49,0 1.929	103,0 4.055	63,0 2.480	40,0 1.575	61,0 2.402	10,0 0.394	140°	TiAIN	IT9
SD1105A-0840-049-10R1 SD_DRILL_8.4MM_5XD_A	02897918	8,4 0.331	49,0 1.929	103,0 4.055	63,0 2.480	40,0 1.575	61,0 2.402	10,0 0.394	140°	TiAIN	IT9
SD1105A-0850-049-10R1 SD_DRILL_8.5MM_5XD_A	02897919	8,5 0.335	49,0 1.929	103,0 4.055	63,0 2.480	40,0 1.575	61,0 2.402	10,0 0.394	140°	TiAIN	IT9
SD1105A-0860-049-10R1 SD_DRILL_8.6MM_5XD_A	02897920	8,6 0.339	49,0 1.929	103,0 4.055	63,0 2.480	40,0 1.575	61,0 2.402	10,0 0.394	140°	TiAIN	IT9
SD1105A-0870-049-10R1 SD_DRILL_8.7MM_5XD_A	02897921	8,7 0.343	49,0 1.929	103,0 4.055	63,0 2.480	40,0 1.575	61,0 2.402	10,0 0.394	140°	TiAIN	IT9
SD1105A-0873-049-10R1 SD_DRILL_11/32_5XD_A	02897922	8,731 0.344	49,0 1.929	103,0 4.055	63,0 2.480	40,0 1.575	61,0 2.402	10,0 0.394	140°	TiAIN	IT9
SD1105A-0880-049-10R1 SD_DRILL_8.8MM_5XD_A	02897923	8,8 0.346	49,0 1.929	103,0 4.055	63,0 2.480	40,0 1.575	61,0 2.402	10,0 0.394	140°	TiAIN	IT9
SD1105A-0890-049-10R1 SD_DRILL_8.9MM_5XD_A	02897924	8,9 0.350	49,0 1.929	103,0 4.055	63,0 2.480	40,0 1.575	61,0 2.402	10,0 0.394	140°	TiAIN	IT9
SD1105A-0900-049-10R1 SD_DRILL_9.0MM_5XD_A	02897925	9,0 0.354	49,0 1.929	103,0 4.055	63,0 2.480	40,0 1.575	61,0 2.402	10,0 0.394	140°	TiAIN	IT9
SD1105A-0910-049-10R1 SD_DRILL_9.1MM_5XD_A	02897926	9,1 0.358	49,0 1.929	103,0 4.055	63,0 2.480	40,0 1.575	61,0 2.402	10,0 0.394	140°	TiAIN	IT9
SD1105A-0913-049-10R1 SD_DRILL_23/64_5XD_A	02897927	9,128 0.359	49,0 1.929	103,0 4.055	63,0 2.480	40,0 1.575	61,0 2.402	10,0 0.394	140°	TiAIN	IT9
SD1105A-0920-049-10R1 SD_DRILL_9.2MM_5XD_A	02897928	9,2 0.362	49,0 1.929	103,0 4.055	63,0 2.480	40,0 1.575	61,0 2.402	10,0 0.394	140°	TiAIN	IT9

Introduzione

Foratura

Alesatura

Barenatura

Allegato

	Codice di ordinazione	Codice prodotto	DC	LU	OAL	LFS	LS	LCF	DMM	Angolo di punta	Rivestimento	Tolleranza foro	
			mm Inch	mm Inch	mm Inch	mm Inch	mm Inch	mm Inch	mm Inch				
Introduzione	SD1105A-0930-049-10R1 SD_DRILL_9.3MM_5XD_A	02897929	9,3 0.366	49,0 1.929	103,0 4.055	63,0 2.480	40,0 1.575	61,0 2.402	10,0 0.394	140°	TiAIN	IT9	
	SD1105A-0940-049-10R1 SD_DRILL_9.4MM_5XD_A	02897930	9,4 0.370	49,0 1.929	103,0 4.055	63,0 2.480	40,0 1.575	61,0 2.402	10,0 0.394	140°	TiAIN	IT9	
	SD1105A-0950-049-10R1 SD_DRILL_9.5MM_5XD_A	02897931	9,5 0.374	49,0 1.929	103,0 4.055	63,0 2.480	40,0 1.575	61,0 2.402	10,0 0.394	140°	TiAIN	IT9	
	SD1105A-0953-049-10R1 SD_DRILL_3/8_5XD_A	02897932	9,525 0.375	49,0 1.929	103,0 4.055	63,0 2.480	40,0 1.575	61,0 2.402	10,0 0.394	140°	TiAIN	IT9	
	SD1105A-0955-049-10R1 SD_DRILL_9.55MM_5XD_A	02897933	9,55 0.376	49,0 1.929	103,0 4.055	63,0 2.480	40,0 1.575	61,0 2.402	10,0 0.394	140°	TiAIN	IT9	
Foratura	SD1105A-0960-049-10R1 SD_DRILL_9.6MM_5XD_A	02897934	9,6 0.378	49,0 1.929	103,0 4.055	63,0 2.480	40,0 1.575	61,0 2.402	10,0 0.394	140°	TiAIN	IT9	
	SD1105A-0970-049-10R1 SD_DRILL_9.7MM_5XD_A	02897935	9,7 0.382	49,0 1.929	103,0 4.055	63,0 2.480	40,0 1.575	61,0 2.402	10,0 0.394	140°	TiAIN	IT9	
	SD1105A-0980-049-10R1 SD_DRILL_9.8MM_5XD_A	02897936	9,8 0.386	49,0 1.929	103,0 4.055	63,0 2.480	40,0 1.575	61,0 2.402	10,0 0.394	140°	TiAIN	IT9	
	SD1105A-0990-049-10R1 SD_DRILL_9.9MM_5XD_A	02897937	9,9 0.390	49,0 1.929	103,0 4.055	63,0 2.480	40,0 1.575	61,0 2.402	10,0 0.394	140°	TiAIN	IT9	
	SD1105A-0992-049-10R1 SD_DRILL_25/64_5XD_A	02897938	9,922 0.391	49,0 1.929	103,0 4.055	63,0 2.480	40,0 1.575	61,0 2.402	10,0 0.394	140°	TiAIN	IT9	
	SD1105A-1000-049-10R1 SD_DRILL_10.0MM_5XD_A	02897939	10,0 0.394	49,0 1.929	103,0 4.055	63,0 2.480	40,0 1.575	61,0 2.402	10,0 0.394	140°	TiAIN	IT9	
	SD1105A-1010-056-12R1 SD_DRILL_10.1MM_5XD_A	02897940	10,1 0.398	56,0 2.205	118,0 4.646	73,0 2.874	45,0 1.772	71,0 2.795	12,0 0.472	140°	TiAIN	IT9	
	SD1105A-1020-056-12R1 SD_DRILL_10.2MM_5XD_A	02897941	10,2 0.402	56,0 2.205	118,0 4.646	73,0 2.874	45,0 1.772	71,0 2.795	12,0 0.472	140°	TiAIN	IT9	
	SD1105A-1030-056-12R1 SD_DRILL_10.3MM_5XD_A	02897942	10,3 0.406	56,0 2.205	118,0 4.646	73,0 2.874	45,0 1.772	71,0 2.795	12,0 0.472	140°	TiAIN	IT9	
	SD1105A-1032-056-12R1 SD_DRILL_13/32_5XD_A	02897943	10,319 0.406	56,0 2.205	118,0 4.646	73,0 2.874	45,0 1.772	71,0 2.795	12,0 0.472	140°	TiAIN	IT9	
Alesatura	SD1105A-1040-056-12R1 SD_DRILL_10.4MM_5XD_A	02897944	10,4 0.409	56,0 2.205	118,0 4.646	73,0 2.874	45,0 1.772	71,0 2.795	12,0 0.472	140°	TiAIN	IT9	
	SD1105A-1050-056-12R1 SD_DRILL_10.5MM_5XD_A	02897945	10,5 0.413	56,0 2.205	118,0 4.646	73,0 2.874	45,0 1.772	71,0 2.795	12,0 0.472	140°	TiAIN	IT9	
	SD1105A-1060-056-12R1 SD_DRILL_10.6MM_5XD_A	02897946	10,6 0.417	56,0 2.205	118,0 4.646	73,0 2.874	45,0 1.772	71,0 2.795	12,0 0.472	140°	TiAIN	IT9	
	SD1105A-1070-056-12R1 SD_DRILL_10.7MM_5XD_A	02897947	10,7 0.421	56,0 2.205	118,0 4.646	73,0 2.874	45,0 1.772	71,0 2.795	12,0 0.472	140°	TiAIN	IT9	
	SD1105A-1072-056-12R1 SD_DRILL_27/64_5XD_A	02897948	10,716 0.422	56,0 2.205	118,0 4.646	73,0 2.874	45,0 1.772	71,0 2.795	12,0 0.472	140°	TiAIN	IT9	
	SD1105A-1080-056-12R1 SD_DRILL_10.8MM_5XD_A	02897949	10,8 0.425	56,0 2.205	118,0 4.646	73,0 2.874	45,0 1.772	71,0 2.795	12,0 0.472	140°	TiAIN	IT9	
	SD1105A-1090-056-12R1 SD_DRILL_10.9MM_5XD_A	02897951	10,9 0.429	56,0 2.205	118,0 4.646	73,0 2.874	45,0 1.772	71,0 2.795	12,0 0.472	140°	TiAIN	IT9	
	SD1105A-1100-056-12R1 SD_DRILL_11.0MM_5XD_A	02897952	11,0 0.433	56,0 2.205	118,0 4.646	73,0 2.874	45,0 1.772	71,0 2.795	12,0 0.472	140°	TiAIN	IT9	
	SD1105A-1110-056-12R1 SD_DRILL_11.1MM_5XD_A	02897953	11,1 0.437	56,0 2.205	118,0 4.646	73,0 2.874	45,0 1.772	71,0 2.795	12,0 0.472	140°	TiAIN	IT9	
	SD1105A-1111-056-12R1 SD_DRILL_7/16_5XD_A	02897954	11,113 0.438	56,0 2.205	118,0 4.646	73,0 2.874	45,0 1.772	71,0 2.795	12,0 0.472	140°	TiAIN	IT9	
Barenatura	SD1105A-1120-056-12R1 SD_DRILL_11.2MM_5XD_A	02897955	11,2 0.441	56,0 2.205	118,0 4.646	73,0 2.874	45,0 1.772	71,0 2.795	12,0 0.472	140°	TiAIN	IT9	
	SD1105A-1130-056-12R1 SD_DRILL_11.3MM_5XD_A	02897956	11,3 0.445	56,0 2.205	118,0 4.646	73,0 2.874	45,0 1.772	71,0 2.795	12,0 0.472	140°	TiAIN	IT9	
	SD1105A-1140-056-12R1 SD_DRILL_11.4MM_5XD_A	02897957	11,4 0.449	56,0 2.205	118,0 4.646	73,0 2.874	45,0 1.772	71,0 2.795	12,0 0.472	140°	TiAIN	IT9	
	SD1105A-1150-056-12R1 SD_DRILL_11.5MM_5XD_A	02897958	11,5 0.453	56,0 2.205	118,0 4.646	73,0 2.874	45,0 1.772	71,0 2.795	12,0 0.472	140°	TiAIN	IT9	
	SD1105A-1151-056-12R1 SD_DRILL_29/64_5XD_A	02897959	11,509 0.453	56,0 2.205	118,0 4.646	73,0 2.874	45,0 1.772	71,0 2.795	12,0 0.472	140°	TiAIN	IT9	
	SD1105A-1155-056-12R1 SD_DRILL_11.55MM_5XD_A	02897960	11,55 0.455	56,0 2.205	118,0 4.646	73,0 2.874	45,0 1.772	71,0 2.795	12,0 0.472	140°	TiAIN	IT9	
	Allegato												

Codice di ordinazione	Codice prodotto	DC	LU	OAL	LFS	LS	LCF	DMM	Angolo di punta	Rivesti-mento	Tolleranza foro
		mm Inch	mm Inch	mm Inch	mm Inch	mm Inch	mm Inch	mm Inch			
SD1105A-1160-056-12R1 SD_DRILL_11.6MM_5XD_A	02897961	11,6 0.457	56,0 2.205	118,0 4.646	73,0 2.874	45,0 1.772	71,0 2.795	12,0 0.472	140°	TiAIN	IT9
SD1105A-1170-056-12R1 SD_DRILL_11.7MM_5XD_A	02897962	11,7 0.461	56,0 2.205	118,0 4.646	73,0 2.874	45,0 1.772	71,0 2.795	12,0 0.472	140°	TiAIN	IT9
SD1105A-1180-056-12R1 SD_DRILL_11.8MM_5XD_A	02897963	11,8 0.465	56,0 2.205	118,0 4.646	73,0 2.874	45,0 1.772	71,0 2.795	12,0 0.472	140°	TiAIN	IT9
SD1105A-1190-056-12R1 SD_DRILL_11.9MM_5XD_A	02897964	11,9 0.469	56,0 2.205	118,0 4.646	73,0 2.874	45,0 1.772	71,0 2.795	12,0 0.472	140°	TiAIN	IT9
SD1105A-1191-056-12R1 SD_DRILL_15/32_5XD_A	02897965	11,906 0.469	56,0 2.205	118,0 4.646	73,0 2.874	45,0 1.772	71,0 2.795	12,0 0.472	140°	TiAIN	IT9
SD1105A-1200-056-12R1 SD_DRILL_12.0MM_5XD_A	02897966	12,0 0.472	56,0 2.205	118,0 4.646	73,0 2.874	45,0 1.772	71,0 2.795	12,0 0.472	140°	TiAIN	IT9
SD1105A-1210-060-14R1 SD_DRILL_12.1MM_5XD_A	02897967	12,1 0.476	60,0 2.362	124,0 4.882	79,0 3.110	45,0 1.772	77,0 3.031	14,0 0.551	140°	TiAIN	IT9
SD1105A-1220-060-14R1 SD_DRILL_12.2MM_5XD_A	02897968	12,2 0.480	60,0 2.362	124,0 4.882	79,0 3.110	45,0 1.772	77,0 3.031	14,0 0.551	140°	TiAIN	IT9
SD1105A-1225-060-14R1 SD_DRILL_12.25MM_5XD_A	02897969	12,25 0.482	60,0 2.362	124,0 4.882	79,0 3.110	45,0 1.772	77,0 3.031	14,0 0.551	140°	TiAIN	IT9
SD1105A-1230-060-14R1 SD_DRILL_31/64_5XD_A	02897970	12,303 0.484	60,0 2.362	124,0 4.882	79,0 3.110	45,0 1.772	77,0 3.031	14,0 0.551	140°	TiAIN	IT9
SD1105A-1240-060-14R1 SD_DRILL_12.4MM_5XD_A	02897972	12,4 0.488	60,0 2.362	124,0 4.882	79,0 3.110	45,0 1.772	77,0 3.031	14,0 0.551	140°	TiAIN	IT9
SD1105A-1250-060-14R1 SD_DRILL_12.5MM_5XD_A	02897973	12,5 0.492	60,0 2.362	124,0 4.882	79,0 3.110	45,0 1.772	77,0 3.031	14,0 0.551	140°	TiAIN	IT9
SD1105A-1260-060-14R1 SD_DRILL_12.6MM_5XD_A	02897974	12,6 0.496	60,0 2.362	124,0 4.882	79,0 3.110	45,0 1.772	77,0 3.031	14,0 0.551	140°	TiAIN	IT9
SD1105A-1270-060-14R1 SD_DRILL_1/2_5XD_A	02897950	12,7 0.500	60,0 2.362	124,0 4.882	79,0 3.110	45,0 1.772	77,0 3.031	14,0 0.551	140°	TiAIN	IT9
SD1105A-1275-060-14R1 SD_DRILL_12.75MM_5XD_A	02897976	12,75 0.502	60,0 2.362	124,0 4.882	79,0 3.110	45,0 1.772	77,0 3.031	14,0 0.551	140°	TiAIN	IT9
SD1105A-1280-060-14R1 SD_DRILL_12.8MM_5XD_A	02897977	12,8 0.504	60,0 2.362	124,0 4.882	79,0 3.110	45,0 1.772	77,0 3.031	14,0 0.551	140°	TiAIN	IT9
SD1105A-1290-060-14R1 SD_DRILL_12.9MM_5XD_A	02897978	12,9 0.508	60,0 2.362	124,0 4.882	79,0 3.110	45,0 1.772	77,0 3.031	14,0 0.551	140°	TiAIN	IT9
SD1105A-1300-060-14R1 SD_DRILL_13.0MM_5XD_A	02897979	13,0 0.512	60,0 2.362	124,0 4.882	79,0 3.110	45,0 1.772	77,0 3.031	14,0 0.551	140°	TiAIN	IT9
SD1105A-1310-060-14R1 SD_DRILL_33/64_5XD_A	02897980	13,1 0.516	60,0 2.362	124,0 4.882	79,0 3.110	45,0 1.772	77,0 3.031	14,0 0.551	140°	TiAIN	IT9
SD1105A-1320-060-14R1 SD_DRILL_13.2MM_5XD_A	02897981	13,2 0.520	60,0 2.362	124,0 4.882	79,0 3.110	45,0 1.772	77,0 3.031	14,0 0.551	140°	TiAIN	IT9
SD1105A-1330-060-14R1 SD_DRILL_13.3MM_5XD_A	02897982	13,3 0.524	60,0 2.362	124,0 4.882	79,0 3.110	45,0 1.772	77,0 3.031	14,0 0.551	140°	TiAIN	IT9
SD1105A-1340-060-14R1 SD_DRILL_13.4MM_5XD_A	02897983	13,4 0.528	60,0 2.362	124,0 4.882	79,0 3.110	45,0 1.772	77,0 3.031	14,0 0.551	140°	TiAIN	IT9
SD1105A-1349-060-14R1 SD_DRILL_17/32_5XD_A	02897984	13,494 0.531	60,0 2.362	124,0 4.882	79,0 3.110	45,0 1.772	77,0 3.031	14,0 0.551	140°	TiAIN	IT9
SD1105A-1350-060-14R1 SD_DRILL_13.5MM_5XD_A	02897985	13,5 0.531	60,0 2.362	124,0 4.882	79,0 3.110	45,0 1.772	77,0 3.031	14,0 0.551	140°	TiAIN	IT9
SD1105A-1360-060-14R1 SD_DRILL_13.6MM_5XD_A	02897986	13,6 0.535	60,0 2.362	124,0 4.882	79,0 3.110	45,0 1.772	77,0 3.031	14,0 0.551	140°	TiAIN	IT9
SD1105A-1370-060-14R1 SD_DRILL_13.7MM_5XD_A	02897987	13,7 0.539	60,0 2.362	124,0 4.882	79,0 3.110	45,0 1.772	77,0 3.031	14,0 0.551	140°	TiAIN	IT9
SD1105A-1380-060-14R1 SD_DRILL_13.8MM_5XD_A	02897988	13,8 0.543	60,0 2.362	124,0 4.882	79,0 3.110	45,0 1.772	77,0 3.031	14,0 0.551	140°	TiAIN	IT9
SD1105A-1390-060-14R1 SD_DRILL_35/64_5XD_A	02897989	13,9 0.547	60,0 2.362	124,0 4.882	79,0 3.110	45,0 1.772	77,0 3.031	14,0 0.551	140°	TiAIN	IT9
SD1105A-1400-060-14R1 SD_DRILL_14.0MM_5XD_A	02897990	14,0 0.551	60,0 2.362	124,0 4.882	79,0 3.110	45,0 1.772	77,0 3.031	14,0 0.551	140°	TiAIN	IT9
SD1105A-1410-063-16R1 SD_DRILL_14.1MM_5XD_A	02897991	14,1 0.555	63,0 2.480	133,0 5.236	85,0 3.346	48,0 1.890	83,0 3.268	16,0 0.630	140°	TiAIN	IT9
SD1105A-1420-063-16R1 SD_DRILL_14.2MM_5XD_A	02897992	14,2 0.559	63,0 2.480	133,0 5.236	85,0 3.346	48,0 1.890	83,0 3.268	16,0 0.630	140°	TiAIN	IT9

Introduzione

Foratura

Alesatura

Barenatura

Allegato

Codice di ordinazione	Codice prodotto	DC	LU	OAL	LFS	LS	LCF	DMM	Angolo di punta	Rivestimento	Tolleranza foro
		mm Inch	mm Inch	mm Inch	mm Inch	mm Inch	mm Inch	mm Inch			
SD1105A-1429-063-16R1 SD_DRILL_9/16_5XD_A	02897993	14,288 0.563	63,0 2.480	133,0 5.236	85,0 3.346	48,0 1.890	83,0 3.268	16,0 0.630	140°	TiAIN	IT9
SD1105A-1430-063-16R1 SD_DRILL_14.3MM_5XD_A	02897994	14,3 0.563	63,0 2.480	133,0 5.236	85,0 3.346	48,0 1.890	83,0 3.268	16,0 0.630	140°	TiAIN	IT9
SD1105A-1440-063-16R1 SD_DRILL_14.4MM_5XD_A	02897995	14,4 0.567	63,0 2.480	133,0 5.236	85,0 3.346	48,0 1.890	83,0 3.268	16,0 0.630	140°	TiAIN	IT9
SD1105A-1450-063-16R1 SD_DRILL_14.5MM_5XD_A	02897996	14,5 0.571	63,0 2.480	133,0 5.236	85,0 3.346	48,0 1.890	83,0 3.268	16,0 0.630	140°	TiAIN	IT9
SD1105A-1460-063-16R1 SD_DRILL_14.6MM_5XD_A	02897997	14,6 0.575	63,0 2.480	133,0 5.236	85,0 3.346	48,0 1.890	83,0 3.268	16,0 0.630	140°	TiAIN	IT9
SD1105A-1470-063-16R1 SD_DRILL_14.7MM_5XD_A	02897998	14,7 0.579	63,0 2.480	133,0 5.236	85,0 3.346	48,0 1.890	83,0 3.268	16,0 0.630	140°	TiAIN	IT9
SD1105A-1475-063-16R1 SD_DRILL_14.75MM_5XD_A	02897999	14,75 0.581	63,0 2.480	133,0 5.236	85,0 3.346	48,0 1.890	83,0 3.268	16,0 0.630	140°	TiAIN	IT9
SD1105A-1480-063-16R1 SD_DRILL_14.8MM_5XD_A	02898000	14,8 0.583	63,0 2.480	133,0 5.236	85,0 3.346	48,0 1.890	83,0 3.268	16,0 0.630	140°	TiAIN	IT9
SD1105A-1490-063-16R1 SD_DRILL_14.9MM_5XD_A	02898001	14,9 0.587	63,0 2.480	133,0 5.236	85,0 3.346	48,0 1.890	83,0 3.268	16,0 0.630	140°	TiAIN	IT9
SD1105A-1500-063-16R1 SD_DRILL_15.0MM_5XD_A	02898002	15,0 0.591	63,0 2.480	133,0 5.236	85,0 3.346	48,0 1.890	83,0 3.268	16,0 0.630	140°	TiAIN	IT9
SD1105A-1510-063-16R1 SD_DRILL_15.1MM_5XD_A	02898003	15,1 0.594	63,0 2.480	133,0 5.236	85,0 3.346	48,0 1.890	83,0 3.268	16,0 0.630	140°	TiAIN	IT9
SD1105A-1520-063-16R1 SD_DRILL_15.2MM_5XD_A	02898004	15,2 0.598	63,0 2.480	133,0 5.236	85,0 3.346	48,0 1.890	83,0 3.268	16,0 0.630	140°	TiAIN	IT9
SD1105A-1530-063-16R1 SD_DRILL_15.3MM_5XD_A	02898005	15,3 0.602	63,0 2.480	133,0 5.236	85,0 3.346	48,0 1.890	83,0 3.268	16,0 0.630	140°	TiAIN	IT9
SD1105A-1540-063-16R1 SD_DRILL_15.4MM_5XD_A	02898006	15,4 0.606	63,0 2.480	133,0 5.236	85,0 3.346	48,0 1.890	83,0 3.268	16,0 0.630	140°	TiAIN	IT9
SD1105A-1550-063-16R1 SD_DRILL_15.5MM_5XD_A	02898007	15,5 0.610	63,0 2.480	133,0 5.236	85,0 3.346	48,0 1.890	83,0 3.268	16,0 0.630	140°	TiAIN	IT9
SD1105A-1560-063-16R1 SD_DRILL_15.6MM_5XD_A	02898008	15,6 0.614	63,0 2.480	133,0 5.236	85,0 3.346	48,0 1.890	83,0 3.268	16,0 0.630	140°	TiAIN	IT9
SD1105A-1570-063-16R1 SD_DRILL_15.7MM_5XD_A	02898009	15,7 0.618	63,0 2.480	133,0 5.236	85,0 3.346	48,0 1.890	83,0 3.268	16,0 0.630	140°	TiAIN	IT9
SD1105A-1580-063-16R1 SD_DRILL_15.8MM_5XD_A	02898010	15,8 0.622	63,0 2.480	133,0 5.236	85,0 3.346	48,0 1.890	83,0 3.268	16,0 0.630	140°	TiAIN	IT9
SD1105A-1588-063-16R1 SD_DRILL_5/8_5XD_A	02898011	15,875 0.625	63,0 2.480	133,0 5.236	85,0 3.346	48,0 1.890	83,0 3.268	16,0 0.630	140°	TiAIN	IT9
SD1105A-1590-063-16R1 SD_DRILL_15.9MM_5XD_A	02898012	15,9 0.626	63,0 2.480	133,0 5.236	85,0 3.346	48,0 1.890	83,0 3.268	16,0 0.630	140°	TiAIN	IT9
SD1105A-1600-063-16R1 SD_DRILL_16.0MM_5XD_A	02898013	16,0 0.630	63,0 2.480	133,0 5.236	85,0 3.346	48,0 1.890	83,0 3.268	16,0 0.630	140°	TiAIN	IT9
SD1105A-1610-071-18R1 SD_DRILL_16.1MM_5XD_A	02898014	16,1 0.634	71,0 2.795	143,0 5.630	95,0 3.740	48,0 1.890	93,0 3.661	18,0 0.709	140°	TiAIN	IT9
SD1105A-1620-071-18R1 SD_DRILL_16.2MM_5XD_A	02898015	16,2 0.638	71,0 2.795	143,0 5.630	95,0 3.740	48,0 1.890	93,0 3.661	18,0 0.709	140°	TiAIN	IT9
SD1105A-1630-071-18R1 SD_DRILL_16.3MM_5XD_A	02898016	16,3 0.642	71,0 2.795	143,0 5.630	95,0 3.740	48,0 1.890	93,0 3.661	18,0 0.709	140°	TiAIN	IT9
SD1105A-1640-071-18R1 SD_DRILL_16.4MM_5XD_A	02898017	16,4 0.646	71,0 2.795	143,0 5.630	95,0 3.740	48,0 1.890	93,0 3.661	18,0 0.709	140°	TiAIN	IT9
SD1105A-1650-071-18R1 SD_DRILL_16.5MM_5XD_A	02898018	16,5 0.650	71,0 2.795	143,0 5.630	95,0 3.740	48,0 1.890	93,0 3.661	18,0 0.709	140°	TiAIN	IT9
SD1105A-1660-071-18R1 SD_DRILL_16.6MM_5XD_A	02898019	16,6 0.654	71,0 2.795	143,0 5.630	95,0 3.740	48,0 1.890	93,0 3.661	18,0 0.709	140°	TiAIN	IT9
SD1105A-1670-071-18R1 SD_DRILL_16.7MM_5XD_A	02898020	16,7 0.657	71,0 2.795	143,0 5.630	95,0 3.740	48,0 1.890	93,0 3.661	18,0 0.709	140°	TiAIN	IT9
SD1105A-1675-071-18R1 SD_DRILL_16.75MM_5XD_A	02898021	16,75 0.659	71,0 2.795	143,0 5.630	95,0 3.740	48,0 1.890	93,0 3.661	18,0 0.709	140°	TiAIN	IT9
SD1105A-1680-071-18R1 SD_DRILL_16.8MM_5XD_A	02898022	16,8 0.661	71,0 2.795	143,0 5.630	95,0 3.740	48,0 1.890	93,0 3.661	18,0 0.709	140°	TiAIN	IT9
SD1105A-1690-071-18R1 SD_DRILL_16.9MM_5XD_A	02898023	16,9 0.665	71,0 2.795	143,0 5.630	95,0 3.740	48,0 1.890	93,0 3.661	18,0 0.709	140°	TiAIN	IT9

Codice di ordinazione	Codice prodotto	DC	LU	OAL	LFS	LS	LCF	DMM	Angolo di punta	Rivesti-mento	Tolleranza foro
		mm Inch	mm Inch	mm Inch	mm Inch	mm Inch	mm Inch	mm Inch			
SD1105A-1700-071-18R1 SD_DRILL_17.0MM_5XD_A	02898024	17,0 0.669	71,0 2.795	143,0 5.630	95,0 3.740	48,0 1.890	93,0 3.661	18,0 0.709	140°	TiAIN	IT9
SD1105A-1710-071-18R1 SD_DRILL_17.1MM_5XD_A	02898025	17,1 0.673	71,0 2.795	143,0 5.630	95,0 3.740	48,0 1.890	93,0 3.661	18,0 0.709	140°	TiAIN	IT9
SD1105A-1720-071-18R1 SD_DRILL_17.2MM_5XD_A	02898026	17,2 0.677	71,0 2.795	143,0 5.630	95,0 3.740	48,0 1.890	93,0 3.661	18,0 0.709	140°	TiAIN	IT9
SD1105A-1730-071-18R1 SD_DRILL_17.3MM_5XD_A	02898027	17,3 0.681	71,0 2.795	143,0 5.630	95,0 3.740	48,0 1.890	93,0 3.661	18,0 0.709	140°	TiAIN	IT9
SD1105A-1740-071-18R1 SD_DRILL_17.4MM_5XD_A	02898028	17,4 0.685	71,0 2.795	143,0 5.630	95,0 3.740	48,0 1.890	93,0 3.661	18,0 0.709	140°	TiAIN	IT9
SD1105A-1750-071-18R1 SD_DRILL_17.5MM_5XD_A	02898029	17,5 0.689	71,0 2.795	143,0 5.630	95,0 3.740	48,0 1.890	93,0 3.661	18,0 0.709	140°	TiAIN	IT9
SD1105A-1760-071-18R1 SD_DRILL_17.6MM_5XD_A	02898030	17,6 0.693	71,0 2.795	143,0 5.630	95,0 3.740	48,0 1.890	93,0 3.661	18,0 0.709	140°	TiAIN	IT9
SD1105A-1770-071-18R1 SD_DRILL_17.7MM_5XD_A	02898031	17,7 0.697	71,0 2.795	143,0 5.630	95,0 3.740	48,0 1.890	93,0 3.661	18,0 0.709	140°	TiAIN	IT9
SD1105A-1780-071-18R1 SD_DRILL_17.8MM_5XD_A	02898032	17,8 0.701	71,0 2.795	143,0 5.630	95,0 3.740	48,0 1.890	93,0 3.661	18,0 0.709	140°	TiAIN	IT9
SD1105A-1790-071-18R1 SD_DRILL_17.9MM_5XD_A	02898033	17,9 0.705	71,0 2.795	143,0 5.630	95,0 3.740	48,0 1.890	93,0 3.661	18,0 0.709	140°	TiAIN	IT9
SD1105A-1800-071-18R1 SD_DRILL_18.0MM_5XD_A	02898034	18,0 0.709	71,0 2.795	143,0 5.630	95,0 3.740	48,0 1.890	93,0 3.661	18,0 0.709	140°	TiAIN	IT9
SD1105A-1810-077-20R1 SD_DRILL_18.1MM_5XD_A	02898035	18,1 0.713	77,0 3.031	153,0 6.024	103,0 4.055	50,0 1.969	101,0 3.976	20,0 0.787	140°	TiAIN	IT9
SD1105A-1820-077-20R1 SD_DRILL_18.2MM_5XD_A	02898036	18,2 0.717	77,0 3.031	153,0 6.024	103,0 4.055	50,0 1.969	101,0 3.976	20,0 0.787	140°	TiAIN	IT9
SD1105A-1830-077-20R1 SD_DRILL_18.3MM_5XD_A	02898037	18,3 0.720	77,0 3.031	153,0 6.024	103,0 4.055	50,0 1.969	101,0 3.976	20,0 0.787	140°	TiAIN	IT9
SD1105A-1840-077-20R1 SD_DRILL_18.4MM_5XD_A	02898038	18,4 0.724	77,0 3.031	153,0 6.024	103,0 4.055	50,0 1.969	101,0 3.976	20,0 0.787	140°	TiAIN	IT9
SD1105A-1850-077-20R1 SD_DRILL_18.5MM_5XD_A	02898039	18,5 0.728	77,0 3.031	153,0 6.024	103,0 4.055	50,0 1.969	101,0 3.976	20,0 0.787	140°	TiAIN	IT9
SD1105A-1860-077-20R1 SD_DRILL_18.6MM_5XD_A	02898040	18,6 0.732	77,0 3.031	153,0 6.024	103,0 4.055	50,0 1.969	101,0 3.976	20,0 0.787	140°	TiAIN	IT9
SD1105A-1870-077-20R1 SD_DRILL_18.7MM_5XD_A	02898041	18,7 0.736	77,0 3.031	153,0 6.024	103,0 4.055	50,0 1.969	101,0 3.976	20,0 0.787	140°	TiAIN	IT9
SD1105A-1880-077-20R1 SD_DRILL_18.8MM_5XD_A	02898042	18,8 0.740	77,0 3.031	153,0 6.024	103,0 4.055	50,0 1.969	101,0 3.976	20,0 0.787	140°	TiAIN	IT9
SD1105A-1890-077-20R1 SD_DRILL_18.9MM_5XD_A	02898043	18,9 0.744	77,0 3.031	153,0 6.024	103,0 4.055	50,0 1.969	101,0 3.976	20,0 0.787	140°	TiAIN	IT9
SD1105A-1900-077-20R1 SD_DRILL_19.0MM_5XD_A	02898044	19,0 0.748	77,0 3.031	153,0 6.024	103,0 4.055	50,0 1.969	101,0 3.976	20,0 0.787	140°	TiAIN	IT9
SD1105A-1905-077-20R1 SD_DRILL_3/4_5XD_A	02898045	19,05 0.750	77,0 3.031	153,0 6.024	103,0 4.055	50,0 1.969	101,0 3.976	20,0 0.787	140°	TiAIN	IT9
SD1105A-1910-077-20R1 SD_DRILL_19.1MM_5XD_A	02898046	19,1 0.752	77,0 3.031	153,0 6.024	103,0 4.055	50,0 1.969	101,0 3.976	20,0 0.787	140°	TiAIN	IT9
SD1105A-1920-077-20R1 SD_DRILL_19.2MM_5XD_A	02898047	19,2 0.756	77,0 3.031	153,0 6.024	103,0 4.055	50,0 1.969	101,0 3.976	20,0 0.787	140°	TiAIN	IT9
SD1105A-1930-077-20R1 SD_DRILL_19.3MM_5XD_A	02898048	19,3 0.760	77,0 3.031	153,0 6.024	103,0 4.055	50,0 1.969	101,0 3.976	20,0 0.787	140°	TiAIN	IT9
SD1105A-1940-077-20R1 SD_DRILL_19.4MM_5XD_A	02898049	19,4 0.764	77,0 3.031	153,0 6.024	103,0 4.055	50,0 1.969	101,0 3.976	20,0 0.787	140°	TiAIN	IT9
SD1105A-1950-077-20R1 SD_DRILL_19.5MM_5XD_A	02898050	19,5 0.768	77,0 3.031	153,0 6.024	103,0 4.055	50,0 1.969	101,0 3.976	20,0 0.787	140°	TiAIN	IT9
SD1105A-1960-077-20R1 SD_DRILL_19.6MM_5XD_A	02898051	19,6 0.772	77,0 3.031	153,0 6.024	103,0 4.055	50,0 1.969	101,0 3.976	20,0 0.787	140°	TiAIN	IT9
SD1105A-1970-077-20R1 SD_DRILL_19.7MM_5XD_A	02898052	19,7 0.776	77,0 3.031	153,0 6.024	103,0 4.055	50,0 1.969	101,0 3.976	20,0 0.787	140°	TiAIN	IT9
SD1105A-1980-077-20R1 SD_DRILL_19.8MM_5XD_A	02898053	19,8 0.780	77,0 3.031	153,0 6.024	103,0 4.055	50,0 1.969	101,0 3.976	20,0 0.787	140°	TiAIN	IT9

Introduzione

Foratura

Alesatura

Barenatura

Allegato

Codice di ordinazione	Codice prodotto	DC	LU	OAL	LFS	LS	LCF	DMM	Angolo di punta	Rivestimento	Tolleranza foro
		mm <i>Inch</i>	mm <i>Inch</i>	mm <i>Inch</i>	mm <i>Inch</i>	mm <i>Inch</i>	mm <i>Inch</i>	mm <i>Inch</i>			
SD1105A-1990-077-20R1 <i>SD_DRILL_19.9MM_5XD_A</i>	02898054	19,9 <i>0.783</i>	77,0 <i>3.031</i>	153,0 <i>6.024</i>	103,0 <i>4.055</i>	50,0 <i>1.969</i>	101,0 <i>3.976</i>	20,0 <i>0.787</i>	140°	TiAIN	IT9
SD1105A-2000-077-20R1 <i>SD_DRILL_20.0MM_5XD_A</i>	02898055	20,0 <i>0.787</i>	77,0 <i>3.031</i>	153,0 <i>6.024</i>	103,0 <i>4.055</i>	50,0 <i>1.969</i>	101,0 <i>3.976</i>	20,0 <i>0.787</i>	140°	TiAIN	IT9

Introduzione

Foratura

Alesatura

Barenatura

Allegato

SD1108A

Profondità di foratura ~ 8 x D – Misure metriche/Pollici

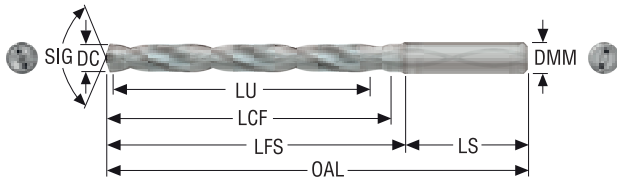

- Codolo cilindrico DIN 6537A
- Tolleranza DC m7
- Adduzione refrigerante interna
- Per i parametri di taglio raccomandati, vedere pagina(e) 143
- Per i diametri intermedi, utilizzare MyDesign.

Codice di ordinazione	Codice prodotto	DC	LU	OAL	LFS	LS	LCF	DMM	Angolo di punta	Rivestimento	Tolleranza foro
		mm Inch	mm Inch	mm Inch	mm Inch	mm Inch	mm Inch	mm Inch			
SD1108A-0300-028-06R1 SD_DRILL_3.0MM_8XD_A	03295178	3,0 0.118	28,0 1.102	74,0 2.913	38,0 1.496	36,0 1.417	34,0 1.339	6,0 0.236	140°	TiAlN	IT9
SD1108A-0310-028-06R1 SD_DRILL_3.1MM_8XD_A	03295179	3,1 0.122	28,0 1.102	74,0 2.913	38,0 1.496	36,0 1.417	34,0 1.339	6,0 0.236	140°	TiAlN	IT9
SD1108A-0318-028-06R1 SD_DRILL_1/8_8XD_A	03323680	3,175 0.125	28,0 1.102	74,0 2.913	38,0 1.496	36,0 1.417	34,0 1.339	6,0 0.236	140°	TiAlN	IT9
SD1108A-0320-028-06R1 SD_DRILL_3.2MM_8XD_A	03295180	3,2 0.126	28,0 1.102	74,0 2.913	38,0 1.496	36,0 1.417	34,0 1.339	6,0 0.236	140°	TiAlN	IT9
SD1108A-0330-028-06R1 SD_DRILL_3.3MM_8XD_A	03295181	3,3 0.130	28,0 1.102	74,0 2.913	38,0 1.496	36,0 1.417	34,0 1.339	6,0 0.236	140°	TiAlN	IT9
SD1108A-0340-028-06R1 SD_DRILL_3.4MM_8XD_A	03295182	3,4 0.134	28,0 1.102	74,0 2.913	38,0 1.496	36,0 1.417	34,0 1.339	6,0 0.236	140°	TiAlN	IT9
SD1108A-0350-028-06R1 SD_DRILL_3.5MM_8XD_A	03295183	3,5 0.138	28,0 1.102	74,0 2.913	38,0 1.496	36,0 1.417	34,0 1.339	6,0 0.236	140°	TiAlN	IT9
SD1108A-0357-028-06R1 SD_DRILL_9/64_8XD_A	03323681	3,572 0.141	28,0 1.102	74,0 2.913	38,0 1.496	36,0 1.417	34,0 1.339	6,0 0.236	140°	TiAlN	IT9
SD1108A-0360-028-06R1 SD_DRILL_3.6MM_8XD_A	03295184	3,6 0.142	28,0 1.102	74,0 2.913	38,0 1.496	36,0 1.417	34,0 1.339	6,0 0.236	140°	TiAlN	IT9
SD1108A-0370-028-06R1 SD_DRILL_3.7MM_8XD_A	03295185	3,7 0.146	28,0 1.102	74,0 2.913	38,0 1.496	36,0 1.417	34,0 1.339	6,0 0.236	140°	TiAlN	IT9
SD1108A-0380-037-06R1 SD_DRILL_3.8MM_8XD_A	03295186	3,8 0.150	37,0 1.457	85,0 3.346	49,0 1.929	36,0 1.417	45,0 1.772	6,0 0.236	140°	TiAlN	IT9
SD1108A-0390-037-06R1 SD_DRILL_3.9MM_8XD_A	03295187	3,9 0.154	37,0 1.457	85,0 3.346	49,0 1.929	36,0 1.417	45,0 1.772	6,0 0.236	140°	TiAlN	IT9
SD1108A-0397-037-06R1 SD_DRILL_5/32_8XD_A	03323682	3,969 0.156	37,0 1.457	85,0 3.346	49,0 1.929	36,0 1.417	45,0 1.772	6,0 0.236	140°	TiAlN	IT9
SD1108A-0400-037-06R1 SD_DRILL_4.0MM_8XD_A	03295188	4,0 0.157	37,0 1.457	85,0 3.346	49,0 1.929	36,0 1.417	45,0 1.772	6,0 0.236	140°	TiAlN	IT9
SD1108A-0410-037-06R1 SD_DRILL_4.1MM_8XD_A	03295189	4,1 0.161	37,0 1.457	85,0 3.346	49,0 1.929	36,0 1.417	45,0 1.772	6,0 0.236	140°	TiAlN	IT9
SD1108A-0420-037-06R1 SD_DRILL_4.2MM_8XD_A	03295190	4,2 0.165	37,0 1.457	85,0 3.346	49,0 1.929	36,0 1.417	45,0 1.772	6,0 0.236	140°	TiAlN	IT9
SD1108A-0430-037-06R1 SD_DRILL_4.3MM_8XD_A	03295191	4,3 0.169	37,0 1.457	85,0 3.346	49,0 1.929	36,0 1.417	45,0 1.772	6,0 0.236	140°	TiAlN	IT9
SD1108A-0437-037-06R1 SD_DRILL_11/64_8XD_A	03323683	4,366 0.172	37,0 1.457	85,0 3.346	49,0 1.929	36,0 1.417	45,0 1.772	6,0 0.236	140°	TiAlN	IT9
SD1108A-0440-037-06R1 SD_DRILL_4.4MM_8XD_A	03295192	4,4 0.173	37,0 1.457	85,0 3.346	49,0 1.929	36,0 1.417	45,0 1.772	6,0 0.236	140°	TiAlN	IT9
SD1108A-0450-037-06R1 SD_DRILL_4.5MM_8XD_A	03295193	4,5 0.177	37,0 1.457	85,0 3.346	49,0 1.929	36,0 1.417	45,0 1.772	6,0 0.236	140°	TiAlN	IT9
SD1108A-0460-037-06R1 SD_DRILL_4.6MM_8XD_A	03295194	4,6 0.181	37,0 1.457	85,0 3.346	49,0 1.929	36,0 1.417	45,0 1.772	6,0 0.236	140°	TiAlN	IT9

Introduzione

Foratura

Alesatura

Barenatura

Allegato

	Codice di ordinazione	Codice prodotto	DC	LU	OAL	LFS	LS	LCF	DMM	Angolo di punta	Rivestimento	Tolleranza foro	
			mm Inch	mm Inch	mm Inch	mm Inch	mm Inch	mm Inch	mm Inch				
Introduzione	SD1108A-0470-037-06R1 SD_DRILL_4.7MM_8XD_A	03295195	4,7 0.185	37,0 1.457	85,0 3.346	49,0 1.929	36,0 1.417	45,0 1.772	6,0 0.236	140°	TiAIN	IT9	
	SD1108A-0476-048-06R1 SD_DRILL_3/16_8XD_A	03323684	4,763 0.188	48,0 1.890	97,0 3.819	61,0 2.402	36,0 1.417	57,0 2.244	6,0 0.236	140°	TiAIN	IT9	
	SD1108A-0480-048-06R1 SD_DRILL_4.8MM_8XD_A	03295197	4,8 0.189	48,0 1.890	97,0 3.819	61,0 2.402	36,0 1.417	57,0 2.244	6,0 0.236	140°	TiAIN	IT9	
	SD1108A-0490-048-06R1 SD_DRILL_4.9MM_8XD_A	03295198	4,9 0.193	48,0 1.890	97,0 3.819	61,0 2.402	36,0 1.417	57,0 2.244	6,0 0.236	140°	TiAIN	IT9	
	SD1108A-0500-048-06R1 SD_DRILL_5.0MM_8XD_A	03295199	5,0 0.197	48,0 1.890	97,0 3.819	61,0 2.402	36,0 1.417	57,0 2.244	6,0 0.236	140°	TiAIN	IT9	
Foratura	SD1108A-0510-048-06R1 SD_DRILL_5.1MM_8XD_A	03295200	5,1 0.201	48,0 1.890	97,0 3.819	61,0 2.402	36,0 1.417	57,0 2.244	6,0 0.236	140°	TiAIN	IT9	
	SD1108A-0516-048-06R1 SD_DRILL_13/64_8XD_A	03323685	5,159 0.203	48,0 1.890	97,0 3.819	61,0 2.402	36,0 1.417	57,0 2.244	6,0 0.236	140°	TiAIN	IT9	
	SD1108A-0520-048-06R1 SD_DRILL_5.2MM_8XD_A	03295201	5,2 0.205	48,0 1.890	97,0 3.819	61,0 2.402	36,0 1.417	57,0 2.244	6,0 0.236	140°	TiAIN	IT9	
	SD1108A-0530-048-06R1 SD_DRILL_5.3MM_8XD_A	03295202	5,3 0.209	48,0 1.890	97,0 3.819	61,0 2.402	36,0 1.417	57,0 2.244	6,0 0.236	140°	TiAIN	IT9	
	SD1108A-0540-048-06R1 SD_DRILL_5.4MM_8XD_A	03295203	5,4 0.213	48,0 1.890	97,0 3.819	61,0 2.402	36,0 1.417	57,0 2.244	6,0 0.236	140°	TiAIN	IT9	
	SD1108A-0550-048-06R1 SD_DRILL_5.5MM_8XD_A	03295204	5,5 0.217	48,0 1.890	97,0 3.819	61,0 2.402	36,0 1.417	57,0 2.244	6,0 0.236	140°	TiAIN	IT9	
	SD1108A-0556-048-06R1 SD_DRILL_7/32_8XD_A	03295206	5,556 0.219	48,0 1.890	97,0 3.819	61,0 2.402	36,0 1.417	57,0 2.244	6,0 0.236	140°	TiAIN	IT9	
	SD1108A-0560-048-06R1 SD_DRILL_5.6MM_8XD_A	03295207	5,6 0.220	48,0 1.890	97,0 3.819	61,0 2.402	36,0 1.417	57,0 2.244	6,0 0.236	140°	TiAIN	IT9	
	SD1108A-0570-048-06R1 SD_DRILL_5.7MM_8XD_A	03295208	5,7 0.224	48,0 1.890	97,0 3.819	61,0 2.402	36,0 1.417	57,0 2.244	6,0 0.236	140°	TiAIN	IT9	
	SD1108A-0580-048-06R1 SD_DRILL_5.8MM_8XD_A	03295012	5,8 0.228	48,0 1.890	97,0 3.819	61,0 2.402	36,0 1.417	57,0 2.244	6,0 0.236	140°	TiAIN	IT9	
	SD1108A-0590-048-06R1 SD_DRILL_5.9MM_8XD_A	03295013	5,9 0.232	48,0 1.890	97,0 3.819	61,0 2.402	36,0 1.417	57,0 2.244	6,0 0.236	140°	TiAIN	IT9	
	SD1108A-0595-048-06R1 SD_DRILL_15/64_8XD_A	03323686	5,953 0.234	48,0 1.890	97,0 3.819	61,0 2.402	36,0 1.417	57,0 2.244	6,0 0.236	140°	TiAIN	IT9	
	SD1108A-0600-048-06R1 SD_DRILL_6.0MM_8XD_A	03295014	6,0 0.236	48,0 1.890	97,0 3.819	61,0 2.402	36,0 1.417	57,0 2.244	6,0 0.236	140°	TiAIN	IT9	
	Alesatura	SD1108A-0610-055-08R1 SD_DRILL_6.1MM_8XD_A	03295015	6,1 0.240	55,0 2.165	106,0 4.173	70,0 2.756	36,0 1.417	66,0 2.598	8,0 0.315	140°	TiAIN	IT9
		SD1108A-0620-055-08R1 SD_DRILL_6.2MM_8XD_A	03295016	6,2 0.244	55,0 2.165	106,0 4.173	70,0 2.756	36,0 1.417	66,0 2.598	8,0 0.315	140°	TiAIN	IT9
SD1108A-0630-055-08R1 SD_DRILL_6.3MM_8XD_A		03295017	6,3 0.248	55,0 2.165	106,0 4.173	70,0 2.756	36,0 1.417	66,0 2.598	8,0 0.315	140°	TiAIN	IT9	
SD1108A-0635-055-08R1 SD_DRILL_1/4_8XD_A		03295018	6,35 0.250	55,0 2.165	106,0 4.173	70,0 2.756	36,0 1.417	66,0 2.598	8,0 0.315	140°	TiAIN	IT9	
SD1108A-0640-055-08R1 SD_DRILL_6.4MM_8XD_A		03295019	6,4 0.252	55,0 2.165	106,0 4.173	70,0 2.756	36,0 1.417	66,0 2.598	8,0 0.315	140°	TiAIN	IT9	
SD1108A-0650-055-08R1 SD_DRILL_6.5MM_8XD_A		03295020	6,5 0.256	55,0 2.165	106,0 4.173	70,0 2.756	36,0 1.417	66,0 2.598	8,0 0.315	140°	TiAIN	IT9	
SD1108A-0660-055-08R1 SD_DRILL_6.6MM_8XD_A		03295021	6,6 0.260	55,0 2.165	106,0 4.173	70,0 2.756	36,0 1.417	66,0 2.598	8,0 0.315	140°	TiAIN	IT9	
SD1108A-0670-055-08R1 SD_DRILL_6.7MM_8XD_A		03295022	6,7 0.264	55,0 2.165	106,0 4.173	70,0 2.756	36,0 1.417	66,0 2.598	8,0 0.315	140°	TiAIN	IT9	
SD1108A-0675-055-08R1 SD_DRILL_17/64_8XD_A		03323687	6,747 0.266	55,0 2.165	106,0 4.173	70,0 2.756	36,0 1.417	66,0 2.598	8,0 0.315	140°	TiAIN	IT9	
SD1108A-0680-055-08R1 SD_DRILL_6.8MM_8XD_A		03295023	6,8 0.268	55,0 2.165	106,0 4.173	70,0 2.756	36,0 1.417	66,0 2.598	8,0 0.315	140°	TiAIN	IT9	
SD1108A-0690-055-08R1 SD_DRILL_6.9MM_8XD_A		03295024	6,9 0.272	55,0 2.165	106,0 4.173	70,0 2.756	36,0 1.417	66,0 2.598	8,0 0.315	140°	TiAIN	IT9	
SD1108A-0700-055-08R1 SD_DRILL_7.0MM_8XD_A		03295025	7,0 0.276	55,0 2.165	106,0 4.173	70,0 2.756	36,0 1.417	66,0 2.598	8,0 0.315	140°	TiAIN	IT9	
SD1108A-0710-064-08R1 SD_DRILL_7.1MM_8XD_A		03295026	7,1 0.280	64,0 2.520	116,0 4.567	80,0 3.150	36,0 1.417	76,0 2.992	8,0 0.315	140°	TiAIN	IT9	

Codice di ordinazione	Codice prodotto	DC	LU	OAL	LFS	LS	LCF	DMM	Angolo di punta	Rivestimento	Tolleranza foro
		mm Inch	mm Inch	mm Inch	mm Inch	mm Inch	mm Inch	mm Inch			
SD1108A-0714-064-08R1 SD_DRILL_9/32_8XD_A	03323688	7,144 0.281	64,0 2.520	116,0 4.567	80,0 3.150	36,0 1.417	76,0 2.992	8,0 0.315	140°	TiAIN	IT9
SD1108A-0730-064-08R1 SD_DRILL_7.3MM_8XD_A	03323689	7,3 0.287	64,0 2.520	116,0 4.567	80,0 3.150	36,0 1.417	76,0 2.992	8,0 0.315	140°	TiAIN	IT9
SD1108A-0740-064-08R1 SD_DRILL_7.4MM_8XD_A	03295027	7,4 0.291	64,0 2.520	116,0 4.567	80,0 3.150	36,0 1.417	76,0 2.992	8,0 0.315	140°	TiAIN	IT9
SD1108A-0750-064-08R1 SD_DRILL_7.5MM_8XD_A	03295028	7,5 0.295	64,0 2.520	116,0 4.567	80,0 3.150	36,0 1.417	76,0 2.992	8,0 0.315	140°	TiAIN	IT9
SD1108A-0754-064-08R1 SD_DRILL_19/64_8XD_A	03323690	7,541 0.297	64,0 2.520	116,0 4.567	80,0 3.150	36,0 1.417	76,0 2.992	8,0 0.315	140°	TiAIN	IT9
SD1108A-0760-064-08R1 SD_DRILL_7.6MM_8XD_A	03323691	7,6 0.299	64,0 2.520	116,0 4.567	80,0 3.150	36,0 1.417	76,0 2.992	8,0 0.315	140°	TiAIN	IT9
SD1108A-0770-064-08R1 SD_DRILL_7.7MM_8XD_A	03295029	7,7 0.303	64,0 2.520	116,0 4.567	80,0 3.150	36,0 1.417	76,0 2.992	8,0 0.315	140°	TiAIN	IT9
SD1108A-0780-064-08R1 SD_DRILL_7.8MM_8XD_A	03295030	7,8 0.307	64,0 2.520	116,0 4.567	80,0 3.150	36,0 1.417	76,0 2.992	8,0 0.315	140°	TiAIN	IT9
SD1108A-0790-064-08R1 SD_DRILL_7.9MM_8XD_A	03295031	7,9 0.311	64,0 2.520	116,0 4.567	80,0 3.150	36,0 1.417	76,0 2.992	8,0 0.315	140°	TiAIN	IT9
SD1108A-0794-064-08R1 SD_DRILL_5/16_8XD_A	03323692	7,938 0.313	64,0 2.520	116,0 4.567	80,0 3.150	36,0 1.417	76,0 2.992	8,0 0.315	140°	TiAIN	IT9
SD1108A-0800-064-08R1 SD_DRILL_8.0MM_8XD_A	03295032	8,0 0.315	64,0 2.520	116,0 4.567	80,0 3.150	36,0 1.417	76,0 2.992	8,0 0.315	140°	TiAIN	IT9
SD1108A-0810-080-10R1 SD_DRILL_8.1MM_8XD_A	03295033	8,1 0.319	80,0 3.150	139,0 5.472	99,0 3.898	40,0 1.575	95,0 3.740	10,0 0.394	140°	TiAIN	IT9
SD1108A-0820-080-10R1 SD_DRILL_8.2MM_8XD_A	03295034	8,2 0.323	80,0 3.150	139,0 5.472	99,0 3.898	40,0 1.575	95,0 3.740	10,0 0.394	140°	TiAIN	IT9
SD1108A-0830-080-10R1 SD_DRILL_8.3MM_8XD_A	03295035	8,3 0.327	80,0 3.150	139,0 5.472	99,0 3.898	40,0 1.575	95,0 3.740	10,0 0.394	140°	TiAIN	IT9
SD1108A-0833-080-10R1 SD_DRILL_21/64_8XD_A	03323693	8,334 0.328	80,0 3.150	139,0 5.472	99,0 3.898	40,0 1.575	95,0 3.740	10,0 0.394	140°	TiAIN	IT9
SD1108A-0840-080-10R1 SD_DRILL_8.4MM_8XD_A	03295036	8,4 0.331	80,0 3.150	139,0 5.472	99,0 3.898	40,0 1.575	95,0 3.740	10,0 0.394	140°	TiAIN	IT9
SD1108A-0850-080-10R1 SD_DRILL_8.5MM_8XD_A	03295037	8,5 0.335	80,0 3.150	139,0 5.472	99,0 3.898	40,0 1.575	95,0 3.740	10,0 0.394	140°	TiAIN	IT9
SD1108A-0860-080-10R1 SD_DRILL_8.6MM_8XD_A	03295038	8,6 0.339	80,0 3.150	139,0 5.472	99,0 3.898	40,0 1.575	95,0 3.740	10,0 0.394	140°	TiAIN	IT9
SD1108A-0870-080-10R1 SD_DRILL_8.7MM_8XD_A	03295039	8,7 0.343	80,0 3.150	139,0 5.472	99,0 3.898	40,0 1.575	95,0 3.740	10,0 0.394	140°	TiAIN	IT9
SD1108A-0873-080-10R1 SD_DRILL_11/32_8XD_A	03323694	8,731 0.344	80,0 3.150	139,0 5.472	99,0 3.898	40,0 1.575	95,0 3.740	10,0 0.394	140°	TiAIN	IT9
SD1108A-0880-080-10R1 SD_DRILL_8.8MM_8XD_A	03295040	8,8 0.346	80,0 3.150	139,0 5.472	99,0 3.898	40,0 1.575	95,0 3.740	10,0 0.394	140°	TiAIN	IT9
SD1108A-0900-080-10R1 SD_DRILL_9.0MM_8XD_A	03295041	9,0 0.354	80,0 3.150	139,0 5.472	99,0 3.898	40,0 1.575	95,0 3.740	10,0 0.394	140°	TiAIN	IT9
SD1108A-0910-080-10R1 SD_DRILL_9.1MM_8XD_A	03295042	9,1 0.358	80,0 3.150	139,0 5.472	99,0 3.898	40,0 1.575	95,0 3.740	10,0 0.394	140°	TiAIN	IT9
SD1108A-0913-080-10R1 SD_DRILL_23/64_8XD_A	03323695	9,128 0.359	80,0 3.150	139,0 5.472	99,0 3.898	40,0 1.575	95,0 3.740	10,0 0.394	140°	TiAIN	IT9
SD1108A-0930-080-10R1 SD_DRILL_9.3MM_8XD_A	03295043	9,3 0.366	80,0 3.150	139,0 5.472	99,0 3.898	40,0 1.575	95,0 3.740	10,0 0.394	140°	TiAIN	IT9
SD1108A-0940-080-10R1 SD_DRILL_9.4MM_8XD_A	03295044	9,4 0.370	80,0 3.150	139,0 5.472	99,0 3.898	40,0 1.575	95,0 3.740	10,0 0.394	140°	TiAIN	IT9
SD1108A-0950-080-10R1 SD_DRILL_9.5MM_8XD_A	03295045	9,5 0.374	80,0 3.150	139,0 5.472	99,0 3.898	40,0 1.575	95,0 3.740	10,0 0.394	140°	TiAIN	IT9
SD1108A-0953-080-10R1 SD_DRILL_3/8_8XD_A	03323696	9,525 0.375	80,0 3.150	139,0 5.472	99,0 3.898	40,0 1.575	95,0 3.740	10,0 0.394	140°	TiAIN	IT9
SD1108A-0970-080-10R1 SD_DRILL_9.7MM_8XD_A	03295046	9,7 0.382	80,0 3.150	139,0 5.472	99,0 3.898	40,0 1.575	95,0 3.740	10,0 0.394	140°	TiAIN	IT9
SD1108A-0980-080-10R1 SD_DRILL_9.8MM_8XD_A	03295047	9,8 0.386	80,0 3.150	139,0 5.472	99,0 3.898	40,0 1.575	95,0 3.740	10,0 0.394	140°	TiAIN	IT9
SD1108A-0990-080-10R1 SD_DRILL_9.9MM_8XD_A	03295048	9,9 0.390	80,0 3.150	139,0 5.472	99,0 3.898	40,0 1.575	95,0 3.740	10,0 0.394	140°	TiAIN	IT9

Introduzione

Foratura

Alesatura

Barenatura

Allegato

	Codice di ordinazione	Codice prodotto	DC	LU	OAL	LFS	LS	LCF	DMM	Angolo di punta	Rivestimento	Tolleranza foro
			mm Inch	mm Inch	mm Inch	mm Inch	mm Inch	mm Inch	mm Inch			
Introduzione	SD1108A-0992-080-10R1 SD_DRILL_25/64_8XD_A	03323697	9,922 0.391	80,0 3.150	139,0 5.472	99,0 3.898	40,0 1.575	95,0 3.740	10,0 0.394	140°	TiAIN	IT9
	SD1108A-1000-080-10R1 SD_DRILL_10.0MM_8XD_A	03295049	10,0 0.394	80,0 3.150	139,0 5.472	99,0 3.898	40,0 1.575	95,0 3.740	10,0 0.394	140°	TiAIN	IT9
	SD1108A-1020-096-12R1 SD_DRILL_10.2MM_8XD_A	03295050	10,2 0.402	96,0 3.780	163,0 6.417	118,0 4.646	45,0 1.772	114,0 4.488	12,0 0.472	140°	TiAIN	IT9
	SD1108A-1030-096-12R1 SD_DRILL_10.3MM_8XD_A	03295051	10,3 0.406	96,0 3.780	163,0 6.417	118,0 4.646	45,0 1.772	114,0 4.488	12,0 0.472	140°	TiAIN	IT9
	SD1108A-1032-096-12R1 SD_DRILL_13/32_8XD_A	03323698	10,319 0.406	96,0 3.780	163,0 6.417	118,0 4.646	45,0 1.772	114,0 4.488	12,0 0.472	140°	TiAIN	IT9
Foratura	SD1108A-1040-096-12R1 SD_DRILL_10.4MM_8XD_A	03295053	10,4 0.409	96,0 3.780	163,0 6.417	118,0 4.646	45,0 1.772	114,0 4.488	12,0 0.472	140°	TiAIN	IT9
	SD1108A-1050-096-12R1 SD_DRILL_10.5MM_8XD_A	03295054	10,5 0.413	96,0 3.780	163,0 6.417	118,0 4.646	45,0 1.772	114,0 4.488	12,0 0.472	140°	TiAIN	IT9
	SD1108A-1070-096-12R1 SD_DRILL_10.7MM_8XD_A	03295055	10,7 0.421	96,0 3.780	163,0 6.417	118,0 4.646	45,0 1.772	114,0 4.488	12,0 0.472	140°	TiAIN	IT9
	SD1108A-1072-096-12R1 SD_DRILL_27/64_8XD_A	03323699	10,716 0.422	96,0 3.780	163,0 6.417	118,0 4.646	45,0 1.772	114,0 4.488	12,0 0.472	140°	TiAIN	IT9
	SD1108A-1080-096-12R1 SD_DRILL_10.8MM_8XD_A	03295056	10,8 0.425	96,0 3.780	163,0 6.417	118,0 4.646	45,0 1.772	114,0 4.488	12,0 0.472	140°	TiAIN	IT9
	SD1108A-1100-096-12R1 SD_DRILL_11.0MM_8XD_A	03295057	11,0 0.433	96,0 3.780	163,0 6.417	118,0 4.646	45,0 1.772	114,0 4.488	12,0 0.472	140°	TiAIN	IT9
	SD1108A-1111-096-12R1 SD_DRILL_7/16_8XD_A	03323700	11,113 0.438	96,0 3.780	163,0 6.417	118,0 4.646	45,0 1.772	114,0 4.488	12,0 0.472	140°	TiAIN	IT9
	SD1108A-1120-096-12R1 SD_DRILL_11.2MM_8XD_A	03295058	11,2 0.441	96,0 3.780	163,0 6.417	118,0 4.646	45,0 1.772	114,0 4.488	12,0 0.472	140°	TiAIN	IT9
	SD1108A-1130-096-12R1 SD_DRILL_11.3MM_8XD_A	03295059	11,3 0.445	96,0 3.780	163,0 6.417	118,0 4.646	45,0 1.772	114,0 4.488	12,0 0.472	140°	TiAIN	IT9
	SD1108A-1150-096-12R1 SD_DRILL_11.5MM_8XD_A	03295060	11,5 0.453	96,0 3.780	163,0 6.417	118,0 4.646	45,0 1.772	114,0 4.488	12,0 0.472	140°	TiAIN	IT9
	SD1108A-1170-096-12R1 SD_DRILL_11.7MM_8XD_A	03295061	11,7 0.461	96,0 3.780	163,0 6.417	118,0 4.646	45,0 1.772	114,0 4.488	12,0 0.472	140°	TiAIN	IT9
	SD1108A-1180-096-12R1 SD_DRILL_11.8MM_8XD_A	03295062	11,8 0.465	96,0 3.780	163,0 6.417	118,0 4.646	45,0 1.772	114,0 4.488	12,0 0.472	140°	TiAIN	IT9
	SD1108A-1190-096-12R1 SD_DRILL_11.9MM_8XD_A	03295063	11,9 0.469	96,0 3.780	163,0 6.417	118,0 4.646	45,0 1.772	114,0 4.488	12,0 0.472	140°	TiAIN	IT9
	Alesatura	SD1108A-1191-096-12R1 SD_DRILL_15/32_8XD_A	03323701	11,906 0.469	96,0 3.780	163,0 6.417	118,0 4.646	45,0 1.772	114,0 4.488	12,0 0.472	140°	TiAIN
SD1108A-1200-096-12R1 SD_DRILL_12.0MM_8XD_A		03295064	12,0 0.472	96,0 3.780	163,0 6.417	118,0 4.646	45,0 1.772	114,0 4.488	12,0 0.472	140°	TiAIN	IT9
SD1108A-1230-119-14R1 SD_DRILL_31/64_8XD_A		03295065	12,3 0.484	119,0 4.685	182,0 7.165	137,0 5.394	45,0 1.772	133,0 5.236	14,0 0.551	140°	TiAIN	IT9
SD1108A-1250-119-14R1 SD_DRILL_12.5MM_8XD_A		03295066	12,5 0.492	119,0 4.685	182,0 7.165	137,0 5.394	45,0 1.772	133,0 5.236	14,0 0.551	140°	TiAIN	IT9
SD1108A-1270-119-14R1 SD_DRILL_1/2_8XD_A		03295067	12,7 0.500	119,0 4.685	182,0 7.165	137,0 5.394	45,0 1.772	133,0 5.236	14,0 0.551	140°	TiAIN	IT9
SD1108A-1300-119-14R1 SD_DRILL_13.0MM_8XD_A		03295068	13,0 0.512	119,0 4.685	182,0 7.165	137,0 5.394	45,0 1.772	133,0 5.236	14,0 0.551	140°	TiAIN	IT9
SD1108A-1349-119-14R1 SD_DRILL_17/32_8XD_A		03323702	13,494 0.531	119,0 4.685	182,0 7.165	137,0 5.394	45,0 1.772	133,0 5.236	14,0 0.551	140°	TiAIN	IT9
SD1108A-1350-119-14R1 SD_DRILL_13.5MM_8XD_A		03295069	13,5 0.531	119,0 4.685	182,0 7.165	137,0 5.394	45,0 1.772	133,0 5.236	14,0 0.551	140°	TiAIN	IT9
SD1108A-1400-119-14R1 SD_DRILL_14.0MM_8XD_A		03295070	14,0 0.551	119,0 4.685	182,0 7.165	137,0 5.394	45,0 1.772	133,0 5.236	14,0 0.551	140°	TiAIN	IT9
Allegato		SD1108A-1429-136-16R1 SD_DRILL_9/16_8XD_A	03295071	14,288 0.563	136,0 5.354	204,0 8.031	156,0 6.142	48,0 1.890	152,0 5.984	16,0 0.630	140°	TiAIN
	SD1108A-1450-136-16R1 SD_DRILL_14.5MM_8XD_A	03295072	14,5 0.571	136,0 5.354	204,0 8.031	156,0 6.142	48,0 1.890	152,0 5.984	16,0 0.630	140°	TiAIN	IT9
	SD1108A-1500-136-16R1 SD_DRILL_15.0MM_8XD_A	03295073	15,0 0.591	136,0 5.354	204,0 8.031	156,0 6.142	48,0 1.890	152,0 5.984	16,0 0.630	140°	TiAIN	IT9
	SD1108A-1550-136-16R1 SD_DRILL_15.5MM_8XD_A	03295074	15,5 0.610	136,0 5.354	204,0 8.031	156,0 6.142	48,0 1.890	152,0 5.984	16,0 0.630	140°	TiAIN	IT9

Codice di ordinazione	Codice prodotto	DC	LU	OAL	LFS	LS	LCF	DMM	Angolo di punta	Rivestimento	Tolleranza foro
		mm <i>Inch</i>	mm <i>Inch</i>	mm <i>Inch</i>	mm <i>Inch</i>	mm <i>Inch</i>	mm <i>Inch</i>	mm <i>Inch</i>			
SD1108A-1588-136-16R1 <i>SD_DRILL_5/8_8XD_A</i>	03295075	15,875 <i>0.625</i>	136,0 <i>5.354</i>	204,0 <i>8.031</i>	156,0 <i>6.142</i>	48,0 <i>1.890</i>	152,0 <i>5.984</i>	16,0 <i>0.630</i>	140°	TiAIN	IT9
SD1108A-1600-136-16R1 <i>SD_DRILL_16.0MM_8XD_A</i>	03295076	16,0 <i>0.630</i>	136,0 <i>5.354</i>	204,0 <i>8.031</i>	156,0 <i>6.142</i>	48,0 <i>1.890</i>	152,0 <i>5.984</i>	16,0 <i>0.630</i>	140°	TiAIN	IT9
SD1108A-1650-153-18R1 <i>SD_DRILL_16.5MM_8XD_A</i>	03295077	16,5 <i>0.650</i>	153,0 <i>6.024</i>	223,0 <i>8.780</i>	175,0 <i>6.890</i>	48,0 <i>1.890</i>	171,0 <i>6.732</i>	18,0 <i>0.709</i>	140°	TiAIN	IT9
SD1108A-1700-153-18R1 <i>SD_DRILL_17.0MM_8XD_A</i>	03295078	17,0 <i>0.669</i>	153,0 <i>6.024</i>	223,0 <i>8.780</i>	175,0 <i>6.890</i>	48,0 <i>1.890</i>	171,0 <i>6.732</i>	18,0 <i>0.709</i>	140°	TiAIN	IT9
SD1108A-1750-153-18R1 <i>SD_DRILL_17.5MM_8XD_A</i>	03295079	17,5 <i>0.689</i>	153,0 <i>6.024</i>	223,0 <i>8.780</i>	175,0 <i>6.890</i>	48,0 <i>1.890</i>	171,0 <i>6.732</i>	18,0 <i>0.709</i>	140°	TiAIN	IT9
SD1108A-1800-153-18R1 <i>SD_DRILL_18.0MM_8XD_A</i>	03295080	18,0 <i>0.709</i>	153,0 <i>6.024</i>	223,0 <i>8.780</i>	175,0 <i>6.890</i>	48,0 <i>1.890</i>	171,0 <i>6.732</i>	18,0 <i>0.709</i>	140°	TiAIN	IT9
SD1108A-1850-170-20R1 <i>SD_DRILL_18.5MM_8XD_A</i>	03295081	18,5 <i>0.728</i>	170,0 <i>6.693</i>	244,0 <i>9.606</i>	194,0 <i>7.638</i>	50,0 <i>1.969</i>	190,0 <i>7.480</i>	20,0 <i>0.787</i>	140°	TiAIN	IT9
SD1108A-1900-170-20R1 <i>SD_DRILL_19.0MM_8XD_A</i>	03295082	19,0 <i>0.748</i>	170,0 <i>6.693</i>	244,0 <i>9.606</i>	194,0 <i>7.638</i>	50,0 <i>1.969</i>	190,0 <i>7.480</i>	20,0 <i>0.787</i>	140°	TiAIN	IT9
SD1108A-1905-170-20R1 <i>SD_DRILL_3/4_8XD_A</i>	03323703	19,05 <i>0.750</i>	170,0 <i>6.693</i>	244,0 <i>9.606</i>	194,0 <i>7.638</i>	50,0 <i>1.969</i>	190,0 <i>7.480</i>	20,0 <i>0.787</i>	140°	TiAIN	IT9
SD1108A-1950-170-20R1 <i>SD_DRILL_19.5MM_8XD_A</i>	03295083	19,5 <i>0.768</i>	170,0 <i>6.693</i>	244,0 <i>9.606</i>	194,0 <i>7.638</i>	50,0 <i>1.969</i>	190,0 <i>7.480</i>	20,0 <i>0.787</i>	140°	TiAIN	IT9
SD1108A-2000-170-20R1 <i>SD_DRILL_20.0MM_8XD_A</i>	03295084	20,0 <i>0.787</i>	170,0 <i>6.693</i>	244,0 <i>9.606</i>	194,0 <i>7.638</i>	50,0 <i>1.969</i>	190,0 <i>7.480</i>	20,0 <i>0.787</i>	140°	TiAIN	IT9

Introduzione

Foratura

Alesatura

Barenatura

Allegato

SD1112A

Profondità di foratura ~ 12 x D – Misure metriche/Pollici

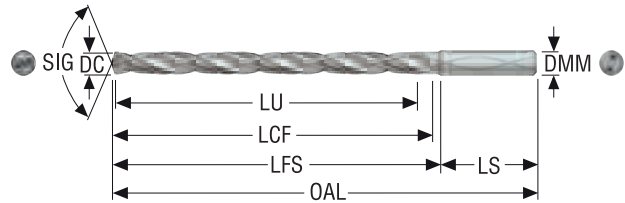

- Codolo cilindrico DIN 6537A
- Tolleranza DC m7
- Adduzione refrigerante interna
- Per i parametri di taglio raccomandati, vedere pagina(e) 144
- Per i diametri intermedi, utilizzare MyDesign.

Codice di ordinazione	Codice prodotto	DC	LU	OAL	LFS	LS	LCF	DMM	Angolo di punta	Rivestimento	Tolleranza foro
		mm Inch	mm Inch	mm Inch	mm Inch	mm Inch	mm Inch	mm Inch			
SD1112A-0300-048-06R1 SD_DRILL_3.0MM_12XD_A	03295085	3,0 0.118	48,0 1.890	92,0 3.622	56,0 2.205	36,0 1.417	54,0 2.126	6,0 0.236	140°	TiAIN	IT9
SD1112A-0310-048-06R1 SD_DRILL_3.1MM_12XD_A	03295086	3,1 0.122	48,0 1.890	92,0 3.622	56,0 2.205	36,0 1.417	54,0 2.126	6,0 0.236	140°	TiAIN	IT9
SD1112A-0318-048-06R1 SD_DRILL_1/8_12XD_A	03323704	3,175 0.125	48,0 1.890	92,0 3.622	56,0 2.205	36,0 1.417	54,0 2.126	6,0 0.236	140°	TiAIN	IT9
SD1112A-0320-048-06R1 SD_DRILL_3.2MM_12XD_A	03295087	3,2 0.126	48,0 1.890	92,0 3.622	56,0 2.205	36,0 1.417	54,0 2.126	6,0 0.236	140°	TiAIN	IT9
SD1112A-0330-048-06R1 SD_DRILL_3.3MM_12XD_A	03295088	3,3 0.130	48,0 1.890	92,0 3.622	56,0 2.205	36,0 1.417	54,0 2.126	6,0 0.236	140°	TiAIN	IT9
SD1112A-0340-048-06R1 SD_DRILL_3.4MM_12XD_A	03295089	3,4 0.134	48,0 1.890	92,0 3.622	56,0 2.205	36,0 1.417	54,0 2.126	6,0 0.236	140°	TiAIN	IT9
SD1112A-0350-048-06R1 SD_DRILL_3.5MM_12XD_A	03295090	3,5 0.138	48,0 1.890	92,0 3.622	56,0 2.205	36,0 1.417	54,0 2.126	6,0 0.236	140°	TiAIN	IT9
SD1112A-0357-048-06R1 SD_DRILL_9/64_12XD_A	03323705	3,572 0.141	48,0 1.890	92,0 3.622	56,0 2.205	36,0 1.417	54,0 2.126	6,0 0.236	140°	TiAIN	IT9
SD1112A-0360-048-06R1 SD_DRILL_3.6MM_12XD_A	03295091	3,6 0.142	48,0 1.890	92,0 3.622	56,0 2.205	36,0 1.417	54,0 2.126	6,0 0.236	140°	TiAIN	IT9
SD1112A-0370-048-06R1 SD_DRILL_3.7MM_12XD_A	03295092	3,7 0.146	48,0 1.890	92,0 3.622	56,0 2.205	36,0 1.417	54,0 2.126	6,0 0.236	140°	TiAIN	IT9
SD1112A-0380-056-06R1 SD_DRILL_3.8MM_12XD_A	03295093	3,8 0.150	56,0 2.205	102,0 4.016	66,0 2.598	36,0 1.417	64,0 2.520	6,0 0.236	140°	TiAIN	IT9
SD1112A-0390-056-06R1 SD_DRILL_3.9MM_12XD_A	03295094	3,9 0.154	56,0 2.205	102,0 4.016	66,0 2.598	36,0 1.417	64,0 2.520	6,0 0.236	140°	TiAIN	IT9
SD1112A-0397-056-06R1 SD_DRILL_5/32_12XD_A	03323706	3,969 0.156	56,0 2.205	102,0 4.016	66,0 2.598	36,0 1.417	64,0 2.520	6,0 0.236	140°	TiAIN	IT9
SD1112A-0400-056-06R1 SD_DRILL_4.0MM_12XD_A	03295095	4,0 0.157	56,0 2.205	102,0 4.016	66,0 2.598	36,0 1.417	64,0 2.520	6,0 0.236	140°	TiAIN	IT9
SD1112A-0410-056-06R1 SD_DRILL_4.1MM_12XD_A	03295096	4,1 0.161	56,0 2.205	102,0 4.016	66,0 2.598	36,0 1.417	64,0 2.520	6,0 0.236	140°	TiAIN	IT9
SD1112A-0420-056-06R1 SD_DRILL_4.2MM_12XD_A	03295097	4,2 0.165	56,0 2.205	102,0 4.016	66,0 2.598	36,0 1.417	64,0 2.520	6,0 0.236	140°	TiAIN	IT9
SD1112A-0430-056-06R1 SD_DRILL_4.3MM_12XD_A	03295098	4,3 0.169	56,0 2.205	102,0 4.016	66,0 2.598	36,0 1.417	64,0 2.520	6,0 0.236	140°	TiAIN	IT9
SD1112A-0437-056-06R1 SD_DRILL_11/64_12XD_A	03323707	4,366 0.172	56,0 2.205	102,0 4.016	66,0 2.598	36,0 1.417	64,0 2.520	6,0 0.236	140°	TiAIN	IT9
SD1112A-0440-056-06R1 SD_DRILL_4.4MM_12XD_A	03295099	4,4 0.173	56,0 2.205	102,0 4.016	66,0 2.598	36,0 1.417	64,0 2.520	6,0 0.236	140°	TiAIN	IT9
SD1112A-0450-056-06R1 SD_DRILL_4.5MM_12XD_A	03295100	4,5 0.177	56,0 2.205	102,0 4.016	66,0 2.598	36,0 1.417	64,0 2.520	6,0 0.236	140°	TiAIN	IT9
SD1112A-0460-056-06R1 SD_DRILL_4.6MM_12XD_A	03295101	4,6 0.181	56,0 2.205	102,0 4.016	66,0 2.598	36,0 1.417	64,0 2.520	6,0 0.236	140°	TiAIN	IT9

Introduzione

Foratura

Alesatura

Barenatura

Allegato

Codice di ordinazione	Codice prodotto	DC	LU	OAL	LFS	LS	LCF	DMM	Angolo di punta	Rivestimento	Tolleranza foro
		mm Inch	mm Inch	mm Inch	mm Inch	mm Inch	mm Inch	mm Inch			
SD1112A-0470-056-06R1 SD_DRILL_4.7MM_12XD_A	03295102	4,7 0.185	56,0 2.205	102,0 4.016	66,0 2.598	36,0 1.417	64,0 2.520	6,0 0.236	140°	TiAIN	IT9
SD1112A-0476-074-06R1 SD_DRILL_3/16_12XD_A	03323708	4,763 0.188	74,0 2.913	121,0 4.764	85,0 3.346	36,0 1.417	83,0 3.268	6,0 0.236	140°	TiAIN	IT9
SD1112A-0480-074-06R1 SD_DRILL_4.8MM_12XD_A	03295103	4,8 0.189	74,0 2.913	121,0 4.764	85,0 3.346	36,0 1.417	83,0 3.268	6,0 0.236	140°	TiAIN	IT9
SD1112A-0490-074-06R1 SD_DRILL_4.9MM_12XD_A	03295104	4,9 0.193	74,0 2.913	121,0 4.764	85,0 3.346	36,0 1.417	83,0 3.268	6,0 0.236	140°	TiAIN	IT9
SD1112A-0500-074-06R1 SD_DRILL_5.0MM_12XD_A	03295105	5,0 0.197	74,0 2.913	121,0 4.764	85,0 3.346	36,0 1.417	83,0 3.268	6,0 0.236	140°	TiAIN	IT9
SD1112A-0510-074-06R1 SD_DRILL_5.1MM_12XD_A	03295106	5,1 0.201	74,0 2.913	121,0 4.764	85,0 3.346	36,0 1.417	83,0 3.268	6,0 0.236	140°	TiAIN	IT9
SD1112A-0516-074-06R1 SD_DRILL_13/64_12XD_A	03323709	5,159 0.203	74,0 2.913	121,0 4.764	85,0 3.346	36,0 1.417	83,0 3.268	6,0 0.236	140°	TiAIN	IT9
SD1112A-0520-074-06R1 SD_DRILL_5.2MM_12XD_A	03295107	5,2 0.205	74,0 2.913	121,0 4.764	85,0 3.346	36,0 1.417	83,0 3.268	6,0 0.236	140°	TiAIN	IT9
SD1112A-0530-074-06R1 SD_DRILL_5.3MM_12XD_A	03295108	5,3 0.209	74,0 2.913	121,0 4.764	85,0 3.346	36,0 1.417	83,0 3.268	6,0 0.236	140°	TiAIN	IT9
SD1112A-0540-074-06R1 SD_DRILL_5.4MM_12XD_A	03295109	5,4 0.213	74,0 2.913	121,0 4.764	85,0 3.346	36,0 1.417	83,0 3.268	6,0 0.236	140°	TiAIN	IT9
SD1112A-0550-074-06R1 SD_DRILL_5.5MM_12XD_A	03295110	5,5 0.217	74,0 2.913	121,0 4.764	85,0 3.346	36,0 1.417	83,0 3.268	6,0 0.236	140°	TiAIN	IT9
SD1112A-0556-074-06R1 SD_DRILL_7/32_12XD_A	03295111	5,556 0.219	74,0 2.913	121,0 4.764	85,0 3.346	36,0 1.417	83,0 3.268	6,0 0.236	140°	TiAIN	IT9
SD1112A-0560-074-06R1 SD_DRILL_5.6MM_12XD_A	03295112	5,6 0.220	74,0 2.913	121,0 4.764	85,0 3.346	36,0 1.417	83,0 3.268	6,0 0.236	140°	TiAIN	IT9
SD1112A-0570-074-06R1 SD_DRILL_5.7MM_12XD_A	03295113	5,7 0.224	74,0 2.913	121,0 4.764	85,0 3.346	36,0 1.417	83,0 3.268	6,0 0.236	140°	TiAIN	IT9
SD1112A-0580-074-06R1 SD_DRILL_5.8MM_12XD_A	03295114	5,8 0.228	74,0 2.913	121,0 4.764	85,0 3.346	36,0 1.417	83,0 3.268	6,0 0.236	140°	TiAIN	IT9
SD1112A-0590-074-06R1 SD_DRILL_5.9MM_12XD_A	03295115	5,9 0.232	74,0 2.913	121,0 4.764	85,0 3.346	36,0 1.417	83,0 3.268	6,0 0.236	140°	TiAIN	IT9
SD1112A-0600-074-06R1 SD_DRILL_6.0MM_12XD_A	03295116	6,0 0.236	74,0 2.913	121,0 4.764	85,0 3.346	36,0 1.417	83,0 3.268	6,0 0.236	140°	TiAIN	IT9
SD1112A-0610-098-08R1 SD_DRILL_6.1MM_12XD_A	03295117	6,1 0.240	98,0 3.858	148,0 5.827	112,0 4.409	36,0 1.417	110,0 4.331	8,0 0.315	140°	TiAIN	IT9
SD1112A-0620-098-08R1 SD_DRILL_6.2MM_12XD_A	03295118	6,2 0.244	98,0 3.858	148,0 5.827	112,0 4.409	36,0 1.417	110,0 4.331	8,0 0.315	140°	TiAIN	IT9
SD1112A-0630-098-08R1 SD_DRILL_6.3MM_12XD_A	03295119	6,3 0.248	98,0 3.858	148,0 5.827	112,0 4.409	36,0 1.417	110,0 4.331	8,0 0.315	140°	TiAIN	IT9
SD1112A-0635-098-08R1 SD_DRILL_1/4_12XD_A	03295120	6,35 0.250	98,0 3.858	148,0 5.827	112,0 4.409	36,0 1.417	110,0 4.331	8,0 0.315	140°	TiAIN	IT9
SD1112A-0640-098-08R1 SD_DRILL_6.4MM_12XD_A	03295121	6,4 0.252	98,0 3.858	148,0 5.827	112,0 4.409	36,0 1.417	110,0 4.331	8,0 0.315	140°	TiAIN	IT9
SD1112A-0650-098-08R1 SD_DRILL_6.5MM_12XD_A	03295122	6,5 0.256	98,0 3.858	148,0 5.827	112,0 4.409	36,0 1.417	110,0 4.331	8,0 0.315	140°	TiAIN	IT9
SD1112A-0660-098-08R1 SD_DRILL_6.6MM_12XD_A	03295123	6,6 0.260	98,0 3.858	148,0 5.827	112,0 4.409	36,0 1.417	110,0 4.331	8,0 0.315	140°	TiAIN	IT9
SD1112A-0670-098-08R1 SD_DRILL_6.7MM_12XD_A	03295124	6,7 0.264	98,0 3.858	148,0 5.827	112,0 4.409	36,0 1.417	110,0 4.331	8,0 0.315	140°	TiAIN	IT9
SD1112A-0675-098-08R1 SD_DRILL_17/64_12XD_A	03323710	6,747 0.266	98,0 3.858	148,0 5.827	128,0 5.039	36,0 1.417	110,0 4.331	8,0 0.315	140°	TiAIN	IT9
SD1112A-0680-098-08R1 SD_DRILL_6.8MM_12XD_A	03295125	6,8 0.268	98,0 3.858	148,0 5.827	112,0 4.409	36,0 1.417	110,0 4.331	8,0 0.315	140°	TiAIN	IT9
SD1112A-0690-098-08R1 SD_DRILL_6.9MM_12XD_A	03295126	6,9 0.272	98,0 3.858	148,0 5.827	112,0 4.409	36,0 1.417	110,0 4.331	8,0 0.315	140°	TiAIN	IT9
SD1112A-0700-098-08R1 SD_DRILL_7.0MM_12XD_A	03295127	7,0 0.276	98,0 3.858	148,0 5.827	112,0 4.409	36,0 1.417	110,0 4.331	8,0 0.315	140°	TiAIN	IT9
SD1112A-0710-098-08R1 SD_DRILL_7.1MM_12XD_A	03295128	7,1 0.280	98,0 3.858	148,0 5.827	112,0 4.409	36,0 1.417	110,0 4.331	8,0 0.315	140°	TiAIN	IT9
SD1112A-0714-098-08R1 SD_DRILL_9/32_12XD_A	03323711	7,144 0.281	98,0 3.858	148,0 5.827	128,0 5.039	36,0 1.417	110,0 4.331	8,0 0.315	140°	TiAIN	IT9

Introduzione

Foratura

Alesatura

Barenatura

Allegato

Codice di ordinazione	Codice prodotto	DC	LU	OAL	LFS	LS	LCF	DMM	Angolo di punta	Rivestimento	Tolleranza foro
		mm Inch	mm Inch	mm Inch	mm Inch	mm Inch	mm Inch	mm Inch			
SD1112A-0730-098-08R1 SD_DRILL_7.3MM_12XD_A	03323712	7,3 0.287	98,0 3.858	148,0 5.827	128,0 5.039	36,0 1.417	110,0 4.331	8,0 0.315	140°	TiAIN	IT9
SD1112A-0740-098-08R1 SD_DRILL_7.4MM_12XD_A	03295129	7,4 0.291	98,0 3.858	148,0 5.827	112,0 4.409	36,0 1.417	110,0 4.331	8,0 0.315	140°	TiAIN	IT9
SD1112A-0750-098-08R1 SD_DRILL_7.5MM_12XD_A	03295130	7,5 0.295	98,0 3.858	148,0 5.827	112,0 4.409	36,0 1.417	110,0 4.331	8,0 0.315	140°	TiAIN	IT9
SD1112A-0754-098-08R1 SD_DRILL_19/64_12XD_A	03323713	7,541 0.297	98,0 3.858	148,0 5.827	128,0 5.039	36,0 1.417	110,0 4.331	8,0 0.315	140°	TiAIN	IT9
SD1112A-0780-098-08R1 SD_DRILL_7.8MM_12XD_A	03295131	7,8 0.307	98,0 3.858	148,0 5.827	112,0 4.409	36,0 1.417	110,0 4.331	8,0 0.315	140°	TiAIN	IT9
SD1112A-0790-098-08R1 SD_DRILL_7.9MM_12XD_A	03295132	7,9 0.311	98,0 3.858	148,0 5.827	112,0 4.409	36,0 1.417	110,0 4.331	8,0 0.315	140°	TiAIN	IT9
SD1112A-0794-098-08R1 SD_DRILL_5/16_12XD_A	03323714	7,938 0.313	98,0 3.858	148,0 5.827	128,0 5.039	36,0 1.417	110,0 4.331	8,0 0.315	140°	TiAIN	IT9
SD1112A-0800-098-08R1 SD_DRILL_8.0MM_12XD_A	03295133	8,0 0.315	98,0 3.858	148,0 5.827	112,0 4.409	36,0 1.417	110,0 4.331	8,0 0.315	140°	TiAIN	IT9
SD1112A-0810-123-10R1 SD_DRILL_8.1MM_12XD_A	03295135	8,1 0.319	123,0 4.843	180,0 7.087	140,0 5.512	40,0 1.575	138,0 5.433	10,0 0.394	140°	TiAIN	IT9
SD1112A-0820-123-10R1 SD_DRILL_8.2MM_12XD_A	03295136	8,2 0.323	123,0 4.843	180,0 7.087	140,0 5.512	40,0 1.575	138,0 5.433	10,0 0.394	140°	TiAIN	IT9
SD1112A-0830-123-10R1 SD_DRILL_8.3MM_12XD_A	03295137	8,3 0.327	123,0 4.843	180,0 7.087	140,0 5.512	40,0 1.575	138,0 5.433	10,0 0.394	140°	TiAIN	IT9
SD1112A-0840-123-10R1 SD_DRILL_8.4MM_12XD_A	03295138	8,4 0.331	123,0 4.843	180,0 7.087	140,0 5.512	40,0 1.575	138,0 5.433	10,0 0.394	140°	TiAIN	IT9
SD1112A-0850-123-10R1 SD_DRILL_8.5MM_12XD_A	03295139	8,5 0.335	123,0 4.843	180,0 7.087	140,0 5.512	40,0 1.575	138,0 5.433	10,0 0.394	140°	TiAIN	IT9
SD1112A-0860-123-10R1 SD_DRILL_8.6MM_12XD_A	03295140	8,6 0.339	123,0 4.843	180,0 7.087	140,0 5.512	40,0 1.575	138,0 5.433	10,0 0.394	140°	TiAIN	IT9
SD1112A-0870-123-10R1 SD_DRILL_8.7MM_12XD_A	03295141	8,7 0.343	123,0 4.843	180,0 7.087	140,0 5.512	40,0 1.575	138,0 5.433	10,0 0.394	140°	TiAIN	IT9
SD1112A-0873-123-10R1 SD_DRILL_11/32_12XD_A	03323715	8,731 0.344	123,0 4.843	180,0 7.087	140,0 5.512	40,0 1.575	138,0 5.433	10,0 0.394	140°	TiAIN	IT9
SD1112A-0880-123-10R1 SD_DRILL_8.8MM_12XD_A	03295142	8,8 0.346	123,0 4.843	180,0 7.087	140,0 5.512	40,0 1.575	138,0 5.433	10,0 0.394	140°	TiAIN	IT9
SD1112A-0900-123-10R1 SD_DRILL_9.0MM_12XD_A	03295143	9,0 0.354	123,0 4.843	180,0 7.087	140,0 5.512	40,0 1.575	138,0 5.433	10,0 0.394	140°	TiAIN	IT9
SD1112A-0913-123-10R1 SD_DRILL_23/64_12XD_A	03323716	9,128 0.359	123,0 4.843	180,0 7.087	140,0 5.512	40,0 1.575	138,0 5.433	10,0 0.394	140°	TiAIN	IT9
SD1112A-0930-123-10R1 SD_DRILL_9.3MM_12XD_A	03295144	9,3 0.366	123,0 4.843	180,0 7.087	140,0 5.512	40,0 1.575	138,0 5.433	10,0 0.394	140°	TiAIN	IT9
SD1112A-0950-123-10R1 SD_DRILL_9.5MM_12XD_A	03295145	9,5 0.374	123,0 4.843	180,0 7.087	140,0 5.512	40,0 1.575	138,0 5.433	10,0 0.394	140°	TiAIN	IT9
SD1112A-0953-123-10R1 SD_DRILL_3/8_12XD_A	03323717	9,525 0.375	123,0 4.843	180,0 7.087	140,0 5.512	40,0 1.575	138,0 5.433	10,0 0.394	140°	TiAIN	IT9
SD1112A-0970-123-10R1 SD_DRILL_9.7MM_12XD_A	03295146	9,7 0.382	123,0 4.843	180,0 7.087	140,0 5.512	40,0 1.575	138,0 5.433	10,0 0.394	140°	TiAIN	IT9
SD1112A-0980-123-10R1 SD_DRILL_9.8MM_12XD_A	03295147	9,8 0.386	123,0 4.843	180,0 7.087	140,0 5.512	40,0 1.575	138,0 5.433	10,0 0.394	140°	TiAIN	IT9
SD1112A-0992-123-10R1 SD_DRILL_25/64_12XD_A	03323718	9,922 0.391	123,0 4.843	180,0 7.087	140,0 5.512	40,0 1.575	138,0 5.433	10,0 0.394	140°	TiAIN	IT9
SD1112A-1000-123-10R1 SD_DRILL_10.0MM_12XD_A	03295148	10,0 0.394	123,0 4.843	180,0 7.087	140,0 5.512	40,0 1.575	138,0 5.433	10,0 0.394	140°	TiAIN	IT9
SD1112A-1020-140-12R1 SD_DRILL_10.2MM_12XD_A	03295149	10,2 0.402	140,0 5.512	206,0 8.110	161,0 6.339	45,0 1.772	158,0 6.220	12,0 0.472	140°	TiAIN	IT9
SD1112A-1030-140-12R1 SD_DRILL_10.3MM_12XD_A	03295150	10,3 0.406	140,0 5.512	206,0 8.110	161,0 6.339	45,0 1.772	158,0 6.220	12,0 0.472	140°	TiAIN	IT9
SD1112A-1032-140-12R1 SD_DRILL_13/32_12XD_A	03323719	10,319 0.406	140,0 5.512	206,0 8.110	161,0 6.339	45,0 1.772	158,0 6.220	12,0 0.472	140°	TiAIN	IT9
SD1112A-1050-140-12R1 SD_DRILL_10.5MM_12XD_A	03295151	10,5 0.413	140,0 5.512	206,0 8.110	161,0 6.339	45,0 1.772	158,0 6.220	12,0 0.472	140°	TiAIN	IT9
SD1112A-1072-140-12R1 SD_DRILL_27/64_12XD_A	03323720	10,716 0.422	140,0 5.512	206,0 8.110	161,0 6.339	45,0 1.772	158,0 6.220	12,0 0.472	140°	TiAIN	IT9

Codice di ordinazione	Codice prodotto	DC	LU	OAL	LFS	LS	LCF	DMM	Angolo di punta	Rivesti-mento	Tolleranza foro
		mm <i>Inch</i>	mm <i>Inch</i>	mm <i>Inch</i>	mm <i>Inch</i>	mm <i>Inch</i>	mm <i>Inch</i>	mm <i>Inch</i>			
SD1112A-1080-140-12R1 SD_DRILL_10.8MM_12XD_A	03295152	10,8 0.425	140,0 5.512	206,0 8.110	161,0 6.339	45,0 1.772	158,0 6.220	12,0 0.472	140°	TiAIN	IT9
SD1112A-1100-140-12R1 SD_DRILL_11.0MM_12XD_A	03295153	11,0 0.433	140,0 5.512	206,0 8.110	161,0 6.339	45,0 1.772	158,0 6.220	12,0 0.472	140°	TiAIN	IT9
SD1112A-1111-140-12R1 SD_DRILL_7/16_12XD_A	03323722	11,113 0.438	140,0 5.512	206,0 8.110	161,0 6.339	45,0 1.772	158,0 6.220	12,0 0.472	140°	TiAIN	IT9
SD1112A-1120-140-12R1 SD_DRILL_11.2MM_12XD_A	03295154	11,2 0.441	140,0 5.512	206,0 8.110	161,0 6.339	45,0 1.772	158,0 6.220	12,0 0.472	140°	TiAIN	IT9
SD1112A-1150-140-12R1 SD_DRILL_11.5MM_12XD_A	03295155	11,5 0.453	140,0 5.512	206,0 8.110	161,0 6.339	45,0 1.772	158,0 6.220	12,0 0.472	140°	TiAIN	IT9
SD1112A-1170-140-12R1 SD_DRILL_11.7MM_12XD_A	03295156	11,7 0.461	140,0 5.512	206,0 8.110	161,0 6.339	45,0 1.772	158,0 6.220	12,0 0.472	140°	TiAIN	IT9
SD1112A-1180-140-12R1 SD_DRILL_11.8MM_12XD_A	03295157	11,8 0.465	140,0 5.512	206,0 8.110	161,0 6.339	45,0 1.772	158,0 6.220	12,0 0.472	140°	TiAIN	IT9
SD1112A-1191-140-12R1 SD_DRILL_15/32_12XD_A	03323723	11,906 0.469	140,0 5.512	206,0 8.110	161,0 6.339	45,0 1.772	158,0 6.220	12,0 0.472	140°	TiAIN	IT9
SD1112A-1200-140-12R1 SD_DRILL_12.0MM_12XD_A	03295158	12,0 0.472	140,0 5.512	206,0 8.110	161,0 6.339	45,0 1.772	158,0 6.220	12,0 0.472	140°	TiAIN	IT9
SD1112A-1220-168-14R1 SD_DRILL_12.2MM_12XD_A	03295159	12,2 0.480	168,0 6.614	230,0 9.055	185,0 7.283	45,0 1.772	182,0 7.165	14,0 0.551	140°	TiAIN	IT9
SD1112A-1230-168-14R1 SD_DRILL_31/64_12XD_A	03295160	12,3 0.484	168,0 6.614	230,0 9.055	185,0 7.283	45,0 1.772	182,0 7.165	14,0 0.551	140°	TiAIN	IT9
SD1112A-1250-168-14R1 SD_DRILL_12.5MM_12XD_A	03295161	12,5 0.492	168,0 6.614	230,0 9.055	185,0 7.283	45,0 1.772	182,0 7.165	14,0 0.551	140°	TiAIN	IT9
SD1112A-1270-168-14R1 SD_DRILL_1/2_12XD_A	03295162	12,7 0.500	168,0 6.614	230,0 9.055	185,0 7.283	45,0 1.772	182,0 7.165	14,0 0.551	140°	TiAIN	IT9
SD1112A-1300-168-14R1 SD_DRILL_13.0MM_12XD_A	03295163	13,0 0.512	168,0 6.614	230,0 9.055	185,0 7.283	45,0 1.772	182,0 7.165	14,0 0.551	140°	TiAIN	IT9
SD1112A-1349-168-14R1 SD_DRILL_17/32_12XD_A	03323724	13,494 0.531	168,0 6.614	230,0 9.055	185,0 7.283	45,0 1.772	182,0 7.165	14,0 0.551	140°	TiAIN	IT9
SD1112A-1350-168-14R1 SD_DRILL_13.5MM_12XD_A	03295164	13,5 0.531	168,0 6.614	230,0 9.055	185,0 7.283	45,0 1.772	182,0 7.165	14,0 0.551	140°	TiAIN	IT9
SD1112A-1400-168-14R1 SD_DRILL_14.0MM_12XD_A	03295165	14,0 0.551	168,0 6.614	230,0 9.055	185,0 7.283	45,0 1.772	182,0 7.165	14,0 0.551	140°	TiAIN	IT9
SD1112A-1429-192-16R1 SD_DRILL_9/16_12XD_A	03295166	14,288 0.563	192,0 7.559	260,0 10.236	212,0 8.346	48,0 1.890	208,0 8.189	16,0 0.630	140°	TiAIN	IT9
SD1112A-1450-192-16R1 SD_DRILL_14.5MM_12XD_A	03295167	14,5 0.571	192,0 7.559	260,0 10.236	212,0 8.346	48,0 1.890	208,0 8.189	16,0 0.630	140°	TiAIN	IT9
SD1112A-1500-192-16R1 SD_DRILL_15.0MM_12XD_A	03295168	15,0 0.591	192,0 7.559	260,0 10.236	212,0 8.346	48,0 1.890	208,0 8.189	16,0 0.630	140°	TiAIN	IT9
SD1112A-1550-192-16R1 SD_DRILL_15.5MM_12XD_A	03295169	15,5 0.610	192,0 7.559	260,0 10.236	212,0 8.346	48,0 1.890	208,0 8.189	16,0 0.630	140°	TiAIN	IT9
SD1112A-1588-192-16R1 SD_DRILL_5/8_12XD_A	03295170	15,875 0.625	192,0 7.559	260,0 10.236	212,0 8.346	48,0 1.890	208,0 8.189	16,0 0.630	140°	TiAIN	IT9
SD1112A-1600-192-16R1 SD_DRILL_16.0MM_12XD_A	03295171	16,0 0.630	192,0 7.559	260,0 10.236	212,0 8.346	48,0 1.890	208,0 8.189	16,0 0.630	140°	TiAIN	IT9
SD1112A-1650-216-18R1 SD_DRILL_16.5MM_12XD_A	03295172	16,5 0.650	216,0 8.504	285,0 11.220	237,0 9.331	48,0 1.890	234,0 9.213	18,0 0.709	140°	TiAIN	IT9
SD1112A-1700-216-18R1 SD_DRILL_17.0MM_12XD_A	03295173	17,0 0.669	216,0 8.504	285,0 11.220	237,0 9.331	48,0 1.890	234,0 9.213	18,0 0.709	140°	TiAIN	IT9
SD1112A-1750-216-18R1 SD_DRILL_17.5MM_12XD_A	03295174	17,5 0.689	216,0 8.504	285,0 11.220	237,0 9.331	48,0 1.890	234,0 9.213	18,0 0.709	140°	TiAIN	IT9
SD1112A-1800-216-18R1 SD_DRILL_18.0MM_12XD_A	03295175	18,0 0.709	216,0 8.504	285,0 11.220	237,0 9.331	48,0 1.890	234,0 9.213	18,0 0.709	140°	TiAIN	IT9
SD1112A-1900-238-20R1 SD_DRILL_19.0MM_12XD_A	03295176	19,0 0.748	238,0 9.370	310,0 12.205	260,0 10.236	50,0 1.969	258,0 10.157	20,0 0.787	140°	TiAIN	IT9
SD1112A-2000-238-20R1 SD_DRILL_20.0MM_12XD_A	03295177	20,0 0.787	238,0 9.370	310,0 12.205	260,0 10.236	50,0 1.969	258,0 10.157	20,0 0.787	140°	TiAIN	IT9

Introduzione

Foratura

Alesatura

Barenatura

Allegato



Feedmax -P – punte a diametro singolo

Progettate per alta produttività e basso costo per foro, offrono una combinazione unica di metallo duro, rivestimenti e geometrie all'avanguardia.

- Geometria auto-centrante per fori di alta qualità senza necessità di operazioni di centratura.
- Uno speciale rivestimento TiAlN conferisce alle punte Seco Feedmax un'elevata resistenza al calore, una notevole robustezza del tagliente ed una durata prolungata ed affidabile.

SD203A-P

Profondità di foratura ~ 3 x D – Misure metriche/Pollici

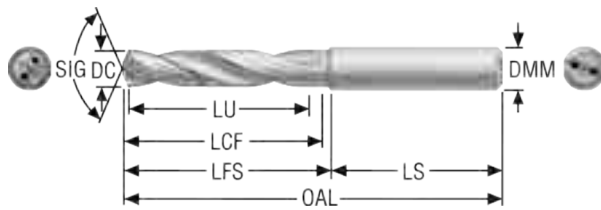

- Codolo cilindrico DIN 6537A
- Tolleranza DC m7
- Adduzione refrigerante interna
- Per i parametri di taglio raccomandati, vedere pagina(e) 145-146
- Per i diametri intermedi, utilizzare MyDesign.

Codice di ordinazione	Codice prodotto	DC	LU	OAL	LFS	LS	LCF	DMM	Angolo di punta	Rivestimento	Tolleranza foro
		mm Inch	mm Inch	mm Inch	mm Inch	mm Inch	mm Inch	mm Inch			
SD203A-0200-007-04R1-P	03045918	2,0 0.079	7,0 0.276	41,0 1.614	14,0 0.551	27,0 1.063	11,0 0.433	4,0 0.157	140°	TiAlN	IT8-9
SD203A-0210-007-04R1-P	03045919	2,1 0.083	7,0 0.276	41,0 1.614	14,0 0.551	27,0 1.063	11,0 0.433	4,0 0.157	140°	TiAlN	IT8-9
SD203A-0220-007-04R1-P	03045920	2,2 0.087	7,0 0.276	41,0 1.614	14,0 0.551	27,0 1.063	11,0 0.433	4,0 0.157	140°	TiAlN	IT8-9
SD203A-0230-008-04R1-P	03045921	2,3 0.091	8,0 0.315	44,0 1.732	17,0 0.669	27,0 1.063	12,5 0.492	4,0 0.157	140°	TiAlN	IT8-9
SD203A-0235-008-04R1-P	03138154	2,35 0.093	8,0 0.315	44,0 1.732	17,0 0.669	27,0 1.063	12,5 0.492	4,0 0.157	140°	TiAlN	IT8-9
SD203A-0238-008-04R1-P	03120476	2,381 0.094	8,0 0.315	44,0 1.732	17,0 0.669	27,0 1.063	12,5 0.492	4,0 0.157	140°	TiAlN	IT8-9
SD203A-0240-008-04R1-P	03045922	2,4 0.094	8,0 0.315	44,0 1.732	17,0 0.669	27,0 1.063	12,5 0.492	4,0 0.157	140°	TiAlN	IT8-9
SD203A-0250-008-04R1-P	03045923	2,5 0.098	8,0 0.315	44,0 1.732	17,0 0.669	27,0 1.063	12,5 0.492	4,0 0.157	140°	TiAlN	IT8-9
SD203A-0260-008-04R1-P	03045924	2,6 0.102	8,0 0.315	44,0 1.732	17,0 0.669	27,0 1.063	12,5 0.492	4,0 0.157	140°	TiAlN	IT8-9
SD203A-0270-009-04R1-P	03045925	2,7 0.106	9,0 0.354	44,0 1.732	17,0 0.669	27,0 1.063	14,5 0.571	4,0 0.157	140°	TiAlN	IT8-9
SD203A-0278-009-04R1-P	03120495	2,778 0.109	9,0 0.354	44,0 1.732	17,0 0.669	27,0 1.063	14,5 0.571	4,0 0.157	140°	TiAlN	IT8-9
SD203A-0280-009-04R1-P	03045926	2,8 0.110	9,0 0.354	44,0 1.732	17,0 0.669	27,0 1.063	14,5 0.571	4,0 0.157	140°	TiAlN	IT8-9
SD203A-0290-009-04R1-P	03045927	2,9 0.114	9,0 0.354	44,0 1.732	17,0 0.669	27,0 1.063	14,5 0.571	4,0 0.157	140°	TiAlN	IT8-9
SD203A-0300-014-06R1-P	03045928	3,0 0.118	14,0 0.551	62,0 2.441	26,0 1.024	36,0 1.417	20,0 0.787	6,0 0.236	140°	TiAlN	IT8-9
SD203A-0310-014-06R1-P	03045929	3,1 0.122	14,0 0.551	62,0 2.441	26,0 1.024	36,0 1.417	20,0 0.787	6,0 0.236	140°	TiAlN	IT8-9
SD203A-0318-014-06R1-P	03046061	3,175 0.125	14,0 0.551	62,0 2.441	26,0 1.024	36,0 1.417	20,0 0.787	6,0 0.236	140°	TiAlN	IT8-9
SD203A-0320-014-06R1-P	03045930	3,2 0.126	14,0 0.551	62,0 2.441	26,0 1.024	36,0 1.417	20,0 0.787	6,0 0.236	140°	TiAlN	IT8-9
SD203A-0325-014-06R1-P	03045931	3,25 0.128	14,0 0.551	62,0 2.441	26,0 1.024	36,0 1.417	20,0 0.787	6,0 0.236	140°	TiAlN	IT8-9
SD203A-0330-014-06R1-P	03045932	3,3 0.130	14,0 0.551	62,0 2.441	26,0 1.024	36,0 1.417	20,0 0.787	6,0 0.236	140°	TiAlN	IT8-9
SD203A-0340-014-06R1-P	03045933	3,4 0.134	14,0 0.551	62,0 2.441	26,0 1.024	36,0 1.417	20,0 0.787	6,0 0.236	140°	TiAlN	IT8-9
SD203A-0350-014-06R1-P	03045934	3,5 0.138	14,0 0.551	62,0 2.441	26,0 1.024	36,0 1.417	20,0 0.787	6,0 0.236	140°	TiAlN	IT8-9
SD203A-0357-014-06R1-P	03046062	3,572 0.141	14,0 0.551	62,0 2.441	26,0 1.024	36,0 1.417	20,0 0.787	6,0 0.236	140°	TiAlN	IT8-9

Codice di ordinazione	Codice prodotto	DC	LU	OAL	LFS	LS	LCF	DMM	Angolo di punta	Rivestimento	Tolleranza foro
		mm Inch	mm Inch	mm Inch	mm Inch	mm Inch	mm Inch	mm Inch			
SD203A-0360-014-06R1-P	03045935	3,6 0.142	14,0 0.551	62,0 2.441	26,0 1.024	36,0 1.417	20,0 0.787	6,0 0.236	140°	TiAIN	IT8-9
SD203A-0365-014-06R1-P	03045936	3,65 0.144	14,0 0.551	62,0 2.441	26,0 1.024	36,0 1.417	20,0 0.787	6,0 0.236	140°	TiAIN	IT8-9
SD203A-0370-014-06R1-P	03045937	3,7 0.146	14,0 0.551	62,0 2.441	26,0 1.024	36,0 1.417	20,0 0.787	6,0 0.236	140°	TiAIN	IT8-9
SD203A-0380-017-06R1-P	03045938	3,8 0.150	17,0 0.669	66,0 2.598	30,0 1.181	36,0 1.417	24,0 0.945	6,0 0.236	140°	TiAIN	IT8-9
SD203A-0390-017-06R1-P	03045939	3,9 0.154	17,0 0.669	66,0 2.598	30,0 1.181	36,0 1.417	24,0 0.945	6,0 0.236	140°	TiAIN	IT8-9
SD203A-0397-017-06R1-P	03046063	3,97 0.156	17,0 0.669	66,0 2.598	30,0 1.181	36,0 1.417	24,0 0.945	6,0 0.236	140°	TiAIN	IT8-9
SD203A-0400-017-06R1-P	03045940	4,0 0.157	17,0 0.669	66,0 2.598	30,0 1.181	36,0 1.417	24,0 0.945	6,0 0.236	140°	TiAIN	IT8-9
SD203A-0410-017-06R1-P	03045941	4,1 0.161	17,0 0.669	66,0 2.598	30,0 1.181	36,0 1.417	24,0 0.945	6,0 0.236	140°	TiAIN	IT8-9
SD203A-0420-017-06R1-P	03045942	4,2 0.165	17,0 0.669	66,0 2.598	30,0 1.181	36,0 1.417	24,0 0.945	6,0 0.236	140°	TiAIN	IT8-9
SD203A-0430-017-06R1-P	03045943	4,3 0.169	17,0 0.669	66,0 2.598	30,0 1.181	36,0 1.417	24,0 0.945	6,0 0.236	140°	TiAIN	IT8-9
SD203A-0437-017-06R1-P	03046064	4,366 0.172	17,0 0.669	66,0 2.598	30,0 1.181	36,0 1.417	24,0 0.945	6,0 0.236	140°	TiAIN	IT8-9
SD203A-0450-017-06R1-P	03045944	4,5 0.177	17,0 0.669	66,0 2.598	30,0 1.181	36,0 1.417	24,0 0.945	6,0 0.236	140°	TiAIN	IT8-9
SD203A-0460-017-06R1-P	03045945	4,6 0.181	17,0 0.669	66,0 2.598	30,0 1.181	36,0 1.417	24,0 0.945	6,0 0.236	140°	TiAIN	IT8-9
SD203A-0465-017-06R1-P	03045946	4,65 0.183	17,0 0.669	66,0 2.598	30,0 1.181	36,0 1.417	24,0 0.945	6,0 0.236	140°	TiAIN	IT8-9
SD203A-0470-017-06R1-P	03045947	4,7 0.185	17,0 0.669	66,0 2.598	30,0 1.181	36,0 1.417	24,0 0.945	6,0 0.236	140°	TiAIN	IT8-9
SD203A-0476-020-06R1-P	03046065	4,763 0.188	20,0 0.787	66,0 2.598	30,0 1.181	36,0 1.417	28,0 1.102	6,0 0.236	140°	TiAIN	IT8-9
SD203A-0480-020-06R1-P	03045948	4,8 0.189	20,0 0.787	66,0 2.598	30,0 1.181	36,0 1.417	28,0 1.102	6,0 0.236	140°	TiAIN	IT8-9
SD203A-0490-020-06R1-P	03045949	4,9 0.193	20,0 0.787	66,0 2.598	30,0 1.181	36,0 1.417	28,0 1.102	6,0 0.236	140°	TiAIN	IT8-9
SD203A-0500-020-06R1-P	03045950	5,0 0.197	20,0 0.787	66,0 2.598	30,0 1.181	36,0 1.417	28,0 1.102	6,0 0.236	140°	TiAIN	IT8-9
SD203A-0510-020-06R1-P	03045951	5,1 0.201	20,0 0.787	66,0 2.598	30,0 1.181	36,0 1.417	28,0 1.102	6,0 0.236	140°	TiAIN	IT8-9
SD203A-0516-020-06R1-P	03046066	5,159 0.203	20,0 0.787	66,0 2.598	30,0 1.181	36,0 1.417	28,0 1.102	6,0 0.236	140°	TiAIN	IT8-9
SD203A-0520-020-06R1-P	03045952	5,2 0.205	20,0 0.787	66,0 2.598	30,0 1.181	36,0 1.417	28,0 1.102	6,0 0.236	140°	TiAIN	IT8-9
SD203A-0530-020-06R1-P	03045953	5,3 0.209	20,0 0.787	66,0 2.598	30,0 1.181	36,0 1.417	28,0 1.102	6,0 0.236	140°	TiAIN	IT8-9
SD203A-0540-020-06R1-P	03045954	5,4 0.213	20,0 0.787	66,0 2.598	30,0 1.181	36,0 1.417	28,0 1.102	6,0 0.236	140°	TiAIN	IT8-9
SD203A-0550-020-06R1-P	03045955	5,5 0.217	20,0 0.787	66,0 2.598	30,0 1.181	36,0 1.417	28,0 1.102	6,0 0.236	140°	TiAIN	IT8-9
SD203A-0555-020-06R1-P	03045956	5,55 0.219	20,0 0.787	66,0 2.598	30,0 1.181	36,0 1.417	28,0 1.102	6,0 0.236	140°	TiAIN	IT8-9
SD203A-0556-020-06R1-P	03046067	5,556 0.219	20,0 0.787	66,0 2.598	30,0 1.181	36,0 1.417	28,0 1.102	6,0 0.236	140°	TiAIN	IT8-9
SD203A-0560-020-06R1-P	03045957	5,6 0.220	20,0 0.787	66,0 2.598	30,0 1.181	36,0 1.417	28,0 1.102	6,0 0.236	140°	TiAIN	IT8-9
SD203A-0570-020-06R1-P	03045958	5,7 0.224	20,0 0.787	66,0 2.598	30,0 1.181	36,0 1.417	28,0 1.102	6,0 0.236	140°	TiAIN	IT8-9
SD203A-0580-020-06R1-P	03045959	5,8 0.228	20,0 0.787	66,0 2.598	30,0 1.181	36,0 1.417	28,0 1.102	6,0 0.236	140°	TiAIN	IT8-9
SD203A-0590-020-06R1-P	03045960	5,9 0.232	20,0 0.787	66,0 2.598	30,0 1.181	36,0 1.417	28,0 1.102	6,0 0.236	140°	TiAIN	IT8-9

Codice di ordinazione	Codice prodotto	DC	LU	OAL	LFS	LS	LCF	DMM	Angolo di punta	Rivestimento	Tolleranza foro
		mm Inch	mm Inch	mm Inch	mm Inch	mm Inch	mm Inch	mm Inch			
SD203A-0595-020-06R1-P	03046068	5,953 0.234	20,0 0.787	66,0 2.598	30,0 1.181	36,0 1.417	28,0 1.102	6,0 0.236	140°	TiAIN	IT8-9
SD203A-0600-020-06R1-P	03045961	6,0 0.236	20,0 0.787	66,0 2.598	30,0 1.181	36,0 1.417	28,0 1.102	6,0 0.236	140°	TiAIN	IT8-9
SD203A-0610-024-08R1-P	03045962	6,1 0.240	24,0 0.945	79,0 3.110	43,0 1.693	36,0 1.417	34,0 1.339	8,0 0.315	140°	TiAIN	IT8-9
SD203A-0620-024-08R1-P	03045963	6,2 0.244	24,0 0.945	79,0 3.110	43,0 1.693	36,0 1.417	34,0 1.339	8,0 0.315	140°	TiAIN	IT8-9
SD203A-0630-024-08R1-P	03045964	6,3 0.248	24,0 0.945	79,0 3.110	43,0 1.693	36,0 1.417	34,0 1.339	8,0 0.315	140°	TiAIN	IT8-9
SD203A-0635-024-08R1-P	03046069	6,35 0.250	24,0 0.945	79,0 3.110	43,0 1.693	36,0 1.417	34,0 1.339	8,0 0.315	140°	TiAIN	IT8-9
SD203A-0640-024-08R1-P	03045965	6,4 0.252	24,0 0.945	79,0 3.110	43,0 1.693	36,0 1.417	34,0 1.339	8,0 0.315	140°	TiAIN	IT8-9
SD203A-0650-024-08R1-P	03045966	6,5 0.256	24,0 0.945	79,0 3.110	43,0 1.693	36,0 1.417	34,0 1.339	8,0 0.315	140°	TiAIN	IT8-9
SD203A-0660-024-08R1-P	03045967	6,6 0.260	24,0 0.945	79,0 3.110	43,0 1.693	36,0 1.417	34,0 1.339	8,0 0.315	140°	TiAIN	IT8-9
SD203A-0670-024-08R1-P	03045968	6,7 0.264	24,0 0.945	79,0 3.110	43,0 1.693	36,0 1.417	34,0 1.339	8,0 0.315	140°	TiAIN	IT8-9
SD203A-0675-024-08R1-P	03046070	6,747 0.266	24,0 0.945	79,0 3.110	43,0 1.693	36,0 1.417	34,0 1.339	8,0 0.315	140°	TiAIN	IT8-9
SD203A-0680-024-08R1-P	03045969	6,8 0.268	24,0 0.945	79,0 3.110	43,0 1.693	36,0 1.417	34,0 1.339	8,0 0.315	140°	TiAIN	IT8-9
SD203A-0690-024-08R1-P	03045970	6,9 0.272	24,0 0.945	79,0 3.110	43,0 1.693	36,0 1.417	34,0 1.339	8,0 0.315	140°	TiAIN	IT8-9
SD203A-0700-024-08R1-P	03045971	7,0 0.276	24,0 0.945	79,0 3.110	43,0 1.693	36,0 1.417	34,0 1.339	8,0 0.315	140°	TiAIN	IT8-9
SD203A-0710-029-08R1-P	03045972	7,1 0.280	29,0 1.142	79,0 3.110	43,0 1.693	36,0 1.417	41,0 1.614	8,0 0.315	140°	TiAIN	IT8-9
SD203A-0714-029-08R1-P	03046071	7,144 0.281	29,0 1.142	79,0 3.110	43,0 1.693	36,0 1.417	41,0 1.614	8,0 0.315	140°	TiAIN	IT8-9
SD203A-0720-029-08R1-P	03045973	7,2 0.283	29,0 1.142	79,0 3.110	43,0 1.693	36,0 1.417	41,0 1.614	8,0 0.315	140°	TiAIN	IT8-9
SD203A-0730-029-08R1-P	03045974	7,3 0.287	29,0 1.142	79,0 3.110	43,0 1.693	36,0 1.417	41,0 1.614	8,0 0.315	140°	TiAIN	IT8-9
SD203A-0740-029-08R1-P	03045975	7,4 0.291	29,0 1.142	79,0 3.110	43,0 1.693	36,0 1.417	41,0 1.614	8,0 0.315	140°	TiAIN	IT8-9
SD203A-0750-029-08R1-P	03045976	7,5 0.295	29,0 1.142	79,0 3.110	43,0 1.693	36,0 1.417	41,0 1.614	8,0 0.315	140°	TiAIN	IT8-9
SD203A-0754-029-08R1-P	03046072	7,541 0.297	29,0 1.142	79,0 3.110	43,0 1.693	36,0 1.417	41,0 1.614	8,0 0.315	140°	TiAIN	IT8-9
SD203A-0755-029-08R1-P	03045977	7,55 0.297	29,0 1.142	79,0 3.110	43,0 1.693	36,0 1.417	41,0 1.614	8,0 0.315	140°	TiAIN	IT8-9
SD203A-0760-029-08R1-P	03045978	7,6 0.299	29,0 1.142	79,0 3.110	43,0 1.693	36,0 1.417	41,0 1.614	8,0 0.315	140°	TiAIN	IT8-9
SD203A-0770-029-08R1-P	03045979	7,7 0.303	29,0 1.142	79,0 3.110	43,0 1.693	36,0 1.417	41,0 1.614	8,0 0.315	140°	TiAIN	IT8-9
SD203A-0780-029-08R1-P	03045980	7,8 0.307	29,0 1.142	79,0 3.110	43,0 1.693	36,0 1.417	41,0 1.614	8,0 0.315	140°	TiAIN	IT8-9
SD203A-0790-029-08R1-P	03045981	7,9 0.311	29,0 1.142	79,0 3.110	43,0 1.693	36,0 1.417	41,0 1.614	8,0 0.315	140°	TiAIN	IT8-9
SD203A-0794-029-08R1-P	03046073	7,938 0.313	29,0 1.142	79,0 3.110	43,0 1.693	36,0 1.417	41,0 1.614	8,0 0.315	140°	TiAIN	IT8-9
SD203A-0800-029-08R1-P	03045982	8,0 0.315	29,0 1.142	79,0 3.110	43,0 1.693	36,0 1.417	41,0 1.614	8,0 0.315	140°	TiAIN	IT8-9
SD203A-0810-035-10R1-P	03045983	8,1 0.319	35,0 1.378	89,0 3.504	49,0 1.929	40,0 1.575	47,0 1.850	10,0 0.394	140°	TiAIN	IT8-9
SD203A-0820-035-10R1-P	03045984	8,2 0.323	35,0 1.378	89,0 3.504	49,0 1.929	40,0 1.575	47,0 1.850	10,0 0.394	140°	TiAIN	IT8-9
SD203A-0830-035-10R1-P	03045985	8,3 0.327	35,0 1.378	89,0 3.504	49,0 1.929	40,0 1.575	47,0 1.850	10,0 0.394	140°	TiAIN	IT8-9

Introduzione

Foratura

Alesatura

Barenatura

Allegato

Codice di ordinazione	Codice prodotto	DC	LU	OAL	LFS	LS	LCF	DMM	Angolo di punta	Rivestimento	Tolleranza foro
		mm Inch	mm Inch	mm Inch	mm Inch	mm Inch	mm Inch	mm Inch			
SD203A-0833-035-10R1-P	03046074	8,334 0.328	35,0 1.378	89,0 3.504	49,0 1.929	40,0 1.575	47,0 1.850	10,0 0.394	140°	TiAIN	IT8-9
SD203A-0840-035-10R1-P	03045986	8,4 0.331	35,0 1.378	89,0 3.504	49,0 1.929	40,0 1.575	47,0 1.850	10,0 0.394	140°	TiAIN	IT8-9
SD203A-0850-035-10R1-P	03045987	8,5 0.335	35,0 1.378	89,0 3.504	49,0 1.929	40,0 1.575	47,0 1.850	10,0 0.394	140°	TiAIN	IT8-9
SD203A-0860-035-10R1-P	03045988	8,6 0.339	35,0 1.378	89,0 3.504	49,0 1.929	40,0 1.575	47,0 1.850	10,0 0.394	140°	TiAIN	IT8-9
SD203A-0870-035-10R1-P	03045989	8,7 0.343	35,0 1.378	89,0 3.504	49,0 1.929	40,0 1.575	47,0 1.850	10,0 0.394	140°	TiAIN	IT8-9
SD203A-0873-035-10R1-P	03046075	8,731 0.344	35,0 1.378	89,0 3.504	49,0 1.929	40,0 1.575	47,0 1.850	10,0 0.394	140°	TiAIN	IT8-9
SD203A-0880-035-10R1-P	03045990	8,8 0.346	35,0 1.378	89,0 3.504	49,0 1.929	40,0 1.575	47,0 1.850	10,0 0.394	140°	TiAIN	IT8-9
SD203A-0890-035-10R1-P	03045991	8,9 0.350	35,0 1.378	89,0 3.504	49,0 1.929	40,0 1.575	47,0 1.850	10,0 0.394	140°	TiAIN	IT8-9
SD203A-0900-035-10R1-P	03045992	9,0 0.354	35,0 1.378	89,0 3.504	49,0 1.929	40,0 1.575	47,0 1.850	10,0 0.394	140°	TiAIN	IT8-9
SD203A-0910-035-10R1-P	03045993	9,1 0.358	35,0 1.378	89,0 3.504	49,0 1.929	40,0 1.575	47,0 1.850	10,0 0.394	140°	TiAIN	IT8-9
SD203A-0913-035-10R1-P	03046076	9,128 0.359	35,0 1.378	89,0 3.504	49,0 1.929	40,0 1.575	47,0 1.850	10,0 0.394	140°	TiAIN	IT8-9
SD203A-0920-035-10R1-P	03045994	9,2 0.362	35,0 1.378	89,0 3.504	49,0 1.929	40,0 1.575	47,0 1.850	10,0 0.394	140°	TiAIN	IT8-9
SD203A-0930-035-10R1-P	03045995	9,3 0.366	35,0 1.378	89,0 3.504	49,0 1.929	40,0 1.575	47,0 1.850	10,0 0.394	140°	TiAIN	IT8-9
SD203A-0940-035-10R1-P	03045996	9,4 0.370	35,0 1.378	89,0 3.504	49,0 1.929	40,0 1.575	47,0 1.850	10,0 0.394	140°	TiAIN	IT8-9
SD203A-0950-035-10R1-P	03045997	9,5 0.374	35,0 1.378	89,0 3.504	49,0 1.929	40,0 1.575	47,0 1.850	10,0 0.394	140°	TiAIN	IT8-9
SD203A-0953-035-10R1-P	03046077	9,525 0.375	35,0 1.378	89,0 3.504	49,0 1.929	40,0 1.575	47,0 1.850	10,0 0.394	140°	TiAIN	IT8-9
SD203A-0955-035-10R1-P	03045998	9,55 0.376	35,0 1.378	89,0 3.504	49,0 1.929	40,0 1.575	47,0 1.850	10,0 0.394	140°	TiAIN	IT8-9
SD203A-0960-035-10R1-P	03045999	9,6 0.378	35,0 1.378	89,0 3.504	49,0 1.929	40,0 1.575	47,0 1.850	10,0 0.394	140°	TiAIN	IT8-9
SD203A-0970-035-10R1-P	03046000	9,7 0.382	35,0 1.378	89,0 3.504	49,0 1.929	40,0 1.575	47,0 1.850	10,0 0.394	140°	TiAIN	IT8-9
SD203A-0980-035-10R1-P	03046001	9,8 0.386	35,0 1.378	89,0 3.504	49,0 1.929	40,0 1.575	47,0 1.850	10,0 0.394	140°	TiAIN	IT8-9
SD203A-0990-035-10R1-P	03046002	9,9 0.390	35,0 1.378	89,0 3.504	49,0 1.929	40,0 1.575	47,0 1.850	10,0 0.394	140°	TiAIN	IT8-9
SD203A-0992-035-10R1-P	03046078	9,922 0.391	35,0 1.378	89,0 3.504	49,0 1.929	40,0 1.575	47,0 1.850	10,0 0.394	140°	TiAIN	IT8-9
SD203A-1000-035-10R1-P	03046003	10,0 0.394	35,0 1.378	89,0 3.504	49,0 1.929	40,0 1.575	47,0 1.850	10,0 0.394	140°	TiAIN	IT8-9
SD203A-1020-040-12R1-P	03046004	10,2 0.402	40,0 1.575	102,0 4.016	57,0 2.244	45,0 1.772	55,0 2.165	12,0 0.472	140°	TiAIN	IT8-9
SD203A-1032-040-12R1-P	03046079	10,319 0.406	40,0 1.575	102,0 4.016	57,0 2.244	45,0 1.772	55,0 2.165	12,0 0.472	140°	TiAIN	IT8-9
SD203A-1040-040-12R1-P	03046005	10,4 0.409	40,0 1.575	102,0 4.016	57,0 2.244	45,0 1.772	55,0 2.165	12,0 0.472	140°	TiAIN	IT8-9
SD203A-1050-040-12R1-P	03046006	10,5 0.413	40,0 1.575	102,0 4.016	57,0 2.244	45,0 1.772	55,0 2.165	12,0 0.472	140°	TiAIN	IT8-9
SD203A-1060-040-12R1-P	03046007	10,6 0.417	40,0 1.575	102,0 4.016	57,0 2.244	45,0 1.772	55,0 2.165	12,0 0.472	140°	TiAIN	IT8-9
SD203A-1072-040-12R1-P	03046080	10,716 0.422	40,0 1.575	102,0 4.016	57,0 2.244	45,0 1.772	55,0 2.165	12,0 0.472	140°	TiAIN	IT8-9
SD203A-1080-040-12R1-P	03046008	10,8 0.425	40,0 1.575	102,0 4.016	57,0 2.244	45,0 1.772	55,0 2.165	12,0 0.472	140°	TiAIN	IT8-9
SD203A-1090-040-12R1-P	03046009	10,9 0.429	40,0 1.575	102,0 4.016	57,0 2.244	45,0 1.772	55,0 2.165	12,0 0.472	140°	TiAIN	IT8-9

Codice di ordinazione	Codice prodotto	DC	LU	OAL	LFS	LS	LCF	DMM	Angolo di punta	Rivestimento	Tolleranza foro
		mm Inch	mm Inch	mm Inch	mm Inch	mm Inch	mm Inch	mm Inch			
SD203A-1100-040-12R1-P	03046010	11,0 0.433	40,0 1.575	102,0 4.016	57,0 2.244	45,0 1.772	55,0 2.165	12,0 0.472	140°	TiAIN	IT8-9
SD203A-1110-040-12R1-P	03046011	11,1 0.437	40,0 1.575	102,0 4.016	57,0 2.244	45,0 1.772	55,0 2.165	12,0 0.472	140°	TiAIN	IT8-9
SD203A-1111-040-12R1-P	03046081	11,113 0.438	40,0 1.575	102,0 4.016	57,0 2.244	45,0 1.772	55,0 2.165	12,0 0.472	140°	TiAIN	IT8-9
SD203A-1120-040-12R1-P	03046012	11,2 0.441	40,0 1.575	102,0 4.016	57,0 2.244	45,0 1.772	55,0 2.165	12,0 0.472	140°	TiAIN	IT8-9
SD203A-1130-040-12R1-P	03046013	11,3 0.445	40,0 1.575	102,0 4.016	57,0 2.244	45,0 1.772	55,0 2.165	12,0 0.472	140°	TiAIN	IT8-9
SD203A-1140-040-12R1-P	03046014	11,4 0.449	40,0 1.575	102,0 4.016	57,0 2.244	45,0 1.772	55,0 2.165	12,0 0.472	140°	TiAIN	IT8-9
SD203A-1150-040-12R1-P	03046015	11,5 0.453	40,0 1.575	102,0 4.016	57,0 2.244	45,0 1.772	55,0 2.165	12,0 0.472	140°	TiAIN	IT8-9
SD203A-1151-040-12R1-P	03046082	11,509 0.453	40,0 1.575	102,0 4.016	57,0 2.244	45,0 1.772	55,0 2.165	12,0 0.472	140°	TiAIN	IT8-9
SD203A-1155-040-12R1-P	03046016	11,55 0.455	40,0 1.575	102,0 4.016	57,0 2.244	45,0 1.772	55,0 2.165	12,0 0.472	140°	TiAIN	IT8-9
SD203A-1160-040-12R1-P	03046017	11,6 0.457	40,0 1.575	102,0 4.016	57,0 2.244	45,0 1.772	55,0 2.165	12,0 0.472	140°	TiAIN	IT8-9
SD203A-1170-040-12R1-P	03046018	11,7 0.461	40,0 1.575	102,0 4.016	57,0 2.244	45,0 1.772	55,0 2.165	12,0 0.472	140°	TiAIN	IT8-9
SD203A-1180-040-12R1-P	03046019	11,8 0.465	40,0 1.575	102,0 4.016	57,0 2.244	45,0 1.772	55,0 2.165	12,0 0.472	140°	TiAIN	IT8-9
SD203A-1190-040-12R1-P	03046020	11,9 0.469	40,0 1.575	102,0 4.016	57,0 2.244	45,0 1.772	55,0 2.165	12,0 0.472	140°	TiAIN	IT8-9
SD203A-1191-040-12R1-P	03046083	11,906 0.469	40,0 1.575	102,0 4.016	57,0 2.244	45,0 1.772	55,0 2.165	12,0 0.472	140°	TiAIN	IT8-9
SD203A-1200-040-12R1-P	03046021	12,0 0.472	40,0 1.575	102,0 4.016	57,0 2.244	45,0 1.772	55,0 2.165	12,0 0.472	140°	TiAIN	IT8-9
SD203A-1210-043-14R1-P	03046022	12,1 0.476	43,0 1.693	107,0 4.213	62,0 2.441	45,0 1.772	60,0 2.362	14,0 0.551	140°	TiAIN	IT8-9
SD203A-1220-043-14R1-P	03046023	12,2 0.480	43,0 1.693	107,0 4.213	62,0 2.441	45,0 1.772	60,0 2.362	14,0 0.551	140°	TiAIN	IT8-9
SD203A-1230-043-14R1-P	03046084	12,303 0.484	43,0 1.693	107,0 4.213	62,0 2.441	45,0 1.772	60,0 2.362	14,0 0.551	140°	TiAIN	IT8-9
SD203A-1240-043-14R1-P	03046024	12,4 0.488	43,0 1.693	107,0 4.213	62,0 2.441	45,0 1.772	60,0 2.362	14,0 0.551	140°	TiAIN	IT8-9
SD203A-1250-043-14R1-P	03046025	12,5 0.492	43,0 1.693	107,0 4.213	62,0 2.441	45,0 1.772	60,0 2.362	14,0 0.551	140°	TiAIN	IT8-9
SD203A-1260-043-14R1-P	03046026	12,6 0.496	43,0 1.693	107,0 4.213	62,0 2.441	45,0 1.772	60,0 2.362	14,0 0.551	140°	TiAIN	IT8-9
SD203A-1270-043-14R1-P	03046085	12,7 0.500	43,0 1.693	107,0 4.213	62,0 2.441	45,0 1.772	60,0 2.362	14,0 0.551	140°	TiAIN	IT8-9
SD203A-1275-043-14R1-P	03046027	12,75 0.502	43,0 1.693	107,0 4.213	62,0 2.441	45,0 1.772	60,0 2.362	14,0 0.551	140°	TiAIN	IT8-9
SD203A-1280-043-14R1-P	03046028	12,8 0.504	43,0 1.693	107,0 4.213	62,0 2.441	45,0 1.772	60,0 2.362	14,0 0.551	140°	TiAIN	IT8-9
SD203A-1290-043-14R1-P	03046029	12,9 0.508	43,0 1.693	107,0 4.213	62,0 2.441	45,0 1.772	60,0 2.362	14,0 0.551	140°	TiAIN	IT8-9
SD203A-1300-043-14R1-P	03046030	13,0 0.512	43,0 1.693	107,0 4.213	62,0 2.441	45,0 1.772	60,0 2.362	14,0 0.551	140°	TiAIN	IT8-9
SD203A-1310-043-14R1-P	03046031	13,1 0.516	43,0 1.693	107,0 4.213	62,0 2.441	45,0 1.772	60,0 2.362	14,0 0.551	140°	TiAIN	IT8-9
SD203A-1320-043-14R1-P	03046032	13,2 0.520	43,0 1.693	107,0 4.213	62,0 2.441	45,0 1.772	60,0 2.362	14,0 0.551	140°	TiAIN	IT8-9
SD203A-1330-043-14R1-P	03046033	13,3 0.524	43,0 1.693	107,0 4.213	62,0 2.441	45,0 1.772	60,0 2.362	14,0 0.551	140°	TiAIN	IT8-9
SD203A-1340-043-14R1-P	03046034	13,4 0.528	43,0 1.693	107,0 4.213	62,0 2.441	45,0 1.772	60,0 2.362	14,0 0.551	140°	TiAIN	IT8-9
SD203A-1349-043-14R1-P	03046086	13,494 0.531	43,0 1.693	107,0 4.213	62,0 2.441	45,0 1.772	60,0 2.362	14,0 0.551	140°	TiAIN	IT8-9

Introduzione

Foratura

Alesatura

Barenatura

Allegato

Codice di ordinazione	Codice prodotto	DC	LU	OAL	LFS	LS	LCF	DMM	Angolo di punta	Rivestimento	Tolleranza foro
		mm Inch	mm Inch	mm Inch	mm Inch	mm Inch	mm Inch	mm Inch			
SD203A-1350-043-14R1-P	03046035	13,5 0.531	43,0 1.693	107,0 4.213	62,0 2.441	45,0 1.772	60,0 2.362	14,0 0.551	140°	TiAIN	IT8-9
SD203A-1360-043-14R1-P	03046036	13,6 0.535	43,0 1.693	107,0 4.213	62,0 2.441	45,0 1.772	60,0 2.362	14,0 0.551	140°	TiAIN	IT8-9
SD203A-1370-043-14R1-P	03046037	13,7 0.539	43,0 1.693	107,0 4.213	62,0 2.441	45,0 1.772	60,0 2.362	14,0 0.551	140°	TiAIN	IT8-9
SD203A-1380-043-14R1-P	03046038	13,8 0.543	43,0 1.693	107,0 4.213	62,0 2.441	45,0 1.772	60,0 2.362	14,0 0.551	140°	TiAIN	IT8-9
SD203A-1390-043-14R1-P	03046039	13,9 0.547	43,0 1.693	107,0 4.213	62,0 2.441	45,0 1.772	60,0 2.362	14,0 0.551	140°	TiAIN	IT8-9
SD203A-1400-043-14R1-P	03046040	14,0 0.551	43,0 1.693	107,0 4.213	62,0 2.441	45,0 1.772	60,0 2.362	14,0 0.551	140°	TiAIN	IT8-9
SD203A-1420-045-16R1-P	03046041	14,2 0.559	45,0 1.772	115,0 4.528	67,0 2.638	48,0 1.890	65,0 2.559	16,0 0.630	140°	TiAIN	IT8-9
SD203A-1425-045-16R1-P	03138155	14,25 0.561	45,0 1.772	115,0 4.528	67,0 2.638	48,0 1.890	65,0 2.559	16,0 0.630	140°	TiAIN	IT8-9
SD203A-1429-045-16R1-P	03046087	14,288 0.563	45,0 1.772	115,0 4.528	67,0 2.638	48,0 1.890	65,0 2.559	16,0 0.630	140°	TiAIN	IT8-9
SD203A-1450-045-16R1-P	03046042	14,5 0.571	45,0 1.772	115,0 4.528	67,0 2.638	48,0 1.890	65,0 2.559	16,0 0.630	140°	TiAIN	IT8-9
SD203A-1470-045-16R1-P	03046043	14,7 0.579	45,0 1.772	115,0 4.528	67,0 2.638	48,0 1.890	65,0 2.559	16,0 0.630	140°	TiAIN	IT8-9
SD203A-1475-045-16R1-P	03046044	14,75 0.581	45,0 1.772	115,0 4.528	67,0 2.638	48,0 1.890	65,0 2.559	16,0 0.630	140°	TiAIN	IT8-9
SD203A-1480-045-16R1-P	03046045	14,8 0.583	45,0 1.772	115,0 4.528	67,0 2.638	48,0 1.890	65,0 2.559	16,0 0.630	140°	TiAIN	IT8-9
SD203A-1500-045-16R1-P	03046046	15,0 0.591	45,0 1.772	115,0 4.528	67,0 2.638	48,0 1.890	65,0 2.559	16,0 0.630	140°	TiAIN	IT8-9
SD203A-1510-045-16R1-P	03046047	15,1 0.594	45,0 1.772	115,0 4.528	67,0 2.638	48,0 1.890	65,0 2.559	16,0 0.630	140°	TiAIN	IT8-9
SD203A-1530-045-16R1-P	03046048	15,3 0.602	45,0 1.772	115,0 4.528	67,0 2.638	48,0 1.890	65,0 2.559	16,0 0.630	140°	TiAIN	IT8-9
SD203A-1550-045-16R1-P	03046049	15,5 0.610	45,0 1.772	115,0 4.528	67,0 2.638	48,0 1.890	65,0 2.559	16,0 0.630	140°	TiAIN	IT8-9
SD203A-1570-045-16R1-P	03046050	15,7 0.618	45,0 1.772	115,0 4.528	67,0 2.638	48,0 1.890	65,0 2.559	16,0 0.630	140°	TiAIN	IT8-9
SD203A-1580-045-16R1-P	03046051	15,8 0.622	45,0 1.772	115,0 4.528	67,0 2.638	48,0 1.890	65,0 2.559	16,0 0.630	140°	TiAIN	IT8-9
SD203A-1588-045-16R1-P	03046088	15,875 0.625	45,0 1.772	115,0 4.528	67,0 2.638	48,0 1.890	65,0 2.559	16,0 0.630	140°	TiAIN	IT8-9
SD203A-1600-045-16R1-P	03046052	16,0 0.630	45,0 1.772	115,0 4.528	67,0 2.638	48,0 1.890	65,0 2.559	16,0 0.630	140°	TiAIN	IT8-9
SD203A-1650-051-18R1-P	03046053	16,5 0.650	51,0 2.008	123,0 4.843	75,0 2.953	48,0 1.890	73,0 2.874	18,0 0.709	140°	TiAIN	IT8-9
SD203A-1700-051-18R1-P	03046054	17,0 0.669	51,0 2.008	123,0 4.843	75,0 2.953	48,0 1.890	73,0 2.874	18,0 0.709	140°	TiAIN	IT8-9
SD203A-1750-051-18R1-P	03046055	17,5 0.689	51,0 2.008	123,0 4.843	75,0 2.953	48,0 1.890	73,0 2.874	18,0 0.709	140°	TiAIN	IT8-9
SD203A-1800-051-18R1-P	03046056	18,0 0.709	51,0 2.008	123,0 4.843	75,0 2.953	48,0 1.890	73,0 2.874	18,0 0.709	140°	TiAIN	IT8-9
SD203A-1850-055-20R1-P	03046057	18,5 0.728	55,0 2.165	131,0 5.157	81,0 3.189	50,0 1.969	79,0 3.110	20,0 0.787	140°	TiAIN	IT8-9
SD203A-1900-055-20R1-P	03046058	19,0 0.748	55,0 2.165	131,0 5.157	81,0 3.189	50,0 1.969	79,0 3.110	20,0 0.787	140°	TiAIN	IT8-9
SD203A-1905-055-20R1-P	03046089	19,05 0.750	55,0 2.165	131,0 5.157	81,0 3.189	50,0 1.969	79,0 3.110	20,0 0.787	140°	TiAIN	IT8-9
SD203A-1950-055-20R1-P	03046059	19,5 0.768	55,0 2.165	131,0 5.157	81,0 3.189	50,0 1.969	79,0 3.110	20,0 0.787	140°	TiAIN	IT8-9
SD203A-1980-055-20R1-P	03138156	19,8 0.780	55,0 2.165	131,0 5.157	81,0 3.189	50,0 1.969	79,0 3.110	20,0 0.787	140°	TiAIN	IT8-9
SD203A-2000-055-20R1-P	03046060	20,0 0.787	55,0 2.165	131,0 5.157	81,0 3.189	50,0 1.969	79,0 3.110	20,0 0.787	140°	TiAIN	IT8-9

SD205A-P

Profondità di foratura ~ 5 x D – Misure metriche/Pollici

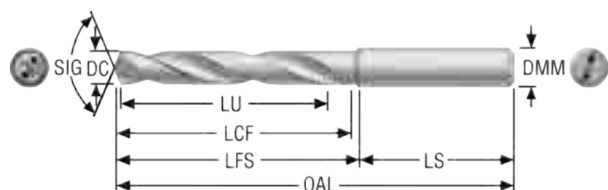

- Codolo cilindrico DIN 6537A
- Tolleranza DC m7
- Adduzione refrigerante interna
- Per i parametri di taglio raccomandati, vedere pagina(e) 147-148
- Per i diametri intermedi, utilizzare MyDesign.

Codice di ordinazione	Codice prodotto	DC	LU	OAL	LFS	LS	LCF	DMM	Angolo di punta	Rivestimento	Tolleranza foro
		mm Inch	mm Inch	mm Inch	mm Inch	mm Inch	mm Inch	mm Inch			
SD205A-0200-012-04R1-P	03046131	2,0 0.079	12,0 0.472	46,0 1.811	19,0 mm 0.748	27,0 1.063	15,0 0.591	4,0 0.157	140°	TiAlN	IT8-9
SD205A-0210-012-04R1-P	03046132	2,1 0.083	12,0 0.472	46,0 1.811	19,0 mm 0.748	27,0 1.063	15,0 0.591	4,0 0.157	140°	TiAlN	IT8-9
SD205A-0220-012-04R1-P	03046133	2,2 0.087	12,0 0.472	46,0 1.811	19,0 mm 0.748	27,0 1.063	15,0 0.591	4,0 0.157	140°	TiAlN	IT8-9
SD205A-0230-012-04R1-P	03046134	2,3 0.091	12,0 0.472	46,0 1.811	19,0 mm 0.748	27,0 1.063	15,0 0.591	4,0 0.157	140°	TiAlN	IT8-9
SD205A-0238-013-04R1-P	03120477	2,381 0.094	13,0 0.512	50,0 1.969	23,0 mm 0.906	27,0 1.063	17,5 0.689	4,0 0.157	140°	TiAlN	IT8-9
SD205A-0240-013-04R1-P	03046135	2,4 0.094	13,0 0.512	50,0 1.969	23,0 mm 0.906	27,0 1.063	17,5 0.689	4,0 0.157	140°	TiAlN	IT8-9
SD205A-0250-013-04R1-P	03046136	2,5 0.098	13,0 0.512	50,0 1.969	23,0 mm 0.906	27,0 1.063	17,5 0.689	4,0 0.157	140°	TiAlN	IT8-9
SD205A-0260-013-04R1-P	03046137	2,6 0.102	13,0 0.512	50,0 1.969	23,0 mm 0.906	27,0 1.063	17,5 0.689	4,0 0.157	140°	TiAlN	IT8-9
SD205A-0270-015-04R1-P	03046138	2,7 0.106	15,0 0.591	50,0 1.969	23,0 mm 0.906	27,0 1.063	20,5 0.807	4,0 0.157	140°	TiAlN	IT8-9
SD205A-0278-015-04R1-P	03120496	2,778 0.109	15,0 0.591	50,0 1.969	23,0 mm 0.906	27,0 1.063	20,5 0.807	4,0 0.157	140°	TiAlN	IT8-9
SD205A-0280-015-04R1-P	03046139	2,8 0.110	15,0 0.591	50,0 1.969	23,0 mm 0.906	27,0 1.063	20,5 0.807	4,0 0.157	140°	TiAlN	IT8-9
SD205A-0290-015-04R1-P	03046141	2,9 0.114	15,0 0.591	50,0 1.969	23,0 mm 0.906	27,0 1.063	20,5 0.807	4,0 0.157	140°	TiAlN	IT8-9
SD205A-0300-023-06R1-P	03046142	3,0 0.118	23,0 0.906	66,0 2.598	30,0 mm 1.181	36,0 1.417	26,0 1.024	6,0 0.236	140°	TiAlN	IT8-9
SD205A-0310-023-06R1-P	03046143	3,1 0.122	23,0 0.906	66,0 2.598	30,0 mm 1.181	36,0 1.417	26,0 1.024	6,0 0.236	140°	TiAlN	IT8-9
SD205A-0318-023-06R1-P	03046327	3,175 0.125	23,0 0.906	66,0 2.598	30,0 mm 1.181	36,0 1.417	26,0 1.024	6,0 0.236	140°	TiAlN	IT8-9
SD205A-0320-023-06R1-P	03046144	3,2 0.126	23,0 0.906	66,0 2.598	30,0 mm 1.181	36,0 1.417	26,0 1.024	6,0 0.236	140°	TiAlN	IT8-9
SD205A-0325-023-06R1-P	03046145	3,25 0.128	23,0 0.906	66,0 2.598	30,0 mm 1.181	36,0 1.417	26,0 1.024	6,0 0.236	140°	TiAlN	IT8-9
SD205A-0330-023-06R1-P	03046146	3,3 0.130	23,0 0.906	66,0 2.598	30,0 mm 1.181	36,0 1.417	26,0 1.024	6,0 0.236	140°	TiAlN	IT8-9
SD205A-0340-023-06R1-P	03046147	3,4 0.134	23,0 0.906	66,0 2.598	30,0 mm 1.181	36,0 1.417	26,0 1.024	6,0 0.236	140°	TiAlN	IT8-9
SD205A-0350-023-06R1-P	03046148	3,5 0.138	23,0 0.906	66,0 2.598	30,0 mm 1.181	36,0 1.417	26,0 1.024	6,0 0.236	140°	TiAlN	IT8-9
SD205A-0357-023-06R1-P	03046328	3,572 0.141	23,0 0.906	66,0 2.598	30,0 mm 1.181	36,0 1.417	26,0 1.024	6,0 0.236	140°	TiAlN	IT8-9
SD205A-0360-023-06R1-P	03046149	3,6 0.142	23,0 0.906	66,0 2.598	30,0 mm 1.181	36,0 1.417	26,0 1.024	6,0 0.236	140°	TiAlN	IT8-9

Codice di ordinazione	Codice prodotto	DC	LU	OAL	LFS	LS	LCF	DMM	Angolo di punta	Rivestimento	Tolleranza foro
		mm Inch	mm Inch	mm Inch	mm Inch	mm Inch	mm Inch	mm Inch			
SD205A-0365-023-06R1-P	03046150	3,65 0.144	23,0 0.906	66,0 2.598	30,0 mm 1.181	36,0 1.417	26,0 1.024	6,0 0.236	140°	TiAIN	IT8-9
SD205A-0370-023-06R1-P	03046151	3,7 0.146	23,0 0.906	66,0 2.598	30,0 mm 1.181	36,0 1.417	26,0 1.024	6,0 0.236	140°	TiAIN	IT8-9
SD205A-0380-029-06R1-P	03046152	3,8 0.150	29,0 1.142	74,0 2.913	38,0 mm 1.496	36,0 1.417	34,0 1.339	6,0 0.236	140°	TiAIN	IT8-9
SD205A-0390-029-06R1-P	03046153	3,9 0.154	29,0 1.142	74,0 2.913	38,0 mm 1.496	36,0 1.417	34,0 1.339	6,0 0.236	140°	TiAIN	IT8-9
SD205A-0397-029-06R1-P	03046329	3,97 0.156	29,0 1.142	74,0 2.913	38,0 mm 1.496	36,0 1.417	34,0 1.339	6,0 0.236	140°	TiAIN	IT8-9
SD205A-0400-029-06R1-P	03046154	4,0 0.157	29,0 1.142	74,0 2.913	38,0 mm 1.496	36,0 1.417	34,0 1.339	6,0 0.236	140°	TiAIN	IT8-9
SD205A-0410-029-06R1-P	03046155	4,1 0.161	29,0 1.142	74,0 2.913	38,0 mm 1.496	36,0 1.417	34,0 1.339	6,0 0.236	140°	TiAIN	IT8-9
SD205A-0420-029-06R1-P	03046157	4,2 0.165	29,0 1.142	74,0 2.913	38,0 mm 1.496	36,0 1.417	34,0 1.339	6,0 0.236	140°	TiAIN	IT8-9
SD205A-0430-029-06R1-P	03046158	4,3 0.169	29,0 1.142	74,0 2.913	38,0 mm 1.496	36,0 1.417	34,0 1.339	6,0 0.236	140°	TiAIN	IT8-9
SD205A-0437-029-06R1-P	03046330	4,366 0.172	29,0 1.142	74,0 2.913	38,0 mm 1.496	36,0 1.417	34,0 1.339	6,0 0.236	140°	TiAIN	IT8-9
SD205A-0440-029-06R1-P	03046159	4,4 0.173	29,0 1.142	74,0 2.913	38,0 mm 1.496	36,0 1.417	34,0 1.339	6,0 0.236	140°	TiAIN	IT8-9
SD205A-0450-029-06R1-P	03046160	4,5 0.177	29,0 1.142	74,0 2.913	38,0 mm 1.496	36,0 1.417	34,0 1.339	6,0 0.236	140°	TiAIN	IT8-9
SD205A-0460-029-06R1-P	03046161	4,6 0.181	29,0 1.142	74,0 2.913	38,0 mm 1.496	36,0 1.417	34,0 1.339	6,0 0.236	140°	TiAIN	IT8-9
SD205A-0465-029-06R1-P	03046162	4,65 0.183	29,0 1.142	74,0 2.913	38,0 mm 1.496	36,0 1.417	34,0 1.339	6,0 0.236	140°	TiAIN	IT8-9
SD205A-0470-029-06R1-P	03046163	4,7 0.185	29,0 1.142	74,0 2.913	38,0 mm 1.496	36,0 1.417	34,0 1.339	6,0 0.236	140°	TiAIN	IT8-9
SD205A-0476-035-06R1-P	03046331	4,763 0.188	35,0 1.378	82,0 3.228	46,0 mm 1.811	36,0 1.417	44,0 1.732	6,0 0.236	140°	TiAIN	IT8-9
SD205A-0480-035-06R1-P	03046164	4,8 0.189	35,0 1.378	82,0 3.228	46,0 mm 1.811	36,0 1.417	44,0 1.732	6,0 0.236	140°	TiAIN	IT8-9
SD205A-0490-035-06R1-P	03046165	4,9 0.193	35,0 1.378	82,0 3.228	46,0 mm 1.811	36,0 1.417	44,0 1.732	6,0 0.236	140°	TiAIN	IT8-9
SD205A-0500-035-06R1-P	03046166	5,0 0.197	35,0 1.378	82,0 3.228	46,0 mm 1.811	36,0 1.417	44,0 1.732	6,0 0.236	140°	TiAIN	IT8-9
SD205A-0510-035-06R1-P	03046167	5,1 0.201	35,0 1.378	82,0 3.228	46,0 mm 1.811	36,0 1.417	44,0 1.732	6,0 0.236	140°	TiAIN	IT8-9
SD205A-0516-035-06R1-P	03046332	5,159 0.203	35,0 1.378	82,0 3.228	46,0 mm 1.811	36,0 1.417	44,0 1.732	6,0 0.236	140°	TiAIN	IT8-9
SD205A-0520-035-06R1-P	03046168	5,2 0.205	35,0 1.378	82,0 3.228	46,0 mm 1.811	36,0 1.417	44,0 1.732	6,0 0.236	140°	TiAIN	IT8-9
SD205A-0530-035-06R1-P	03046169	5,3 0.209	35,0 1.378	82,0 3.228	46,0 mm 1.811	36,0 1.417	44,0 1.732	6,0 0.236	140°	TiAIN	IT8-9
SD205A-0540-035-06R1-P	03046170	5,4 0.213	35,0 1.378	82,0 3.228	46,0 mm 1.811	36,0 1.417	44,0 1.732	6,0 0.236	140°	TiAIN	IT8-9
SD205A-0550-035-06R1-P	03046171	5,5 0.217	35,0 1.378	82,0 3.228	46,0 mm 1.811	36,0 1.417	44,0 1.732	6,0 0.236	140°	TiAIN	IT8-9
SD205A-0555-035-06R1-P	03046172	5,55 0.219	35,0 1.378	82,0 3.228	46,0 mm 1.811	36,0 1.417	44,0 1.732	6,0 0.236	140°	TiAIN	IT8-9
SD205A-0556-035-06R1-P	03046333	5,556 0.219	35,0 1.378	82,0 3.228	46,0 mm 1.811	36,0 1.417	44,0 1.732	6,0 0.236	140°	TiAIN	IT8-9
SD205A-0560-035-06R1-P	03046173	5,6 0.220	35,0 1.378	82,0 3.228	46,0 mm 1.811	36,0 1.417	44,0 1.732	6,0 0.236	140°	TiAIN	IT8-9
SD205A-0570-035-06R1-P	03046174	5,7 0.224	35,0 1.378	82,0 3.228	46,0 mm 1.811	36,0 1.417	44,0 1.732	6,0 0.236	140°	TiAIN	IT8-9
SD205A-0580-035-06R1-P	03046175	5,8 0.228	35,0 1.378	82,0 3.228	46,0 mm 1.811	36,0 1.417	44,0 1.732	6,0 0.236	140°	TiAIN	IT8-9
SD205A-0590-035-06R1-P	03046176	5,9 0.232	35,0 1.378	82,0 3.228	46,0 mm 1.811	36,0 1.417	44,0 1.732	6,0 0.236	140°	TiAIN	IT8-9

Codice di ordinazione	Codice prodotto	DC	LU	OAL	LFS	LS	LCF	DMM	Angolo di punta	Rivestimento	Tolleranza foro
		mm Inch	mm Inch	mm Inch	mm Inch	mm Inch	mm Inch	mm Inch			
SD205A-0595-035-06R1-P	03046334	5,953 0.234	35,0 1.378	82,0 3.228	46,0 mm 1.811	36,0 1.417	44,0 1.732	6,0 0.236	140°	TiAlN	IT8-9
SD205A-0600-035-06R1-P	03046177	6,0 0.236	35,0 1.378	82,0 3.228	46,0 mm 1.811	36,0 1.417	44,0 1.732	6,0 0.236	140°	TiAlN	IT8-9
SD205A-0610-043-08R1-P	03046179	6,1 0.240	43,0 1.693	91,0 3.583	55,0 mm 2.165	36,0 1.417	53,0 2.087	8,0 0.315	140°	TiAlN	IT8-9
SD205A-0620-043-08R1-P	03046180	6,2 0.244	43,0 1.693	91,0 3.583	55,0 mm 2.165	36,0 1.417	53,0 2.087	8,0 0.315	140°	TiAlN	IT8-9
SD205A-0630-043-08R1-P	03046181	6,3 0.248	43,0 1.693	91,0 3.583	55,0 mm 2.165	36,0 1.417	53,0 2.087	8,0 0.315	140°	TiAlN	IT8-9
SD205A-0635-043-08R1-P	03046335	6,35 0.250	43,0 1.693	91,0 3.583	55,0 mm 2.165	36,0 1.417	53,0 2.087	8,0 0.315	140°	TiAlN	IT8-9
SD205A-0640-043-08R1-P	03046182	6,4 0.252	43,0 1.693	91,0 3.583	55,0 mm 2.165	36,0 1.417	53,0 2.087	8,0 0.315	140°	TiAlN	IT8-9
SD205A-0650-043-08R1-P	03046183	6,5 0.256	43,0 1.693	91,0 3.583	55,0 mm 2.165	36,0 1.417	53,0 2.087	8,0 0.315	140°	TiAlN	IT8-9
SD205A-0660-043-08R1-P	03046184	6,6 0.260	43,0 1.693	91,0 3.583	55,0 mm 2.165	36,0 1.417	53,0 2.087	8,0 0.315	140°	TiAlN	IT8-9
SD205A-0670-043-08R1-P	03046185	6,7 0.264	43,0 1.693	91,0 3.583	55,0 mm 2.165	36,0 1.417	53,0 2.087	8,0 0.315	140°	TiAlN	IT8-9
SD205A-0675-043-08R1-P	03046336	6,747 0.266	43,0 1.693	91,0 3.583	55,0 mm 2.165	36,0 1.417	53,0 2.087	8,0 0.315	140°	TiAlN	IT8-9
SD205A-0680-043-08R1-P	03046186	6,8 0.268	43,0 1.693	91,0 3.583	55,0 mm 2.165	36,0 1.417	53,0 2.087	8,0 0.315	140°	TiAlN	IT8-9
SD205A-0690-043-08R1-P	03046187	6,9 0.272	43,0 1.693	91,0 3.583	55,0 mm 2.165	36,0 1.417	53,0 2.087	8,0 0.315	140°	TiAlN	IT8-9
SD205A-0700-043-08R1-P	03046188	7,0 0.276	43,0 1.693	91,0 3.583	55,0 mm 2.165	36,0 1.417	53,0 2.087	8,0 0.315	140°	TiAlN	IT8-9
SD205A-0710-043-08R1-P	03046190	7,1 0.280	43,0 1.693	91,0 3.583	55,0 mm 2.165	36,0 1.417	53,0 2.087	8,0 0.315	140°	TiAlN	IT8-9
SD205A-0714-043-08R1-P	03046337	7,144 0.281	43,0 1.693	91,0 3.583	55,0 mm 2.165	36,0 1.417	53,0 2.087	8,0 0.315	140°	TiAlN	IT8-9
SD205A-0720-043-08R1-P	03046191	7,2 0.283	43,0 1.693	91,0 3.583	55,0 mm 2.165	36,0 1.417	53,0 2.087	8,0 0.315	140°	TiAlN	IT8-9
SD205A-0730-043-08R1-P	03046192	7,3 0.287	43,0 1.693	91,0 3.583	55,0 mm 2.165	36,0 1.417	53,0 2.087	8,0 0.315	140°	TiAlN	IT8-9
SD205A-0740-043-08R1-P	03046193	7,4 0.291	43,0 1.693	91,0 3.583	55,0 mm 2.165	36,0 1.417	53,0 2.087	8,0 0.315	140°	TiAlN	IT8-9
SD205A-0750-043-08R1-P	03046194	7,5 0.295	43,0 1.693	91,0 3.583	55,0 mm 2.165	36,0 1.417	53,0 2.087	8,0 0.315	140°	TiAlN	IT8-9
SD205A-0754-043-08R1-P	03046338	7,541 0.297	43,0 1.693	91,0 3.583	55,0 mm 2.165	36,0 1.417	53,0 2.087	8,0 0.315	140°	TiAlN	IT8-9
SD205A-0755-043-08R1-P	03046195	7,55 0.297	43,0 1.693	91,0 3.583	55,0 mm 2.165	36,0 1.417	53,0 2.087	8,0 0.315	140°	TiAlN	IT8-9
SD205A-0760-043-08R1-P	03046196	7,6 0.299	43,0 1.693	91,0 3.583	55,0 mm 2.165	36,0 1.417	53,0 2.087	8,0 0.315	140°	TiAlN	IT8-9
SD205A-0770-043-08R1-P	03046197	7,7 0.303	43,0 1.693	91,0 3.583	55,0 mm 2.165	36,0 1.417	53,0 2.087	8,0 0.315	140°	TiAlN	IT8-9
SD205A-0780-043-08R1-P	03046198	7,8 0.307	43,0 1.693	91,0 3.583	55,0 mm 2.165	36,0 1.417	53,0 2.087	8,0 0.315	140°	TiAlN	IT8-9
SD205A-0790-043-08R1-P	03046199	7,9 0.311	43,0 1.693	91,0 3.583	55,0 mm 2.165	36,0 1.417	53,0 2.087	8,0 0.315	140°	TiAlN	IT8-9
SD205A-0794-043-08R1-P	03046339	7,938 0.313	43,0 1.693	91,0 3.583	55,0 mm 2.165	36,0 1.417	53,0 2.087	8,0 0.315	140°	TiAlN	IT8-9
SD205A-0800-043-08R1-P	03046200	8,0 0.315	43,0 1.693	91,0 3.583	55,0 mm 2.165	36,0 1.417	53,0 2.087	8,0 0.315	140°	TiAlN	IT8-9
SD205A-0810-049-10R1-P	03046201	8,1 0.319	49,0 1.929	103,0 4.055	63,0 mm 2.480	40,0 1.575	61,0 2.402	10,0 0.394	140°	TiAlN	IT8-9
SD205A-0820-049-10R1-P	03046202	8,2 0.323	49,0 1.929	103,0 4.055	63,0 mm 2.480	40,0 1.575	61,0 2.402	10,0 0.394	140°	TiAlN	IT8-9
SD205A-0830-049-10R1-P	03046203	8,3 0.327	49,0 1.929	103,0 4.055	63,0 mm 2.480	40,0 1.575	61,0 2.402	10,0 0.394	140°	TiAlN	IT8-9

Introduzione

Foratura

Alesatura

Barenatura

Allegato

Codice di ordinazione	Codice prodotto	DC	LU	OAL	LFS	LS	LCF	DMM	Angolo di punta	Rivestimento	Tolleranza foro
		mm Inch	mm Inch	mm Inch	mm Inch	mm Inch	mm Inch	mm Inch			
SD205A-0833-049-10R1-P	03046340	8,334 0.328	49,0 1.929	103,0 4.055	63,0 mm 2.480	40,0 1.575	61,0 2.402	10,0 0.394	140°	TiAIN	IT8-9
SD205A-0840-049-10R1-P	03046204	8,4 0.331	49,0 1.929	103,0 4.055	63,0 mm 2.480	40,0 1.575	61,0 2.402	10,0 0.394	140°	TiAIN	IT8-9
SD205A-0850-049-10R1-P	03046205	8,5 0.335	49,0 1.929	103,0 4.055	63,0 mm 2.480	40,0 1.575	61,0 2.402	10,0 0.394	140°	TiAIN	IT8-9
SD205A-0860-049-10R1-P	03046206	8,6 0.339	49,0 1.929	103,0 4.055	63,0 mm 2.480	40,0 1.575	61,0 2.402	10,0 0.394	140°	TiAIN	IT8-9
SD205A-0870-049-10R1-P	03046207	8,7 0.343	49,0 1.929	103,0 4.055	63,0 mm 2.480	40,0 1.575	61,0 2.402	10,0 0.394	140°	TiAIN	IT8-9
SD205A-0873-049-10R1-P	03046341	8,731 0.344	49,0 1.929	103,0 4.055	63,0 mm 2.480	40,0 1.575	61,0 2.402	10,0 0.394	140°	TiAIN	IT8-9
SD205A-0880-049-10R1-P	03046208	8,8 0.346	49,0 1.929	103,0 4.055	63,0 mm 2.480	40,0 1.575	61,0 2.402	10,0 0.394	140°	TiAIN	IT8-9
SD205A-0890-049-10R1-P	03046209	8,9 0.350	49,0 1.929	103,0 4.055	63,0 mm 2.480	40,0 1.575	61,0 2.402	10,0 0.394	140°	TiAIN	IT8-9
SD205A-0900-049-10R1-P	03046210	9,0 0.354	49,0 1.929	103,0 4.055	63,0 mm 2.480	40,0 1.575	61,0 2.402	10,0 0.394	140°	TiAIN	IT8-9
SD205A-0910-049-10R1-P	03046211	9,1 0.358	49,0 1.929	103,0 4.055	63,0 mm 2.480	40,0 1.575	61,0 2.402	10,0 0.394	140°	TiAIN	IT8-9
SD205A-0913-049-10R1-P	03046342	9,128 0.359	49,0 1.929	103,0 4.055	63,0 mm 2.480	40,0 1.575	61,0 2.402	10,0 0.394	140°	TiAIN	IT8-9
SD205A-0920-049-10R1-P	03046212	9,2 0.362	49,0 1.929	103,0 4.055	63,0 mm 2.480	40,0 1.575	61,0 2.402	10,0 0.394	140°	TiAIN	IT8-9
SD205A-0930-049-10R1-P	03046213	9,3 0.366	49,0 1.929	103,0 4.055	63,0 mm 2.480	40,0 1.575	61,0 2.402	10,0 0.394	140°	TiAIN	IT8-9
SD205A-0940-049-10R1-P	03046214	9,4 0.370	49,0 1.929	103,0 4.055	63,0 mm 2.480	40,0 1.575	61,0 2.402	10,0 0.394	140°	TiAIN	IT8-9
SD205A-0950-049-10R1-P	03046215	9,5 0.374	49,0 1.929	103,0 4.055	63,0 mm 2.480	40,0 1.575	61,0 2.402	10,0 0.394	140°	TiAIN	IT8-9
SD205A-0953-049-10R1-P	03046343	9,525 0.375	49,0 1.929	103,0 4.055	63,0 mm 2.480	40,0 1.575	61,0 2.402	10,0 0.394	140°	TiAIN	IT8-9
SD205A-0955-049-10R1-P	03046216	9,55 0.376	49,0 1.929	103,0 4.055	63,0 mm 2.480	40,0 1.575	61,0 2.402	10,0 0.394	140°	TiAIN	IT8-9
SD205A-0960-049-10R1-P	03046217	9,6 0.378	49,0 1.929	103,0 4.055	63,0 mm 2.480	40,0 1.575	61,0 2.402	10,0 0.394	140°	TiAIN	IT8-9
SD205A-0970-049-10R1-P	03046218	9,7 0.382	49,0 1.929	103,0 4.055	63,0 mm 2.480	40,0 1.575	61,0 2.402	10,0 0.394	140°	TiAIN	IT8-9
SD205A-0980-049-10R1-P	03046219	9,8 0.386	49,0 1.929	103,0 4.055	63,0 mm 2.480	40,0 1.575	61,0 2.402	10,0 0.394	140°	TiAIN	IT8-9
SD205A-0990-049-10R1-P	03046220	9,9 0.390	49,0 1.929	103,0 4.055	63,0 mm 2.480	40,0 1.575	61,0 2.402	10,0 0.394	140°	TiAIN	IT8-9
SD205A-0992-049-10R1-P	03046344	9,922 0.391	49,0 1.929	103,0 4.055	63,0 mm 2.480	40,0 1.575	61,0 2.402	10,0 0.394	140°	TiAIN	IT8-9
SD205A-1000-049-10R1-P	03046221	10,0 0.394	49,0 1.929	103,0 4.055	63,0 mm 2.480	40,0 1.575	61,0 2.402	10,0 0.394	140°	TiAIN	IT8-9
SD205A-1010-056-12R1-P	03046222	10,1 0.398	56,0 2.205	118,0 4.646	73,0 mm 2.874	45,0 1.772	71,0 2.795	12,0 0.472	140°	TiAIN	IT8-9
SD205A-1020-056-12R1-P	03046223	10,2 0.402	56,0 2.205	118,0 4.646	73,0 mm 2.874	45,0 1.772	71,0 2.795	12,0 0.472	140°	TiAIN	IT8-9
SD205A-1030-056-12R1-P	03046224	10,3 0.406	56,0 2.205	118,0 4.646	73,0 mm 2.874	45,0 1.772	71,0 2.795	12,0 0.472	140°	TiAIN	IT8-9
SD205A-1032-056-12R1-P	03046345	10,319 0.406	56,0 2.205	118,0 4.646	73,0 mm 2.874	45,0 1.772	71,0 2.795	12,0 0.472	140°	TiAIN	IT8-9
SD205A-1040-056-12R1-P	03046225	10,4 0.409	56,0 2.205	118,0 4.646	73,0 mm 2.874	45,0 1.772	71,0 2.795	12,0 0.472	140°	TiAIN	IT8-9
SD205A-1050-056-12R1-P	03046226	10,5 0.413	56,0 2.205	118,0 4.646	73,0 mm 2.874	45,0 1.772	71,0 2.795	12,0 0.472	140°	TiAIN	IT8-9
SD205A-1060-056-12R1-P	03046227	10,6 0.417	56,0 2.205	118,0 4.646	73,0 mm 2.874	45,0 1.772	71,0 2.795	12,0 0.472	140°	TiAIN	IT8-9
SD205A-1070-056-12R1-P	03046228	10,7 0.421	56,0 2.205	118,0 4.646	73,0 mm 2.874	45,0 1.772	71,0 2.795	12,0 0.472	140°	TiAIN	IT8-9

Codice di ordinazione	Codice prodotto	DC	LU	OAL	LFS	LS	LCF	DMM	Angolo di punta	Rivestimento	Tolleranza foro
		mm Inch	mm Inch	mm Inch	mm Inch	mm Inch	mm Inch	mm Inch			
SD205A-1072-056-12R1-P	03046346	10,716 0.422	56,0 2.205	118,0 4.646	73,0 mm 2.874	45,0 1.772	71,0 2.795	12,0 0.472	140°	TiAlN	IT8-9
SD205A-1080-056-12R1-P	03046229	10,8 0.425	56,0 2.205	118,0 4.646	73,0 mm 2.874	45,0 1.772	71,0 2.795	12,0 0.472	140°	TiAlN	IT8-9
SD205A-1090-056-12R1-P	03046230	10,9 0.429	56,0 2.205	118,0 4.646	73,0 mm 2.874	45,0 1.772	71,0 2.795	12,0 0.472	140°	TiAlN	IT8-9
SD205A-1100-056-12R1-P	03046231	11,0 0.433	56,0 2.205	118,0 4.646	73,0 mm 2.874	45,0 1.772	71,0 2.795	12,0 0.472	140°	TiAlN	IT8-9
SD205A-1110-056-12R1-P	03046232	11,1 0.437	56,0 2.205	118,0 4.646	73,0 mm 2.874	45,0 1.772	71,0 2.795	12,0 0.472	140°	TiAlN	IT8-9
SD205A-1111-056-12R1-P	03046347	11,113 0.438	56,0 2.205	118,0 4.646	73,0 mm 2.874	45,0 1.772	71,0 2.795	12,0 0.472	140°	TiAlN	IT8-9
SD205A-1120-056-12R1-P	03046233	11,2 0.441	56,0 2.205	118,0 4.646	73,0 mm 2.874	45,0 1.772	71,0 2.795	12,0 0.472	140°	TiAlN	IT8-9
SD205A-1130-056-12R1-P	03046234	11,3 0.445	56,0 2.205	118,0 4.646	73,0 mm 2.874	45,0 1.772	71,0 2.795	12,0 0.472	140°	TiAlN	IT8-9
SD205A-1140-056-12R1-P	03046235	11,4 0.449	56,0 2.205	118,0 4.646	73,0 mm 2.874	45,0 1.772	71,0 2.795	12,0 0.472	140°	TiAlN	IT8-9
SD205A-1150-056-12R1-P	03046236	11,5 0.453	56,0 2.205	118,0 4.646	73,0 mm 2.874	45,0 1.772	71,0 2.795	12,0 0.472	140°	TiAlN	IT8-9
SD205A-1151-056-12R1-P	03046348	11,509 0.453	56,0 2.205	118,0 4.646	73,0 mm 2.874	45,0 1.772	71,0 2.795	12,0 0.472	140°	TiAlN	IT8-9
SD205A-1155-056-12R1-P	03046237	11,55 0.455	56,0 2.205	118,0 4.646	73,0 mm 2.874	45,0 1.772	71,0 2.795	12,0 0.472	140°	TiAlN	IT8-9
SD205A-1160-056-12R1-P	03046238	11,6 0.457	56,0 2.205	118,0 4.646	73,0 mm 2.874	45,0 1.772	71,0 2.795	12,0 0.472	140°	TiAlN	IT8-9
SD205A-1170-056-12R1-P	03046239	11,7 0.461	56,0 2.205	118,0 4.646	73,0 mm 2.874	45,0 1.772	71,0 2.795	12,0 0.472	140°	TiAlN	IT8-9
SD205A-1180-056-12R1-P	03046240	11,8 0.465	56,0 2.205	118,0 4.646	73,0 mm 2.874	45,0 1.772	71,0 2.795	12,0 0.472	140°	TiAlN	IT8-9
SD205A-1190-056-12R1-P	03046241	11,9 0.469	56,0 2.205	118,0 4.646	73,0 mm 2.874	45,0 1.772	71,0 2.795	12,0 0.472	140°	TiAlN	IT8-9
SD205A-1191-056-12R1-P	03046349	11,906 0.469	56,0 2.205	118,0 4.646	73,0 mm 2.874	45,0 1.772	71,0 2.795	12,0 0.472	140°	TiAlN	IT8-9
SD205A-1200-056-12R1-P	03046242	12,0 0.472	56,0 2.205	118,0 4.646	73,0 mm 2.874	45,0 1.772	71,0 2.795	12,0 0.472	140°	TiAlN	IT8-9
SD205A-1210-060-14R1-P	03046243	12,1 0.476	60,0 2.362	124,0 4.882	79,0 mm 3.110	45,0 1.772	77,0 3.031	14,0 0.551	140°	TiAlN	IT8-9
SD205A-1220-060-14R1-P	03046244	12,2 0.480	60,0 2.362	124,0 4.882	79,0 mm 3.110	45,0 1.772	77,0 3.031	14,0 0.551	140°	TiAlN	IT8-9
SD205A-1225-060-14R1-P	03046245	12,25 0.482	60,0 2.362	124,0 4.882	79,0 mm 3.110	45,0 1.772	77,0 3.031	14,0 0.551	140°	TiAlN	IT8-9
SD205A-1230-060-14R1-P	03138157	12,3 0.484	60,0 2.362	124,0 4.882	79,0 mm 3.110	45,0 1.772	77,0 3.031	14,0 0.551	140°	TiAlN	IT8-9
SD205A-1240-060-14R1-P	03046246	12,4 0.488	60,0 2.362	124,0 4.882	79,0 mm 3.110	45,0 1.772	77,0 3.031	14,0 0.551	140°	TiAlN	IT8-9
SD205A-1250-060-14R1-P	03046247	12,5 0.492	60,0 2.362	124,0 4.882	79,0 mm 3.110	45,0 1.772	77,0 3.031	14,0 0.551	140°	TiAlN	IT8-9
SD205A-1260-060-14R1-P	03046248	12,6 0.496	60,0 2.362	124,0 4.882	79,0 mm 3.110	45,0 1.772	77,0 3.031	14,0 0.551	140°	TiAlN	IT8-9
SD205A-1270-060-14R1-P	03120497	12,7 0.500	60,0 2.362	124,0 4.882	79,0 mm 3.110	45,0 1.772	77,0 3.031	14,0 0.551	140°	TiAlN	IT8-9
SD205A-1275-060-14R1-P	03046249	12,75 0.502	60,0 2.362	124,0 4.882	79,0 mm 3.110	45,0 1.772	77,0 3.031	14,0 0.551	140°	TiAlN	IT8-9
SD205A-1280-060-14R1-P	03046250	12,8 0.504	60,0 2.362	124,0 4.882	79,0 mm 3.110	45,0 1.772	77,0 3.031	14,0 0.551	140°	TiAlN	IT8-9
SD205A-1290-060-14R1-P	03046251	12,9 0.508	60,0 2.362	124,0 4.882	79,0 mm 3.110	45,0 1.772	77,0 3.031	14,0 0.551	140°	TiAlN	IT8-9
SD205A-1300-060-14R1-P	03046252	13,0 0.512	60,0 2.362	124,0 4.882	79,0 mm 3.110	45,0 1.772	77,0 3.031	14,0 0.551	140°	TiAlN	IT8-9
SD205A-1310-060-14R1-P	03046253	13,1 0.516	60,0 2.362	124,0 4.882	79,0 mm 3.110	45,0 1.772	77,0 3.031	14,0 0.551	140°	TiAlN	IT8-9

Introduzione

Foratura

Alesatura

Barenatura

Allegato

Codice di ordinazione	Codice prodotto	DC	LU	OAL	LFS	LS	LCF	DMM	Angolo di punta	Rivestimento	Tolleranza foro
		mm Inch	mm Inch	mm Inch	mm Inch	mm Inch	mm Inch	mm Inch			
SD205A-1320-060-14R1-P	03046254	13,2 0.520	60,0 2.362	124,0 4.882	79,0 mm 3.110	45,0 1.772	77,0 3.031	14,0 0.551	140°	TiAIN	IT8-9
SD205A-1330-060-14R1-P	03046255	13,3 0.524	60,0 2.362	124,0 4.882	79,0 mm 3.110	45,0 1.772	77,0 3.031	14,0 0.551	140°	TiAIN	IT8-9
SD205A-1340-060-14R1-P	03046256	13,4 0.528	60,0 2.362	124,0 4.882	79,0 mm 3.110	45,0 1.772	77,0 3.031	14,0 0.551	140°	TiAIN	IT8-9
SD205A-1349-060-14R1-P	03046350	13,494 0.531	60,0 2.362	124,0 4.882	79,0 mm 3.110	45,0 1.772	77,0 3.031	14,0 0.551	140°	TiAIN	IT8-9
SD205A-1350-060-14R1-P	03046257	13,5 0.531	60,0 2.362	124,0 4.882	79,0 mm 3.110	45,0 1.772	77,0 3.031	14,0 0.551	140°	TiAIN	IT8-9
SD205A-1355-060-14R1-P	03138158	13,55 0.533	60,0 2.362	124,0 4.882	79,0 mm 3.110	45,0 1.772	77,0 3.031	14,0 0.551	140°	TiAIN	IT8-9
SD205A-1360-060-14R1-P	03046258	13,6 0.535	60,0 2.362	124,0 4.882	79,0 mm 3.110	45,0 1.772	77,0 3.031	14,0 0.551	140°	TiAIN	IT8-9
SD205A-1370-060-14R1-P	03046259	13,7 0.539	60,0 2.362	124,0 4.882	79,0 mm 3.110	45,0 1.772	77,0 3.031	14,0 0.551	140°	TiAIN	IT8-9
SD205A-1380-060-14R1-P	03046260	13,8 0.543	60,0 2.362	124,0 4.882	79,0 mm 3.110	45,0 1.772	77,0 3.031	14,0 0.551	140°	TiAIN	IT8-9
SD205A-1389-060-14R1-P	03120498	13,891 0.547	60,0 2.362	124,0 4.882	79,0 mm 3.110	45,0 1.772	77,0 3.031	14,0 0.551	140°	TiAIN	IT8-9
SD205A-1390-060-14R1-P	03046261	13,9 0.547	60,0 2.362	124,0 4.882	79,0 mm 3.110	45,0 1.772	77,0 3.031	14,0 0.551	140°	TiAIN	IT8-9
SD205A-1400-060-14R1-P	03046262	14,0 0.551	60,0 2.362	124,0 4.882	79,0 mm 3.110	45,0 1.772	77,0 3.031	14,0 0.551	140°	TiAIN	IT8-9
SD205A-1410-063-16R1-P	03046263	14,1 0.555	63,0 2.480	133,0 5.236	85,0 mm 3.346	48,0 1.890	83,0 3.268	16,0 0.630	140°	TiAIN	IT8-9
SD205A-1420-063-16R1-P	03046264	14,2 0.559	63,0 2.480	133,0 5.236	85,0 mm 3.346	48,0 1.890	83,0 3.268	16,0 0.630	140°	TiAIN	IT8-9
SD205A-1425-063-16R1-P	03138159	14,25 0.561	63,0 2.480	133,0 5.236	85,0 mm 3.346	48,0 1.890	83,0 3.268	16,0 0.630	140°	TiAIN	IT8-9
SD205A-1429-063-16R1-P	03046351	14,288 0.563	63,0 2.480	133,0 5.236	85,0 mm 3.346	48,0 1.890	83,0 3.268	16,0 0.630	140°	TiAIN	IT8-9
SD205A-1430-063-16R1-P	03046265	14,3 0.563	63,0 2.480	133,0 5.236	85,0 mm 3.346	48,0 1.890	83,0 3.268	16,0 0.630	140°	TiAIN	IT8-9
SD205A-1440-063-16R1-P	03046266	14,4 0.567	63,0 2.480	133,0 5.236	85,0 mm 3.346	48,0 1.890	83,0 3.268	16,0 0.630	140°	TiAIN	IT8-9
SD205A-1450-063-16R1-P	03046267	14,5 0.571	63,0 2.480	133,0 5.236	85,0 mm 3.346	48,0 1.890	83,0 3.268	16,0 0.630	140°	TiAIN	IT8-9
SD205A-1460-063-16R1-P	03046268	14,6 0.575	63,0 2.480	133,0 5.236	85,0 mm 3.346	48,0 1.890	83,0 3.268	16,0 0.630	140°	TiAIN	IT8-9
SD205A-1470-063-16R1-P	03046269	14,7 0.579	63,0 2.480	133,0 5.236	85,0 mm 3.346	48,0 1.890	83,0 3.268	16,0 0.630	140°	TiAIN	IT8-9
SD205A-1475-063-16R1-P	03046270	14,75 0.581	63,0 2.480	133,0 5.236	85,0 mm 3.346	48,0 1.890	83,0 3.268	16,0 0.630	140°	TiAIN	IT8-9
SD205A-1480-063-16R1-P	03046271	14,8 0.583	63,0 2.480	133,0 5.236	85,0 mm 3.346	48,0 1.890	83,0 3.268	16,0 0.630	140°	TiAIN	IT8-9
SD205A-1490-063-16R1-P	03046272	14,9 0.587	63,0 2.480	133,0 5.236	85,0 mm 3.346	48,0 1.890	83,0 3.268	16,0 0.630	140°	TiAIN	IT8-9
SD205A-1500-063-16R1-P	03046273	15,0 0.591	63,0 2.480	133,0 5.236	85,0 mm 3.346	48,0 1.890	83,0 3.268	16,0 0.630	140°	TiAIN	IT8-9
SD205A-1510-063-16R1-P	03046274	15,1 0.594	63,0 2.480	133,0 5.236	85,0 mm 3.346	48,0 1.890	83,0 3.268	16,0 0.630	140°	TiAIN	IT8-9
SD205A-1520-063-16R1-P	03046275	15,2 0.598	63,0 2.480	133,0 5.236	85,0 mm 3.346	48,0 1.890	83,0 3.268	16,0 0.630	140°	TiAIN	IT8-9
SD205A-1525-063-16R1-P	03138160	15,25 0.600	63,0 2.480	133,0 5.236	85,0 mm 3.346	48,0 1.890	83,0 3.268	16,0 0.630	140°	TiAIN	IT8-9
SD205A-1530-063-16R1-P	03046276	15,3 0.602	63,0 2.480	133,0 5.236	85,0 mm 3.346	48,0 1.890	83,0 3.268	16,0 0.630	140°	TiAIN	IT8-9
SD205A-1540-063-16R1-P	03046277	15,4 0.606	63,0 2.480	133,0 5.236	85,0 mm 3.346	48,0 1.890	83,0 3.268	16,0 0.630	140°	TiAIN	IT8-9
SD205A-1550-063-16R1-P	03046278	15,5 0.610	63,0 2.480	133,0 5.236	85,0 mm 3.346	48,0 1.890	83,0 3.268	16,0 0.630	140°	TiAIN	IT8-9

Codice di ordinazione	Codice prodotto	DC	LU	OAL	LFS	LS	LCF	DMM	Angolo di punta	Rivestimento	Tolleranza foro
		mm Inch	mm Inch	mm Inch	mm Inch	mm Inch	mm Inch	mm Inch			
SD205A-1560-063-16R1-P	03046280	15,6 0.614	63,0 2.480	133,0 5.236	85,0 mm 3.346	48,0 1.890	83,0 3.268	16,0 0.630	140°	TiAlN	IT8-9
SD205A-1570-063-16R1-P	03046281	15,7 0.618	63,0 2.480	133,0 5.236	85,0 mm 3.346	48,0 1.890	83,0 3.268	16,0 0.630	140°	TiAlN	IT8-9
SD205A-1580-063-16R1-P	03046282	15,8 0.622	63,0 2.480	133,0 5.236	85,0 mm 3.346	48,0 1.890	83,0 3.268	16,0 0.630	140°	TiAlN	IT8-9
SD205A-1588-063-16R1-P	03046352	15,875 0.625	63,0 2.480	133,0 5.236	85,0 mm 3.346	48,0 1.890	83,0 3.268	16,0 0.630	140°	TiAlN	IT8-9
SD205A-1590-063-16R1-P	03046283	15,9 0.626	63,0 2.480	133,0 5.236	85,0 mm 3.346	48,0 1.890	83,0 3.268	16,0 0.630	140°	TiAlN	IT8-9
SD205A-1600-063-16R1-P	03046284	16,0 0.630	63,0 2.480	133,0 5.236	85,0 mm 3.346	48,0 1.890	83,0 3.268	16,0 0.630	140°	TiAlN	IT8-9
SD205A-1610-071-18R1-P	03046285	16,1 0.634	71,0 2.795	143,0 5.630	95,0 mm 3.740	48,0 1.890	93,0 3.661	18,0 0.709	140°	TiAlN	IT8-9
SD205A-1620-071-18R1-P	03046286	16,2 0.638	71,0 2.795	143,0 5.630	95,0 mm 3.740	48,0 1.890	93,0 3.661	18,0 0.709	140°	TiAlN	IT8-9
SD205A-1625-071-18R1-P	03138161	16,25 0.640	71,0 2.795	143,0 5.630	95,0 mm 3.740	48,0 1.890	93,0 3.661	18,0 0.709	140°	TiAlN	IT8-9
SD205A-1630-071-18R1-P	03046287	16,3 0.642	71,0 2.795	143,0 5.630	95,0 mm 3.740	48,0 1.890	93,0 3.661	18,0 0.709	140°	TiAlN	IT8-9
SD205A-1640-071-18R1-P	03046288	16,4 0.646	71,0 2.795	143,0 5.630	95,0 mm 3.740	48,0 1.890	93,0 3.661	18,0 0.709	140°	TiAlN	IT8-9
SD205A-1650-071-18R1-P	03046289	16,5 0.650	71,0 2.795	143,0 5.630	95,0 mm 3.740	48,0 1.890	93,0 3.661	18,0 0.709	140°	TiAlN	IT8-9
SD205A-1660-071-18R1-P	03046290	16,6 0.654	71,0 2.795	143,0 5.630	95,0 mm 3.740	48,0 1.890	93,0 3.661	18,0 0.709	140°	TiAlN	IT8-9
SD205A-1667-071-18R1-P	03120499	16,669 0.656	71,0 2.795	143,0 5.630	95,0 mm 3.740	48,0 1.890	93,0 3.661	18,0 0.709	140°	TiAlN	IT8-9
SD205A-1670-071-18R1-P	03046291	16,7 0.657	71,0 2.795	143,0 5.630	95,0 mm 3.740	48,0 1.890	93,0 3.661	18,0 0.709	140°	TiAlN	IT8-9
SD205A-1675-071-18R1-P	03046292	16,75 0.659	71,0 2.795	143,0 5.630	95,0 mm 3.740	48,0 1.890	93,0 3.661	18,0 0.709	140°	TiAlN	IT8-9
SD205A-1680-071-18R1-P	03046293	16,8 0.661	71,0 2.795	143,0 5.630	95,0 mm 3.740	48,0 1.890	93,0 3.661	18,0 0.709	140°	TiAlN	IT8-9
SD205A-1690-071-18R1-P	03046294	16,9 0.665	71,0 2.795	143,0 5.630	95,0 mm 3.740	48,0 1.890	93,0 3.661	18,0 0.709	140°	TiAlN	IT8-9
SD205A-1700-071-18R1-P	03046296	17,0 0.669	71,0 2.795	143,0 5.630	95,0 mm 3.740	48,0 1.890	93,0 3.661	18,0 0.709	140°	TiAlN	IT8-9
SD205A-1710-071-18R1-P	03046297	17,1 0.673	71,0 2.795	143,0 5.630	95,0 mm 3.740	48,0 1.890	93,0 3.661	18,0 0.709	140°	TiAlN	IT8-9
SD205A-1720-071-18R1-P	03046298	17,2 0.677	71,0 2.795	143,0 5.630	95,0 mm 3.740	48,0 1.890	93,0 3.661	18,0 0.709	140°	TiAlN	IT8-9
SD205A-1730-071-18R1-P	03046299	17,3 0.681	71,0 2.795	143,0 5.630	95,0 mm 3.740	48,0 1.890	93,0 3.661	18,0 0.709	140°	TiAlN	IT8-9
SD205A-1740-071-18R1-P	03046300	17,4 0.685	71,0 2.795	143,0 5.630	95,0 mm 3.740	48,0 1.890	93,0 3.661	18,0 0.709	140°	TiAlN	IT8-9
SD205A-1746-071-18R1-P	03120500	17,463 0.688	71,0 2.795	143,0 5.630	95,0 mm 3.740	48,0 1.890	93,0 3.661	18,0 0.709	140°	TiAlN	IT8-9
SD205A-1750-071-18R1-P	03046301	17,5 0.689	71,0 2.795	143,0 5.630	95,0 mm 3.740	48,0 1.890	93,0 3.661	18,0 0.709	140°	TiAlN	IT8-9
SD205A-1760-071-18R1-P	03046302	17,6 0.693	71,0 2.795	143,0 5.630	95,0 mm 3.740	48,0 1.890	93,0 3.661	18,0 0.709	140°	TiAlN	IT8-9
SD205A-1770-071-18R1-P	03046303	17,7 0.697	71,0 2.795	143,0 5.630	95,0 mm 3.740	48,0 1.890	93,0 3.661	18,0 0.709	140°	TiAlN	IT8-9
SD205A-1780-071-18R1-P	03046304	17,8 0.701	71,0 2.795	143,0 5.630	95,0 mm 3.740	48,0 1.890	93,0 3.661	18,0 0.709	140°	TiAlN	IT8-9
SD205A-1790-071-18R1-P	03046305	17,9 0.705	71,0 2.795	143,0 5.630	95,0 mm 3.740	48,0 1.890	93,0 3.661	18,0 0.709	140°	TiAlN	IT8-9
SD205A-1800-071-18R1-P	03046306	18,0 0.709	71,0 2.795	143,0 5.630	95,0 mm 3.740	48,0 1.890	93,0 3.661	18,0 0.709	140°	TiAlN	IT8-9
SD205A-1810-077-20R1-P	03046307	18,1 0.713	77,0 3.031	153,0 6.024	103,0 mm 4.055	50,0 1.969	101,0 3.976	20,0 0.787	140°	TiAlN	IT8-9

Introduzione

Foratura

Alesatura

Barenatura

Allegato

Codice di ordinazione	Codice prodotto	DC	LU	OAL	LFS	LS	LCF	DMM	Angolo di punta	Rivestimento	Tolleranza foro
		mm Inch	mm Inch	mm Inch	mm Inch	mm Inch	mm Inch	mm Inch			
SD205A-1820-077-20R1-P	03046308	18,2 0.717	77,0 3.031	153,0 6.024	103,0 mm 4.055	50,0 1.969	101,0 3.976	20,0 0.787	140°	TiAIN	IT8-9
SD205A-1830-077-20R1-P	03046309	18,3 0.720	77,0 3.031	153,0 6.024	103,0 mm 4.055	50,0 1.969	101,0 3.976	20,0 0.787	140°	TiAIN	IT8-9
SD205A-1840-077-20R1-P	03046310	18,4 0.724	77,0 3.031	153,0 6.024	103,0 mm 4.055	50,0 1.969	101,0 3.976	20,0 0.787	140°	TiAIN	IT8-9
SD205A-1850-077-20R1-P	03046311	18,5 0.728	77,0 3.031	153,0 6.024	103,0 mm 4.055	50,0 1.969	101,0 3.976	20,0 0.787	140°	TiAIN	IT8-9
SD205A-1860-077-20R1-P	03046312	18,6 0.732	77,0 3.031	153,0 6.024	103,0 mm 4.055	50,0 1.969	101,0 3.976	20,0 0.787	140°	TiAIN	IT8-9
SD205A-1870-077-20R1-P	03046313	18,7 0.736	77,0 3.031	153,0 6.024	103,0 mm 4.055	50,0 1.969	101,0 3.976	20,0 0.787	140°	TiAIN	IT8-9
SD205A-1880-077-20R1-P	03046314	18,8 0.740	77,0 3.031	153,0 6.024	103,0 mm 4.055	50,0 1.969	101,0 3.976	20,0 0.787	140°	TiAIN	IT8-9
SD205A-1890-077-20R1-P	03046315	18,9 0.744	77,0 3.031	153,0 6.024	103,0 mm 4.055	50,0 1.969	101,0 3.976	20,0 0.787	140°	TiAIN	IT8-9
SD205A-1900-077-20R1-P	03046316	19,0 0.748	77,0 3.031	153,0 6.024	103,0 mm 4.055	50,0 1.969	101,0 3.976	20,0 0.787	140°	TiAIN	IT8-9
SD205A-1905-077-20R1-P	03046353	19,05 0.750	77,0 3.031	153,0 6.024	103,0 mm 4.055	50,0 1.969	101,0 3.976	20,0 0.787	140°	TiAIN	IT8-9
SD205A-1910-077-20R1-P	03046317	19,1 0.752	77,0 3.031	153,0 6.024	103,0 mm 4.055	50,0 1.969	101,0 3.976	20,0 0.787	140°	TiAIN	IT8-9
SD205A-1920-077-20R1-P	03046318	19,2 0.756	77,0 3.031	153,0 6.024	103,0 mm 4.055	50,0 1.969	101,0 3.976	20,0 0.787	140°	TiAIN	IT8-9
SD205A-1930-077-20R1-P	03046319	19,3 0.760	77,0 3.031	153,0 6.024	103,0 mm 4.055	50,0 1.969	101,0 3.976	20,0 0.787	140°	TiAIN	IT8-9
SD205A-1940-077-20R1-P	03046320	19,4 0.764	77,0 3.031	153,0 6.024	103,0 mm 4.055	50,0 1.969	101,0 3.976	20,0 0.787	140°	TiAIN	IT8-9
SD205A-1950-077-20R1-P	03046321	19,5 0.768	77,0 3.031	153,0 6.024	103,0 mm 4.055	50,0 1.969	101,0 3.976	20,0 0.787	140°	TiAIN	IT8-9
SD205A-1960-077-20R1-P	03046322	19,6 0.772	77,0 3.031	153,0 6.024	103,0 mm 4.055	50,0 1.969	101,0 3.976	20,0 0.787	140°	TiAIN	IT8-9
SD205A-1970-077-20R1-P	03046323	19,7 0.776	77,0 3.031	153,0 6.024	103,0 mm 4.055	50,0 1.969	101,0 3.976	20,0 0.787	140°	TiAIN	IT8-9
SD205A-1980-077-20R1-P	03046324	19,8 0.780	77,0 3.031	153,0 6.024	103,0 mm 4.055	50,0 1.969	101,0 3.976	20,0 0.787	140°	TiAIN	IT8-9
SD205A-1990-077-20R1-P	03046325	19,9 0.783	77,0 3.031	153,0 6.024	103,0 mm 4.055	50,0 1.969	101,0 3.976	20,0 0.787	140°	TiAIN	IT8-9
SD205A-2000-077-20R1-P	03046326	20,0 0.787	77,0 3.031	153,0 6.024	103,0 mm 4.055	50,0 1.969	101,0 3.976	20,0 0.787	140°	TiAIN	IT8-9

Introduzione

Foratura

Alesatura

Barenatura

Allegato

SD206

Profondità di foratura ~ 6 x D – Misure metriche/Pollici

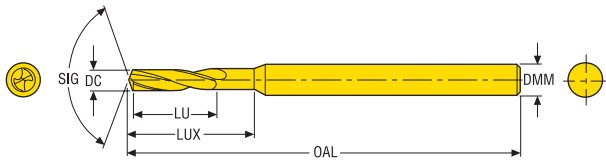

- Codolo cilindrico
- Adduzione refrigerante esterna
- Per i parametri di taglio raccomandati, vedere pagina(e) 149

Codice di ordinazione	Codice prodotto	DC	LU	OAL	LUX	DMM	Angolo di punta	Rivestimento	Tolleranza foro
		mm Inch	mm Inch	mm Inch	mm Inch	mm Inch			
SD206-0.70-4.2-3R1	02731644	0,7 0.028	4,2 0.165	38,0 1.496	6,0 0.236	3,0 0.118	140°	TiAIN	IT9
SD206-0.80-4.8-3R1	02731645	0,8 0.031	4,8 0.189	38,0 1.496	6,7 0.264	3,0 0.118	140°	TiAIN	IT9
SD206-0.90-5.4-3R1	02731646	0,9 0.035	5,4 0.213	38,0 1.496	7,8 0.307	3,0 0.118	140°	TiAIN	IT9
SD206-1.00-6.0-3R1	02731647	1,0 0.039	6,0 0.236	38,0 1.496	8,0 0.315	3,0 0.118	140°	TiAIN	IT9
SD206-1.10-6.6-3R1	02731648	1,1 0.043	6,6 0.260	38,0 1.496	8,6 0.339	3,0 0.118	140°	TiAIN	IT9
SD206-1.20-7.2-3R1	02731649	1,2 0.047	7,2 0.283	38,0 1.496	9,2 0.362	3,0 0.118	140°	TiAIN	IT9
SD206-1.30-7.8-3R1	02731650	1,3 0.051	7,8 0.307	38,0 1.496	9,8 0.386	3,0 0.118	140°	TiAIN	IT9
SD206-1.40-8.4-3R1	02731651	1,4 0.055	8,4 0.331	38,0 1.496	10,4 0.409	3,0 0.118	140°	TiAIN	IT9
SD206-1.50-9.0-3R1	02731652	1,5 0.059	9,0 0.354	38,0 1.496	11,0 0.433	3,0 0.118	140°	TiAIN	IT9
SD206-1.60-9.6-3R1	02731653	1,6 0.063	9,6 0.378	38,0 1.496	11,6 0.457	3,0 0.118	140°	TiAIN	IT9
SD206-1.70-10.2-3R1	02731654	1,7 0.067	10,2 0.402	38,0 1.496	12,2 0.480	3,0 0.118	140°	TiAIN	IT9
SD206-1.80-10.8-3R1	02731655	1,8 0.071	10,8 0.425	38,0 1.496	12,8 0.504	3,0 0.118	140°	TiAIN	IT9
SD206-1.90-11.4-3R1	02731656	1,9 0.075	11,4 0.449	38,0 1.496	13,4 0.528	3,0 0.118	140°	TiAIN	IT9
SD206-2.00-12.0-3R1	02731657	2,0 0.079	12,0 0.472	50,0 1.969	14,0 0.551	3,0 0.118	140°	TiAIN	IT9

SD206A

Profondità di foratura ~ 6 x D – Misure metriche/Pollici

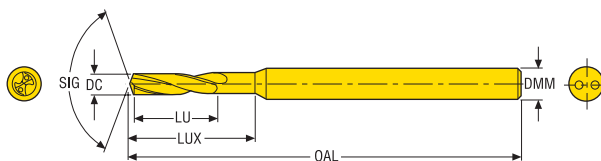

- Codolo cilindrico
- Adduzione refrigerante interna
- Per i parametri di taglio raccomandati, vedere pagina(e) 150

Codice di ordinazione	Codice prodotto	DC	LU	OAL	LUX	DMM	Angolo di punta	Rivestimento	Tolleranza foro
		mm Inch	mm Inch	mm Inch	mm Inch	mm Inch			
SD206A-1.00-6.0-3R1	02731658	1,0 0.039	6,0 0.236	38,0 1.496	8,0 0.315	3,0 0.118	140°	TiAIN	IT9
SD206A-1.10-6.6-3R1	02731659	1,1 0.043	6,6 0.260	38,0 1.496	8,6 0.339	3,0 0.118	140°	TiAIN	IT9
SD206A-1.20-7.2-3R1	02731660	1,2 0.047	7,2 0.283	38,0 1.496	9,2 0.362	3,0 0.118	140°	TiAIN	IT9
SD206A-1.30-7.8-3R1	02731661	1,3 0.051	7,8 0.307	38,0 1.496	9,8 0.386	3,0 0.118	140°	TiAIN	IT9
SD206A-1.40-8.4-3R1	02731662	1,4 0.055	8,4 0.331	38,0 1.496	10,4 0.409	3,0 0.118	140°	TiAIN	IT9
SD206A-1.50-9.0-3R1	02731663	1,5 0.059	9,0 0.354	38,0 1.496	11,0 0.433	3,0 0.118	140°	TiAIN	IT9
SD206A-1.60-9.6-3R1	02731664	1,6 0.063	9,6 0.378	38,0 1.496	11,6 0.457	3,0 0.118	140°	TiAIN	IT9
SD206A-1.70-10.2-3R1	02731665	1,7 0.067	10,2 0.402	38,0 1.496	12,2 0.480	3,0 0.118	140°	TiAIN	IT9
SD206A-1.80-10.8-3R1	02731666	1,8 0.071	10,8 0.425	38,0 1.496	12,8 0.504	3,0 0.118	140°	TiAIN	IT9
SD206A-1.90-11.4-3R1	02731667	1,9 0.075	11,4 0.449	38,0 1.496	13,4 0.528	3,0 0.118	140°	TiAIN	IT9
SD206A-2.00-12.0-3R1	02731668	2,0 0.079	12,0 0.472	50,0 1.969	14,0 0.551	3,0 0.118	140°	TiAIN	IT9

Introduzione

Foratura

Alesatura

Barenatura

Allegato

SD207A-P

Profondità di foratura ~ 7 x D – Misure metriche/Pollici

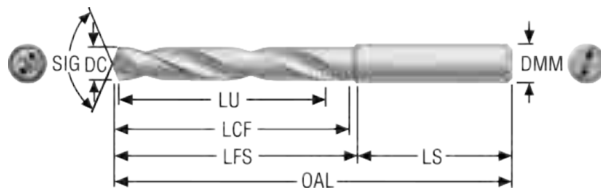

- Codolo cilindrico DIN 6537A
- Adduzione refrigerante interna
- Per i parametri di taglio raccomandati, vedere pagina(e) 151
- Per i diametri intermedi, utilizzare MyDesign.

Codice di ordinazione	Codice prodotto	DC	LU	OAL	LFS	LS	LCF	DMM	Angolo di punta	Rivestimento	Tolleranza foro
		mm Inch	mm Inch	mm Inch	mm Inch	mm Inch	mm Inch	mm Inch			
SD207A-0300-030-06R1-P	03046358	3,0 0.118	30,0 1.181	74,0 2.913	38,0 1.496	36,0 1.417	36,0 1.417	6,0 0.236	140°	TiAlN	IT9
SD207A-0330-030-06R1-P	03046359	3,3 0.130	30,0 1.181	74,0 2.913	38,0 1.496	36,0 1.417	36,0 1.417	6,0 0.236	140°	TiAlN	IT9
SD207A-0350-030-06R1-P	03046360	3,5 0.138	30,0 1.181	74,0 2.913	38,0 1.496	36,0 1.417	36,0 1.417	6,0 0.236	140°	TiAlN	IT9
SD207A-0400-037-06R1-P	03046361	4,0 0.157	37,0 1.457	82,0 3.228	46,0 1.811	36,0 1.417	43,0 1.693	6,0 0.236	140°	TiAlN	IT9
SD207A-0450-037-06R1-P	03046412	4,5 0.177	37,0 1.457	82,0 3.228	46,0 1.811	36,0 1.417	43,0 1.693	6,0 0.236	140°	TiAlN	IT9
SD207A-0480-045-06R1-P	03046413	4,8 0.189	45,0 1.772	94,0 3.701	58,0 2.283	36,0 1.417	56,0 2.205	6,0 0.236	140°	TiAlN	IT9
SD207A-0500-045-06R1-P	03046414	5,0 0.197	45,0 1.772	94,0 3.701	58,0 2.283	36,0 1.417	56,0 2.205	6,0 0.236	140°	TiAlN	IT9
SD207A-0520-045-06R1-P	03046362	5,2 0.205	45,0 1.772	94,0 3.701	58,0 2.283	36,0 1.417	56,0 2.205	6,0 0.236	140°	TiAlN	IT9
SD207A-0550-045-06R1-P	03046363	5,5 0.217	45,0 1.772	94,0 3.701	58,0 2.283	36,0 1.417	56,0 2.205	6,0 0.236	140°	TiAlN	IT9
SD207A-0580-045-06R1-P	03046407	5,8 0.228	45,0 1.772	94,0 3.701	58,0 2.283	36,0 1.417	56,0 2.205	6,0 0.236	140°	TiAlN	IT9
SD207A-0600-045-06R1-P	03046364	6,0 0.236	45,0 1.772	94,0 3.701	58,0 2.283	36,0 1.417	56,0 2.205	6,0 0.236	140°	TiAlN	IT9
SD207A-0635-057-08R1-P	03046365	6,35 0.250	57,0 2.244	110,0 4.331	74,0 2.913	36,0 1.417	67,0 2.638	8,0 0.315	140°	TiAlN	IT9
SD207A-0650-057-08R1-P	03046366	6,5 0.256	57,0 2.244	110,0 4.331	74,0 2.913	36,0 1.417	67,0 2.638	8,0 0.315	140°	TiAlN	IT9
SD207A-0680-057-08R1-P	03046367	6,8 0.268	57,0 2.244	110,0 4.331	74,0 2.913	36,0 1.417	67,0 2.638	8,0 0.315	140°	TiAlN	IT9
SD207A-0690-057-08R1-P	03046368	6,9 0.272	57,0 2.244	110,0 4.331	74,0 2.913	36,0 1.417	67,0 2.638	8,0 0.315	140°	TiAlN	IT9
SD207A-0700-057-08R1-P	03046369	7,0 0.276	57,0 2.244	110,0 4.331	74,0 2.913	36,0 1.417	67,0 2.638	8,0 0.315	140°	TiAlN	IT9
SD207A-0750-057-08R1-P	03046370	7,5 0.295	57,0 2.244	110,0 4.331	74,0 2.913	36,0 1.417	72,0 2.835	8,0 0.315	140°	TiAlN	IT9
SD207A-0780-057-08R1-P	03046371	7,8 0.307	57,0 2.244	110,0 4.331	74,0 2.913	36,0 1.417	72,0 2.835	8,0 0.315	140°	TiAlN	IT9
SD207A-0800-057-08R1-P	03046372	8,0 0.315	57,0 2.244	110,0 4.331	74,0 2.913	36,0 1.417	72,0 2.835	8,0 0.315	140°	TiAlN	IT9
SD207A-0850-062-10R1-P	03046373	8,5 0.335	62,0 2.441	122,0 4.803	82,0 3.228	40,0 1.575	80,0 3.150	10,0 0.394	140°	TiAlN	IT9
SD207A-0860-062-10R1-P	03046374	8,6 0.339	62,0 2.441	122,0 4.803	82,0 3.228	40,0 1.575	80,0 3.150	10,0 0.394	140°	TiAlN	IT9
SD207A-0870-062-10R1-P	03046411	8,7 0.343	62,0 2.441	122,0 4.803	82,0 3.228	40,0 1.575	80,0 3.150	10,0 0.394	140°	TiAlN	IT9

Codice di ordinazione	Codice prodotto	DC	LU	OAL	LFS	LS	LCF	DMM	Angolo di punta	Rivestimento	Tolleranza foro
		mm Inch	mm Inch	mm Inch	mm Inch	mm Inch	mm Inch	mm Inch			
SD207A-0880-062-10R1-P	03046408	8,8 0.346	62,0 2.441	122,0 4.803	82,0 3.228	40,0 1.575	80,0 3.150	10,0 0.394	140°	TiAIN	IT9
SD207A-0900-062-10R1-P	03046375	9,0 0.354	62,0 2.441	122,0 4.803	82,0 3.228	40,0 1.575	80,0 3.150	10,0 0.394	140°	TiAIN	IT9
SD207A-0950-062-10R1-P	03046376	9,5 0.374	62,0 2.441	122,0 4.803	82,0 3.228	40,0 1.575	80,0 3.150	10,0 0.394	140°	TiAIN	IT9
SD207A-0953-062-10R1-P	03046377	9,525 0.375	62,0 2.441	122,0 4.803	82,0 3.228	40,0 1.575	80,0 3.150	10,0 0.394	140°	TiAIN	IT9
SD207A-0975-062-10R1-P	03046402	9,75 0.384	62,0 2.441	122,0 4.803	82,0 3.228	40,0 1.575	80,0 3.150	10,0 0.394	140°	TiAIN	IT9
SD207A-0980-062-10R1-P	03046403	9,8 0.386	62,0 2.441	122,0 4.803	82,0 3.228	40,0 1.575	80,0 3.150	10,0 0.394	140°	TiAIN	IT9
SD207A-1000-062-10R1-P	03046378	10,0 0.394	62,0 2.441	122,0 4.803	82,0 3.228	40,0 1.575	80,0 3.150	10,0 0.394	140°	TiAIN	IT9
SD207A-1020-072-12R1-P	03046379	10,2 0.402	72,0 2.835	141,0 5.551	96,0 3.780	45,0 1.772	94,0 3.701	12,0 0.472	140°	TiAIN	IT9
SD207A-1040-072-12R1-P	03046401	10,4 0.409	72,0 2.835	141,0 5.551	96,0 3.780	45,0 1.772	94,0 3.701	12,0 0.472	140°	TiAIN	IT9
SD207A-1050-072-12R1-P	03046380	10,5 0.413	72,0 2.835	141,0 5.551	96,0 3.780	45,0 1.772	94,0 3.701	12,0 0.472	140°	TiAIN	IT9
SD207A-1080-072-12R1-P	03046404	10,8 0.425	72,0 2.835	141,0 5.551	96,0 3.780	45,0 1.772	94,0 3.701	12,0 0.472	140°	TiAIN	IT9
SD207A-1100-072-12R1-P	03046381	11,0 0.433	72,0 2.835	141,0 5.551	96,0 3.780	45,0 1.772	94,0 3.701	12,0 0.472	140°	TiAIN	IT9
SD207A-1150-072-12R1-P	03046382	11,5 0.453	72,0 2.835	141,0 5.551	96,0 3.780	45,0 1.772	94,0 3.701	12,0 0.472	140°	TiAIN	IT9
SD207A-1180-072-12R1-P	03046405	11,8 0.465	72,0 2.835	141,0 5.551	96,0 3.780	45,0 1.772	94,0 3.701	12,0 0.472	140°	TiAIN	IT9
SD207A-1200-072-12R1-P	03046383	12,0 0.472	72,0 2.835	141,0 5.551	96,0 3.780	45,0 1.772	94,0 3.701	12,0 0.472	140°	TiAIN	IT9
SD207A-1225-083-14R1-P	03046415	12,25 0.482	83,0 3.268	155,0 6.102	110,0 4.331	45,0 1.772	108,0 4.252	14,0 0.551	140°	TiAIN	IT9
SD207A-1250-083-14R1-P	03046384	12,5 0.492	83,0 3.268	155,0 6.102	110,0 4.331	45,0 1.772	108,0 4.252	14,0 0.551	140°	TiAIN	IT9
SD207A-1270-083-14R1-P	03046385	12,7 0.500	83,0 3.268	155,0 6.102	110,0 4.331	45,0 1.772	108,0 4.252	14,0 0.551	140°	TiAIN	IT9
SD207A-1280-083-14R1-P	03046416	12,8 0.504	83,0 3.268	155,0 6.102	110,0 4.331	45,0 1.772	108,0 4.252	14,0 0.551	140°	TiAIN	IT9
SD207A-1300-083-14R1-P	03046386	13,0 0.512	83,0 3.268	155,0 6.102	110,0 4.331	45,0 1.772	108,0 4.252	14,0 0.551	140°	TiAIN	IT9
SD207A-1350-083-14R1-P	03046387	13,5 0.531	83,0 3.268	155,0 6.102	110,0 4.331	45,0 1.772	108,0 4.252	14,0 0.551	140°	TiAIN	IT9
SD207A-1380-083-14R1-P	03046409	13,8 0.543	83,0 3.268	155,0 6.102	110,0 4.331	45,0 1.772	108,0 4.252	14,0 0.551	140°	TiAIN	IT9
SD207A-1400-083-14R1-P	03046388	14,0 0.551	83,0 3.268	155,0 6.102	110,0 4.331	45,0 1.772	108,0 4.252	14,0 0.551	140°	TiAIN	IT9
SD207A-1425-092-16R1-P	03046417	14,25 0.561	92,0 3.622	171,0 6.732	123,0 4.843	48,0 1.890	121,0 4.764	16,0 0.630	140°	TiAIN	IT9
SD207A-1450-092-16R1-P	03046389	14,5 0.571	92,0 3.622	171,0 6.732	123,0 4.843	48,0 1.890	121,0 4.764	16,0 0.630	140°	TiAIN	IT9
SD207A-1480-092-16R1-P	03046418	14,8 0.583	92,0 3.622	171,0 6.732	123,0 4.843	48,0 1.890	121,0 4.764	16,0 0.630	140°	TiAIN	IT9
SD207A-1500-092-16R1-P	03046390	15,0 0.591	92,0 3.622	171,0 6.732	123,0 4.843	48,0 1.890	121,0 4.764	16,0 0.630	140°	TiAIN	IT9
SD207A-1550-092-16R1-P	03046391	15,5 0.610	92,0 3.622	171,0 6.732	123,0 4.843	48,0 1.890	121,0 4.764	16,0 0.630	140°	TiAIN	IT9
SD207A-1580-092-16R1-P	03046410	15,8 0.622	92,0 3.622	171,0 6.732	123,0 4.843	48,0 1.890	121,0 4.764	16,0 0.630	140°	TiAIN	IT9
SD207A-1600-092-16R1-P	03046392	16,0 0.630	92,0 3.622	171,0 6.732	123,0 4.843	48,0 1.890	121,0 4.764	16,0 0.630	140°	TiAIN	IT9
SD207A-1650-103-18R1-P	03046393	16,5 0.650	103,0 4.055	185,0 7.283	137,0 5.394	48,0 1.890	135,0 5.315	18,0 0.709	140°	TiAIN	IT9

Codice di ordinazione	Codice prodotto	DC	LU	OAL	LFS	LS	LCF	DMM	Angolo di punta	Rivestimento	Tolleranza foro
		mm <i>Inch</i>	mm <i>Inch</i>	mm <i>Inch</i>	mm <i>Inch</i>	mm <i>Inch</i>	mm <i>Inch</i>	mm <i>Inch</i>			
SD207A-1680-103-18R1-P	03046419	16,8 <i>0.661</i>	103,0 <i>4.055</i>	185,0 <i>7.283</i>	137,0 <i>5.394</i>	48,0 <i>1.890</i>	135,0 <i>5.315</i>	18,0 <i>0.709</i>	140°	TiAIN	IT9
SD207A-1700-103-18R1-P	03046394	17,0 <i>0.669</i>	103,0 <i>4.055</i>	185,0 <i>7.283</i>	137,0 <i>5.394</i>	48,0 <i>1.890</i>	135,0 <i>5.315</i>	18,0 <i>0.709</i>	140°	TiAIN	IT9
SD207A-1750-103-18R1-P	03046395	17,5 <i>0.689</i>	103,0 <i>4.055</i>	185,0 <i>7.283</i>	137,0 <i>5.394</i>	48,0 <i>1.890</i>	135,0 <i>5.315</i>	18,0 <i>0.709</i>	140°	TiAIN	IT9
SD207A-1780-103-18R1-P	03046420	17,8 <i>0.701</i>	103,0 <i>4.055</i>	185,0 <i>7.283</i>	137,0 <i>5.394</i>	48,0 <i>1.890</i>	135,0 <i>5.315</i>	18,0 <i>0.709</i>	140°	TiAIN	IT9
SD207A-1800-103-18R1-P	03046396	18,0 <i>0.709</i>	103,0 <i>4.055</i>	185,0 <i>7.283</i>	137,0 <i>5.394</i>	48,0 <i>1.890</i>	135,0 <i>5.315</i>	18,0 <i>0.709</i>	140°	TiAIN	IT9
SD207A-1850-112-20R1-P	03046397	18,5 <i>0.728</i>	112,0 <i>4.409</i>	200,0 <i>7.874</i>	150,0 <i>5.906</i>	50,0 <i>1.969</i>	148,0 <i>5.827</i>	20,0 <i>0.787</i>	140°	TiAIN	IT9
SD207A-1880-112-20R1-P	03046421	18,8 <i>0.740</i>	112,0 <i>4.409</i>	200,0 <i>7.874</i>	150,0 <i>5.906</i>	50,0 <i>1.969</i>	148,0 <i>5.827</i>	20,0 <i>0.787</i>	140°	TiAIN	IT9
SD207A-1900-112-20R1-P	03046398	19,0 <i>0.748</i>	112,0 <i>4.409</i>	200,0 <i>7.874</i>	150,0 <i>5.906</i>	50,0 <i>1.969</i>	148,0 <i>5.827</i>	20,0 <i>0.787</i>	140°	TiAIN	IT9
SD207A-1905-112-20R1-P	03046399	19,05 <i>0.750</i>	112,0 <i>4.409</i>	200,0 <i>7.874</i>	150,0 <i>5.906</i>	50,0 <i>1.969</i>	148,0 <i>5.827</i>	20,0 <i>0.787</i>	140°	TiAIN	IT9
SD207A-1980-112-20R1-P	03046406	19,8 <i>0.780</i>	112,0 <i>4.409</i>	200,0 <i>7.874</i>	150,0 <i>5.906</i>	50,0 <i>1.969</i>	148,0 <i>5.827</i>	20,0 <i>0.787</i>	140°	TiAIN	IT9
SD207A-2000-112-20R1-P	03046400	20,0 <i>0.787</i>	112,0 <i>4.409</i>	200,0 <i>7.874</i>	150,0 <i>5.906</i>	50,0 <i>1.969</i>	148,0 <i>5.827</i>	20,0 <i>0.787</i>	140°	TiAIN	IT9

Introduzione

Foratura

Alesatura

Barenatura

Allegato

SD216A

Profondità di foratura ~ 16 x D – Misure metriche/Pollici

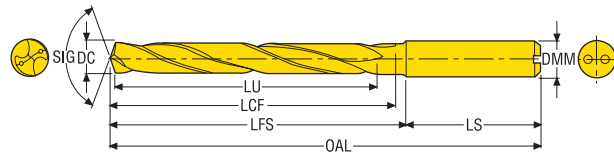

- Codolo cilindrico DIN 6537A
- Adduzione refrigerante interna
- Per i parametri di taglio raccomandati, vedere pagina(e) 152
- Per i diametri intermedi, utilizzare MyDesign.

Codice di ordinazione	Codice prodotto	DC	LU	OAL	LFS	LS	LCF	DMM	Angolo di punta Rivestimento	Tolleranza foro	
		mm Inch	mm Inch	mm Inch	mm Inch	mm Inch	mm Inch	mm Inch			
SD216A-3.0-50-4R1	02712383	3,0 0.118	50,0 1.969	88,0 3.465	61,0 2.402	27,0 1.063	56,0 2.205	4,0 0.157	136°	TiAIN + TiN	IT9
SD216A-3.5-60-4R1	02712384	3,5 0.138	60,0 2.362	99,0 3.898	72,0 2.835	27,0 1.063	67,0 2.638	4,0 0.157	136°	TiAIN + TiN	IT9
SD216A-4.0-60-4R1	02712385	4,0 0.157	60,0 2.362	99,0 3.898	72,0 2.835	27,0 1.063	67,0 2.638	4,0 0.157	136°	TiAIN + TiN	IT9
SD216A-4.5-70-6R1	02712386	4,5 0.177	70,0 2.756	117,0 4.606	81,0 3.189	36,0 1.417	79,0 3.110	6,0 0.236	136°	TiAIN + TiN	IT9
SD216A-5.0-90-6R1	02637529	5,0 0.197	90,0 3.543	142,0 5.591	106,0 4.173	36,0 1.417	103,0 4.055	6,0 0.236	136°	TiAIN + TiN	IT9
SD216A-5.5-90-6R1	02637530	5,5 0.217	90,0 3.543	142,0 5.591	106,0 4.173	36,0 1.417	103,0 4.055	6,0 0.236	136°	TiAIN + TiN	IT9
SD216A-6.0-90-6R1	02637531	6,0 0.236	90,0 3.543	142,0 5.591	106,0 4.173	36,0 1.417	103,0 4.055	6,0 0.236	136°	TiAIN + TiN	IT9
SD216A-6.35-120-8R1	02656536	6,35 0.250	120,0 4.724	177,0 6.969	141,0 5.551	36,0 1.417	137,0 5.394	8,0 0.315	136°	TiAIN + TiN	IT9
SD216A-6.5-120-8R1	02637532	6,5 0.256	120,0 4.724	177,0 6.969	141,0 5.551	36,0 1.417	137,0 5.394	8,0 0.315	136°	TiAIN + TiN	IT9
SD216A-7.0-120-8R1	02637533	7,0 0.276	120,0 4.724	177,0 6.969	141,0 5.551	36,0 1.417	137,0 5.394	8,0 0.315	136°	TiAIN + TiN	IT9
SD216A-7.5-120-8R1	02637534	7,5 0.295	120,0 4.724	177,0 6.969	141,0 5.551	36,0 1.417	137,0 5.394	8,0 0.315	136°	TiAIN + TiN	IT9
SD216A-8.0-120-8R1	02637536	8,0 0.315	120,0 4.724	177,0 6.969	141,0 5.551	36,0 1.417	137,0 5.394	8,0 0.315	136°	TiAIN + TiN	IT9
SD216A-8.5-150-10R1	02637539	8,5 0.335	150,0 5.906	216,0 8.504	176,0 6.929	40,0 1.575	172,0 6.772	10,0 0.394	136°	TiAIN + TiN	IT9
SD216A-9.0-150-10R1	02637540	9,0 0.354	150,0 5.906	216,0 8.504	176,0 6.929	40,0 1.575	172,0 6.772	10,0 0.394	136°	TiAIN + TiN	IT9
SD216A-9.5-150-10R1	02637541	9,5 0.374	150,0 5.906	216,0 8.504	176,0 6.929	40,0 1.575	172,0 6.772	10,0 0.394	136°	TiAIN + TiN	IT9
SD216A-9.52-150-10R1	02656537	9,52 0.375	150,0 5.906	216,0 8.504	176,0 6.929	40,0 1.575	172,0 6.772	10,0 0.394	136°	TiAIN + TiN	IT9
SD216A-10.0-150-10R1	02637542	10,0 0.394	150,0 5.906	216,0 8.504	176,0 6.929	40,0 1.575	172,0 6.772	10,0 0.394	136°	TiAIN + TiN	IT9
SD216A-10.5-180-12R1	02637543	10,5 0.413	180,0 7.087	256,0 10.079	211,0 8.307	45,0 1.772	207,0 8.150	12,0 0.472	136°	TiAIN + TiN	IT9
SD216A-11.0-180-12R1	02637544	11,0 0.433	180,0 7.087	256,0 10.079	211,0 8.307	45,0 1.772	207,0 8.150	12,0 0.472	136°	TiAIN + TiN	IT9
SD216A-11.5-180-12R1	02637545	11,5 0.453	180,0 7.087	256,0 10.079	211,0 8.307	45,0 1.772	207,0 8.150	12,0 0.472	136°	TiAIN + TiN	IT9
SD216A-12.0-180-12R1	02637546	12,0 0.472	180,0 7.087	256,0 10.079	211,0 8.307	45,0 1.772	207,0 8.150	12,0 0.472	136°	TiAIN + TiN	IT9

Introduzione

Foratura

Alesatura

Barenatura

Allegato

SD230A

Profondità di foratura ~ 30 x D – Misure metriche/Pollici

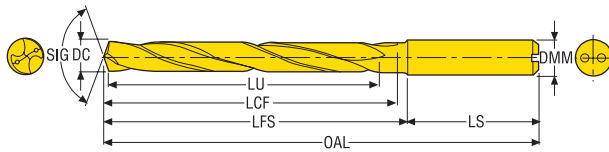

- Codolo cilindrico DIN 6537A
- Adduzione refrigerante interna
- Per i parametri di taglio raccomandati, vedere pagina(e) 153
- Per i diametri intermedi, utilizzare MyDesign.

Codice di ordinazione	Codice prodotto	DC	LU	OAL	LFS	LS	LCF	DMM	Angolo di punta	Rivestimento	Tolleranza foro
		mm Inch	mm Inch	mm Inch	mm Inch	mm Inch	mm Inch	mm Inch			
SD230A-4.0-112-4R1	02712361	4,0 0.157	112,0 4.409	151,0 5.945	124,0 4.882	27,0 1.063	119,0 4.685	4,0 0.157	136°	TiAIN + TiN	IT9
SD230A-4.5-135-6R1	02712362	4,5 0.177	135,0 5.315	185,0 7.283	149,0 5.866	36,0 1.417	145,0 5.709	6,0 0.236	136°	TiAIN + TiN	IT9
SD230A-5.0-170-6R1	02712363	5,0 0.197	170,0 6.693	220,0 8.661	184,0 7.244	36,0 1.417	180,0 7.087	6,0 0.236	136°	TiAIN + TiN	IT9
SD230A-5.5-170-6R1	02712364	5,5 0.217	170,0 6.693	220,0 8.661	184,0 7.244	36,0 1.417	180,0 7.087	6,0 0.236	136°	TiAIN + TiN	IT9
SD230A-6.0-170-6R1	02712365	6,0 0.236	170,0 6.693	220,0 8.661	184,0 7.244	36,0 1.417	180,0 7.087	6,0 0.236	136°	TiAIN + TiN	IT9
SD230A-02500-886-0315R1	02712366	6,35 0.250	225,0 8.858	279,0 10.984	243,0 9.567	36,0 1.417	239,0 9.409	8,0 0.315	136°	TiAIN + TiN	IT9
SD230A-6.5-225-8R1	02712367	6,5 0.256	225,0 8.858	279,0 10.984	243,0 9.567	36,0 1.417	239,0 9.409	8,0 0.315	136°	TiAIN + TiN	IT9
SD230A-7.0-225-8R1	02712370	7,0 0.276	225,0 8.858	279,0 10.984	243,0 9.567	36,0 1.417	239,0 9.409	8,0 0.315	136°	TiAIN + TiN	IT9
SD230A-7.5-225-8R1	02712371	7,5 0.295	225,0 8.858	279,0 10.984	243,0 9.567	36,0 1.417	239,0 9.409	8,0 0.315	136°	TiAIN + TiN	IT9
SD230A-03125-886-0315R1	02712374	7,938 0.313	225,0 8.858	279,0 10.984	243,0 9.567	36,0 1.417	239,0 9.409	8,0 0.315	136°	TiAIN + TiN	IT9
SD230A-8.0-225-8R1	02712376	8,0 0.315	225,0 8.858	279,0 10.984	243,0 9.567	36,0 1.417	239,0 9.409	8,0 0.315	136°	TiAIN + TiN	IT9
SD230A-8.5-285-10R1	02712378	8,5 0.335	285,0 11.220	346,0 13.622	306,0 12.047	40,0 1.575	302,0 11.890	10,0 0.394	136°	TiAIN + TiN	IT9
SD230A-9.0-285-10R1	02712379	9,0 0.354	285,0 11.220	346,0 13.622	306,0 12.047	40,0 1.575	302,0 11.890	10,0 0.394	136°	TiAIN + TiN	IT9
SD230A-9.5-285-10R1	02712380	9,5 0.374	285,0 11.220	346,0 13.622	306,0 12.047	40,0 1.575	302,0 11.890	10,0 0.394	136°	TiAIN + TiN	IT9
SD230A-03750-1122-0394R1	02712381	9,525 0.375	285,0 11.220	346,0 13.622	306,0 12.047	40,0 1.575	302,0 11.890	10,0 0.394	136°	TiAIN + TiN	IT9
SD230A-10.0-285-10R1	02712382	10,0 0.394	285,0 11.220	346,0 13.622	306,0 12.047	40,0 1.575	302,0 11.890	10,0 0.394	136°	TiAIN + TiN	IT9

SD2040A

Profondità di foratura ~ 40 x D – Misure metriche/Pollici

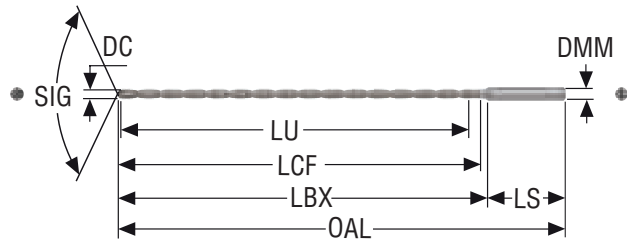

- Codolo cilindrico DIN 6537A
- Adduzione refrigerante interna
- Per i parametri di taglio raccomandati, vedere pagina(e) 154
- Per i diametri intermedi, utilizzare MyDesign.

Codice di ordinazione	Codice prodotto	DC	DMM	LU	LCF	LB	OAL	LS	Angolo di punta Rivestimento	Tolleranza foro
		mm Inch	mm Inch	mm Inch	mm Inch	mm Inch	mm Inch	mm Inch		
SD2040A-0300-120-04R1	10143441	3,0 0.118	4,0 0.157	120 4.724	128,0 5.039	130,0 5.118	157,0 6.181	27,0 1.063	133°	TiAIN + TiN IT9-10
SD2040A-0400-160-04R1	10143442	4,0 0.157	4,0 0.157	160 6.299	169,0 6.654	142,0 5.591	198,0 7.795	27,0 1.063	133°	TiAIN + TiN IT9-10
SD2040A-0450-180-06R1	10143443	4,5 0.177	6,0 0.236	180 7.087	190,0 7.480	202,0 7.953	238,0 9.370	36,0 1.417	133°	TiAIN + TiN IT9-10
SD2040A-0500-200-06R1	10143444	5,0 0.197	6,0 0.236	200 7.874	210,5 8.287	213,0 8.386	249,0 9.803	36,0 1.417	133°	TiAIN + TiN IT9-10
SD2040A-0600-240-06R1	10143445	6,0 0.236	6,0 0.236	240 9.449	252,0 9.921	254,0 10.000	290,0 11.417	36,0 1.417	133°	TiAIN + TiN IT9-10
SD2040A-0635-254-08R1	10143446	6,35 0.250	8,0 0.315	254 10.000	266,5 10.492	275,0 10.827	311,0 12.244	36,0 1.417	133°	TiAIN + TiN IT9-10
SD2040A-0650-260-08R1	10143447	6,5 0.256	8,0 0.315	260 10.236	273,0 10.748	275,0 10.827	311,0 12.244	36,0 1.417	133°	TiAIN + TiN IT9-10
SD2040A-0700-280-08R1	10143448	7,0 0.276	8,0 0.315	280 11.024	293,5 11.555	296,0 11.654	332,0 13.071	36,0 1.417	133°	TiAIN + TiN IT9-10
SD2040A-0750-300-08R1	10143449	7,5 0.295	8,0 0.315	300 11.811	314,0 12.362	316,0 12.441	352,0 13.858	36,0 1.417	133°	TiAIN + TiN IT9-10
SD2040A-0800-320-08R1	10143450	8,0 0.315	8,0 0.315	320 12.598	335,0 13.189	337,0 13.268	373,0 14.685	36,0 1.417	133°	TiAIN + TiN IT9-10

Introduzione

Foratura

Alésatura

Barenatura

Allegato

SD2050A

Profondità di foratura ~ 50 x D – Misure metriche/Pollici

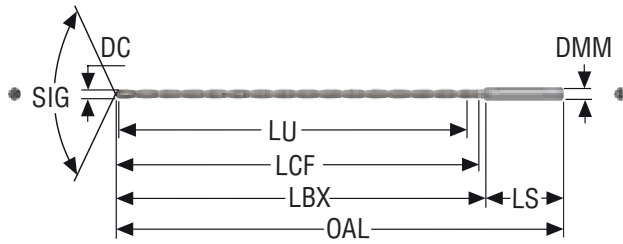

- Codolo cilindrico DIN 6537A
- Adduzione refrigerante interna
- Per i parametri di taglio raccomandati, vedere pagina(e) 154
- Per i diametri intermedi, utilizzare MyDesign.

Codice di ordinazione	Codice prodotto	DC	DMM	LU	LCF	LB	OAL	LS	Angolo di punta	Rivestimento	Tolleranza foro
		mm Inch	mm Inch	mm Inch	mm Inch	mm Inch	mm Inch	mm Inch			
SD2050A-0300-150-04R1	10188284	3,0 0.118	4,0 0.157	150 5.906	157,5 6.201	161,0 6.339	188,0 7.402	27,0 1.063	133°	TiAIN + TiN	IT9
SD2050A-0400-200-04R1	10188285	4,0 0.157	4,0 0.157	200 7.874	209,0 8.228	213,0 8.386	240,0 9.449	27,0 1.063	133°	TiAIN + TiN	IT9
SD2050A-0450-225-06R1	10188286	4,5 0.177	6,0 0.236	225 8.858	234,75 9.242	252,0 9.921	288,0 11.339	36,0 1.417	133°	TiAIN + TiN	IT9
SD2050A-0500-250-06R1	10188287	5,0 0.197	6,0 0.236	250 9.843	260,5 10.256	264,0 10.394	300,0 11.811	36,0 1.417	133°	TiAIN + TiN	IT9
SD2050A-0600-300-06R1	10188288	6,0 0.236	6,0 0.236	300 11.811	312,0 12.283	316,0 12.441	352,0 13.858	36,0 1.417	133°	TiAIN + TiN	IT9
SD2050A-0635-318-08R1	10188289	6,35 0.250	8,0 0.315	318 12.520	330,5 13.012	337,0 13.268	373,0 14.685	36,0 1.417	133°	TiAIN + TiN	IT9

Introduzione

Foratura

Alesatura

Barenatura

Allegato

SD2060A

Profondità di foratura ~ 60 x D – Misure metriche/Pollici

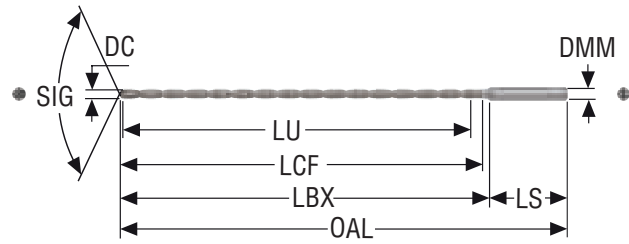

- Codolo cilindrico DIN 6537A
- Adduzione refrigerante interna
- Per i parametri di taglio raccomandati, vedere pagina(e) 154
- Per i diametri intermedi, utilizzare MyDesign.

Codice di ordinazione	Codice prodotto	DC	DMM	LU	LCF	LB	OAL	LS	Angolo di punta Rivestimento	Tolleranza foro
		mm Inch	mm Inch	mm Inch	mm Inch	mm Inch	mm Inch	mm Inch		
SD2060A-0300-180-04R1	10188290	3,0 0.118	4,0 0.157	180 7.087	187,5 7.382	191,0 7.520	218,0 8.583	27,0 1.063	133°	TiAIN + TiN IT9
SD2060A-0400-240-04R1	10188291	4,0 0.157	4,0 0.157	240 9.449	249,0 9.803	253,0 9.961	280,0 11.024	27,0 1.063	133°	TiAIN + TiN IT9
SD2060A-0450-270-06R1	10188292	4,5 0.177	6,0 0.236	270 10.630	280,0 11.024	283,0 11.142	319,0 12.559	36,0 1.417	133°	TiAIN + TiN IT9
SD2060A-0500-300-06R1	10188293	5,0 0.197	6,0 0.236	300 11.811	310,5 12.224	314,0 12.362	350,0 13.780	36,0 1.417	133°	TiAIN + TiN IT9

Introduzione

Foratura

Allesatura

Barenatura

Allegato



Feedmax™ SD245A

Le punte in metallo duro integrale Seco Feedmax SD245A offrono maggiore stabilità e migliori prestazioni in applicazioni con uscite foro irregolari e tagli interrotti dovuti a fori trasversali. Le seguenti caratteristiche consentono di ottenere geometrie dei fori ottimali:

- Quattro pattini di guida
- Estremità ottimizzata auto-centrante
- Rivestimento TiAlN+TiN ad elevata resistenza all'usura
- Preparazione del tagliente migliorata

SD245A

Profondità di foratura ~ 5 x D – Misure metriche/Pollici

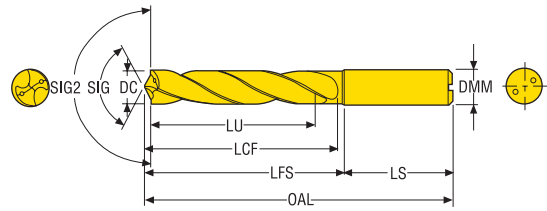

- Codolo cilindrico DIN 6537A
- Adduzione refrigerante interna
- Per i parametri di taglio raccomandati, vedere pagina(e) 155
- Per i diametri intermedi, utilizzare MyDesign.

Codice di ordinazione	Codice prodotto	DC	LU	OAL	LFS	LS	LCF	DMM	Angolo di punta	Rivestimento	Tolleranza foro
		mm Inch	mm Inch	mm Inch	mm Inch	mm Inch	mm Inch	mm Inch			
SD245A-5.0-32-6R1	02691683	5,0 0.197	32,0 1.260	82,0 3.228	46,0 1.811	36,0 1.417	44,0 1.732	6,0 0.236	140°/180°	TiAIN + TiN	IT8
SD245A-6.0-32-6R1	02691684	6,0 0.236	32,0 1.260	82,0 3.228	46,0 1.811	36,0 1.417	44,0 1.732	6,0 0.236	140°/180°	TiAIN + TiN	IT8
SD245A-02500-138-0315R1	02691686	6,35 0.2500	35,0 1.378	91,0 3.583	55,0 2.165	36,0 1.417	53,0 2.087	8,0 0.315	140°/180°	TiAIN + TiN	IT8
SD245A-6.5-35-8R1	02691687	6,5 0.256	35,0 1.378	91,0 3.583	55,0 2.165	36,0 1.417	53,0 2.087	8,0 0.315	140°/180°	TiAIN + TiN	IT8
SD245A-02656-157-0315R1	02691688	6,747 0.2656	40,0 1.575	91,0 3.583	55,0 2.165	36,0 1.417	53,0 2.087	8,0 0.315	140°/180°	TiAIN + TiN	IT8
SD245A-6.8-40-8R1	02691689	6,8 0.268	40,0 1.575	91,0 3.583	55,0 2.165	36,0 1.417	53,0 2.087	8,0 0.315	140°/180°	TiAIN + TiN	IT8
SD245A-7.0-40-8R1	02691690	7,0 0.276	40,0 1.575	91,0 3.583	55,0 2.165	36,0 1.417	53,0 2.087	8,0 0.315	140°/180°	TiAIN + TiN	IT8
SD245A-02813-157-0315R1	02691691	7,144 0.2813	40,0 1.575	91,0 3.583	55,0 2.165	36,0 1.417	53,0 2.087	8,0 0.315	140°/180°	TiAIN + TiN	IT8
SD245A-7.5-40-8R1	02691692	7,5 0.295	40,0 1.575	91,0 3.583	55,0 2.165	36,0 1.417	53,0 2.087	8,0 0.315	140°/180°	TiAIN + TiN	IT8
SD245A-03125-165-0315R1	02691693	7,938 0.3125	42,0 1.654	91,0 3.583	55,0 2.165	36,0 1.417	53,0 2.087	8,0 0.315	140°/180°	TiAIN + TiN	IT8
SD245A-8.0-42-8R1	02691694	8,0 0.315	42,0 1.654	91,0 3.583	55,0 2.165	36,0 1.417	53,0 2.087	8,0 0.315	140°/180°	TiAIN + TiN	IT8
SD245A-8.5-42-10R1	02691695	8,5 0.335	42,0 1.654	103,0 4.055	63,0 2.480	40,0 1.575	61,0 2.402	10,0 0.394	140°/180°	TiAIN + TiN	IT8
SD245A-9.0-45-10R1	02546059	9,0 0.354	45,0 1.772	103,0 4.055	63,0 2.480	40,0 1.575	61,0 2.402	10,0 0.394	140°/180°	TiAIN + TiN	IT8
SD245A-9.5-45-10R1	02691696	9,5 0.374	45,0 1.772	103,0 4.055	63,0 2.480	40,0 1.575	61,0 2.402	10,0 0.394	140°/180°	TiAIN + TiN	IT8
SD245A-03750-189-0394R1	02691697	9,525 0.3750	48,0 1.890	103,0 4.055	63,0 2.480	40,0 1.575	61,0 2.402	10,0 0.394	140°/180°	TiAIN + TiN	IT8
SD245A-10.0-48-10R1	02536888	10,0 0.394	48,0 1.890	103,0 4.055	63,0 2.480	40,0 1.575	61,0 2.402	10,0 0.394	140°/180°	TiAIN + TiN	IT8
SD245A-10.2-48-12R1	02691699	10,2 0.402	48,0 1.890	118,0 4.646	73,0 2.874	45,0 1.772	71,0 2.795	12,0 0.472	140°/180°	TiAIN + TiN	IT8
SD245A-04063-189-0472R1	02691700	10,319 0.4063	48,0 1.890	118,0 4.646	73,0 2.874	45,0 1.772	71,0 2.795	12,0 0.472	140°/180°	TiAIN + TiN	IT8
SD245A-10.5-48-12R1	02691701	10,5 0.413	48,0 1.890	118,0 4.646	73,0 2.874	45,0 1.772	71,0 2.795	12,0 0.472	140°/180°	TiAIN + TiN	IT8
SD245A-11.0-56-12R1	02561860	11,0 0.433	56,0 2.205	118,0 4.646	73,0 2.874	45,0 1.772	71,0 2.795	12,0 0.472	140°/180°	TiAIN + TiN	IT8
SD245A-04375-221-0472R1	02691702	11,113 0.4375	56,0 2.205	118,0 4.646	73,0 2.874	45,0 1.772	71,0 2.795	12,0 0.472	140°/180°	TiAIN + TiN	IT8
SD245A-11.5-56-12R1	02691704	11,5 0.453	56,0 2.205	118,0 4.646	73,0 2.874	45,0 1.772	71,0 2.795	12,0 0.472	140°/180°	TiAIN + TiN	IT8

Introduzione

Foratura

Alesatura

Barenatura

Allegato

Codice di ordinazione	Codice prodotto	DC	LU	OAL	LFS	LS	LCF	DMM	Angolo di punta	Rivestimento	Tolleranza foro
		mm <i>Inch</i>	mm <i>Inch</i>	mm <i>Inch</i>	mm <i>Inch</i>	mm <i>Inch</i>	mm <i>Inch</i>	mm <i>Inch</i>			
SD245A-12.0-56-12R1	02691705	12,0 <i>0.472</i>	56,0 <i>2.205</i>	118,0 <i>4.646</i>	73,0 <i>2.874</i>	45,0 <i>1.772</i>	71,0 <i>2.795</i>	12,0 <i>0.472</i>	140°/180°	TiAIN + TiN	IT8
SD245A-12.5-56-14R1	02691706	12,5 <i>0.492</i>	56,0 <i>2.205</i>	124,0 <i>4.882</i>	79,0 <i>3.110</i>	45,0 <i>1.772</i>	77,0 <i>3.031</i>	14,0 <i>0.551</i>	140°/180°	TiAIN + TiN	IT8
SD245A-0500-221-0551R1	02691707	12,7 <i>0.500</i>	56,0 <i>2.205</i>	124,0 <i>4.882</i>	79,0 <i>3.110</i>	45,0 <i>1.772</i>	77,0 <i>3.031</i>	14,0 <i>0.551</i>	140°/180°	TiAIN + TiN	IT8
SD245A-13.0-56-14R1	02691708	13,0 <i>0.512</i>	56,0 <i>2.205</i>	124,0 <i>4.882</i>	79,0 <i>3.110</i>	45,0 <i>1.772</i>	77,0 <i>3.031</i>	14,0 <i>0.551</i>	140°/180°	TiAIN + TiN	IT8
SD245A-05312-232-0551R1	02691709	13,494 <i>0.5312</i>	59,0 <i>2.323</i>	124,0 <i>4.882</i>	79,0 <i>3.110</i>	45,0 <i>1.772</i>	77,0 <i>3.031</i>	14,0 <i>0.551</i>	140°/180°	TiAIN + TiN	IT8
SD245A-13.5-59-14R1	02691710	13,5 <i>0.5312</i>	59,0 <i>2.323</i>	124,0 <i>4.882</i>	79,0 <i>3.110</i>	45,0 <i>1.772</i>	77,0 <i>3.031</i>	14,0 <i>0.551</i>	140°/180°	TiAIN + TiN	IT8
SD245A-14.0-59-14R1	02691711	14,0 <i>0.551</i>	59,0 <i>2.323</i>	124,0 <i>4.882</i>	79,0 <i>3.110</i>	45,0 <i>1.772</i>	77,0 <i>3.031</i>	14,0 <i>0.551</i>	140°/180°	TiAIN + TiN	IT8

Introduzione

Foratura

Alesatura

Barenatura

Allegato



Feedmax™ SD265A

Le punte Seco Feedmax SD265A ad alta precisione IT 7 offrono un'accuratezza impeccabile. Inoltre, una punta SD265A è in grado di sostituire utensili multipli e semplificare le attività di foratura più complesse. Le seguenti caratteristiche consentono all'utente di effettuare fori di precisione in un'unica passata:

- Geometria di foratura ottimizzata e facilità di centraggio automatico
- 6 pattini di guida
- Strette tolleranze costruttive ($\pm 3 \mu$)
- Rivestimento in TiAlN per un basso attrito e un'elevata resistenza all'usura

SD265A

Profondità di foratura ~ 5 x D – Misure metriche/Pollici

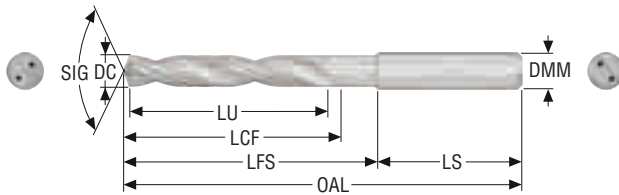

- Codolo cilindrico DIN 6537A
- Adduzione refrigerante interna
- Per i parametri di taglio raccomandati, vedere pagina(e) 156
- Per i diametri intermedi, utilizzare MyDesign.

Codice di ordinazione	Codice prodotto	DC	LU	OAL	LFS	LS	LCF	DMM	Angolo di punta	Rivestimento	Tolleranza foro
		mm Inch	mm Inch	mm Inch	mm Inch	mm Inch	mm Inch	mm Inch			
SD265A-6.006-32-6R1	02691714	6,006 0.236	32,0 1.260	82,0 3.228	46,0 1.811	36,0 1.417	44,0 1.732	6,0 0.236	140°	TiAIN + TiN	IT7
SD265A-02497-138-0315R1	02722876	6,35 0.250	35,0 1.378	91,0 3.583	55,0 2.165	36,0 1.417	53,0 2.087	8,0 0.315	140°	TiAIN + TiN	IT7
SD265A-03122-165-0315R1	02722877	7,938 0.313	42,0 1.654	91,0 3.583	55,0 2.165	36,0 1.417	53,0 2.087	8,0 0.315	140°	TiAIN + TiN	IT7
SD265A-8.008-42-8R1	02691715	8,008 0.315	42,0 1.654	91,0 3.583	55,0 2.165	36,0 1.417	53,0 2.087	8,0 0.315	140°	TiAIN + TiN	IT7
SD265A-03747-189-0394R1	02722878	9,525 0.375	48,0 1.890	103,0 4.055	63,0 2.480	40,0 1.575	61,0 2.402	10,0 0.394	140°	TiAIN + TiN	IT7
SD265A-10.008-48-10R1	02691716	10,008 0.394	48,0 1.890	103,0 4.055	63,0 2.480	40,0 1.575	61,0 2.402	10,0 0.394	140°	TiAIN + TiN	IT7
SD265A-12.009-56-12R1	02691717	12,009 0.473	56,0 2.205	118,0 4.646	73,0 2.874	45,0 1.772	71,0 2.795	12,0 0.472	140°	TiAIN + TiN	IT7
SD265A-04997-221-0551R1	02722879	12,7 0.500	56,0 2.205	124,0 4.882	79,0 3.110	45,0 1.772	77,0 3.031	14,0 0.551	140°	TiAIN + TiN	IT7
SD265A-14.009-59-14R1	02691718	14,009 0.552	59,0 2.323	124,0 4.882	79,0 3.110	45,0 1.772	77,0 3.031	14,0 0.551	140°	TiAIN + TiN	IT7
SD265A-16.009-62-16R1	02691719	16,009 0.630	62,0 2.441	133,0 5.236	85,0 3.346	48,0 1.890	83,0 3.268	16,0 0.630	140°	TiAIN + TiN	IT7



Feedmax™ – Punta per smussi

Le punte per smussi Feedmax™ Seco combinano foratura e smussatura in un unico processo per massimizzare l'efficienza. La gamma standard a magazzino copre applicazioni di pre-foratura per le filettature metriche standard comuni da M4 a M16.

- Il design speciale riduce al minimo il costo per foro e aumenta la produttività
- Lo speciale rivestimento a basso attrito garantisce un'elevata durezza a caldo e un'eccellente rimozione del truciolo
- La geometria auto-centrante consente di praticare fori di alta qualità con un angolo di smusso di 45°

Punte per smussi – Filettatura M4 - M16

Misure metriche/Pollici

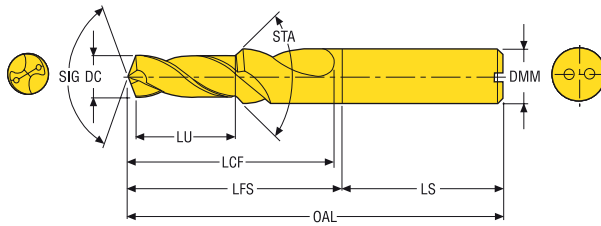

- Codolo cilindrico DIN 6537A
- Adduzione refrigerante interna
- Rivestimento: TiAlN + TiN
- Tolleranza foro: IT8-9
- Angolo di smusso incluso = 90°
- Per i parametri di taglio raccomandati, vedere pagina(e) 145, 146

Codice di ordinazione	Codice prodotto	Tipo di filettatura	Dimensione filettatura	DC	LU	OAL	LFS	LS	LCF	DMM
				mm Inch	mm Inch	mm Inch	mm Inch	mm Inch	mm Inch	
SD203A-C45-3.3-11.4-6R1	02500320	Passo normale Filettatura metrica	M4	3,3 0.130	11,4 0.449	66,0 2.598	26,0 1.024	36,0 1.417	20,0 0.787	6,0 0.236
SD203A-C45-3.4-11.4-6R1	02500323	Passo normale Filettatura metrica	M4	3,4 0.134	11,4 0.449	66,0 2.598	26,0 1.024	36,0 1.417	20,0 0.787	6,0 0.236
SD203A-C45-4.2-13.6-6R1	02500324	Passo normale Filettatura metrica	M5	4,2 0.165	13,6 0.535	66,0 2.598	30,0 1.181	36,0 1.417	24,0 0.945	6,0 0.236
SD203A-C45-4.3-13.6-6R1	02500325	Passo normale Filettatura metrica	M5	4,3 0.169	13,6 0.535	66,0 2.598	30,0 1.181	36,0 1.417	24,0 0.945	6,0 0.236
SD203A-C45-5.0-16.5-8R1	02500326	Passo normale Filettatura metrica	M6	5,0 0.197	16,5 0.650	79,0 3.110	43,0 1.693	36,0 1.417	28,0 1.102	8,0 0.315
SD203A-C45-5.1-16.5-8R1	02500327	Passo normale Filettatura metrica	M6	5,1 0.201	16,5 0.650	79,0 3.110	43,0 1.693	36,0 1.417	28,0 1.102	8,0 0.315
SD203A-C45-6.8-21-10R1	02500328	Passo normale Filettatura metrica	M8	6,8 0.268	21,0 0.827	89,0 3.504	49,0 1.929	40,0 1.575	34,0 1.339	10,0 0.394
SD203A-C45-6.9-21-10R1	02500330	Passo normale Filettatura metrica	M8	6,9 0.272	21,0 0.827	89,0 3.504	49,0 1.929	40,0 1.575	34,0 1.339	10,0 0.394
SD203A-C45-7.0-21-10R1	02500331	Passo fine Filettatura metrica	M8x1.0	7,0 0.276	21,0 0.827	89,0 3.504	49,0 1.929	40,0 1.575	34,0 1.339	10,0 0.394
SD203A-C45-8.5-25.5-12R1	02500333	Passo normale Filettatura metrica	M10	8,5 0.335	25,5 1.004	102,0 4.016	57,0 2.244	45,0 1.772	47,0 1.850	12,0 0.472
SD203A-C45-8.7-25.5-12R1	02500334	Passo normale Filettatura metrica	M10	8,7 0.343	25,5 1.004	102,0 4.016	57,0 2.244	45,0 1.772	47,0 1.850	12,0 0.472
SD203A-C45-9.0-25.5-12R1	02500340	Passo fine Filettatura metrica	M10x1.0	9,0 0.354	25,5 1.004	102,0 4.016	57,0 2.244	45,0 1.772	47,0 1.850	12,0 0.472
SD203A-C45-10.2-30.0-14R1	02500342	Passo normale Filettatura metrica	M12	10,2 0.402	30,0 1.181	107,0 4.213	62,0 2.441	45,0 1.772	55,0 2.165	14,0 0.551
SD203A-C45-10.4-30.0-14R1	02500343	Passo normale Filettatura metrica	M12	10,4 0.409	30,0 1.181	107,0 4.213	62,0 2.441	45,0 1.772	55,0 2.165	14,0 0.551
SD203A-C45-10.5-30.0-14R1	02500344	Passo fine Filettatura metrica	M12x1.5	10,5 0.413	34,5 1.358	107,0 4.213	62,0 2.441	45,0 1.772	55,0 2.165	14,0 0.551
SD203A-C45-12.0-34.5-16R1	02500346	Passo normale Filettatura metrica	M14	12,0 0.472	34,5 1.358	115,0 4.528	70,0 2.756	45,0 1.772	60,0 2.362	16,0 0.630
SD203A-C45-12.25-34.5-16R1	02500348	Passo normale Filettatura metrica	M14	12,25 0.482	34,5 1.358	115,0 4.528	70,0 2.756	45,0 1.772	60,0 2.362	16,0 0.630
SD203A-C45-12.5-34.5-16R1	02500349	Passo fine Filettatura metrica	M14x1.5	12,5 0.492	34,5 1.358	115,0 4.528	70,0 2.756	45,0 1.772	60,0 2.362	16,0 0.630
SD203A-C45-14.0-38.5-18R1	02500350	Passo normale Filettatura metrica	M16	14,0 0.551	38,5 1.516	123,0 4.843	75,0 2.953	48,0 1.890	65,0 2.559	18,0 0.709
SD203A-C45-14.25-38.5-18R1	02500354	Passo normale Filettatura metrica	M16	14,25 0.561	38,5 1.516	123,0 4.843	75,0 2.953	48,0 1.890	65,0 2.559	18,0 0.709
SD203A-C45-14.5-38.5-18R1	02500356	Passo fine Filettatura metrica	M16x1.5	14,5 0.571	38,5 1.516	123,0 4.843	75,0 2.953	48,0 1.890	65,0 2.559	18,0 0.709

Punte per smussi – Filettatura M4 - M16

Misure metriche/Pollici

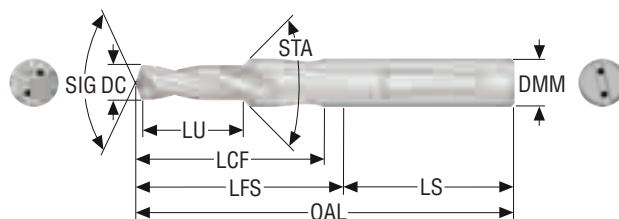

- Codolo Whistle Notch DIN6537B
- Addizione refrigerante interna
- Rivestimento: TiAlN + TiN
- Tolleranza foro: IT8-9
- Angolo di smusso incluso = 90°
- Per i parametri di taglio raccomandati, vedere pagina(e) 145, 146

Codice di ordinazione	Codice prodotto	Tipo di filettatura	Dimensione filettatura	DC	LU	OAL	LFS	LS	LCF	DMM
				mm Inch	mm Inch	mm Inch	mm Inch	mm Inch	mm Inch	mm Inch
SD203A-C45-3.3-11.4-6R5	02500382	Passo normale Filettatura metrica	M4	3,3 0.130	11,4 0.449	66,0 2.598	26,0 1.024	36,0 1.417	20,0 0.787	6,0 0.236
SD203A-C45-3.4-11.4-6R5	02500383	Passo normale Filettatura metrica	M4	3,4 0.134	11,4 0.449	66,0 2.598	26,0 1.024	36,0 1.417	20,0 0.787	6,0 0.236
SD203A-C45-4.2-13.6-6R5	02500391	Passo normale Filettatura metrica	M5	4,2 0.165	13,6 0.535	66,0 2.598	30,0 1.181	36,0 1.417	24,0 0.945	6,0 0.236
SD203A-C45-4.3-13.6-6R5	02500392	Passo normale Filettatura metrica	M5	4,3 0.169	13,6 0.535	66,0 2.598	30,0 1.181	36,0 1.417	24,0 0.945	6,0 0.236
SD203A-C45-5.0-16.5-8R5	02500393	Passo normale Filettatura metrica	M6	5,0 0.197	16,5 0.650	79,0 3.110	43,0 1.693	36,0 1.417	28,0 1.102	8,0 0.315
SD203A-C45-5.1-16.5-8R5	02500394	Passo normale Filettatura metrica	M6	5,1 0.201	16,5 0.650	79,0 3.110	43,0 1.693	36,0 1.417	28,0 1.102	8,0 0.315
SD203A-C45-6.8-21.0-10R5	02500395	Passo normale Filettatura metrica	M8	6,8 0.268	21,0 0.827	89,0 3.504	49,0 1.929	40,0 1.575	34,0 1.339	10,0 0.394
SD203A-C45-6.9-21.0-10R5	02500396	Passo normale Filettatura metrica	M8	6,9 0.272	21,0 0.827	89,0 3.504	49,0 1.929	40,0 1.575	34,0 1.339	10,0 0.394
SD203A-C45-7.0-21.0-10R5	02500398	Passo fine Filettatura metrica	M8x1.0	7,0 0.276	21,0 0.827	89,0 3.504	49,0 1.929	40,0 1.575	34,0 1.339	10,0 0.394
SD203A-C45-8.5-25.5-12R5	02500401	Passo normale Filettatura metrica	M10	8,5 0.335	25,5 1.004	102,0 4.016	57,0 2.244	45,0 1.772	47,0 1.850	12,0 0.472
SD203A-C45-8.7-25.5-12R5	02500403	Passo normale Filettatura metrica	M10	8,7 0.343	25,5 1.004	102,0 4.016	57,0 2.244	45,0 1.772	47,0 1.850	12,0 0.472
SD203A-C45-9.0-25.5-12R5	02500410	Passo fine Filettatura metrica	M10x1.0	9,0 0.354	25,5 1.004	102,0 4.016	57,0 2.244	45,0 1.772	47,0 1.850	12,0 0.472
SD203A-C45-10.2-30.0-14R5	02500412	Passo normale Filettatura metrica	M12	10,2 0.402	30,0 1.181	107,0 4.213	62,0 2.441	45,0 1.772	55,0 2.165	14,0 0.551
SD203A-C45-10.4-30.0-14R5	02500414	Passo normale Filettatura metrica	M12	10,4 0.409	30,0 1.181	107,0 4.213	62,0 2.441	45,0 1.772	55,0 2.165	14,0 0.551
SD203A-C45-10.5-30.0-14R5	02500416	Passo fine Filettatura metrica	M12x1.5	10,5 0.413	34,5 1.358	107,0 4.213	62,0 2.441	45,0 1.772	55,0 2.165	14,0 0.551
SD203A-C45-12.0-34.5-16R5	02500417	Passo normale Filettatura metrica	M14	12,0 0.472	34,5 1.358	115,0 4.528	70,0 2.756	45,0 1.772	60,0 2.362	16,0 0.630
SD203A-C45-12.25-34.5-16R5	02500418	Passo normale Filettatura metrica	M14	12,25 0.482	34,5 1.358	115,0 4.528	70,0 2.756	45,0 1.772	60,0 2.362	16,0 0.630
SD203A-C45-12.5-34.5-16R5	02500420	Passo fine Filettatura metrica	M14x1.5	12,5 0.492	34,5 1.358	115,0 4.528	70,0 2.756	45,0 1.772	60,0 2.362	16,0 0.630
SD203A-C45-14.0-38.5-18R5	02500423	Passo normale Filettatura metrica	M16	14,0 0.551	38,5 1.516	123,0 4.843	75,0 2.953	48,0 1.890	65,0 2.559	18,0 0.709
SD203A-C45-14.25-38.5-18R5	02500424	Passo normale Filettatura metrica	M16	14,25 0.561	38,5 1.516	123,0 4.843	75,0 2.953	48,0 1.890	65,0 2.559	18,0 0.709
SD203A-C45-14.5-38.5-18R5	02500425	Passo fine Filettatura metrica	M16x1.5	14,5 0.571	38,5 1.516	123,0 4.843	75,0 2.953	48,0 1.890	65,0 2.559	18,0 0.709

Introduzione

Foratura

Alesatura

Barenatura

Allegato

Modulo per smussi per punte Universal e Feedmax

In mm

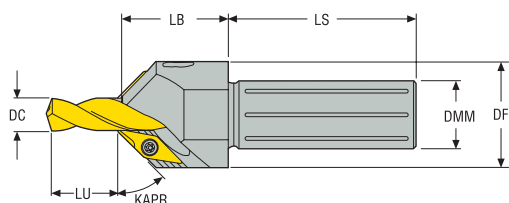

Codice di ordinazione	Codice prodotto	DC	LU profondità di foratura			Max profondità smusso (mm)	LB	DF	LS	DMM	KAPR°
			3 x D (min-max)	5 x D (min-max)	7 x D (min-max)						
		mm	mm	mm	mm	mm	mm	mm	mm	mm	
SD200-C45-6R1	02510275	4,01-6,1	4,0-17,0	10,0-27,0	30,0-45,0	2,8	25,0	21,0	41,0	12,0	45,0
SD200-C45-8R1	02510278	6,01-8,0	15,0-27,0	24,0-35,0	42,0-57,0	2,8	25,0	25,0	44,5	16,0	45,0
SD200-C45-10R1	02510280	8,01-10,0	17,0-31,0	34,0-48,0	47,0-62,0	2,8	25,0	25,0	44,5	16,0	45,0
SD200-C45-12R1	02510281	10,01-12,0	21,0-36,0	40,0-56,0	57,0-72,0	2,8	25,0	28,0	46,5	20,0	45,0
SD200-C45-14R1	02510283	12,01-14,0	22,0-37,0	43,0-59,0	68,0-83,0	2,8	25,0	30,0	46,5	20,0	45,0
SD200-C45-16R1	02510285	14,01-16,0	23,0-39,0	44,0-60,0	76,0-92,0	2,8	34,0	32,0	53,0	25,0	45,0

Parti di ricambio, comprese nella fornitura

Per punta diametro (mm)	Chiave per vite inserto	Vite di bloccaggio inserto	Chiave di bloccaggio	Vite di bloccaggio	Modulo
	Inserto	Inserto	Modulo	Modulo	Modulo
4,00 - 16,00	T07P-2	C02205-T07P	H1.5-2D	SH3040	SD200-3x7.3

Inserto

Tolleranze: mm	Dimensione	L	EPSR	RE	IC	D1	AN	S
		mm		mm	mm	mm		mm
	C45	9,000	45°	0,200	5,556	2,900	7°	2,500
	Qualità: T400D							
	Descrizione: SD200-C45							
	Codice prodotto: 02510325							

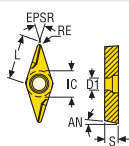

IC = ±0,025
S = ±0,07
RE = ±0,10

Modulo per smussi per punte Universal e Feedmax

Pollici

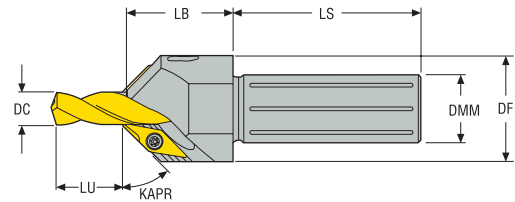

Descrizione	Codice prodotto	DC	LU profondità di foratura			Max profondità smusso (mm)	DF	LB	LS	DMM	KAPR°
			3 x D (min-max)	5 x D (min-max)	7 x D (min-max)						
			Inch	Inch	Inch						
SD200-C45-6-500R1	02510287	0.158-0.240	0.157-0.669	0.394-1.063	1.181-1.772	0.110	0.827	0.984	1.614	0.500	45
SD200-C45-8-625R1	02510289	0.237-0.315	0.591-1.063	0.945-1.378	1.654-2.244	0.110	0.984	0.984	1.752	0.625	45
SD200-C45-10-625R1	02510291	0.315-0.394	0.669-1.220	1.339-1.890	1.850-2.441	0.110	0.984	0.984	1.752	0.625	45
SD200-C45-12-750R1	02510292	0.394-0.472	0.827-1.417	1.575-2.205	2.244-2.835	0.110	1.102	0.984	1.831	0.750	45
SD200-C45-14-750R1	02510293	0.473-0.551	0.866-1.457	1.693-2.323	2.677-3.268	0.110	1.181	0.984	1.831	0.750	45
SD200-C45-16-1000R1	02510295	0.552-0.630	0.906-1.535	1.732-2.362	2.992-3.622	0.110	1.260	1.339	2.087	1.000	45

Parti di ricambio, comprese nella fornitura

Per punta diametro (pollici)	Chiave per vite inserto	Vite di bloccaggio inserto	Chiave di bloccaggio	Modulo
	Inserto	Inserto	Modulo	Modulo
0.1574 - 0.6299	T07P-2	C02205-T07P	H1.5-2D	SD200-3x7.3

Inserto

Tolleranze: inch	Dimensione	L inch	EPSR	RE inch	IC inch	D1 inch	AN	S inch
IC = ±0.001 S = ±0.0027 RE = ±0.004	C45	0.3543	45°	0.0078	0.2187	0.1141	7°	0.0984
	Qualità: T400D							
	Descrizione: SD200-C45							
	Codice prodotto: 02510325							

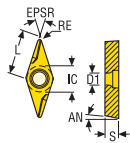

Introduzione

Foratura

Alesatura

Barenatura

Allegato

Istruzioni di montaggio del modulo per smussi

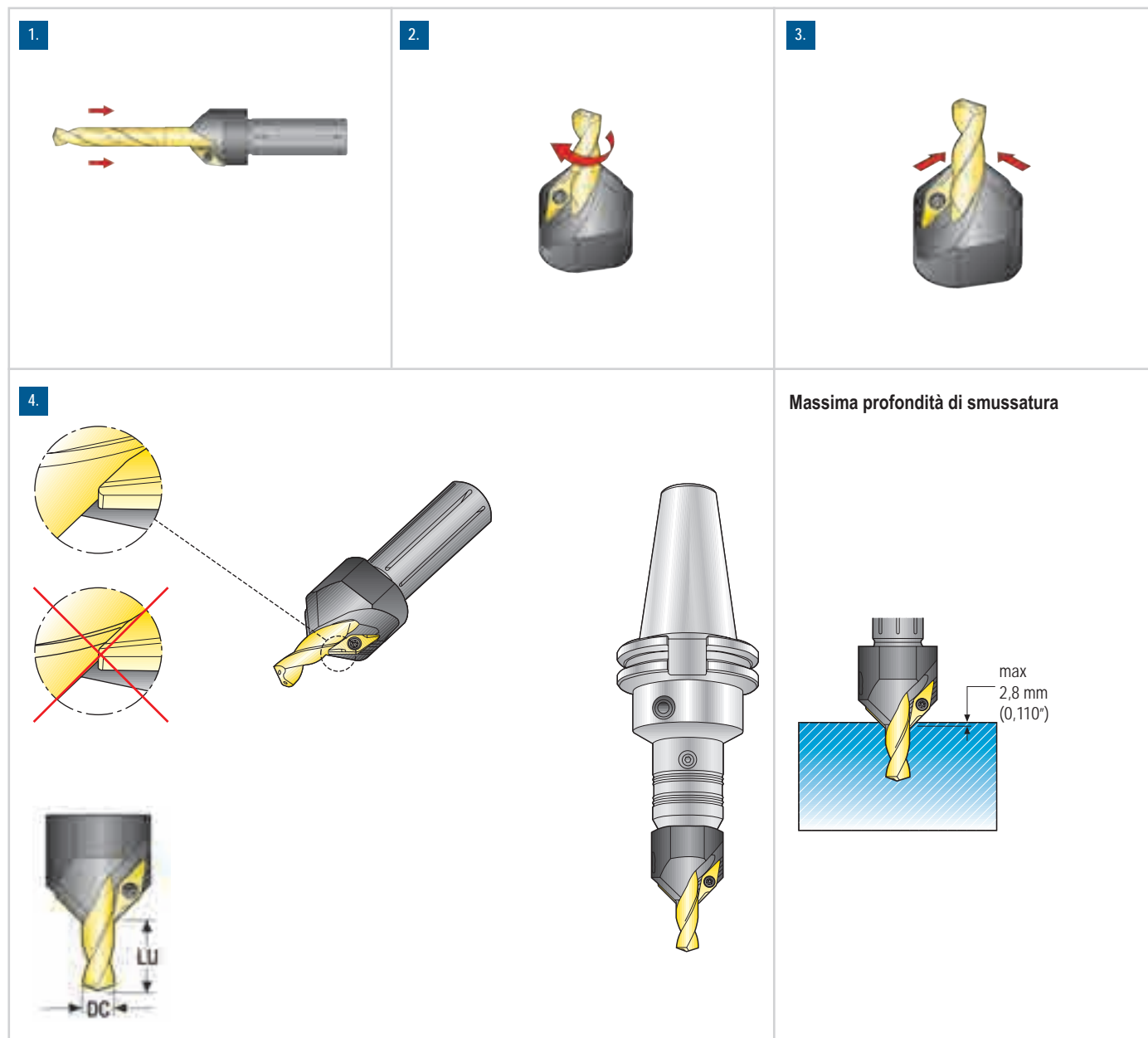

Diametro punta DC		LU profondità di foratura (min-max)					
		SD1103 / SD203A		SD1105 / SD205A		SD207A	
mm	inch	mm	inch	mm	inch	mm	inch
4,00-4,75	.157-.187	4-17	.157-.669	10-27	.394-1.063	30-45	1.181-1.772
4,76-6,00	.187-.236	6-20	.236-.787	18-32	.709-1.260	30-45	1.181-1.772
6,01-8,00	.241-.315	15-27	.590-1.063	28-42	1.102-1.653	42-57	1.653-2.244
8,01-10,00	.315-.394	17-31	.669-1.220	34-48	1.338-1.890	47-62	1.850-2.441
10,01-12,00	.394-.472	21-36	.826-1.417	40-56	1.575-2.205	57-72	2.244-2.835
12,01-14,00	.473-.551	22-37	.866-1.457	43-59	1.693-2.323	68-83	2.677-3.268
14,01-16,00	.552-.630	23-39	.906-1.535	44-60	1.732-2.362	76-92	2.992-3.622

Da utilizzare esclusivamente con attacco cilindrico (-R1).

Introduzione

Foratura

Alesatura

Barenatura

Allegato

SD203A, -MS

Profondità di foratura ~ 3 x D – Misure metriche/Pollici

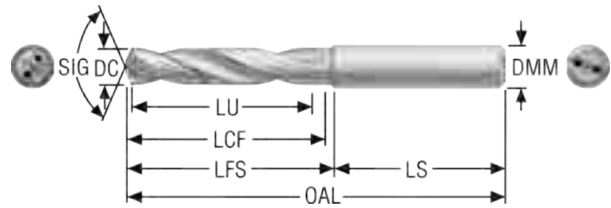

- Codolo cilindrico DIN 6537A
- Tolleranza DC m7
- Adduzione refrigerante interna
- Per i parametri di taglio raccomandati, vedere pagina(e) 157-158
- Per i diametri intermedi, utilizzare MyDesign.

Codice di ordinazione	Codice prodotto	DC	LU	OAL	LFS	LS	LCF	DMM	Angolo di punta	Rivestimento	Tolleranza foro
		mm Inch	mm Inch	mm Inch	mm Inch	mm Inch	mm Inch	mm Inch			
SD203A-0200-007-04R1-MS	10004064	2,0 0.079	7,0 0.276	41,0 1.614	14,0 0.551	27,0 1.063	11,0 0.433	4,0 0.157	140°	TiAIN + NbN	IT8-9
SD203A-0210-007-04R1-MS	10004065	2,1 0.083	7,0 0.276	41,0 1.614	14,0 0.551	27,0 1.063	11,0 0.433	4,0 0.157	140°	TiAIN + NbN	IT8-9
SD203A-0220-007-04R1-MS	10004066	2,2 0.087	7,0 0.276	41,0 1.614	14,0 0.551	27,0 1.063	11,0 0.433	4,0 0.157	140°	TiAIN + NbN	IT8-9
SD203A-0230-008-04R1-MS	10004067	2,3 0.091	8,0 0.315	44,0 1.732	17,0 0.669	27,0 1.063	12,5 0.492	4,0 0.157	140°	TiAIN + NbN	IT8-9
SD203A-0240-008-04R1-MS	10004068	2,4 0.094	8,0 0.315	44,0 1.732	17,0 0.669	27,0 1.063	12,5 0.492	4,0 0.157	140°	TiAIN + NbN	IT8-9
SD203A-0250-008-04R1-MS	10004072	2,5 0.098	8,0 0.315	44,0 1.732	17,0 0.669	27,0 1.063	12,5 0.492	4,0 0.157	140°	TiAIN + NbN	IT8-9
SD203A-0260-008-04R1-MS	10004073	2,6 0.102	8,0 0.315	44,0 1.732	17,0 0.669	27,0 1.063	12,5 0.492	4,0 0.157	140°	TiAIN + NbN	IT8-9
SD203A-0270-009-04R1-MS	10004074	2,7 0.106	9,0 0.354	44,0 1.732	17,0 0.669	27,0 1.063	14,5 0.571	4,0 0.157	140°	TiAIN + NbN	IT8-9
SD203A-0278-009-04R1-MS	10004075	2,78 0.109	9,0 0.354	44,0 1.732	17,0 0.669	27,0 1.063	14,5 0.571	4,0 0.157	140°	TiAIN + NbN	IT8-9
SD203A-0290-009-04R1-MS	10004076	2,9 0.114	9,0 0.354	44,0 1.732	17,0 0.669	27,0 1.063	14,5 0.571	4,0 0.157	140°	TiAIN + NbN	IT8-9
SD203A-0300-014-06R1-MS	10004077	3,0 0.118	14,0 0.551	62,0 2.441	26,0 1.024	36,0 1.417	20,0 0.787	6,0 0.236	140°	TiAIN + NbN	IT8-9
SD203A-0310-014-06R1-MS	10004078	3,1 0.122	14,0 0.551	62,0 2.441	26,0 1.024	36,0 1.417	20,0 0.787	6,0 0.236	140°	TiAIN + NbN	IT8-9
SD203A-0320-014-06R1-MS	10004079	3,2 0.126	14,0 0.551	62,0 2.441	26,0 1.024	36,0 1.417	20,0 0.787	6,0 0.236	140°	TiAIN + NbN	IT8-9
SD203A-0330-014-06R1-MS	10004080	3,3 0.130	14,0 0.551	62,0 2.441	26,0 1.024	36,0 1.417	20,0 0.787	6,0 0.236	140°	TiAIN + NbN	IT8-9
SD203A-0340-014-06R1-MS	10004081	3,4 0.134	14,0 0.551	62,0 2.441	26,0 1.024	36,0 1.417	20,0 0.787	6,0 0.236	140°	TiAIN + NbN	IT8-9
SD203A-0350-015-06R1-MS	10004083	3,5 0.138	15,0 0.591	62,0 2.441	26,0 1.024	36,0 1.417	20,0 0.787	6,0 0.236	140°	TiAIN + NbN	IT8-9
SD203A-0357-015-06R1-MS	10004084	3,57 0.141	15,0 0.591	62,0 2.441	26,0 1.024	36,0 1.417	20,0 0.787	6,0 0.236	140°	TiAIN + NbN	IT8-9
SD203A-0370-015-06R1-MS	10004085	3,7 0.146	15,0 0.591	62,0 2.441	26,0 1.024	36,0 1.417	20,0 0.787	6,0 0.236	140°	TiAIN + NbN	IT8-9
SD203A-0380-017-06R1-MS	10004086	3,8 0.150	17,0 0.669	66,0 2.598	30,0 1.181	36,0 1.417	24,0 0.945	6,0 0.236	140°	TiAIN + NbN	IT8-9
SD203A-0390-017-06R1-MS	10004087	3,9 0.154	17,0 0.669	66,0 2.598	30,0 1.181	36,0 1.417	24,0 0.945	6,0 0.236	140°	TiAIN + NbN	IT8-9
SD203A-0397-017-06R1-MS	10004088	3,97 0.156	17,0 0.669	66,0 2.598	30,0 1.181	36,0 1.417	24,0 0.945	6,0 0.236	140°	TiAIN + NbN	IT8-9
SD203A-0400-017-06R1-MS	10004089	4,0 0.157	17,0 0.669	66,0 2.598	30,0 1.181	36,0 1.417	24,0 0.945	6,0 0.236	140°	TiAIN + NbN	IT8-9

Introduzione

Foratura

Alesatura

Barenatura

Allegato

Codice di ordinazione	Codice prodotto	DC	LU	OAL	LFS	LS	LCF	DMM	Angolo di punta	Rivestimento	Tolleranza foro
		mm Inch	mm Inch	mm Inch	mm Inch	mm Inch	mm Inch	mm Inch			
SD203A-0410-017-06R1-MS	10004090	4,1 0.161	17,0 0.669	66,0 2.598	30,0 1.181	36,0 1.417	24,0 0.945	6,0 0.236	140°	TiAIN + NbN	IT8-9
SD203A-0420-017-06R1-MS	10004091	4,2 0.165	17,0 0.669	66,0 2.598	30,0 1.181	36,0 1.417	24,0 0.945	6,0 0.236	140°	TiAIN + NbN	IT8-9
SD203A-0430-018-06R1-MS	10004092	4,3 0.169	18,0 0.709	66,0 2.598	30,0 1.181	36,0 1.417	24,0 0.945	6,0 0.236	140°	TiAIN + NbN	IT8-9
SD203A-0450-018-06R1-MS	10004093	4,5 0.177	18,0 0.709	66,0 2.598	30,0 1.181	36,0 1.417	24,0 0.945	6,0 0.236	140°	TiAIN + NbN	IT8-9
SD203A-0460-018-06R1-MS	10004094	4,6 0.181	18,0 0.709	66,0 2.598	30,0 1.181	36,0 1.417	26,0 1.024	6,0 0.236	140°	TiAIN + NbN	IT8-9
SD203A-0465-018-06R1-MS	10004095	4,65 0.183	18,0 0.709	66,0 2.598	30,0 1.181	36,0 1.417	26,0 1.024	6,0 0.236	140°	TiAIN + NbN	IT8-9
SD203A-0470-018-06R1-MS	10004096	4,7 0.185	18,0 0.709	66,0 2.598	30,0 1.181	36,0 1.417	26,0 1.024	6,0 0.236	140°	TiAIN + NbN	IT8-9
SD203A-0476-020-06R1-MS	10004097	4,76 0.187	20,0 0.787	66,0 2.598	30,0 1.181	36,0 1.417	28,0 1.102	6,0 0.236	140°	TiAIN + NbN	IT8-9
SD203A-0480-020-06R1-MS	10004098	4,8 0.189	20,0 0.787	66,0 2.598	30,0 1.181	36,0 1.417	28,0 1.102	6,0 0.236	140°	TiAIN + NbN	IT8-9
SD203A-0490-020-06R1-MS	10004099	4,9 0.193	20,0 0.787	66,0 2.598	30,0 1.181	36,0 1.417	28,0 1.102	6,0 0.236	140°	TiAIN + NbN	IT8-9
SD203A-0500-020-06R1-MS	10004101	5,0 0.197	20,0 0.787	66,0 2.598	30,0 1.181	36,0 1.417	28,0 1.102	6,0 0.236	140°	TiAIN + NbN	IT8-9
SD203A-0510-020-06R1-MS	10004102	5,1 0.201	20,0 0.787	66,0 2.598	30,0 1.181	36,0 1.417	28,0 1.102	6,0 0.236	140°	TiAIN + NbN	IT8-9
SD203A-0516-020-06R1-MS	10004103	5,16 0.203	20,0 0.787	66,0 2.598	30,0 1.181	36,0 1.417	28,0 1.102	6,0 0.236	140°	TiAIN + NbN	IT8-9
SD203A-0520-020-06R1-MS	10004104	5,2 0.205	20,0 0.787	66,0 2.598	30,0 1.181	36,0 1.417	28,0 1.102	6,0 0.236	140°	TiAIN + NbN	IT8-9
SD203A-0530-020-06R1-MS	10004105	5,3 0.209	20,0 0.787	66,0 2.598	30,0 1.181	36,0 1.417	28,0 1.102	6,0 0.236	140°	TiAIN + NbN	IT8-9
SD203A-0540-020-06R1-MS	10004106	5,4 0.213	20,0 0.787	66,0 2.598	30,0 1.181	36,0 1.417	28,0 1.102	6,0 0.236	140°	TiAIN + NbN	IT8-9
SD203A-0550-020-06R1-MS	10004107	5,5 0.217	20,0 0.787	66,0 2.598	30,0 1.181	36,0 1.417	28,0 1.102	6,0 0.236	140°	TiAIN + NbN	IT8-9
SD203A-0556-020-06R1-MS	10004108	5,56 0.219	20,0 0.787	66,0 2.598	30,0 1.181	36,0 1.417	28,0 1.102	6,0 0.236	140°	TiAIN + NbN	IT8-9
SD203A-0560-021-06R1-MS	10004109	5,6 0.220	21,0 0.827	66,0 2.598	30,0 1.181	36,0 1.417	28,0 1.102	6,0 0.236	140°	TiAIN + NbN	IT8-9
SD203A-0570-021-06R1-MS	10004110	5,7 0.224	21,0 0.827	66,0 2.598	30,0 1.181	36,0 1.417	28,0 1.102	6,0 0.236	140°	TiAIN + NbN	IT8-9
SD203A-0580-021-06R1-MS	10004111	5,8 0.228	21,0 0.827	66,0 2.598	30,0 1.181	36,0 1.417	28,0 1.102	6,0 0.236	140°	TiAIN + NbN	IT8-9
SD203A-0590-021-06R1-MS	10004112	5,9 0.232	21,0 0.827	66,0 2.598	30,0 1.181	36,0 1.417	28,0 1.102	6,0 0.236	140°	TiAIN + NbN	IT8-9
SD203A-0595-021-06R1-MS	10004113	5,95 0.234	21,0 0.827	66,0 2.598	30,0 1.181	36,0 1.417	28,0 1.102	6,0 0.236	140°	TiAIN + NbN	IT8-9
SD203A-0600-021-06R1-MS	10004114	6,0 0.236	21,0 0.827	66,0 2.598	30,0 1.181	36,0 1.417	28,0 1.102	6,0 0.236	140°	TiAIN + NbN	IT8-9
SD203A-0610-021-08R1-MS	10004115	6,1 0.240	21,0 0.827	79,0 3.110	43,0 1.693	36,0 1.417	34,0 1.339	8,0 0.315	140°	TiAIN + NbN	IT8-9
SD203A-0620-021-08R1-MS	10004116	6,2 0.244	21,0 0.827	79,0 3.110	43,0 1.693	36,0 1.417	34,0 1.339	8,0 0.315	140°	TiAIN + NbN	IT8-9
SD203A-0630-021-08R1-MS	10004117	6,3 0.248	21,0 0.827	79,0 3.110	43,0 1.693	36,0 1.417	34,0 1.339	8,0 0.315	140°	TiAIN + NbN	IT8-9
SD203A-0635-023-08R1-MS	10004121	6,35 0.250	23,0 0.906	79,0 3.110	43,0 1.693	36,0 1.417	34,0 1.339	8,0 0.315	140°	TiAIN + NbN	IT8-9
SD203A-0650-023-08R1-MS	10004122	6,5 0.256	23,0 0.906	79,0 3.110	43,0 1.693	36,0 1.417	34,0 1.339	8,0 0.315	140°	TiAIN + NbN	IT8-9
SD203A-0660-023-08R1-MS	10004123	6,6 0.260	23,0 0.906	79,0 3.110	43,0 1.693	36,0 1.417	34,0 1.339	8,0 0.315	140°	TiAIN + NbN	IT8-9
SD203A-0675-025-08R1-MS	10004124	6,75 0.266	25,0 0.984	79,0 3.110	43,0 1.693	36,0 1.417	34,0 1.339	8,0 0.315	140°	TiAIN + NbN	IT8-9

Introduzione

Foratura

Alesatura

Barenatura

Allegato

Codice di ordinazione	Codice prodotto	DC	LU	OAL	LFS	LS	LCF	DMM	Angolo di punta	Rivestimento	Tolleranza foro
		mm Inch	mm Inch	mm Inch	mm Inch	mm Inch	mm Inch	mm Inch			
SD203A-0680-025-08R1-MS	10004125	6,8 0.268	25,0 0.984	79,0 3.110	43,0 1.693	36,0 1.417	34,0 1.339	8,0 0.315	140°	TiAIN + NbN	IT8-9
SD203A-0690-025-08R1-MS	10004127	6,9 0.272	25,0 0.984	79,0 3.110	43,0 1.693	36,0 1.417	34,0 1.339	8,0 0.315	140°	TiAIN + NbN	IT8-9
SD203A-0700-025-08R1-MS	10004128	7,0 0.276	25,0 0.984	79,0 3.110	43,0 1.693	36,0 1.417	34,0 1.339	8,0 0.315	140°	TiAIN + NbN	IT8-9
SD203A-0710-025-08R1-MS	10004129	7,1 0.280	25,0 0.984	79,0 3.110	43,0 1.693	36,0 1.417	41,0 1.614	8,0 0.315	140°	TiAIN + NbN	IT8-9
SD203A-0714-025-08R1-MS	10004130	7,14 0.281	25,0 0.984	79,0 3.110	43,0 1.693	36,0 1.417	41,0 1.614	8,0 0.315	140°	TiAIN + NbN	IT8-9
SD203A-0720-025-08R1-MS	10004132	7,2 0.283	25,0 0.984	79,0 3.110	43,0 1.693	36,0 1.417	41,0 1.614	8,0 0.315	140°	TiAIN + NbN	IT8-9
SD203A-0730-025-08R1-MS	10004133	7,3 0.287	25,0 0.984	79,0 3.110	43,0 1.693	36,0 1.417	41,0 1.614	8,0 0.315	140°	TiAIN + NbN	IT8-9
SD203A-0740-025-08R1-MS	10004134	7,4 0.291	25,0 0.984	79,0 3.110	43,0 1.693	36,0 1.417	41,0 1.614	8,0 0.315	140°	TiAIN + NbN	IT8-9
SD203A-0750-025-08R1-MS	10004135	7,5 0.295	25,0 0.984	79,0 3.110	43,0 1.693	36,0 1.417	41,0 1.614	8,0 0.315	140°	TiAIN + NbN	IT8-9
SD203A-0760-027-08R1-MS	10004136	7,6 0.299	27,0 1.063	79,0 3.110	43,0 1.693	36,0 1.417	41,0 1.614	8,0 0.315	140°	TiAIN + NbN	IT8-9
SD203A-0780-027-08R1-MS	10004137	7,8 0.307	27,0 1.063	79,0 3.110	43,0 1.693	36,0 1.417	41,0 1.614	8,0 0.315	140°	TiAIN + NbN	IT8-9
SD203A-0794-027-08R1-MS	10004138	7,94 0.313	27,0 1.063	79,0 3.110	43,0 1.693	36,0 1.417	41,0 1.614	8,0 0.315	140°	TiAIN + NbN	IT8-9
SD203A-0800-027-08R1-MS	10004139	8,0 0.315	27,0 1.063	79,0 3.110	43,0 1.693	36,0 1.417	41,0 1.614	8,0 0.315	140°	TiAIN + NbN	IT8-9
SD203A-0810-027-10R1-MS	10004140	8,1 0.319	27,0 1.063	89,0 3.504	49,0 1.929	40,0 1.575	47,0 1.850	10,0 0.394	140°	TiAIN + NbN	IT8-9
SD203A-0820-027-10R1-MS	10004141	8,2 0.323	27,0 1.063	89,0 3.504	49,0 1.929	40,0 1.575	47,0 1.850	10,0 0.394	140°	TiAIN + NbN	IT8-9
SD203A-0830-027-10R1-MS	10004143	8,3 0.327	27,0 1.063	89,0 3.504	49,0 1.929	40,0 1.575	47,0 1.850	10,0 0.394	140°	TiAIN + NbN	IT8-9
SD203A-0840-027-10R1-MS	10004144	8,4 0.331	27,0 1.063	89,0 3.504	49,0 1.929	40,0 1.575	47,0 1.850	10,0 0.394	140°	TiAIN + NbN	IT8-9
SD203A-0850-027-10R1-MS	10004146	8,5 0.335	27,0 1.063	89,0 3.504	49,0 1.929	40,0 1.575	47,0 1.850	10,0 0.394	140°	TiAIN + NbN	IT8-9
SD203A-0860-029-10R1-MS	10004147	8,6 0.339	29,0 1.142	89,0 3.504	49,0 1.929	40,0 1.575	47,0 1.850	10,0 0.394	140°	TiAIN + NbN	IT8-9
SD203A-0870-029-10R1-MS	10004148	8,7 0.343	29,0 1.142	89,0 3.504	49,0 1.929	40,0 1.575	47,0 1.850	10,0 0.394	140°	TiAIN + NbN	IT8-9
SD203A-0873-029-10R1-MS	10004149	8,73 0.344	29,0 1.142	89,0 3.504	49,0 1.929	40,0 1.575	47,0 1.850	10,0 0.394	140°	TiAIN + NbN	IT8-9
SD203A-0880-029-10R1-MS	10004150	8,8 0.346	29,0 1.142	89,0 3.504	49,0 1.929	40,0 1.575	47,0 1.850	10,0 0.394	140°	TiAIN + NbN	IT8-9
SD203A-0900-029-10R1-MS	10004151	9,0 0.354	29,0 1.142	89,0 3.504	49,0 1.929	40,0 1.575	47,0 1.850	10,0 0.394	140°	TiAIN + NbN	IT8-9
SD203A-0910-029-10R1-MS	10004153	9,1 0.358	29,0 1.142	89,0 3.504	49,0 1.929	40,0 1.575	47,0 1.850	10,0 0.394	140°	TiAIN + NbN	IT8-9
SD203A-0913-029-10R1-MS	10004154	9,13 0.359	29,0 1.142	89,0 3.504	49,0 1.929	40,0 1.575	47,0 1.850	10,0 0.394	140°	TiAIN + NbN	IT8-9
SD203A-0920-029-10R1-MS	10004156	9,2 0.362	29,0 1.142	89,0 3.504	49,0 1.929	40,0 1.575	47,0 1.850	10,0 0.394	140°	TiAIN + NbN	IT8-9
SD203A-0930-029-10R1-MS	10004157	9,3 0.366	29,0 1.142	89,0 3.504	49,0 1.929	40,0 1.575	47,0 1.850	10,0 0.394	140°	TiAIN + NbN	IT8-9
SD203A-0950-029-10R1-MS	10004158	9,5 0.374	29,0 1.142	89,0 3.504	49,0 1.929	40,0 1.575	47,0 1.850	10,0 0.394	140°	TiAIN + NbN	IT8-9
SD203A-0953-031-10R1-MS	10004160	9,53 0.375	31,0 1.220	89,0 3.504	49,0 1.929	40,0 1.575	47,0 1.850	10,0 0.394	140°	TiAIN + NbN	IT8-9
SD203A-0970-031-10R1-MS	10004161	9,7 0.382	31,0 1.220	89,0 3.504	49,0 1.929	40,0 1.575	47,0 1.850	10,0 0.394	140°	TiAIN + NbN	IT8-9
SD203A-0980-031-10R1-MS	10004162	9,8 0.386	31,0 1.220	89,0 3.504	49,0 1.929	40,0 1.575	47,0 1.850	10,0 0.394	140°	TiAIN + NbN	IT8-9

Codice di ordinazione	Codice prodotto	DC	LU	OAL	LFS	LS	LCF	DMM	Angolo di punta	Rivestimento	Tolleranza foro
		mm Inch	mm Inch	mm Inch	mm Inch	mm Inch	mm Inch	mm Inch			
SD203A-0990-031-10R1-MS	10004163	9,9 0.390	31,0 1.220	89,0 3.504	49,0 1.929	40,0 1.575	47,0 1.850	10,0 0.394	140°	TiAIN + NbN	IT8-9
SD203A-0992-031-10R1-MS	10004164	9,92 0.391	31,0 1.220	89,0 3.504	49,0 1.929	40,0 1.575	47,0 1.850	10,0 0.394	140°	TiAIN + NbN	IT8-9
SD203A-1000-031-10R1-MS	10004165	10,0 0.394	31,0 1.220	89,0 3.504	49,0 1.929	40,0 1.575	47,0 1.850	10,0 0.394	140°	TiAIN + NbN	IT8-9
SD203A-1010-031-12R1-MS	10004166	10,1 0.398	31,0 1.220	102,0 4.016	57,0 2.244	45,0 1.772	55,0 2.165	12,0 0.472	140°	TiAIN + NbN	IT8-9
SD203A-1020-031-12R1-MS	10004167	10,2 0.402	31,0 1.220	102,0 4.016	57,0 2.244	45,0 1.772	55,0 2.165	12,0 0.472	140°	TiAIN + NbN	IT8-9
SD203A-1032-031-12R1-MS	10004168	10,32 0.406	31,0 1.220	102,0 4.016	57,0 2.244	45,0 1.772	55,0 2.165	12,0 0.472	140°	TiAIN + NbN	IT8-9
SD203A-1040-031-12R1-MS	10004169	10,4 0.409	31,0 1.220	102,0 4.016	57,0 2.244	45,0 1.772	55,0 2.165	12,0 0.472	140°	TiAIN + NbN	IT8-9
SD203A-1050-031-12R1-MS	10004170	10,5 0.413	31,0 1.220	102,0 4.016	57,0 2.244	45,0 1.772	55,0 2.165	12,0 0.472	140°	TiAIN + NbN	IT8-9
SD203A-1072-033-12R1-MS	10004171	10,72 0.422	33,0 1.299	102,0 4.016	57,0 2.244	45,0 1.772	55,0 2.165	12,0 0.472	140°	TiAIN + NbN	IT8-9
SD203A-1080-033-12R1-MS	10004172	10,8 0.425	33,0 1.299	102,0 4.016	57,0 2.244	45,0 1.772	55,0 2.165	12,0 0.472	140°	TiAIN + NbN	IT8-9
SD203A-1100-033-12R1-MS	10004173	11,0 0.433	33,0 1.299	102,0 4.016	57,0 2.244	45,0 1.772	55,0 2.165	12,0 0.472	140°	TiAIN + NbN	IT8-9
SD203A-1111-033-12R1-MS	10004174	11,11 0.437	33,0 1.299	102,0 4.016	57,0 2.244	45,0 1.772	55,0 2.165	12,0 0.472	140°	TiAIN + NbN	IT8-9
SD203A-1120-033-12R1-MS	10004175	11,2 0.441	33,0 1.299	102,0 4.016	57,0 2.244	45,0 1.772	55,0 2.165	12,0 0.472	140°	TiAIN + NbN	IT8-9
SD203A-1150-033-12R1-MS	10004176	11,5 0.453	33,0 1.299	102,0 4.016	57,0 2.244	45,0 1.772	55,0 2.165	12,0 0.472	140°	TiAIN + NbN	IT8-9
SD203A-1180-033-12R1-MS	10004177	11,8 0.465	33,0 1.299	102,0 4.016	57,0 2.244	45,0 1.772	55,0 2.165	12,0 0.472	140°	TiAIN + NbN	IT8-9
SD203A-1191-036-12R1-MS	10004309	11,91 0.469	36,0 1.417	102,0 4.016	57,0 2.244	45,0 1.772	55,0 2.165	12,0 0.472	140°	TiAIN + NbN	IT8-9
SD203A-1200-036-12R1-MS	10004314	12,0 0.472	36,0 1.417	102,0 4.016	57,0 2.244	45,0 1.772	55,0 2.165	12,0 0.472	140°	TiAIN + NbN	IT8-9
SD203A-1210-036-14R1-MS	10004315	12,1 0.476	36,0 1.417	107,0 4.213	62,0 2.441	45,0 1.772	60,0 2.362	14,0 0.551	140°	TiAIN + NbN	IT8-9
SD203A-1250-036-14R1-MS	10004316	12,5 0.492	36,0 1.417	107,0 4.213	62,0 2.441	45,0 1.772	60,0 2.362	14,0 0.551	140°	TiAIN + NbN	IT8-9
SD203A-1270-036-14R1-MS	10004317	12,7 0.500	36,0 1.417	107,0 4.213	62,0 2.441	45,0 1.772	60,0 2.362	14,0 0.551	140°	TiAIN + NbN	IT8-9
SD203A-1300-036-14R1-MS	10004319	13,0 0.512	36,0 1.417	107,0 4.213	62,0 2.441	45,0 1.772	60,0 2.362	14,0 0.551	140°	TiAIN + NbN	IT8-9
SD203A-1310-036-14R1-MS	10004320	13,1 0.516	36,0 1.417	107,0 4.213	62,0 2.441	45,0 1.772	60,0 2.362	14,0 0.551	140°	TiAIN + NbN	IT8-9
SD203A-1350-037-14R1-MS	10004321	13,5 0.531	37,0 1.457	107,0 4.213	62,0 2.441	45,0 1.772	60,0 2.362	14,0 0.551	140°	TiAIN + NbN	IT8-9
SD203A-1400-037-14R1-MS	10004325	14,0 0.551	37,0 1.457	107,0 4.213	62,0 2.441	45,0 1.772	60,0 2.362	14,0 0.551	140°	TiAIN + NbN	IT8-9
SD203A-1420-037-16R1-MS	10004332	14,2 0.559	37,0 1.457	115,0 4.528	67,0 2.638	48,0 1.890	65,0 2.559	16,0 0.630	140°	TiAIN + NbN	IT8-9
SD203A-1425-038-16R1-MS	10004333	14,25 0.561	38,0 1.496	115,0 4.528	67,0 2.638	48,0 1.890	65,0 2.559	16,0 0.630	140°	TiAIN + NbN	IT8-9
SD203A-1470-038-16R1-MS	10004334	14,7 0.579	38,0 1.496	115,0 4.528	67,0 2.638	48,0 1.890	65,0 2.559	16,0 0.630	140°	TiAIN + NbN	IT8-9
SD203A-1500-040-16R1-MS	10004335	15,0 0.591	40,0 1.575	115,0 4.528	67,0 2.638	48,0 1.890	65,0 2.559	16,0 0.630	140°	TiAIN + NbN	IT8-9
SD203A-1525-040-16R1-MS	10004336	15,25 0.600	40,0 1.575	115,0 4.528	67,0 2.638	48,0 1.890	65,0 2.559	16,0 0.630	140°	TiAIN + NbN	IT8-9
SD203A-1550-040-16R1-MS	10004338	15,5 0.610	40,0 1.575	115,0 4.528	67,0 2.638	48,0 1.890	65,0 2.559	16,0 0.630	140°	TiAIN + NbN	IT8-9
SD203A-1588-040-16R1-MS	10004339	15,88 0.625	40,0 1.575	115,0 4.528	67,0 2.638	48,0 1.890	65,0 2.559	16,0 0.630	140°	TiAIN + NbN	IT8-9

Introduzione

Foratura

Alesatura

Barenatura

Allegato

Codice di ordinazione	Codice prodotto	DC	LU	OAL	LFS	LS	LCF	DMM	Angolo di punta	Rivestimento	Tolleranza foro
		mm Inch	mm Inch	mm Inch	mm Inch	mm Inch	mm Inch	mm Inch			
SD203A-1600-040-16R1-MS	10004340	16,0 0.630	40,0 1.575	115,0 4.528	67,0 2.638	48,0 1.890	65,0 2.559	16,0 0.630	140°	TiAIN + NbN	IT8-9
SD203A-1650-045-18R1-MS	10004341	16,5 0.650	45,0 1.772	123,0 4.843	75,0 2.953	48,0 1.890	73,0 2.874	18,0 0.709	140°	TiAIN + NbN	IT8-9
SD203A-1700-045-18R1-MS	10004342	17,0 0.669	45,0 1.772	123,0 4.843	75,0 2.953	48,0 1.890	73,0 2.874	18,0 0.709	140°	TiAIN + NbN	IT8-9
SD203A-1750-045-18R1-MS	10004343	17,5 0.689	45,0 1.772	123,0 4.843	75,0 2.953	48,0 1.890	73,0 2.874	18,0 0.709	140°	TiAIN + NbN	IT8-9
SD203A-1800-045-18R1-MS	10004344	18,0 0.709	45,0 1.772	123,0 4.843	75,0 2.953	48,0 1.890	73,0 2.874	18,0 0.709	140°	TiAIN + NbN	IT8-9
SD203A-1850-050-20R1-MS	10004345	18,5 0.728	50,0 1.969	131,0 5.157	81,0 3.189	50,0 1.969	79,0 3.110	20,0 0.787	140°	TiAIN + NbN	IT8-9
SD203A-1900-050-20R1-MS	10004346	19,0 0.748	50,0 1.969	131,0 5.157	81,0 3.189	50,0 1.969	79,0 3.110	20,0 0.787	140°	TiAIN + NbN	IT8-9
SD203A-1905-050-20R1-MS	10004347	19,05 0.750	50,0 1.969	131,0 5.157	81,0 3.189	50,0 1.969	79,0 3.110	20,0 0.787	140°	TiAIN + NbN	IT8-9
SD203A-1950-050-20R1-MS	10004348	19,5 0.768	50,0 1.969	131,0 5.157	81,0 3.189	50,0 1.969	79,0 3.110	20,0 0.787	140°	TiAIN + NbN	IT8-9
SD203A-2000-050-20R1-MS	10004349	20,0 0.787	50,0 1.969	131,0 5.157	81,0 3.189	50,0 1.969	79,0 3.110	20,0 0.787	140°	TiAIN + NbN	IT8-9

Introduzione

Foratura

Alésatura

Barenatura

Allegato

SD205A, -MS

Profondità di foratura ~ 5 x D – Misure metriche/Pollici

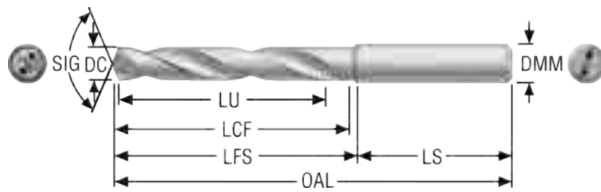

- Codolo cilindrico DIN 6537A
- Tolleranza DC m7
- Adduzione refrigerante interna
- Per i parametri di taglio raccomandati, vedere pagina(e) 159-160
- Per i diametri intermedi, utilizzare MyDesign.

Codice di ordinazione	Codice prodotto	DC	LU	OAL	LFS	LS	LCF	DMM	Angolo di punta	Rivestimento	Tolleranza foro
		mm Inch	mm Inch	mm Inch	mm Inch	mm Inch	mm Inch	mm Inch			
SD205A-0200-012-04R1-MS	10004179	2,0 0.079	12,0 0.472	46,0 1.811	19,0 0.748	27,0 1.063	15,0 0.591	4,0 0.157	140°	TiAlN + NbN	IT8-9
SD205A-0210-012-04R1-MS	10004180	2,1 0.083	12,0 0.472	46,0 1.811	19,0 0.748	27,0 1.063	15,0 0.591	4,0 0.157	140°	TiAlN + NbN	IT8-9
SD205A-0220-012-04R1-MS	10004181	2,2 0.087	12,0 0.472	46,0 1.811	19,0 0.748	27,0 1.063	15,0 0.591	4,0 0.157	140°	TiAlN + NbN	IT8-9
SD205A-0230-012-04R1-MS	10004182	2,3 0.091	12,0 0.472	46,0 1.811	19,0 0.748	27,0 1.063	15,0 0.591	4,0 0.157	140°	TiAlN + NbN	IT8-9
SD205A-0240-013-04R1-MS	10004183	2,4 0.094	13,0 0.512	50,0 1.969	23,0 0.906	27,0 1.063	17,5 0.689	4,0 0.157	140°	TiAlN + NbN	IT8-9
SD205A-0250-013-04R1-MS	10004184	2,5 0.098	13,0 0.512	50,0 1.969	23,0 0.906	27,0 1.063	17,5 0.689	4,0 0.157	140°	TiAlN + NbN	IT8-9
SD205A-0260-013-04R1-MS	10004185	2,6 0.102	13,0 0.512	50,0 1.969	23,0 0.906	27,0 1.063	17,5 0.689	4,0 0.157	140°	TiAlN + NbN	IT8-9
SD205A-0270-013-04R1-MS	10004186	2,7 0.106	15,0 0.591	50,0 1.969	23,0 0.906	27,0 1.063	20,5 0.807	4,0 0.157	140°	TiAlN + NbN	IT8-9
SD205A-0280-013-04R1-MS	10004187	2,8 0.110	15,0 0.591	50,0 1.969	23,0 0.906	27,0 1.063	20,5 0.807	4,0 0.157	140°	TiAlN + NbN	IT8-9
SD205A-0300-021-06R1-MS	10004188	3,0 0.118	21,0 0.827	66,0 2.598	30,0 1.181	36,0 1.417	26,0 1.024	6,0 0.236	140°	TiAlN + NbN	IT8-9
SD205A-0310-021-06R1-MS	10004189	3,1 0.122	21,0 0.827	66,0 2.598	30,0 1.181	36,0 1.417	26,0 1.024	6,0 0.236	140°	TiAlN + NbN	IT8-9
SD205A-0318-021-06R1-MS	10004191	3,18 0.125	21,0 0.827	66,0 2.598	30,0 1.181	36,0 1.417	26,0 1.024	6,0 0.236	140°	TiAlN + NbN	IT8-9
SD205A-0330-021-06R1-MS	10004192	3,3 0.130	21,0 0.827	66,0 2.598	30,0 1.181	36,0 1.417	26,0 1.024	6,0 0.236	140°	TiAlN + NbN	IT8-9
SD205A-0340-021-06R1-MS	10004193	3,4 0.134	21,0 0.827	66,0 2.598	30,0 1.181	36,0 1.417	26,0 1.024	6,0 0.236	140°	TiAlN + NbN	IT8-9
SD205A-0350-021-06R1-MS	10004194	3,5 0.138	21,0 0.827	66,0 2.598	30,0 1.181	36,0 1.417	26,0 1.024	6,0 0.236	140°	TiAlN + NbN	IT8-9
SD205A-0360-027-06R1-MS	10004195	3,6 0.142	21,0 0.827	66,0 2.598	30,0 1.181	36,0 1.417	26,0 1.024	6,0 0.236	140°	TiAlN + NbN	IT8-9
SD205A-0380-027-06R1-MS	10004196	3,8 0.150	27,0 1.063	74,0 2.913	38,0 1.496	36,0 1.417	34,0 1.339	6,0 0.236	140°	TiAlN + NbN	IT8-9
SD205A-0390-027-06R1-MS	10004197	3,9 0.154	27,0 1.063	74,0 2.913	38,0 1.496	36,0 1.417	34,0 1.339	6,0 0.236	140°	TiAlN + NbN	IT8-9
SD205A-0400-027-06R1-MS	10004198	4,0 0.157	27,0 1.063	74,0 2.913	38,0 1.496	36,0 1.417	34,0 1.339	6,0 0.236	140°	TiAlN + NbN	IT8-9
SD205A-0410-027-06R1-MS	10004199	4,1 0.161	27,0 1.063	74,0 2.913	38,0 1.496	36,0 1.417	34,0 1.339	6,0 0.236	140°	TiAlN + NbN	IT8-9
SD205A-0420-027-06R1-MS	10004200	4,2 0.165	27,0 1.063	74,0 2.913	38,0 1.496	36,0 1.417	34,0 1.339	6,0 0.236	140°	TiAlN + NbN	IT8-9
SD205A-0430-027-06R1-MS	10004201	4,3 0.169	27,0 1.063	74,0 2.913	38,0 1.496	36,0 1.417	34,0 1.339	6,0 0.236	140°	TiAlN + NbN	IT8-9

Codice di ordinazione	Codice prodotto	DC	LU	OAL	LFS	LS	LCF	DMM	Angolo di punta	Rivestimento	Tolleranza foro
		mm Inch	mm Inch	mm Inch	mm Inch	mm Inch	mm Inch	mm Inch			
SD205A-0450-027-06R1-MS	10004202	4,5 0.177	27,0 1.063	74,0 2.913	38,0 1.496	36,0 1.417	34,0 1.339	6,0 0.236	140°	TiAlN + NbN	IT8-9
SD205A-0460-027-06R1-MS	10004203	4,6 0.181	27,0 1.063	74,0 2.913	38,0 1.496	36,0 1.417	34,0 1.339	6,0 0.236	140°	TiAlN + NbN	IT8-9
SD205A-0465-027-06R1-MS	10004205	4,65 0.183	27,0 1.063	74,0 2.913	38,0 1.496	36,0 1.417	34,0 1.339	6,0 0.236	140°	TiAlN + NbN	IT8-9
SD205A-0470-027-06R1-MS	10004206	4,7 0.185	27,0 1.063	74,0 2.913	38,0 1.496	36,0 1.417	34,0 1.339	6,0 0.236	140°	TiAlN + NbN	IT8-9
SD205A-0476-027-06R1-MS	10004208	4,76 0.187	32,0 1.260	82,0 3.228	46,0 1.811	36,0 1.417	44,0 1.732	6,0 0.236	140°	TiAlN + NbN	IT8-9
SD205A-0490-032-06R1-MS	10004209	4,9 0.193	32,0 1.260	82,0 3.228	46,0 1.811	36,0 1.417	44,0 1.732	6,0 0.236	140°	TiAlN + NbN	IT8-9
SD205A-0500-032-06R1-MS	10004211	5,0 0.197	32,0 1.260	82,0 3.228	46,0 1.811	36,0 1.417	44,0 1.732	6,0 0.236	140°	TiAlN + NbN	IT8-9
SD205A-0510-032-06R1-MS	10004212	5,1 0.201	32,0 1.260	82,0 3.228	46,0 1.811	36,0 1.417	44,0 1.732	6,0 0.236	140°	TiAlN + NbN	IT8-9
SD205A-0516-032-06R1-MS	10004213	5,16 0.203	32,0 1.260	82,0 3.228	46,0 1.811	36,0 1.417	44,0 1.732	6,0 0.236	140°	TiAlN + NbN	IT8-9
SD205A-0520-032-06R1-MS	10004214	5,2 0.205	32,0 1.260	82,0 3.228	46,0 1.811	36,0 1.417	44,0 1.732	6,0 0.236	140°	TiAlN + NbN	IT8-9
SD205A-0550-032-06R1-MS	10004215	5,5 0.217	32,0 1.260	82,0 3.228	46,0 1.811	36,0 1.417	44,0 1.732	6,0 0.236	140°	TiAlN + NbN	IT8-9
SD205A-0556-032-06R1-MS	10004216	5,56 0.219	32,0 1.260	82,0 3.228	46,0 1.811	36,0 1.417	44,0 1.732	6,0 0.236	140°	TiAlN + NbN	IT8-9
SD205A-0560-032-06R1-MS	10004218	5,6 0.220	32,0 1.260	82,0 3.228	46,0 1.811	36,0 1.417	44,0 1.732	6,0 0.236	140°	TiAlN + NbN	IT8-9
SD205A-0580-032-06R1-MS	10004219	5,8 0.228	32,0 1.260	82,0 3.228	46,0 1.811	36,0 1.417	44,0 1.732	6,0 0.236	140°	TiAlN + NbN	IT8-9
SD205A-0590-032-06R1-MS	10004220	5,9 0.232	32,0 1.260	82,0 3.228	46,0 1.811	36,0 1.417	44,0 1.732	6,0 0.236	140°	TiAlN + NbN	IT8-9
SD205A-0595-032-06R1-MS	10004221	5,95 0.234	32,0 1.260	82,0 3.228	46,0 1.811	36,0 1.417	44,0 1.732	6,0 0.236	140°	TiAlN + NbN	IT8-9
SD205A-0600-032-06R1-MS	10004222	6,0 0.236	32,0 1.260	82,0 3.228	46,0 1.811	36,0 1.417	44,0 1.732	6,0 0.236	140°	TiAlN + NbN	IT8-9
SD205A-0620-035-08R1-MS	10004224	6,2 0.244	35,0 1.378	91,0 3.583	55,0 2.165	36,0 1.417	53,0 2.087	8,0 0.315	140°	TiAlN + NbN	IT8-9
SD205A-0630-035-08R1-MS	10004225	6,3 0.248	35,0 1.378	91,0 3.583	55,0 2.165	36,0 1.417	53,0 2.087	8,0 0.315	140°	TiAlN + NbN	IT8-9
SD205A-0635-035-08R1-MS	10004226	6,35 0.250	35,0 1.378	91,0 3.583	55,0 2.165	36,0 1.417	53,0 2.087	8,0 0.315	140°	TiAlN + NbN	IT8-9
SD205A-0640-035-08R1-MS	10004227	6,4 0.252	35,0 1.378	91,0 3.583	55,0 2.165	36,0 1.417	53,0 2.087	8,0 0.315	140°	TiAlN + NbN	IT8-9
SD205A-0650-035-08R1-MS	10004228	6,5 0.256	35,0 1.378	91,0 3.583	55,0 2.165	36,0 1.417	53,0 2.087	8,0 0.315	140°	TiAlN + NbN	IT8-9
SD205A-0660-035-08R1-MS	10004229	6,6 0.260	35,0 1.378	91,0 3.583	55,0 2.165	36,0 1.417	53,0 2.087	8,0 0.315	140°	TiAlN + NbN	IT8-9
SD205A-0670-035-08R1-MS	10004231	6,7 0.264	35,0 1.378	91,0 3.583	55,0 2.165	36,0 1.417	53,0 2.087	8,0 0.315	140°	TiAlN + NbN	IT8-9
SD205A-0680-040-08R1-MS	10004234	6,8 0.268	40,0 1.575	91,0 3.583	55,0 2.165	36,0 1.417	53,0 2.087	8,0 0.315	140°	TiAlN + NbN	IT8-9
SD205A-0690-040-08R1-MS	10004235	6,9 0.272	40,0 1.575	91,0 3.583	55,0 2.165	36,0 1.417	53,0 2.087	8,0 0.315	140°	TiAlN + NbN	IT8-9
SD205A-0700-040-08R1-MS	10004236	7,0 0.276	40,0 1.575	91,0 3.583	55,0 2.165	36,0 1.417	53,0 2.087	8,0 0.315	140°	TiAlN + NbN	IT8-9
SD205A-0710-040-08R1-MS	10004237	7,1 0.280	40,0 1.575	91,0 3.583	55,0 2.165	36,0 1.417	53,0 2.087	8,0 0.315	140°	TiAlN + NbN	IT8-9
SD205A-0714-040-08R1-MS	10004238	7,14 0.281	40,0 1.575	91,0 3.583	55,0 2.165	36,0 1.417	53,0 2.087	8,0 0.315	140°	TiAlN + NbN	IT8-9
SD205A-0720-040-08R1-MS	10004239	7,2 0.283	40,0 1.575	91,0 3.583	55,0 2.165	36,0 1.417	53,0 2.087	8,0 0.315	140°	TiAlN + NbN	IT8-9
SD205A-0750-040-08R1-MS	10004240	7,5 0.295	40,0 1.575	91,0 3.583	55,0 2.165	36,0 1.417	53,0 2.087	8,0 0.315	140°	TiAlN + NbN	IT8-9

Codice di ordinazione	Codice prodotto	DC	LU	OAL	LFS	LS	LCF	DMM	Angolo di punta	Rivestimento	Tolleranza foro
		mm Inch	mm Inch	mm Inch	mm Inch	mm Inch	mm Inch	mm Inch			
SD205A-0780-042-08R1-MS	10004241	7,8 0.307	42,0 1.654	91,0 3.583	55,0 2.165	36,0 1.417	53,0 2.087	8,0 0.315	140°	TiAIN + NbN	IT8-9
SD205A-0794-042-08R1-MS	10004243	7,94 0.313	42,0 1.654	91,0 3.583	55,0 2.165	36,0 1.417	53,0 2.087	8,0 0.315	140°	TiAIN + NbN	IT8-9
SD205A-0800-042-08R1-MS	10004245	8,0 0.315	42,0 1.654	91,0 3.583	55,0 2.165	36,0 1.417	53,0 2.087	8,0 0.315	140°	TiAIN + NbN	IT8-9
SD205A-0810-042-10R1-MS	10004246	8,1 0.319	42,0 1.654	103,0 4.055	63,0 2.480	40,0 1.575	61,0 2.402	10,0 0.394	140°	TiAIN + NbN	IT8-9
SD205A-0820-042-10R1-MS	10004247	8,2 0.323	42,0 1.654	103,0 4.055	63,0 2.480	40,0 1.575	61,0 2.402	10,0 0.394	140°	TiAIN + NbN	IT8-9
SD205A-0840-042-10R1-MS	10004250	8,4 0.331	42,0 1.654	103,0 4.055	63,0 2.480	40,0 1.575	61,0 2.402	10,0 0.394	140°	TiAIN + NbN	IT8-9
SD205A-0850-042-10R1-MS	10004251	8,5 0.335	42,0 1.654	103,0 4.055	63,0 2.480	40,0 1.575	61,0 2.402	10,0 0.394	140°	TiAIN + NbN	IT8-9
SD205A-0870-045-10R1-MS	10004252	8,7 0.343	45,0 1.772	103,0 4.055	63,0 2.480	40,0 1.575	61,0 2.402	10,0 0.394	140°	TiAIN + NbN	IT8-9
SD205A-0880-045-10R1-MS	10004255	8,8 0.346	45,0 1.772	103,0 4.055	63,0 2.480	40,0 1.575	61,0 2.402	10,0 0.394	140°	TiAIN + NbN	IT8-9
SD205A-0900-045-10R1-MS	10004256	9,0 0.354	45,0 1.772	103,0 4.055	63,0 2.480	40,0 1.575	61,0 2.402	10,0 0.394	140°	TiAIN + NbN	IT8-9
SD205A-0910-045-10R1-MS	10004257	9,1 0.358	45,0 1.772	103,0 4.055	63,0 2.480	40,0 1.575	61,0 2.402	10,0 0.394	140°	TiAIN + NbN	IT8-9
SD205A-0950-045-10R1-MS	10004258	9,5 0.374	45,0 1.772	103,0 4.055	63,0 2.480	40,0 1.575	61,0 2.402	10,0 0.394	140°	TiAIN + NbN	IT8-9
SD205A-0953-048-10R1-MS	10004259	9,53 0.375	48,0 1.890	103,0 4.055	63,0 2.480	40,0 1.575	61,0 2.402	10,0 0.394	140°	TiAIN + NbN	IT8-9
SD205A-0980-048-10R1-MS	10004266	9,8 0.386	48,0 1.890	103,0 4.055	63,0 2.480	40,0 1.575	61,0 2.402	10,0 0.394	140°	TiAIN + NbN	IT8-9
SD205A-0992-048-10R1-MS	10004269	9,92 0.391	48,0 1.890	103,0 4.055	63,0 2.480	40,0 1.575	61,0 2.402	10,0 0.394	140°	TiAIN + NbN	IT8-9
SD205A-1000-048-10R1-MS	10004270	10,0 0.394	48,0 1.890	103,0 4.055	63,0 2.480	40,0 1.575	61,0 2.402	10,0 0.394	140°	TiAIN + NbN	IT8-9
SD205A-1020-048-12R1-MS	10004272	10,2 0.402	48,0 1.890	118,0 4.646	73,0 2.874	45,0 1.772	71,0 2.795	12,0 0.472	140°	TiAIN + NbN	IT8-9
SD205A-1030-048-12R1-MS	10004273	10,3 0.406	48,0 1.890	118,0 4.646	73,0 2.874	45,0 1.772	71,0 2.795	12,0 0.472	140°	TiAIN + NbN	IT8-9
SD205A-1050-048-12R1-MS	10004274	10,5 0.413	48,0 1.890	118,0 4.646	73,0 2.874	45,0 1.772	71,0 2.795	12,0 0.472	140°	TiAIN + NbN	IT8-9
SD205A-1070-056-12R1-MS	10004275	10,7 0.421	56,0 2.205	118,0 4.646	73,0 2.874	45,0 1.772	71,0 2.795	12,0 0.472	140°	TiAIN + NbN	IT8-9
SD205A-1080-056-12R1-MS	10004276	10,8 0.425	56,0 2.205	118,0 4.646	73,0 2.874	45,0 1.772	71,0 2.795	12,0 0.472	140°	TiAIN + NbN	IT8-9
SD205A-1100-056-12R1-MS	10004277	11,0 0.433	56,0 2.205	118,0 4.646	73,0 2.874	45,0 1.772	71,0 2.795	12,0 0.472	140°	TiAIN + NbN	IT8-9
SD205A-1111-056-12R1-MS	10004278	11,11 0.437	56,0 2.205	118,0 4.646	73,0 2.874	45,0 1.772	71,0 2.795	12,0 0.472	140°	TiAIN + NbN	IT8-9
SD205A-1130-056-12R1-MS	10004279	11,3 0.445	56,0 2.205	118,0 4.646	73,0 2.874	45,0 1.772	71,0 2.795	12,0 0.472	140°	TiAIN + NbN	IT8-9
SD205A-1150-056-12R1-MS	10004280	11,5 0.453	56,0 2.205	118,0 4.646	73,0 2.874	45,0 1.772	71,0 2.795	12,0 0.472	140°	TiAIN + NbN	IT8-9
SD205A-1180-056-12R1-MS	10004281	11,8 0.465	56,0 2.205	118,0 4.646	73,0 2.874	45,0 1.772	71,0 2.795	12,0 0.472	140°	TiAIN + NbN	IT8-9
SD205A-1200-056-12R1-MS	10004282	12,0 0.472	56,0 2.205	118,0 4.646	73,0 2.874	45,0 1.772	71,0 2.795	12,0 0.472	140°	TiAIN + NbN	IT8-9
SD205A-1220-056-14R1-MS	10004283	12,2 0.480	56,0 2.205	124,0 4.882	79,0 3.110	45,0 1.772	77,0 3.031	14,0 0.551	140°	TiAIN + NbN	IT8-9
SD205A-1250-056-14R1-MS	10004284	12,5 0.492	56,0 2.205	124,0 4.882	79,0 3.110	45,0 1.772	77,0 3.031	14,0 0.551	140°	TiAIN + NbN	IT8-9
SD205A-1270-056-14R1-MS	10004285	12,7 0.500	56,0 2.205	124,0 4.882	79,0 3.110	45,0 1.772	77,0 3.031	14,0 0.551	140°	TiAIN + NbN	IT8-9
SD205A-1300-056-14R1-MS	10004286	13,0 0.512	56,0 2.205	124,0 4.882	79,0 3.110	45,0 1.772	77,0 3.031	14,0 0.551	140°	TiAIN + NbN	IT8-9

Introduzione

Foratura

Alesatura

Barenatura

Allegato

Codice di ordinazione	Codice prodotto	DC	LU	OAL	LFS	LS	LCF	DMM	Angolo di punta	Rivestimento	Tolleranza foro
		mm Inch	mm Inch	mm Inch	mm Inch	mm Inch	mm Inch	mm Inch			
SD205A-1310-056-14R1-MS	10004287	13,1 0.516	59,0 2.323	124,0 4.882	79,0 3.110	45,0 1.772	77,0 3.031	14,0 0.551	140°	TiAIN + NbN	IT8-9
SD205A-1350-059-14R1-MS	10004288	13,5 0.531	59,0 2.323	124,0 4.882	79,0 3.110	45,0 1.772	77,0 3.031	14,0 0.551	140°	TiAIN + NbN	IT8-9
SD205A-1400-059-14R1-MS	10004290	14,0 0.551	59,0 2.323	124,0 4.882	79,0 3.110	45,0 1.772	77,0 3.031	14,0 0.551	140°	TiAIN + NbN	IT8-9
SD205A-1420-060-16R1-MS	10004291	14,2 0.559	60,0 2.362	133,0 5.236	85,0 3.346	48,0 1.890	83,0 3.268	16,0 0.630	140°	TiAIN + NbN	IT8-9
SD205A-1425-060-16R1-MS	10004292	14,25 0.561	60,0 2.362	133,0 5.236	85,0 3.346	48,0 1.890	83,0 3.268	16,0 0.630	140°	TiAIN + NbN	IT8-9
SD205A-1450-060-16R1-MS	10004293	14,5 0.571	60,0 2.362	133,0 5.236	85,0 3.346	48,0 1.890	83,0 3.268	16,0 0.630	140°	TiAIN + NbN	IT8-9
SD205A-1500-060-16R1-MS	10004295	15,0 0.591	60,0 2.362	133,0 5.236	85,0 3.346	48,0 1.890	83,0 3.268	16,0 0.630	140°	TiAIN + NbN	IT8-9
SD205A-1550-062-16R1-MS	10004296	15,5 0.610	62,0 2.441	133,0 5.236	85,0 3.346	48,0 1.890	83,0 3.268	16,0 0.630	140°	TiAIN + NbN	IT8-9
SD205A-1580-062-16R1-MS	10004297	15,8 0.622	62,0 2.441	133,0 5.236	85,0 3.346	48,0 1.890	83,0 3.268	16,0 0.630	140°	TiAIN + NbN	IT8-9
SD205A-1600-062-16R1-MS	10004298	16,0 0.630	62,0 2.441	133,0 5.236	85,0 3.346	48,0 1.890	83,0 3.268	16,0 0.630	140°	TiAIN + NbN	IT8-9
SD205A-1650-071-18R1-MS	10004299	16,5 0.650	64,0 2.520	143,0 5.630	95,0 3.740	48,0 1.890	93,0 3.661	18,0 0.709	140°	TiAIN + NbN	IT8-9
SD205A-1700-071-18R1-MS	10004300	17,0 0.669	64,0 2.520	143,0 5.630	95,0 3.740	48,0 1.890	93,0 3.661	18,0 0.709	140°	TiAIN + NbN	IT8-9
SD205A-1750-071-18R1-MS	10004301	17,5 0.689	66,0 2.598	143,0 5.630	95,0 3.740	48,0 1.890	93,0 3.661	18,0 0.709	140°	TiAIN + NbN	IT8-9
SD205A-1800-071-18R1-MS	10004302	18,0 0.709	66,0 2.598	143,0 5.630	95,0 3.740	48,0 1.890	93,0 3.661	18,0 0.709	140°	TiAIN + NbN	IT8-9
SD205A-1850-077-20R1-MS	10004303	18,5 0.728	71,0 2.795	153,0 6.024	103,0 4.055	50,0 1.969	101,0 3.976	20,0 0.787	140°	TiAIN + NbN	IT8-9
SD205A-1900-077-20R1-MS	10004304	19,0 0.748	71,0 2.795	153,0 6.024	103,0 4.055	50,0 1.969	101,0 3.976	20,0 0.787	140°	TiAIN + NbN	IT8-9
SD205A-1930-077-20R1-MS	10004305	19,3 0.760	71,0 2.795	153,0 6.024	103,0 4.055	50,0 1.969	101,0 3.976	20,0 0.787	140°	TiAIN + NbN	IT8-9
SD205A-1950-077-20R1-MS	10004306	19,5 0.768	71,0 2.795	153,0 6.024	103,0 4.055	50,0 1.969	101,0 3.976	20,0 0.787	140°	TiAIN + NbN	IT8-9
SD205A-2000-077-20R1-MS	10004307	20,0 0.787	71,0 2.795	153,0 6.024	103,0 4.055	50,0 1.969	101,0 3.976	20,0 0.787	140°	TiAIN + NbN	IT8-9

Introduzione

Foratura

Alesatura

Barenatura

Allegato

SD203A, -M

Profondità di foratura ~ 3 x D – Misure metriche/Pollici

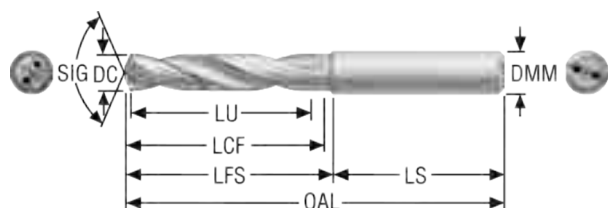

- Codolo cilindrico DIN 6537A
- Tolleranza DC m7
- Adduzione refrigerante interna
- Per i parametri di taglio raccomandati, vedere pagina(e) 161-162
- Per i diametri intermedi, utilizzare MyDesign.

Codice di ordinazione	Codice prodotto	DC	LU	OAL	LFS	LS	LCF	DMM	Angolo di punta	Rivestimento	Tolleranza foro
		mm Inch	mm Inch	mm Inch	mm Inch	mm Inch	mm Inch	mm Inch			
SD203A-3.0-14-6R1-M	02569995	3,0 0.118	14,0 0.551	62,0 2.441	26,0 1.024	36,0 1.417	20,0 0.787	6,0 0.236	140°	TiAIN + TiN	IT8-9
SD203A-3.1-14-6R1-M	02570998	3,1 0.122	14,0 0.551	62,0 2.441	26,0 1.024	36,0 1.417	20,0 0.787	6,0 0.236	140°	TiAIN + TiN	IT8-9
SD203A-3.3-14-6R1-M	02555958	3,3 0.130	14,0 0.551	62,0 2.441	26,0 1.024	36,0 1.417	20,0 0.787	6,0 0.236	140°	TiAIN + TiN	IT8-9
SD203A-3.4-14-6R1-M	02570984	3,4 0.134	14,0 0.551	62,0 2.441	26,0 1.024	36,0 1.417	20,0 0.787	6,0 0.236	140°	TiAIN + TiN	IT8-9
SD203A-3.5-15-6R1-M	02533784	3,5 0.138	15,0 0.591	62,0 2.441	26,0 1.024	36,0 1.417	20,0 0.787	6,0 0.236	140°	TiAIN + TiN	IT8-9
SD203A-3.9-17-6R1-M	02570988	3,9 0.154	17,0 0.669	66,0 2.598	30,0 1.181	36,0 1.417	24,0 0.945	6,0 0.236	140°	TiAIN + TiN	IT8-9
SD203A-4.0-17-6R1-M	02539902	4,0 0.157	17,0 0.669	66,0 2.598	30,0 1.181	36,0 1.417	24,0 0.945	6,0 0.236	140°	TiAIN + TiN	IT8-9
SD203A-4.2-17-6R1-M	02555959	4,2 0.165	17,0 0.669	66,0 2.598	30,0 1.181	36,0 1.417	24,0 0.945	6,0 0.236	140°	TiAIN + TiN	IT8-9
SD203A-4.3-18-6R1-M	02533700	4,3 0.169	18,0 0.709	66,0 2.598	30,0 1.181	36,0 1.417	24,0 0.945	6,0 0.236	140°	TiAIN + TiN	IT8-9
SD203A-4.5-18-6R1-M	02570993	4,5 0.177	18,0 0.709	66,0 2.598	30,0 1.181	36,0 1.417	24,0 0.945	6,0 0.236	140°	TiAIN + TiN	IT8-9
SD203A-01875-079-0236R1-M	02450103	4,763 0.188	20,0 0.787	66,0 2.598	30,0 1.181	36,0 1.417	28,0 1.102	6,0 0.236	140°	TiAIN + TiN	IT8-9
SD203A-4.8-20-6R1-M	02570982	4,8 0.189	20,0 0.787	66,0 2.598	30,0 1.181	36,0 1.417	28,0 1.102	6,0 0.236	140°	TiAIN + TiN	IT8-9
SD203A-4.9-20-6R1-M	02592709	4,9 0.193	20,0 0.787	66,0 2.598	30,0 1.181	36,0 1.417	28,0 1.102	6,0 0.236	140°	TiAIN + TiN	IT8-9
SD203A-5.0-20-6R1-M	02450075	5,0 0.197	20,0 0.787	66,0 2.598	30,0 1.181	36,0 1.417	28,0 1.102	6,0 0.236	140°	TiAIN + TiN	IT8-9
SD203A-5.5-21-6R1-M	02544249	5,5 0.217	20,0 0.787	66,0 2.598	30,0 1.181	36,0 1.417	28,0 1.102	6,0 0.236	140°	TiAIN + TiN	IT8-9
SD203A-02188-083-0236R1-M	02450104	5,558 0.219	20,0 0.787	66,0 2.598	30,0 1.181	36,0 1.417	28,0 1.102	6,0 0.236	140°	TiAIN + TiN	IT8-9
SD203A-5.6-21-6R1-M	02544028	5,6 0.220	21,0 0.827	66,0 2.598	30,0 1.181	36,0 1.417	28,0 1.102	6,0 0.236	140°	TiAIN + TiN	IT8-9
SD203A-5.9-21-6R1-M	02515290	5,9 0.232	21,0 0.827	66,0 2.598	30,0 1.181	36,0 1.417	28,0 1.102	6,0 0.236	140°	TiAIN + TiN	IT8-9
SD203A-6.0-21-6R1-M	02450076	6,0 0.236	21,0 0.827	66,0 2.598	30,0 1.181	36,0 1.417	28,0 1.102	6,0 0.236	140°	TiAIN + TiN	IT8-9
SD203A-02500-091-0315R1-M	02450105	6,35 0.250	23,0 0.906	79,0 3.110	43,0 1.693	36,0 1.417	34,0 1.339	8,0 0.315	140°	TiAIN + TiN	IT8-9
SD203A-6.5-23-8R1-M	02450077	6,5 0.256	23,0 0.906	79,0 3.110	43,0 1.693	36,0 1.417	34,0 1.339	8,0 0.315	140°	TiAIN + TiN	IT8-9
SD203A-6.6-23-8R1-M	02450078	6,6 0.260	23,0 0.906	79,0 3.110	43,0 1.693	36,0 1.417	34,0 1.339	8,0 0.315	140°	TiAIN + TiN	IT8-9

Codice di ordinazione	Codice prodotto	DC	LU	OAL	LFS	LS	LCF	DMM	Angolo di punta	Rivestimento	Tolleranza foro
		mm Inch	mm Inch	mm Inch	mm Inch	mm Inch	mm Inch	mm Inch			
SD203A-02656-098-0315R1-M	02450106	6,746 0.266	25,0 0.984	79,0 3.110	43,0 1.693	36,0 1.417	34,0 1.339	8,0 0.315	140°	TiAIN + TiN	IT8-9
SD203A-6.8-25-8R1-M	02450079	6,8 0.268	25,0 0.984	79,0 3.110	43,0 1.693	36,0 1.417	34,0 1.339	8,0 0.315	140°	TiAIN + TiN	IT8-9
SD203A-6.9-25-8R1-M	02450080	6,9 0.272	25,0 0.984	79,0 3.110	43,0 1.693	36,0 1.417	34,0 1.339	8,0 0.315	140°	TiAIN + TiN	IT8-9
SD203A-7.0-25-8R1-M	02450081	7,0 0.276	25,0 0.984	79,0 3.110	43,0 1.693	36,0 1.417	34,0 1.339	8,0 0.315	140°	TiAIN + TiN	IT8-9
SD203A-02813-098-0315R1-M	02450107	7,145 0.281	25,0 0.984	79,0 3.110	43,0 1.693	36,0 1.417	41,0 1.614	8,0 0.315	140°	TiAIN + TiN	IT8-9
SD203A-7.2-25-8R1-M	02537185	7,2 0.283	25,0 0.984	79,0 3.110	43,0 1.693	36,0 1.417	41,0 1.614	8,0 0.315	140°	TiAIN + TiN	IT8-9
SD203A-7.3-25-8R1-M	02530109	7,3 0.287	25,0 0.984	79,0 3.110	43,0 1.693	36,0 1.417	41,0 1.614	8,0 0.315	140°	TiAIN + TiN	IT8-9
SD203A-7.5-25-8R1-M	02450082	7,5 0.295	25,0 0.984	79,0 3.110	43,0 1.693	36,0 1.417	41,0 1.614	8,0 0.315	140°	TiAIN + TiN	IT8-9
SD203A-7.6-27-8R1-M	02545197	7,6 0.299	27,0 1.063	79,0 3.110	43,0 1.693	36,0 1.417	41,0 1.614	8,0 0.315	140°	TiAIN + TiN	IT8-9
SD203A-7.8-27-8R1-M	02450083	7,8 0.307	27,0 1.063	79,0 3.110	43,0 1.693	36,0 1.417	41,0 1.614	8,0 0.315	140°	TiAIN + TiN	IT8-9
SD203A-03125-106-0315R1-M	02450108	7,938 0.313	27,0 1.063	79,0 3.110	43,0 1.693	36,0 1.417	41,0 1.614	8,0 0.315	140°	TiAIN + TiN	IT8-9
SD203A-8.0-27-8R1-M	02450084	8,0 0.315	27,0 1.063	79,0 3.110	43,0 1.693	36,0 1.417	41,0 1.614	8,0 0.315	140°	TiAIN + TiN	IT8-9
SD203A-8.5-27-10R1-M	02450085	8,5 0.335	27,0 1.063	89,0 3.504	49,0 1.929	40,0 1.575	47,0 1.850	10,0 0.394	140°	TiAIN + TiN	IT8-9
SD203A-03438-114-0394R1-M	02450109	8,733 0.344	29,0 1.142	89,0 3.504	49,0 1.929	40,0 1.575	47,0 1.850	10,0 0.394	140°	TiAIN + TiN	IT8-9
SD203A-8.8-29-10R1-M	02450086	8,8 0.346	29,0 1.142	89,0 3.504	49,0 1.929	40,0 1.575	47,0 1.850	10,0 0.394	140°	TiAIN + TiN	IT8-9
SD203A-9.0-29-10R1-M	02450087	9,0 0.354	29,0 1.142	89,0 3.504	49,0 1.929	40,0 1.575	47,0 1.850	10,0 0.394	140°	TiAIN + TiN	IT8-9
SD203A-03594-114-0394R1-M	02450110	9,129 0.359	29,0 1.142	89,0 3.504	49,0 1.929	40,0 1.575	47,0 1.850	10,0 0.394	140°	TiAIN + TiN	IT8-9
SD203A-9.2-29-10R1-M	02546516	9,2 0.362	29,0 1.142	89,0 3.504	49,0 1.929	40,0 1.575	47,0 1.850	10,0 0.394	140°	TiAIN + TiN	IT8-9
SD203A-9.3-29-10R1-M	02582375	9,3 0.366	29,0 1.142	89,0 3.504	49,0 1.929	40,0 1.575	47,0 1.850	10,0 0.394	140°	TiAIN + TiN	IT8-9
SD203A-9.5-29-10R1-M	02450088	9,5 0.374	29,0 1.142	89,0 3.504	49,0 1.929	40,0 1.575	47,0 1.850	10,0 0.394	140°	TiAIN + TiN	IT8-9
SD203A-03750-122-0394R1-M	02450111	9,525 0.375	29,0 1.142	89,0 3.504	49,0 1.929	40,0 1.575	47,0 1.850	10,0 0.394	140°	TiAIN + TiN	IT8-9
SD203A-9.8-31-10R1-M	02450089	9,8 0.386	31,0 1.220	89,0 3.504	49,0 1.929	40,0 1.575	47,0 1.850	10,0 0.394	140°	TiAIN + TiN	IT8-9
SD203A-9.9-31-10R1-M	02515293	9,9 0.390	31,0 1.220	89,0 3.504	49,0 1.929	40,0 1.575	47,0 1.850	10,0 0.394	140°	TiAIN + TiN	IT8-9
SD203A-10.0-31-10R1-M	02450090	10,0 0.394	31,0 1.220	89,0 3.504	49,0 1.929	40,0 1.575	47,0 1.850	10,0 0.394	140°	TiAIN + TiN	IT8-9
SD203A-10.2-31-12R1-M	02450091	10,2 0.402	31,0 1.220	102,0 4.016	57,0 2.244	45,0 1.772	55,0 2.165	12,0 0.472	140°	TiAIN + TiN	IT8-9
SD203A-04063-122-0472R1-M	02450112	10,32 0.406	31,0 1.220	102,0 4.016	57,0 2.244	45,0 1.772	55,0 2.165	12,0 0.472	140°	TiAIN + TiN	IT8-9
SD203A-10.4-31-12R1-M	02535267	10,4 0.409	31,0 1.220	102,0 4.016	57,0 2.244	45,0 1.772	55,0 2.165	12,0 0.472	140°	TiAIN + TiN	IT8-9
SD203A-10.5-31-12R1-M	02450092	10,5 0.413	31,0 1.220	102,0 4.016	57,0 2.244	45,0 1.772	55,0 2.165	12,0 0.472	140°	TiAIN + TiN	IT8-9
SD203A-04219-130-0472R1-M	02450113	10,716 0.422	33,0 1.299	102,0 4.016	57,0 2.244	45,0 1.772	55,0 2.165	12,0 0.472	140°	TiAIN + TiN	IT8-9
SD203A-10.8-33-12R1-M	02450093	10,8 0.425	33,0 1.299	102,0 4.016	57,0 2.244	45,0 1.772	55,0 2.165	12,0 0.472	140°	TiAIN + TiN	IT8-9
SD203A-11.0-33-12R1-M	02450094	11,0 0.433	33,0 1.299	102,0 4.016	57,0 2.244	45,0 1.772	55,0 2.165	12,0 0.472	140°	TiAIN + TiN	IT8-9

Codice di ordinazione	Codice prodotto	DC	LU	OAL	LFS	LS	LCF	DMM	Angolo di punta	Rivestimento	Tolleranza foro
		mm <i>Inch</i>	mm <i>Inch</i>	mm <i>Inch</i>	mm <i>Inch</i>	mm <i>Inch</i>	mm <i>Inch</i>	mm <i>Inch</i>			
SD203A-04375-130-0472R1-M	02450114	11,113 <i>0.438</i>	33,0 <i>1.299</i>	102,0 <i>4.016</i>	57,0 <i>2.244</i>	45,0 <i>1.772</i>	55,0 <i>2.165</i>	12,0 <i>0.472</i>	140°	TiAIN + TiN	IT8-9
SD203A-11.5-33-12R1-M	02450095	11,5 <i>0.453</i>	33,0 <i>1.299</i>	102,0 <i>4.016</i>	57,0 <i>2.244</i>	45,0 <i>1.772</i>	55,0 <i>2.165</i>	12,0 <i>0.472</i>	140°	TiAIN + TiN	IT8-9
SD203A-11.8-33-12R1-M	02450096	11,8 <i>0.465</i>	33,0 <i>1.299</i>	102,0 <i>4.016</i>	57,0 <i>2.244</i>	45,0 <i>1.772</i>	55,0 <i>2.165</i>	12,0 <i>0.472</i>	140°	TiAIN + TiN	IT8-9
SD203A-04688-142-0472R1-M	02592711	11,908 <i>0.469</i>	36,0 <i>1.417</i>	102,0 <i>4.016</i>	57,0 <i>2.244</i>	45,0 <i>1.772</i>	55,0 <i>2.165</i>	12,0 <i>0.472</i>	140°	TiAIN + TiN	IT8-9
SD203A-12.0-36-12R1-M	02450097	12,0 <i>0.472</i>	36,0 <i>1.417</i>	102,0 <i>4.016</i>	57,0 <i>2.244</i>	45,0 <i>1.772</i>	55,0 <i>2.165</i>	12,0 <i>0.472</i>	140°	TiAIN + TiN	IT8-9
SD203A-12.25-36-14R1-M	02592712	12,25 <i>0.482</i>	36,0 <i>1.417</i>	107,0 <i>4.213</i>	62,0 <i>2.441</i>	45,0 <i>1.772</i>	60,0 <i>2.362</i>	14,0 <i>0.551</i>	140°	TiAIN + TiN	IT8-9
SD203A-12.3-36-14R1-M	02450098	12,3 <i>0.484</i>	36,0 <i>1.417</i>	107,0 <i>4.213</i>	62,0 <i>2.441</i>	45,0 <i>1.772</i>	60,0 <i>2.362</i>	14,0 <i>0.551</i>	140°	TiAIN + TiN	IT8-9
SD203A-12.5-36-14R1-M	02450099	12,5 <i>0.492</i>	36,0 <i>1.417</i>	107,0 <i>4.213</i>	62,0 <i>2.441</i>	45,0 <i>1.772</i>	60,0 <i>2.362</i>	14,0 <i>0.551</i>	140°	TiAIN + TiN	IT8-9
SD203A-05000-142-0551R1-M	02450115	12,7 <i>0.500</i>	36,0 <i>1.417</i>	107,0 <i>4.213</i>	62,0 <i>2.441</i>	45,0 <i>1.772</i>	60,0 <i>2.362</i>	14,0 <i>0.551</i>	140°	TiAIN + TiN	IT8-9
SD203A-12.9-36-14R1-M	02538263	12,9 <i>0.508</i>	36,0 <i>1.417</i>	107,0 <i>4.213</i>	62,0 <i>2.441</i>	45,0 <i>1.772</i>	60,0 <i>2.362</i>	14,0 <i>0.551</i>	140°	TiAIN + TiN	IT8-9
SD203A-13.0-36-14R1-M	02450100	13,0 <i>0.512</i>	36,0 <i>1.417</i>	107,0 <i>4.213</i>	62,0 <i>2.441</i>	45,0 <i>1.772</i>	60,0 <i>2.362</i>	14,0 <i>0.551</i>	140°	TiAIN + TiN	IT8-9
SD203A-13.5-37-14R1-M	02450101	13,5 <i>0.531</i>	37,0 <i>1.457</i>	107,0 <i>4.213</i>	62,0 <i>2.441</i>	45,0 <i>1.772</i>	60,0 <i>2.362</i>	14,0 <i>0.551</i>	140°	TiAIN + TiN	IT8-9
SD203A-14.0-37-14R1-M	02450102	14,0 <i>0.551</i>	37,0 <i>1.457</i>	107,0 <i>4.213</i>	62,0 <i>2.441</i>	45,0 <i>1.772</i>	60,0 <i>2.362</i>	14,0 <i>0.551</i>	140°	TiAIN + TiN	IT8-9
SD203A-14.25-38-16R1-M	02592715	14,25 <i>0.561</i>	38,0 <i>1.496</i>	115,0 <i>4.528</i>	67,0 <i>2.638</i>	48,0 <i>1.890</i>	65,0 <i>2.559</i>	16,0 <i>0.630</i>	140°	TiAIN + TiN	IT8-9

Introduzione

Foratura

Alesatura

Barenatura

Allegato

SD205A, -M

Profondità di foratura ~ 5 x D – Misure metriche/Pollici

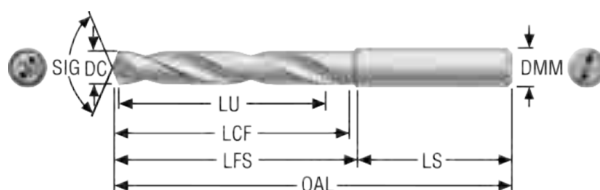

- Codolo cilindrico DIN 6537A
- Tolleranza DC m7
- Adduzione refrigerante interna
- Per i parametri di taglio raccomandati, vedere pagina(e) 163- 164
- Per i diametri intermedi, utilizzare MyDesign.

Codice di ordinazione	Codice prodotto	DC	LU	OAL	LFS	LS	LCF	DMM	Angolo di punta	Rivestimento	Tolleranza foro
		mm Inch	mm Inch	mm Inch	mm Inch	mm Inch	mm Inch	mm Inch			
SD205A-2.5-13-4R1-M	02666989	2,5 0.098	13,0 0.512	46,0 1.811	19,0 0.748	27,0 1.063	17,5 0.689	4,0 0.157	140°	TiAIN + TiN	IT8-9
SD205A-3.0-21-6R1-M	02556426	3,0 0.118	21,0 0.827	66,0 2.598	30,0 1.181	36,0 1.417	26,0 1.024	6,0 0.236	140°	TiAIN + TiN	IT8-9
SD205A-3.1-21-6R1-M	02642448	3,1 0.122	21,0 0.827	66,0 2.598	30,0 1.181	36,0 1.417	26,0 1.024	6,0 0.236	140°	TiAIN + TiN	IT8-9
SD205A-3.18-21-6R1-M	02541863	3,18 0.125	21,0 0.827	66,0 2.598	30,0 1.181	36,0 1.417	26,0 1.024	6,0 0.236	140°	TiAIN + TiN	IT8-9
SD205A-3.3-21-6R1-M	02555960	3,3 0.130	21,0 0.827	66,0 2.598	30,0 1.181	36,0 1.417	26,0 1.024	6,0 0.236	140°	TiAIN + TiN	IT8-9
SD205A-3.4-21-6R1-M	02554264	3,4 0.134	21,0 0.827	66,0 2.598	30,0 1.181	36,0 1.417	26,0 1.024	6,0 0.236	140°	TiAIN + TiN	IT8-9
SD205A-3.5-21-6R1-M	02533780	3,5 0.138	21,0 0.827	66,0 2.598	30,0 1.181	36,0 1.417	26,0 1.024	6,0 0.236	140°	TiAIN + TiN	IT8-9
SD205A-4.0-27-6R1-M	02508340	4,0 0.157	27,0 1.063	74,0 2.913	38,0 1.496	36,0 1.417	34,0 1.339	6,0 0.236	140°	TiAIN + TiN	IT8-9
SD205A-4.2-27-6R1-M	02502549	4,2 0.165	27,0 1.063	74,0 2.913	40,0 1.575	36,0 1.417	34,0 1.339	6,0 0.236	140°	TiAIN + TiN	IT8-9
SD205A-4.3-27-6R1-M	02592718	4,3 0.169	27,0 1.063	74,0 2.913	38,0 1.496	36,0 1.417	34,0 1.339	6,0 0.236	140°	TiAIN + TiN	IT8-9
SD205A-4.5-27-6R1-M	02563659	4,5 0.177	27,0 1.063	74,0 2.913	38,0 1.496	36,0 1.417	34,0 1.339	6,0 0.236	140°	TiAIN + TiN	IT8-9
SD205A-4.7-27-6R1-M	02604031	4,7 0.185	27,0 1.063	74,0 2.913	40,0 1.575	36,0 1.417	34,0 1.339	6,0 0.236	140°	TiAIN + TiN	IT8-9
SD205A-01875-126-0236R1-M	02450062	4,763 0.188	32,0 1.260	82,0 3.228	46,0 1.811	36,0 1.417	44,0 1.732	6,0 0.236	140°	TiAIN + TiN	IT8-9
SD205A-4.9-32-6R1-M	02592720	4,9 0.193	32,0 1.260	82,0 3.228	46,0 1.811	36,0 1.417	44,0 1.732	6,0 0.236	140°	TiAIN + TiN	IT8-9
SD205A-5.0-32-6R1-M	02450034	5,0 0.197	32,0 1.260	82,0 3.228	46,0 1.811	36,0 1.417	44,0 1.732	6,0 0.236	140°	TiAIN + TiN	IT8-9
SD205A-5.1-32-6R1-M	02600034	5,1 0.201	32,0 1.260	82,0 3.228	46,0 1.811	36,0 1.417	44,0 1.732	6,0 0.236	140°	TiAIN + TiN	IT8-9
SD205A-5.2-32-6R1-M	02504408	5,2 0.205	32,0 1.260	82,0 3.228	46,0 1.811	36,0 1.417	44,0 1.732	6,0 0.236	140°	TiAIN + TiN	IT8-9
SD205A-5.5-32-6R1-M	02537341	5,5 0.217	32,0 1.260	82,0 3.228	46,0 1.811	36,0 1.417	44,0 1.732	6,0 0.236	140°	TiAIN + TiN	IT8-9
SD205A-02188-126-0236R1-M	02450063	5,558 0.219	32,0 1.260	82,0 3.228	46,0 1.811	36,0 1.417	44,0 1.732	6,0 0.236	140°	TiAIN + TiN	IT8-9
SD205A-5.6-32-6R1-M	02612445	5,6 0.220	32,0 1.260	82,0 3.228	46,0 1.811	36,0 1.417	44,0 1.732	6,0 0.236	140°	TiAIN + TiN	IT8-9
SD205A-5.9-32-6R1-M	02539334	5,9 0.232	32,0 1.260	82,0 3.228	46,0 1.811	36,0 1.417	44,0 1.732	6,0 0.236	140°	TiAIN + TiN	IT8-9
SD205A-6.0-32-6R1-M	02450035	6,0 0.236	32,0 1.260	82,0 3.228	46,0 1.811	36,0 1.417	44,0 1.732	6,0 0.236	140°	TiAIN + TiN	IT8-9

Codice di ordinazione	Codice prodotto	DC	LU	OAL	LFS	LS	LCF	DMM	Angolo di punta	Rivestimento	Tolleranza foro
		mm Inch	mm Inch	mm Inch	mm Inch	mm Inch	mm Inch	mm Inch			
SD205A-6.2-35-8R1-M	02547543	6,2 0.244	35,0 1.378	91,0 3.583	55,0 2.165	36,0 1.417	53,0 2.087	8,0 0.315	140°	TiAIN + TiN	IT8-9
SD205A-02500-138-0315R1-M	02450064	6,35 0.250	35,0 1.378	91,0 3.583	55,0 2.165	36,0 1.417	53,0 2.087	8,0 0.315	140°	TiAIN + TiN	IT8-9
SD205A-6.4-35-8R1-M	02666488	6,4 0.252	35,0 1.378	91,0 3.583	55,0 2.165	36,0 1.417	53,0 2.087	8,0 0.315	140°	TiAIN + TiN	IT8-9
SD205A-6.5-35-8R1-M	02450036	6,5 0.256	35,0 1.378	91,0 3.583	55,0 2.165	36,0 1.417	53,0 2.087	8,0 0.315	140°	TiAIN + TiN	IT8-9
SD205A-6.6-35-8R1-M	02450037	6,6 0.260	35,0 1.378	91,0 3.583	55,0 2.165	36,0 1.417	53,0 2.087	8,0 0.315	140°	TiAIN + TiN	IT8-9
SD205A-6.8-40-8R1-M	02450038	6,8 0.268	40,0 1.575	91,0 3.583	55,0 2.165	36,0 1.417	53,0 2.087	8,0 0.315	140°	TiAIN + TiN	IT8-9
SD205A-6.9-40-8R1-M	02450039	6,9 0.272	40,0 1.575	91,0 3.583	55,0 2.165	36,0 1.417	53,0 2.087	8,0 0.315	140°	TiAIN + TiN	IT8-9
SD205A-02813-157-0315R1-M	02450066	7,145 0.281	40,0 1.575	91,0 3.583	55,0 2.165	36,0 1.417	53,0 2.087	8,0 0.315	140°	TiAIN + TiN	IT8-9
SD205A-7.2-40-8R1-M	02519059	7,2 0.283	40,0 1.575	91,0 3.583	55,0 2.165	36,0 1.417	53,0 2.087	8,0 0.315	140°	TiAIN + TiN	IT8-9
SD205A-7.5-40-8R1-M	02450041	7,5 0.295	40,0 1.575	91,0 3.583	55,0 2.165	36,0 1.417	53,0 2.087	8,0 0.315	140°	TiAIN + TiN	IT8-9
SD205A-7.8-42-8R1-M	02450042	7,8 0.307	42,0 1.654	91,0 3.583	55,0 2.165	36,0 1.417	53,0 2.087	8,0 0.315	140°	TiAIN + TiN	IT8-9
SD205A-03125-165-0315R1-M	02450067	7,938 0.313	42,0 1.654	91,0 3.583	55,0 2.165	36,0 1.417	53,0 2.087	8,0 0.315	140°	TiAIN + TiN	IT8-9
SD205A-8.0-42-8R1-M	02450043	8,0 0.315	42,0 1.654	91,0 3.583	55,0 2.165	36,0 1.417	53,0 2.087	8,0 0.315	140°	TiAIN + TiN	IT8-9
SD205A-8.1-42-10R1-M	02672327	8,1 0.319	42,0 1.654	103,0 4.055	63,0 2.480	40,0 1.575	61,0 2.402	10,0 0.394	140°	TiAIN + TiN	IT8-9
SD205A-8.4-42-10R1-M	02570977	8,4 0.331	42,0 1.654	103,0 4.055	63,0 2.480	40,0 1.575	61,0 2.402	10,0 0.394	140°	TiAIN + TiN	IT8-9
SD205A-8.5-42-10R1-M	02450044	8,5 0.335	42,0 1.654	103,0 4.055	63,0 2.480	40,0 1.575	61,0 2.402	10,0 0.394	140°	TiAIN + TiN	IT8-9
SD205A-8.8-45-10R1-M	02450045	8,8 0.346	45,0 1.772	103,0 4.055	63,0 2.480	40,0 1.575	61,0 2.402	10,0 0.394	140°	TiAIN + TiN	IT8-9
SD205A-9.0-45-10R1-M	02450046	9,0 0.354	45,0 1.772	103,0 4.055	63,0 2.480	40,0 1.575	61,0 2.402	10,0 0.394	140°	TiAIN + TiN	IT8-9
SD205A-9.2-45-10R1-M	02516406	9,2 0.362	45,0 1.772	103,0 4.055	63,0 2.480	40,0 1.575	61,0 2.402	10,0 0.394	140°	TiAIN + TiN	IT8-9
SD205A-9.5-45-10R1-M	02450047	9,5 0.374	45,0 1.772	103,0 4.055	63,0 2.480	40,0 1.575	61,0 2.402	10,0 0.394	140°	TiAIN + TiN	IT8-9
SD205A-03750-189-0394R1-M	02450070	9,525 0.375	48,0 1.890	103,0 4.055	63,0 2.480	40,0 1.575	61,0 2.402	10,0 0.394	140°	TiAIN + TiN	IT8-9
SD205A-9.8-48-10R1-M	02450048	9,8 0.386	48,0 1.890	103,0 4.055	63,0 2.480	40,0 1.575	61,0 2.402	10,0 0.394	140°	TiAIN + TiN	IT8-9
SD205A-10.0-48-10R1-M	02450049	10,0 0.394	48,0 1.890	103,0 4.055	63,0 2.480	40,0 1.575	61,0 2.402	10,0 0.394	140°	TiAIN + TiN	IT8-9
SD205A-10.2-48-12R1-M	02450050	10,2 0.402	48,0 1.890	118,0 4.646	73,0 2.874	45,0 1.772	71,0 2.795	12,0 0.472	140°	TiAIN + TiN	IT8-9
SD205A-10.5-48-12R1-M	02450051	10,5 0.413	48,0 1.890	118,0 4.646	73,0 2.874	45,0 1.772	71,0 2.795	12,0 0.472	140°	TiAIN + TiN	IT8-9
SD205A-10.8-56-12R1-M	02450052	10,8 0.425	56,0 2.205	118,0 4.646	73,0 2.874	45,0 1.772	71,0 2.795	12,0 0.472	140°	TiAIN + TiN	IT8-9
SD205A-10.9-56-12R1-M	02592725	10,9 0.429	56,0 2.205	118,0 4.646	73,0 2.874	45,0 1.772	71,0 2.795	12,0 0.472	140°	TiAIN + TiN	IT8-9
SD205A-11.0-56-12R1-M	02450053	11,0 0.433	56,0 2.205	118,0 4.646	73,0 2.874	45,0 1.772	71,0 2.795	12,0 0.472	140°	TiAIN + TiN	IT8-9
SD205A-04375-221-0472R1-M	02450073	11,113 0.438	56,0 2.205	118,0 4.646	73,0 2.874	45,0 1.772	71,0 2.795	12,0 0.472	140°	TiAIN + TiN	IT8-9
SD205A-11.5-56-12R1-M	02450054	11,5 0.453	56,0 2.205	118,0 4.646	73,0 2.874	45,0 1.772	71,0 2.795	12,0 0.472	140°	TiAIN + TiN	IT8-9
SD205A-11.8-56-12R1-M	02450055	11,8 0.465	56,0 2.205	118,0 4.646	73,0 2.874	45,0 1.772	71,0 2.795	12,0 0.472	140°	TiAIN + TiN	IT8-9

Introduzione

Foratura

Alesatura

Barenatura

Allegato

Codice di ordinazione	Codice prodotto	DC	LU	OAL	LFS	LS	LCF	DMM	Angolo di punta	Rivestimento	Tolleranza foro
		mm <i>Inch</i>	mm <i>Inch</i>	mm <i>Inch</i>	mm <i>Inch</i>	mm <i>Inch</i>	mm <i>Inch</i>	mm <i>Inch</i>			
SD205A-12.0-56-12R1-M	02450056	12,0 <i>0.472</i>	56,0 <i>2.205</i>	118,0 <i>4.646</i>	73,0 <i>2.874</i>	45,0 <i>1.772</i>	71,0 <i>2.795</i>	12,0 <i>0.472</i>	140°	TiAIN + TiN	IT8-9
SD205A-12.5-56-14R1-M	02450058	12,5 <i>0.492</i>	56,0 <i>2.205</i>	124,0 <i>4.882</i>	79,0 <i>3.110</i>	45,0 <i>1.772</i>	77,0 <i>3.031</i>	14,0 <i>0.551</i>	140°	TiAIN + TiN	IT8-9
SD205A-05000-221-0551R1-M	02450074	12,7 <i>0.500</i>	56,0 <i>2.205</i>	124,0 <i>4.882</i>	79,0 <i>3.110</i>	45,0 <i>1.772</i>	77,0 <i>3.031</i>	14,0 <i>0.551</i>	140°	TiAIN + TiN	IT8-9
SD205A-12.9-56-14R1-M	02592729	12,9 <i>0.508</i>	56,0 <i>2.205</i>	124,0 <i>4.882</i>	79,0 <i>3.110</i>	45,0 <i>1.772</i>	77,0 <i>3.031</i>	14,0 <i>0.551</i>	140°	TiAIN + TiN	IT8-9
SD205A-13.0-56-14R1-M	02450059	13,0 <i>0.512</i>	56,0 <i>2.205</i>	124,0 <i>4.882</i>	79,0 <i>3.110</i>	45,0 <i>1.772</i>	77,0 <i>3.031</i>	14,0 <i>0.551</i>	140°	TiAIN + TiN	IT8-9
SD205A-13.5-59-14R1-M	02450060	13,5 <i>0.531</i>	59,0 <i>2.323</i>	124,0 <i>4.882</i>	79,0 <i>3.110</i>	45,0 <i>1.772</i>	77,0 <i>3.031</i>	14,0 <i>0.551</i>	140°	TiAIN + TiN	IT8-9
SD205A-14.0-59-14R1-M	02450061	14,0 <i>0.551</i>	59,0 <i>2.323</i>	124,0 <i>4.882</i>	79,0 <i>3.110</i>	45,0 <i>1.772</i>	77,0 <i>3.031</i>	14,0 <i>0.551</i>	140°	TiAIN + TiN	IT8-9
SD205A-14.25-60-16R1-M	02592732	14,25 <i>0.561</i>	60,0 <i>2.362</i>	133,0 <i>5.236</i>	85,0 <i>3.346</i>	48,0 <i>1.890</i>	83,0 <i>3.268</i>	16,0 <i>0.630</i>	140°	TiAIN + TiN	IT8-9
SD205A-14.5-60-16R1-M	03117534	14,5 <i>0.571</i>	60,0 <i>2.362</i>	133,0 <i>5.236</i>	85,0 <i>3.346</i>	48,0 <i>1.890</i>	83,0 <i>3.268</i>	16,0 <i>0.630</i>	140°	TiAIN + TiN	IT8-9
SD205A-15.0-60-16R1-M	02570652	15,0 <i>0.591</i>	60,0 <i>2.362</i>	133,0 <i>5.236</i>	85,0 <i>3.346</i>	48,0 <i>1.890</i>	83,0 <i>3.268</i>	16,0 <i>0.630</i>	140°	TiAIN + TiN	IT8-9
SD205A-15.5-62-16R1-M	02543076	15,5 <i>0.610</i>	62,0 <i>2.441</i>	133,0 <i>5.236</i>	85,0 <i>3.346</i>	48,0 <i>1.890</i>	83,0 <i>3.268</i>	16,0 <i>0.630</i>	140°	TiAIN + TiN	IT8-9
SD205A-16.0-62-16R1-M	02555961	16,0 <i>0.630</i>	62,0 <i>2.441</i>	133,0 <i>5.236</i>	85,0 <i>3.346</i>	48,0 <i>1.890</i>	83,0 <i>3.268</i>	16,0 <i>0.630</i>	140°	TiAIN + TiN	IT8-9

Introduzione

Foratura

Alesatura

Barenatura

Allegato

SD203A, -T

Profondità di foratura ~ 3 x D – Misure metriche/Pollici

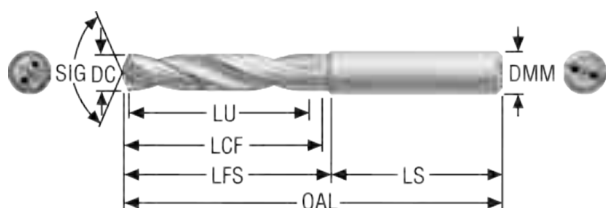

- Codolo cilindrico DIN 6537A
- Tolleranza DC m7
- Adduzione refrigerante interna
- Parametri di taglio - www.secotools.com
- Per i diametri intermedi, utilizzare MyDesign.

Codice di ordinazione	Codice prodotto	DC	LU	OAL	LFS	LS	LCF	DMM	Angolo di punta	Rivestimento	Tolleranza foro
		mm Inch	mm Inch	mm Inch	mm Inch	mm Inch	mm Inch	mm Inch			
SD203A-01875-079-0236R1-T	02569147	4,763 0.188	20,0 0.787	66,0 2.598	30,0 1.181	36,0 1.417	28,0 1.102	6,0 0.236	140°	non rivestito	IT8-9
SD203A-5.0-20-6R1-T	02523021	5,0 0.197	20,0 0.787	66,0 2.598	30,0 1.181	36,0 1.417	28,0 1.102	6,0 0.236	140°	non rivestito	IT8-9
SD203A-02188-083-0236R1-T	02569156	5,558 0.219	20,0 0.787	66,0 2.598	30,0 1.181	36,0 1.417	28,0 1.102	6,0 0.236	140°	non rivestito	IT8-9
SD203A-6.0-21-6R1-T	02542682	6,0 0.236	21,0 0.827	66,0 2.598	30,0 1.181	36,0 1.417	28,0 1.102	6,0 0.236	140°	non rivestito	IT8-9
SD203A-02500-091-0315R1-T	02569149	6,35 0.250	23,0 0.906	79,0 3.110	43,0 1.693	36,0 1.417	34,0 1.339	8,0 0.315	140°	non rivestito	IT8-9
SD203A-6.5-23-8R1-T	02545316	6,5 0.256	23,0 0.906	79,0 3.110	43,0 1.693	36,0 1.417	34,0 1.339	8,0 0.315	140°	non rivestito	IT8-9
SD203A-6.9-25-8R1-T	02537280	6,9 0.272	25,0 0.984	79,0 3.110	43,0 1.693	36,0 1.417	34,0 1.339	8,0 0.315	140°	non rivestito	IT8-9
SD203A-7.0-25-8R1-T	02525985	7,0 0.276	25,0 0.984	79,0 3.110	43,0 1.693	36,0 1.417	34,0 1.339	8,0 0.315	140°	non rivestito	IT8-9
SD203A-02813-098-0315R1-T	02569151	7,145 0.281	25,0 0.984	79,0 3.110	43,0 1.693	36,0 1.417	41,0 1.614	8,0 0.315	140°	non rivestito	IT8-9
SD203A-7.5-25-8R1-T	02527667	7,5 0.295	25,0 0.984	79,0 3.110	43,0 1.693	36,0 1.417	41,0 1.614	8,0 0.315	140°	non rivestito	IT8-9
SD203A-03125-106-0315R1-T	02569152	7,938 0.313	27,0 1.063	79,0 3.110	43,0 1.693	36,0 1.417	41,0 1.614	8,0 0.315	140°	non rivestito	IT8-9
SD203A-8.0-27-8R1-T	02513679	8,0 0.315	27,0 1.063	79,0 3.110	43,0 1.693	36,0 1.417	41,0 1.614	8,0 0.315	140°	non rivestito	IT8-9
SD203A-8.5-27-10R1-T	02548250	8,5 0.335	27,0 1.063	89,0 3.504	49,0 1.929	40,0 1.575	47,0 1.850	10,0 0.394	140°	non rivestito	IT8-9
SD203A-8.8-29-10R1-T	02569153	8,8 0.346	29,0 1.142	89,0 3.504	49,0 1.929	40,0 1.575	47,0 1.850	10,0 0.394	140°	non rivestito	IT8-9
SD203A-9.0-29-10R1-T	02524440	9,0 0.354	29,0 1.142	89,0 3.504	49,0 1.929	40,0 1.575	47,0 1.850	10,0 0.394	140°	non rivestito	IT8-9
SD203A-9.5-29-10R1-T	02545386	9,5 0.374	29,0 1.142	89,0 3.504	49,0 1.929	40,0 1.575	47,0 1.850	10,0 0.394	140°	non rivestito	IT8-9
SD203A-10.0-31-10R1-T	02525984	10,0 0.394	31,0 1.220	89,0 3.504	49,0 1.929	40,0 1.575	47,0 1.850	10,0 0.394	140°	non rivestito	IT8-9
SD203A-10.5-31-12R1-T	02545387	10,5 0.413	31,0 1.220	102,0 4.016	57,0 2.244	45,0 1.772	55,0 2.165	12,0 0.472	140°	non rivestito	IT8-9
SD203A-11.0-33-12R1-T	02569155	11,0 0.433	33,0 1.299	102,0 4.016	57,0 2.244	45,0 1.772	55,0 2.165	12,0 0.472	140°	non rivestito	IT8-9
SD203A-11.5-33-12R1-T	02567385	11,5 0.453	33,0 1.299	102,0 4.016	57,0 2.244	45,0 1.772	55,0 2.165	12,0 0.472	140°	non rivestito	IT8-9
SD203A-12.0-36-12R1-T	02562784	12,0 0.472	36,0 1.417	102,0 4.016	57,0 2.244	45,0 1.772	55,0 2.165	12,0 0.472	140°	non rivestito	IT8-9

SD205A, -T

Profondità di foratura ~ 5 x D – Misure metriche/Pollici

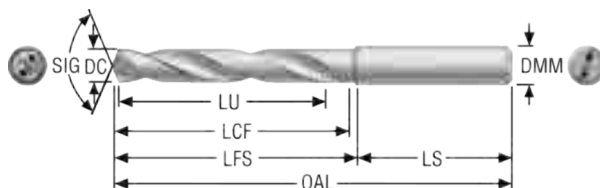

- Codolo cilindrico DIN 6537A
- Tolleranza DC m7
- Adduzione refrigerante interna
- Parametri di taglio - www.secotools.com
- Per i diametri intermedi, utilizzare MyDesign.

Codice di ordinazione	Codice prodotto	DC	LU	OAL	LFS	LS	LCF	DMM	Angolo di punta	Rivestimento	Tolleranza foro
		mm <i>Inch</i>	mm <i>Inch</i>	mm <i>Inch</i>	mm <i>Inch</i>	mm <i>Inch</i>	mm <i>Inch</i>	mm <i>Inch</i>			
SD205A-8.0-42-8R1-T	02569164	8,0 <i>0.315</i>	42,0 <i>1.654</i>	91,0 <i>3.583</i>	55,0 <i>2.165</i>	36,0 <i>1.417</i>	53,0 <i>2.087</i>	8,0 <i>0.315</i>	140°	Senza rivestimento	IT8-9
SD205A-12.0-56-12R1-T	02527621	12,0 <i>0.472</i>	56,0 <i>2.205</i>	118,0 <i>4.646</i>	73,0 <i>2.874</i>	45,0 <i>1.772</i>	71,0 <i>2.795</i>	12,0 <i>0.472</i>	140°	Senza rivestimento	IT8-9

Introduzione

Foratura

Alesatura

Barenatura

Allegato

SD203A, -N

Profondità di foratura ~ 3 x D – Misure metriche/Pollici

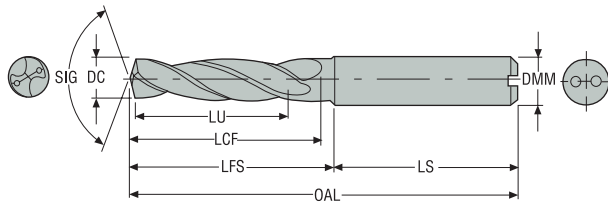

- Codolo cilindrico DIN 6537A
- Tolleranza DC m7
- Adduzione refrigerante interna
- Per i parametri di taglio raccomandati, vedere pagina(e) 145- 146
- Per i diametri intermedi, utilizzare MyDesign.

Codice di ordinazione	Codice prodotto	DC	LU	OAL	LFS	LS	LCF	DMM	Angolo di punta	Rivestimento	Tolleranza foro
		mm Inch	mm Inch	mm Inch	mm Inch	mm Inch	mm Inch	mm Inch			
SD203A-2.5-8-4R1-N	02691548	2,5 0.098	8,0 0.315	44,0 1.732	16,0 0.630	28,0 1.102	13,0 0.512	4,0 0.157	140°	Rivestimento DLC	IT8-9
SD203A-3.0-14-6R1-N	02691549	3,0 0.118	14,0 0.551	62,0 2.441	26,0 1.024	36,0 1.417	20,0 0.787	6,0 0.236	140°	Rivestimento DLC	IT8-9
SD203A-3.3-14-6R1-N	02691551	3,3 0.130	14,0 0.551	62,0 2.441	26,0 1.024	36,0 1.417	20,0 0.787	6,0 0.236	140°	Rivestimento DLC	IT8-9
SD203A-3.5-15-6R1-N	02691552	3,5 0.138	15,0 0.591	62,0 2.441	26,0 1.024	36,0 1.417	20,0 0.787	6,0 0.236	140°	Rivestimento DLC	IT8-9
SD203A-4.0-17-6R1-N	02691553	4,0 0.157	17,0 0.669	66,0 2.598	30,0 1.181	36,0 1.417	24,0 0.945	6,0 0.236	140°	Rivestimento DLC	IT8-9
SD203A-4.1-17-6R1-N	02691554	4,1 0.161	17,0 0.669	66,0 2.598	30,0 1.181	36,0 1.417	24,0 0.945	6,0 0.236	140°	Rivestimento DLC	IT8-9
SD203A-4.5-18-6R1-N	02691555	4,5 0.177	18,0 0.709	66,0 2.598	30,0 1.181	36,0 1.417	24,0 0.945	6,0 0.236	140°	Rivestimento DLC	IT8-9
SD203A-5.0-20-6R1-N	02691556	5,0 0.197	20,0 0.787	66,0 2.598	30,0 1.181	36,0 1.417	28,0 1.102	6,0 0.236	140°	Rivestimento DLC	IT8-9
SD203A-5.2-20-6R1-N	02691557	5,2 0.205	20,0 0.787	66,0 2.598	30,0 1.181	36,0 1.417	28,0 1.102	6,0 0.236	140°	Rivestimento DLC	IT8-9
SD203A-5.5-20-6R1-N	02691558	5,5 0.217	20,0 0.787	66,0 2.598	30,0 1.181	36,0 1.417	28,0 1.102	6,0 0.236	140°	Rivestimento DLC	IT8-9
SD203A-6.0-21-6R1-N	02691559	6,0 0.236	21,0 0.827	66,0 2.598	30,0 1.181	36,0 1.417	28,0 1.102	6,0 0.236	140°	Rivestimento DLC	IT8-9
SD203A-02500-091-0315R1-N	02691560	6,35 0.250	23,0 0.906	79,0 3.110	43,0 1.693	36,0 1.417	34,0 1.339	8,0 0.315	140°	Rivestimento DLC	IT8-9
SD203A-6.5-23-8R1-N	02691562	6,5 0.256	23,0 0.906	79,0 3.110	43,0 1.693	36,0 1.417	34,0 1.339	8,0 0.315	140°	Rivestimento DLC	IT8-9
SD203A-02656-098-0315R1-N	02691564	6,746 0.266	25,0 0.984	79,0 3.110	43,0 1.693	36,0 1.417	34,0 1.339	8,0 0.315	140°	Rivestimento DLC	IT8-9
SD203A-6.8-25-8R1-N	02691565	6,8 0.268	25,0 0.984	79,0 3.110	43,0 1.693	36,0 1.417	34,0 1.339	8,0 0.315	140°	Rivestimento DLC	IT8-9
SD203A-7.0-25-8R1-N	02643590	7,0 0.276	25,0 0.984	79,0 3.110	43,0 1.693	36,0 1.417	34,0 1.339	8,0 0.315	140°	Rivestimento DLC	IT8-9
SD203A-7.1-25-8R1-N	02691567	7,1 0.280	25,0 0.984	79,0 3.110	43,0 1.693	36,0 1.417	34,0 1.339	8,0 0.315	140°	Rivestimento DLC	IT8-9
SD203A-02813-098-0315R1-N	02691568	7,145 0.281	25,0 0.984	79,0 3.110	43,0 1.693	36,0 1.417	41,0 1.614	8,0 0.315	140°	Rivestimento DLC	IT8-9
SD203A-7.5-25-8R1-N	02691569	7,5 0.295	25,0 0.984	79,0 3.110	43,0 1.693	36,0 1.417	41,0 1.614	8,0 0.315	140°	Rivestimento DLC	IT8-9
SD203A-03125-106-0315R1-N	02691570	7,938 0.313	27,0 1.063	79,0 3.110	43,0 1.693	36,0 1.417	41,0 1.614	8,0 0.315	140°	Rivestimento DLC	IT8-9
SD203A-8.0-27-8R1-N	02691571	8,0 0.315	27,0 1.063	79,0 3.110	43,0 1.693	36,0 1.417	41,0 1.614	8,0 0.315	140°	Rivestimento DLC	IT8-9
SD203A-8.5-27-10R1-N	02643592	8,5 0.335	27,0 1.063	89,0 3.504	49,0 1.929	40,0 1.575	47,0 1.850	10,0 0.394	140°	Rivestimento DLC	IT8-9

Codice di ordinazione	Codice prodotto	DC	LU	OAL	LFS	LS	LCF	DMM	Angolo di punta	Rivestimento	Tolleranza foro
		mm Inch	mm Inch	mm Inch	mm Inch	mm Inch	mm Inch	mm Inch			
SD203A-9.0-29-10R1-N	02691574	9,0 0.354	29,0 1.142	89,0 3.504	49,0 1.929	40,0 1.575	47,0 1.850	10,0 0.394	140°	Rivestimento DLC	IT8-9
SD203A-9.5-29-10R1-N	02691575	9,5 0.374	29,0 1.142	89,0 3.504	49,0 1.929	40,0 1.575	47,0 1.850	10,0 0.394	140°	Rivestimento DLC	IT8-9
SD203A-03750-122-0394R1-N	02691576	9,525 0.375	31,0 1.220	89,0 3.504	49,0 1.929	40,0 1.575	47,0 1.850	10,0 0.394	140°	Rivestimento DLC	IT8-9
SD203A-10.0-31-10R1-N	02691577	10,0 0.394	31,0 1.220	89,0 3.504	49,0 1.929	40,0 1.575	47,0 1.850	10,0 0.394	140°	Rivestimento DLC	IT8-9
SD203A-10.2-31-12R1-N	02691578	10,2 0.402	31,0 1.220	102,0 4.016	57,0 2.244	45,0 1.772	55,0 2.165	12,0 0.472	140°	Rivestimento DLC	IT8-9
SD203A-04063-122-0472R1-N	02691579	10,32 0.406	31,0 1.220	102,0 4.016	57,0 2.244	45,0 1.772	55,0 2.165	12,0 0.472	140°	Rivestimento DLC	IT8-9
SD203A-10.5-31-12R1-N	02691580	10,5 0.413	31,0 1.220	102,0 4.016	57,0 2.244	45,0 1.772	55,0 2.165	12,0 0.472	140°	Rivestimento DLC	IT8-9
SD203A-11.0-33-12R1-N	02691582	11,0 0.433	33,0 1.299	102,0 4.016	57,0 2.244	45,0 1.772	55,0 2.165	12,0 0.472	140°	Rivestimento DLC	IT8-9
SD203A-04375-130-0472R1-N	02691585	11,113 0.438	33,0 1.299	102,0 4.016	57,0 2.244	45,0 1.772	55,0 2.165	12,0 0.472	140°	Rivestimento DLC	IT8-9
SD203A-11.5-33-12R1-N	02691588	11,5 0.453	33,0 1.299	102,0 4.016	57,0 2.244	45,0 1.772	55,0 2.165	12,0 0.472	140°	Rivestimento DLC	IT8-9
SD203A-12.0-36-12R1-N	02691589	12,0 0.472	36,0 1.417	102,0 4.016	57,0 2.244	45,0 1.772	55,0 2.165	12,0 0.472	140°	Rivestimento DLC	IT8-9
SD203A-12.5-36-14R1-N	02691591	12,5 0.492	36,0 1.417	107,0 4.213	62,0 2.441	45,0 1.772	60,0 2.362	14,0 0.551	140°	Rivestimento DLC	IT8-9
SD203A-05000-142-0551R1-N	02691592	12,7 0.500	36,0 1.417	107,0 4.213	62,0 2.441	45,0 1.772	60,0 2.362	14,0 0.551	140°	Rivestimento DLC	IT8-9
SD203A-13.0-36-14R1-N	02691594	13,0 0.512	36,0 1.417	107,0 4.213	62,0 2.441	45,0 1.772	60,0 2.362	14,0 0.551	140°	Rivestimento DLC	IT8-9
SD203A-05312-146-0551R1-N	02691596	13,492 0.531	37,0 1.457	107,0 4.213	62,0 2.441	45,0 1.772	60,0 2.362	14,0 0.551	140°	Rivestimento DLC	IT8-9
SD203A-13.5-37-14R1-N	02691597	13,5 0.531	37,0 1.457	107,0 4.213	62,0 2.441	45,0 1.772	60,0 2.362	14,0 0.551	140°	Rivestimento DLC	IT8-9
SD203A-14.0-37-14R1-N	02691598	14,0 0.551	37,0 1.457	107,0 4.213	62,0 2.441	45,0 1.772	60,0 2.362	14,0 0.551	140°	Rivestimento DLC	IT8-9

Introduzione

Foratura

Alesatura

Barenatura

Allegato



Foratura di compositi

Seco offre due distinte soluzioni per la foratura di materiali compositi: punte con rivestimento diamantato e punte in diamante policristallino (PCD). Questi utensili dispongono di geometrie ottimizzate in modo specifico per materiali compositi regolari o materiali stratificati.

- La geometria delle punte C1 e CX1 è ottimizzata per le lavorazioni di materiale composito CFRP
- La geometria piana delle punte C2 consente di lavorare materiali compositi stratificati in cui sono presenti strati di alluminio o titanio
- Nella lavorazione dei materiali compositi, le punte CX1 in diamante policristallino (PCD) offrono un'elevata produttività e una lunga durata dell'utensile rispetto alle punte tradizionali.
- Le punte C1 e C2 sono in metallo duro con rivestimento in diamante DURA, che fornisce un'ottima robustezza e resistenza all'abrasione

Lavorazione di materiali compositi

Introduzione

Foratura



Alesatura

Quando l'obiettivo è la qualità del foro

Sui materiali compositi e materiali sandwich, nei quali le problematiche principali sono delaminazione in entrata/uscita e scheggiature, sono state raggiunte prestazioni eccellenti. In entrambi i casi sono state raggiunte prestazioni eccellenti sia in entrata che in uscita. (Su materiali sandwich questo generalmente significa uscita su Al o Ti).

- Nessuna delaminazione in tirata (entrata)
- Nessuna delaminazione in spinta (uscita)

Il rivestimento Dura diamond assicura buona tolleranza dimensionale per tutta la vita dell'utensile.



Barenatura

Campione di applicazione

Piastra CFRP/GFRP
 (uscita su materiale composito)



Geometria C1
 Geometria CX1



Materiale sandwich
 (uscita su Al/Ti)



Geometria C2



Allegato

Problemi e soluzioni - Uscita del foro

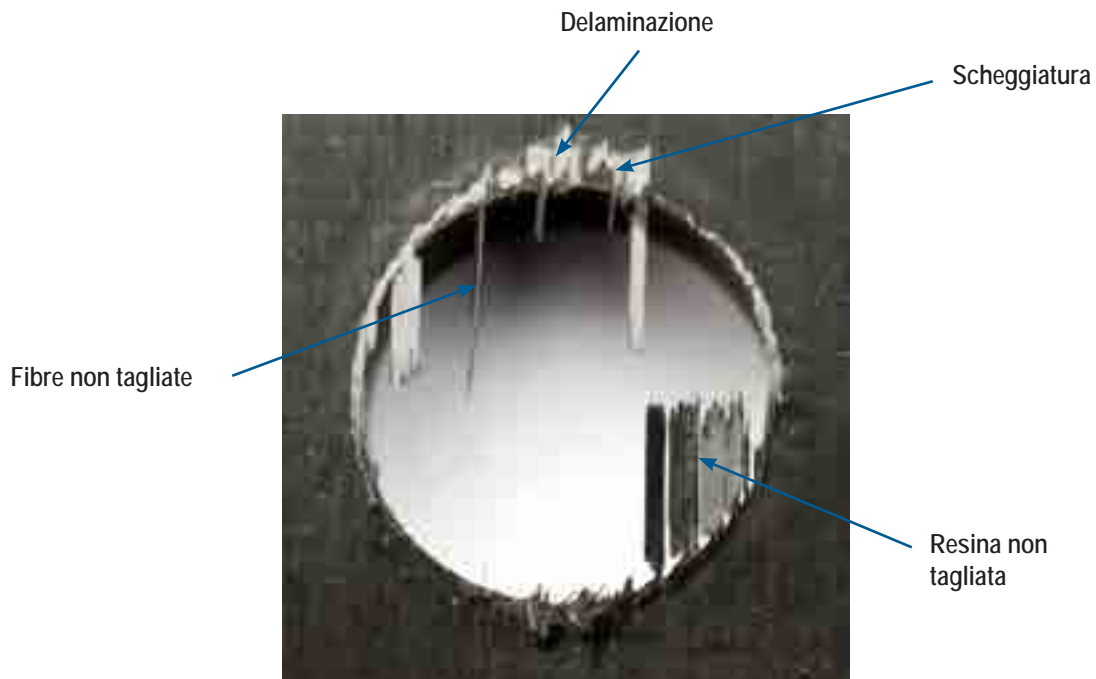

Problema:	Delaminazione (in tirata / in spinta)	Scheggiatura	Fibre non tagliate	Resina non tagliata
Soluzione:	<p>In tirata</p> <ul style="list-style-type: none"> ▪ Usare una punta con una geometria più negativa ▪ Ridurre l'avanzamento al giro <p>In spinta</p> <ul style="list-style-type: none"> ▪ Ridurre l'avanzamento al giro 	<ul style="list-style-type: none"> ▪ Usare una punta con una geometria più positiva ▪ Ridurre l'avanzamento al giro 	<ul style="list-style-type: none"> ▪ Usare una punta con una geometria più affilata ▪ Ridurre l'avanzamento al giro 	<ul style="list-style-type: none"> ▪ Usare una punta con una geometria più affilata ▪ Ridurre l'avanzamento al giro ▪ Ridurre la velocità di taglio
Problema:	Resina fusa (troppo calore)	Scarsa durata utensile		
Soluzione:	<ul style="list-style-type: none"> ▪ Ridurre la velocità di taglio 	<ul style="list-style-type: none"> ▪ Ridurre la velocità di taglio 		

SD205A-C1

Profondità di foratura ~ 5 x D – Misure metriche/Pollici

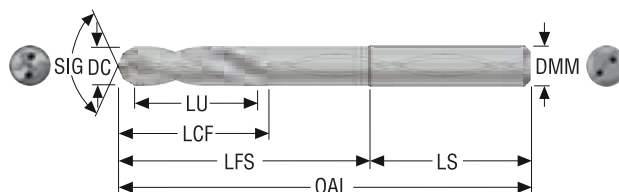

- Codolo cilindrico DIN 6537A
- Adduzione refrigerante interna
- Per i parametri di taglio raccomandati, vedere pagina(e) 165

Codice di ordinazione	Codice prodotto	Tolleranza foro attesa		DC	LU	OAL	LFS	LS	LCF	DMM	Angolo di punta	Rivestimento
		mm	Inch	mm Inch	mm Inch	mm Inch	mm Inch	mm Inch	mm Inch	mm Inch		
SD205A-6.0-31-6R1-C1	02740089	5,975/6,025	0.2352/0.2372	6,0 0.236	31,0 1.220	82,0 3.228	46,0 1.811	36,0 1.417	44,0 1.732	6,0 0.236	60°/130°	Dura Diamond
SD205A-9.55-46-10R1-C1	02740092	9,525/9,576	0.3750/0.3770	9,55 0.376	46,0 1.811	103,0 4.055	63,0 2.480	40,0 1.575	61,0 2.402	10,0 0.394	60°/130°	Dura Diamond

Introduzione

Foratura

Alesatura

Barenatura

Allegato

SD205A-C2

Profondità di foratura ~ 5 x D – Misure metriche/Pollici

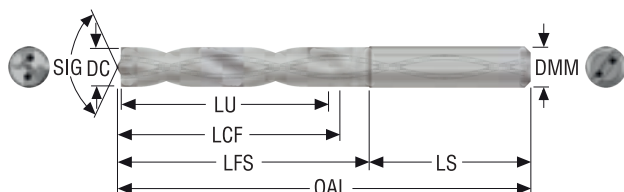

- Codolo cilindrico DIN 6537A
- Adduzione refrigerante interna
- Per i parametri di taglio raccomandati, vedere pagina(e) 165

Codice di ordinazione	Codice prodotto	Tolleranza foro attesa		DC	LU	OAL	LFS	LS	LCF	DMM	Angolo di punta	Rivestimento
		mm	Inch	mm Inch	mm Inch	mm Inch	mm Inch	mm Inch	mm Inch	mm Inch		
SD205A-6.0-32-6R1-C2	02740099	5,975/6,025	0.2352/0.2372	6,0 0.236	32,0 1.260	82,0 3.228	46,0 1.811	36,0 1.417	44,0 1.732	6,0 0.236	140°/180°	Dura Diamond
SD205A-9.55-48-10R1-C2	02740103	9,525/9,576	0.3750/0.3770	9,55 0.376	48,0 1.890	103,0 4.055	63,0 2.480	40,0 1.575	61,0 2.402	10,0 0.394	140°/180°	Dura Diamond

SD203-CX1

Profondità di foratura ~ 3 x D – Misure metriche/Pollici

Introduzione

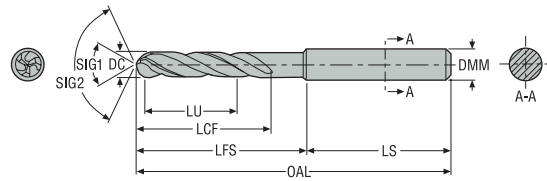

- Codolo cilindrico DIN 6537A
- Taglienti PCD
- Per i parametri di taglio raccomandati, vedere pagina(e) 165

Foratura

Codice di ordinazione	Codice prodotto	Tolleranza foro attesa		DC	LU	OAL	LFS	LS	LCF	DMM	Angolo di punta
		mm	Inch								
SD203-3.26-14-6R1-CX1	02827923	3,235/3,285	0.1273/0.1293	3,26 0.128	14,0 0.551	62,0 2.441	26,0 1.024	36,0 1.417	21,0 0.827	6,0 0.236	60°/130°
SD203-4.17-17-6R1-CX1	02827924	4,142/4,192	0.1630/0.1650	4,17 0.164	17,0 0.669	66,0 2.598	30,0 1.181	36,0 1.417	25,0 0.984	6,0 0.236	60°/130°
SD203-4.83-20-6R1-CX1	02827925	4,805/4,855	0.1891/0.1911	4,83 0.190	20,0 0.787	66,0 2.598	30,0 1.181	36,0 1.417	28,0 1.102	6,0 0.236	60°/130°
SD203-6.06-21-6R1-CX1	02827926	6,035/6,085	0.2375/0.2395	6,06 0.239	21,0 0.827	66,0 2.598	30,0 1.181	36,0 1.417	28,0 1.102	6,0 0.236	60°/130°
SD203-6.36-23-8R1-CX1	02827927	6,33/6,38	0.2492/0.2511	6,36 0.250	23,0 0.906	79,0 3.110	43,0 1.693	36,0 1.417	34,0 1.339	8,0 0.315	60°/130°
SD203-7.94-27-8R1-CX1	02827928	7,913/7,963	0.3115/0.3135	7,94 0.313	27,0 1.063	79,0 3.110	43,0 1.693	36,0 1.417	41,0 1.614	8,0 0.315	60°/130°
SD203-9.53-31-10R1-CX1	02827929	9,504/9,554	0.3741/0.3761	9,53 0.375	31,0 1.220	89,0 3.504	49,0 1.929	40,0 1.575	47,0 1.850	10,0 0.394	60°/130°

Alesatura

Barenatura

Allegato



Micro foratura

Seco dedica alle applicazioni di micro foratura una serie di prodotti specifici: le famiglie SD22 e SD26, micropunte in metallo duro integrale.

- In grado di offrire notevoli aumenti delle prestazioni rispetto alle tradizionali punte HSS
- Adatte per applicazioni nell'industria automobilistica e nell'industria medica, così come per molti altri usi nella produzione di piccoli particolari nell'industria meccanica

SD22

Profondità di foratura ~ 2 x D (punta pilota) – Misure metriche/Pollici

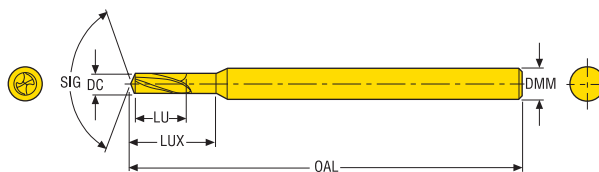

- Codolo cilindrico
- Adduzione refrigerante esterna
- Per i parametri di taglio raccomandati, vedere pagina(e) 166-170

Codice di ordinazione	Codice prodotto	DC	LU	OAL	LUX	DMM	Angolo di punta	Rivestimento
		mm Inch	mm Inch	mm Inch	mm Inch	mm Inch		
SD22-0.10-0.20-3R1	02731574	0,1 0.004	0,2 0.008	38,0 1.496	0,55 0.022	3,0 0.118	130°	Senza rivestimento
SD22-0.11-0.22-3R1	02730362	0,11 0.004	0,22 0.009	38,0 1.496	0,55 0.022	3,0 0.118	130°	Senza rivestimento
SD22-0.12-0.24-3R1	02730460	0,12 0.005	0,24 0.009	38,0 1.496	0,55 0.022	3,0 0.118	130°	Senza rivestimento
SD22-0.13-0.26-3R1	02730461	0,13 0.005	0,26 0.010	38,0 1.496	0,6 0.024	3,0 0.118	130°	Senza rivestimento
SD22-0.14-0.28-3R1	02730462	0,14 0.006	0,28 0.011	38,0 1.496	0,6 0.024	3,0 0.118	130°	Senza rivestimento
SD22-0.15-0.30-3R1	02731575	0,15 0.006	0,3 0.012	38,0 1.496	0,6 0.024	3,0 0.118	130°	Senza rivestimento
SD22-0.16-0.32-3R1	02730464	0,16 0.006	0,32 0.013	38,0 1.496	0,6 0.024	3,0 0.118	130°	Senza rivestimento
SD22-0.17-0.34-3R1	02730465	0,17 0.007	0,34 0.013	38,0 1.496	0,7 0.028	3,0 0.118	130°	Senza rivestimento
SD22-0.18-0.36-3R1	02730466	0,18 0.007	0,36 0.014	38,0 1.496	0,7 0.028	3,0 0.118	130°	Senza rivestimento
SD22-0.19-0.38-3R1	02730467	0,19 0.007	0,38 0.015	38,0 1.496	0,7 0.028	3,0 0.118	130°	Senza rivestimento
SD22-0.20-0.40-3R1	02731576	0,2 0.008	0,4 0.016	38,0 1.496	0,75 0.030	3,0 0.118	130°	Senza rivestimento
SD22-0.21-0.42-3R1	02730468	0,21 0.008	0,42 0.017	38,0 1.496	0,75 0.030	3,0 0.118	130°	Senza rivestimento
SD22-0.22-0.44-3R1	02730469	0,22 0.009	0,44 0.017	38,0 1.496	0,8 0.031	3,0 0.118	130°	Senza rivestimento
SD22-0.23-0.46-3R1	02730470	0,23 0.009	0,46 0.018	38,0 1.496	0,8 0.031	3,0 0.118	130°	Senza rivestimento
SD22-0.24-0.48-3R1	02730471	0,24 0.009	0,48 0.019	38,0 1.496	0,8 0.031	3,0 0.118	130°	Senza rivestimento
SD22-0.25-0.50-3R1	02731577	0,25 0.010	0,5 0.020	38,0 1.496	0,9 0.035	3,0 0.118	130°	Senza rivestimento
SD22-0.26-0.52-3R1	02730472	0,26 0.010	0,52 0.020	38,0 1.496	0,9 0.035	3,0 0.118	130°	Senza rivestimento
SD22-0.27-0.54-3R1	02730473	0,27 0.011	0,54 0.021	38,0 1.496	0,9 0.035	3,0 0.118	130°	Senza rivestimento
SD22-0.28-0.56-3R1	02730474	0,28 0.011	0,56 0.022	38,0 1.496	1,0 0.039	3,0 0.118	130°	Senza rivestimento
SD22-0.29-0.58-3R1	02730475	0,29 0.011	0,58 0.023	38,0 1.496	1,0 0.039	3,0 0.118	130°	Senza rivestimento
SD22-0.30-0.60-3R1	02731579	0,3 0.012	0,6 0.024	38,0 1.496	1,2 0.047	3,0 0.118	130°	Senza rivestimento
SD22-0.31-0.62-3R1	02730476	0,31 0.012	0,62 0.024	38,0 1.496	1,2 0.047	3,0 0.118	130°	Senza rivestimento

Codice di ordinazione	Codice prodotto	DC	LU	OAL	LUX	DMM	Angolo di punta	Rivestimento
		mm Inch	mm Inch	mm Inch	mm Inch	mm Inch		
SD22-0.32-0.64-3R1	02730477	0,32 0.013	0,64 0.025	38,0 1.496	1,2 0.047	3,0 0.118	130°	Senza rivestimento
SD22-0.33-0.66-3R1	02730478	0,33 0.013	0,66 0.026	38,0 1.496	1,2 0.047	3,0 0.118	130°	Senza rivestimento
SD22-0.34-0.68-3R1	02730479	0,34 0.013	0,68 0.027	38,0 1.496	1,35 0.053	3,0 0.118	130°	Senza rivestimento
SD22-0.35-0.70-3R1	02731580	0,35 0.014	0,7 0.028	38,0 1.496	1,35 0.053	3,0 0.118	130°	Senza rivestimento
SD22-0.36-0.72-3R1	02730480	0,36 0.014	0,72 0.028	38,0 1.496	1,35 0.053	3,0 0.118	130°	Senza rivestimento
SD22-0.37-0.74-3R1	02730481	0,37 0.015	0,74 0.029	38,0 1.496	1,35 0.053	3,0 0.118	130°	Senza rivestimento
SD22-0.38-0.76-3R1	02730482	0,38 0.015	0,76 0.030	38,0 1.496	1,5 0.059	3,0 0.118	130°	Senza rivestimento
SD22-0.39-0.78-3R1	02730483	0,39 0.015	0,78 0.031	38,0 1.496	1,5 0.059	3,0 0.118	130°	Senza rivestimento
SD22-0.40-0.80-3R1	02731581	0,4 0.016	0,8 0.031	38,0 1.496	1,6 0.063	3,0 0.118	130°	Senza rivestimento
SD22-0.41-0.82-3R1	02730484	0,41 0.016	0,82 0.032	38,0 1.496	1,6 0.063	3,0 0.118	130°	Senza rivestimento
SD22-0.42-0.84-3R1	02730485	0,42 0.017	0,84 0.033	38,0 1.496	1,6 0.063	3,0 0.118	130°	Senza rivestimento
SD22-0.43-0.86-3R1	02730486	0,43 0.017	0,86 0.034	38,0 1.496	1,6 0.063	3,0 0.118	130°	Senza rivestimento
SD22-0.44-0.88-3R1	02730487	0,44 0.017	0,88 0.035	38,0 1.496	1,6 0.063	3,0 0.118	130°	Senza rivestimento
SD22-0.45-0.90-3R1	02731582	0,45 0.018	0,9 0.035	38,0 1.496	1,6 0.063	3,0 0.118	130°	Senza rivestimento
SD22-0.46-0.92-3R1	02730488	0,46 0.018	0,92 0.036	38,0 1.496	1,7 0.067	3,0 0.118	130°	Senza rivestimento
SD22-0.47-0.94-3R1	02730489	0,47 0.019	0,94 0.037	38,0 1.496	1,7 0.067	3,0 0.118	130°	Senza rivestimento
SD22-0.48-0.96-3R1	02730490	0,48 0.019	0,96 0.038	38,0 1.496	1,7 0.067	3,0 0.118	130°	Senza rivestimento
SD22-0.49-0.98-3R1	02730491	0,49 0.019	0,98 0.039	38,0 1.496	1,7 0.067	3,0 0.118	130°	Senza rivestimento
SD22-0.50-1.00-3R1	02731584	0,5 0.020	1,0 0.039	38,0 1.496	1,7 0.067	3,0 0.118	130°	Senza rivestimento
SD22-0.51-1.02-3R1	02730492	0,51 0.020	1,02 0.040	38,0 1.496	1,8 0.071	3,0 0.118	130°	Senza rivestimento
SD22-0.52-1.04-3R1	02730493	0,52 0.020	1,04 0.041	38,0 1.496	1,8 0.071	3,0 0.118	130°	Senza rivestimento
SD22-0.53-1.06-3R1	02730494	0,53 0.021	1,06 0.042	38,0 1.496	1,8 0.071	3,0 0.118	130°	Senza rivestimento
SD22-0.54-1.08-3R1	02730495	0,54 0.021	1,08 0.043	38,0 1.496	1,8 0.071	3,0 0.118	130°	Senza rivestimento
SD22-0.55-1.10-3R1	02731585	0,55 0.022	1,1 0.043	38,0 1.496	1,8 0.071	3,0 0.118	130°	Senza rivestimento
SD22-0.56-1.12-3R1	02730496	0,56 0.022	1,12 0.044	38,0 1.496	1,9 0.075	3,0 0.118	130°	Senza rivestimento
SD22-0.57-1.14-3R1	02730497	0,57 0.022	1,14 0.045	38,0 1.496	1,9 0.075	3,0 0.118	130°	Senza rivestimento
SD22-0.58-1.16-3R1	02730498	0,58 0.023	1,16 0.046	38,0 1.496	1,9 0.075	3,0 0.118	130°	Senza rivestimento
SD22-0.59-1.18-3R1	02730499	0,59 0.023	1,18 0.046	38,0 1.496	1,9 0.075	3,0 0.118	130°	Senza rivestimento
SD22-0.60-1.20-3R1	02731586	0,6 0.024	1,2 0.047	38,0 1.496	1,9 0.075	3,0 0.118	130°	Senza rivestimento
SD22-0.61-1.22-3R1	02730500	0,61 0.024	1,22 0.048	38,0 1.496	2,0 0.079	3,0 0.118	130°	Senza rivestimento
SD22-0.62-1.24-3R1	02730501	0,62 0.024	1,24 0.049	38,0 1.496	2,0 0.079	3,0 0.118	130°	Senza rivestimento

Introduzione

Foratura

Alesatura

Barenatura

Allegato

Codice di ordinazione	Codice prodotto	DC	LU	OAL	LUX	DMM	Angolo di punta	Rivestimento
		mm Inch	mm Inch	mm Inch	mm Inch	mm Inch		
SD22-0.63-1.26-3R1	02730502	0,63 0.025	1,26 0.050	38,0 1.496	2,0 0.079	3,0 0.118	130°	Senza rivestimento
SD22-0.64-1.28-3R1	02730503	0,64 0.025	1,28 0.050	38,0 1.496	2,0 0.079	3,0 0.118	130°	Senza rivestimento
SD22-0.65-1.30-3R1	02731587	0,65 0.026	1,3 0.051	38,0 1.496	2,0 0.079	3,0 0.118	130°	Senza rivestimento
SD22-0.66-1.32-3R1	02730504	0,66 0.026	1,32 0.052	38,0 1.496	2,1 0.083	3,0 0.118	130°	Senza rivestimento
SD22-0.67-1.34-3R1	02730505	0,67 0.026	1,34 0.053	38,0 1.496	2,1 0.083	3,0 0.118	130°	Senza rivestimento
SD22-0.68-1.36-3R1	02730506	0,68 0.027	1,36 0.054	38,0 1.496	2,1 0.083	3,0 0.118	130°	Senza rivestimento
SD22-0.69-1.38-3R1	02730507	0,69 0.027	1,38 0.054	38,0 1.496	2,1 0.083	3,0 0.118	130°	Senza rivestimento
SD22-0.70-1.40-3R1	02731589	0,7 0.028	1,4 0.055	38,0 1.496	2,1 0.083	3,0 0.118	130°	Senza rivestimento
SD22-0.71-1.42-3R1	02730508	0,71 0.028	1,42 0.056	38,0 1.496	2,2 0.087	3,0 0.118	130°	Senza rivestimento
SD22-0.72-1.44-3R1	02730509	0,72 0.028	1,44 0.057	38,0 1.496	2,2 0.087	3,0 0.118	130°	Senza rivestimento
SD22-0.73-1.46-3R1	02730510	0,73 0.029	1,46 0.057	38,0 1.496	2,2 0.087	3,0 0.118	130°	Senza rivestimento
SD22-0.74-1.48-3R1	02730511	0,74 0.029	1,48 0.058	38,0 1.496	2,2 0.087	3,0 0.118	130°	Senza rivestimento
SD22-0.75-1.50-3R1	02731590	0,75 0.030	1,5 0.059	38,0 1.496	2,2 0.087	3,0 0.118	130°	Senza rivestimento
SD22-0.76-1.52-3R1	02730512	0,76 0.030	1,52 0.060	38,0 1.496	2,3 0.091	3,0 0.118	130°	Senza rivestimento
SD22-0.77-1.54-3R1	02730513	0,77 0.030	1,54 0.061	38,0 1.496	2,3 0.091	3,0 0.118	130°	Senza rivestimento
SD22-0.78-1.56-3R1	02730514	0,78 0.031	1,56 0.061	38,0 1.496	2,3 0.091	3,0 0.118	130°	Senza rivestimento
SD22-0.79-1.58-3R1	02730515	0,79 0.031	1,58 0.062	38,0 1.496	2,3 0.091	3,0 0.118	130°	Senza rivestimento
SD22-0.80-1.60-3R1	02731592	0,8 0.031	1,6 0.063	38,0 1.496	2,3 0.091	3,0 0.118	130°	Senza rivestimento
SD22-0.81-1.62-3R1	02730516	0,81 0.032	1,62 0.064	38,0 1.496	2,4 0.094	3,0 0.118	130°	Senza rivestimento
SD22-0.82-1.64-3R1	02730517	0,82 0.032	1,64 0.065	38,0 1.496	2,4 0.094	3,0 0.118	130°	Senza rivestimento
SD22-0.83-1.66-3R1	02730518	0,83 0.033	1,66 0.065	38,0 1.496	2,4 0.094	3,0 0.118	130°	Senza rivestimento
SD22-0.84-1.68-3R1	02730519	0,84 0.033	1,68 0.066	38,0 1.496	2,4 0.094	3,0 0.118	130°	Senza rivestimento
SD22-0.85-1.70-3R1	02731593	0,85 0.033	1,7 0.067	38,0 1.496	2,4 0.094	3,0 0.118	130°	Senza rivestimento
SD22-0.86-1.72-3R1	02730520	0,86 0.034	1,72 0.068	38,0 1.496	2,5 0.098	3,0 0.118	130°	Senza rivestimento
SD22-0.87-1.74-3R1	02730521	0,87 0.034	1,74 0.069	38,0 1.496	2,5 0.098	3,0 0.118	130°	Senza rivestimento
SD22-0.88-1.76-3R1	02730522	0,88 0.035	1,76 0.069	38,0 1.496	2,5 0.098	3,0 0.118	130°	Senza rivestimento
SD22-0.89-1.78-3R1	02730523	0,89 0.035	1,78 0.070	38,0 1.496	2,5 0.098	3,0 0.118	130°	Senza rivestimento
SD22-0.90-1.80-3R1	02731594	0,9 0.035	1,8 0.071	38,0 1.496	2,5 0.098	3,0 0.118	130°	Senza rivestimento
SD22-0.91-1.82-3R1	02730524	0,91 0.036	1,82 0.072	38,0 1.496	2,6 0.102	3,0 0.118	130°	Senza rivestimento
SD22-0.92-1.84-3R1	02730525	0,92 0.036	1,84 0.072	38,0 1.496	2,6 0.102	3,0 0.118	130°	Senza rivestimento
SD22-0.93-1.86-3R1	02730526	0,93 0.037	1,86 0.073	38,0 1.496	2,6 0.102	3,0 0.118	130°	Senza rivestimento

Codice di ordinazione	Codice prodotto	DC	LU	OAL	LUX	DMM	Angolo di punta	Rivestimento
		mm Inch	mm Inch	mm Inch	mm Inch	mm Inch		
SD22-0.94-1.88-3R1	02730527	0,94 0.037	1,88 0.074	38,0 1.496	2,6 0.102	3,0 0.118	130°	Senza rivestimento
SD22-0.95-1.90-3R1	02731595	0,95 0.037	1,9 0.075	38,0 1.496	2,6 0.102	3,0 0.118	130°	Senza rivestimento
SD22-0.96-1.92-3R1	02730528	0,96 0.038	1,92 0.076	38,0 1.496	2,7 0.106	3,0 0.118	130°	Senza rivestimento
SD22-0.97-1.94-3R1	02730529	0,97 0.038	1,94 0.076	38,0 1.496	2,7 0.106	3,0 0.118	130°	Senza rivestimento
SD22-0.98-1.96-3R1	02730530	0,98 0.039	1,96 0.077	38,0 1.496	2,7 0.106	3,0 0.118	130°	Senza rivestimento
SD22-0.99-1.98-3R1	02730531	0,99 0.039	1,98 0.078	38,0 1.496	2,7 0.106	3,0 0.118	130°	Senza rivestimento
SD22-1.00-2.00-3R1	02731596	1,0 0.039	2,0 0.079	38,0 1.496	2,7 0.106	3,0 0.118	130°	Senza rivestimento
SD22-1.01-2.02-3R1	02730532	1,01 0.040	2,02 0.080	38,0 1.496	3,5 0.138	3,0 0.118	130°	Senza rivestimento
SD22-1.02-2.04-3R1	02730533	1,02 0.040	2,04 0.080	38,0 1.496	3,5 0.138	3,0 0.118	130°	Senza rivestimento
SD22-1.03-2.06-3R1	02730534	1,03 0.041	2,06 0.081	38,0 1.496	3,5 0.138	3,0 0.118	130°	Senza rivestimento
SD22-1.04-2.08-3R1	02730535	1,04 0.041	2,08 0.082	38,0 1.496	3,5 0.138	3,0 0.118	130°	Senza rivestimento
SD22-1.05-2.10-3R1	02730536	1,05 0.041	2,1 0.083	38,0 1.496	3,5 0.138	3,0 0.118	130°	Senza rivestimento
SD22-1.06-2.12-3R1	02730537	1,06 0.042	2,12 0.083	38,0 1.496	3,6 0.142	3,0 0.118	130°	Senza rivestimento
SD22-1.07-2.14-3R1	02730538	1,07 0.042	2,14 0.084	38,0 1.496	3,6 0.142	3,0 0.118	130°	Senza rivestimento
SD22-1.08-2.16-3R1	02730539	1,08 0.043	2,16 0.085	38,0 1.496	3,6 0.142	3,0 0.118	130°	Senza rivestimento
SD22-1.09-2.18-3R1	02730540	1,09 0.043	2,18 0.086	38,0 1.496	3,6 0.142	3,0 0.118	130°	Senza rivestimento
SD22-1.10-2.20-3R1	02731598	1,1 0.043	2,2 0.087	38,0 1.496	3,6 0.142	3,0 0.118	130°	Senza rivestimento
SD22-1.11-2.22-3R1	02730541	1,11 0.044	2,22 0.087	38,0 1.496	3,7 0.146	3,0 0.118	130°	Senza rivestimento
SD22-1.12-2.24-3R1	02730542	1,12 0.044	2,24 0.088	38,0 1.496	3,7 0.146	3,0 0.118	130°	Senza rivestimento
SD22-1.13-2.26-3R1	02730543	1,13 0.044	2,26 0.089	38,0 1.496	3,7 0.146	3,0 0.118	130°	Senza rivestimento
SD22-1.14-2.28-3R1	02730544	1,14 0.045	2,28 0.090	38,0 1.496	3,7 0.146	3,0 0.118	130°	Senza rivestimento
SD22-1.15-2.30-3R1	02730545	1,15 0.045	2,3 0.091	38,0 1.496	3,7 0.146	3,0 0.118	130°	Senza rivestimento
SD22-1.16-2.32-3R1	02730546	1,16 0.046	2,32 0.091	38,0 1.496	3,8 0.150	3,0 0.118	130°	Senza rivestimento
SD22-1.17-2.34-3R1	02730547	1,17 0.046	2,34 0.092	38,0 1.496	3,8 0.150	3,0 0.118	130°	Senza rivestimento
SD22-1.18-2.36-3R1	02730548	1,18 0.046	2,36 0.093	38,0 1.496	3,8 0.150	3,0 0.118	130°	Senza rivestimento
SD22-1.19-2.38-3R1	02730549	1,19 0.047	2,38 0.094	38,0 1.496	3,8 0.150	3,0 0.118	130°	Senza rivestimento
SD22-1.20-2.40-3R1	02731599	1,2 0.047	2,4 0.094	38,0 1.496	3,8 0.150	3,0 0.118	130°	Senza rivestimento
SD22-1.21-2.42-3R1	02730550	1,21 0.048	2,42 0.095	38,0 1.496	4,2 0.165	3,0 0.118	130°	Senza rivestimento
SD22-1.22-2.44-3R1	02730551	1,22 0.048	2,44 0.096	38,0 1.496	4,2 0.165	3,0 0.118	130°	Senza rivestimento
SD22-1.23-2.46-3R1	02730552	1,23 0.048	2,46 0.097	38,0 1.496	4,2 0.165	3,0 0.118	130°	Senza rivestimento
SD22-1.24-2.48-3R1	02730553	1,24 0.049	2,48 0.098	38,0 1.496	4,2 0.165	3,0 0.118	130°	Senza rivestimento

Introduzione

Foratura

Alesatura

Barenatura

Allegato

Codice di ordinazione	Codice prodotto	DC	LU	OAL	LUX	DMM	Angolo di punta	Rivestimento	
		mm Inch	mm Inch	mm Inch	mm Inch	mm Inch			
Introduzione	SD22-1.25-2.50-3R1	02730554	1,25 0.049	2,5 0.098	38,0 1.496	4,2 0.165	3,0 0.118	130°	Senza rivestimento
	SD22-1.26-2.52-3R1	02730555	1,26 0.050	2,52 0.099	38,0 1.496	4,3 0.169	3,0 0.118	130°	Senza rivestimento
	SD22-1.27-2.54-3R1	02730556	1,27 0.050	2,54 0.100	38,0 1.496	4,3 0.169	3,0 0.118	130°	Senza rivestimento
	SD22-1.28-2.56-3R1	02730557	1,28 0.050	2,56 0.101	38,0 1.496	4,3 0.169	3,0 0.118	130°	Senza rivestimento
	SD22-1.29-2.58-3R1	02730558	1,29 0.051	2,58 0.102	38,0 1.496	4,3 0.169	3,0 0.118	130°	Senza rivestimento
Foratura	SD22-1.30-2.60-3R1	02731600	1,3 0.051	2,6 0.102	38,0 1.496	4,3 0.169	3,0 0.118	130°	Senza rivestimento
	SD22-1.31-2.62-3R1	02730559	1,31 0.052	2,62 0.103	38,0 1.496	4,4 0.173	3,0 0.118	130°	Senza rivestimento
	SD22-1.32-2.64-3R1	02730560	1,32 0.052	2,64 0.104	38,0 1.496	4,4 0.173	3,0 0.118	130°	Senza rivestimento
	SD22-1.33-2.66-3R1	02730561	1,33 0.052	2,66 0.105	38,0 1.496	4,4 0.173	3,0 0.118	130°	Senza rivestimento
	SD22-1.34-2.68-3R1	02730562	1,34 0.053	2,68 0.106	38,0 1.496	4,4 0.173	3,0 0.118	130°	Senza rivestimento
	SD22-1.35-2.70-3R1	02730563	1,35 0.053	2,7 0.106	38,0 1.496	4,4 0.173	3,0 0.118	130°	Senza rivestimento
	SD22-1.36-2.72-3R1	02730564	1,36 0.054	2,72 0.107	38,0 1.496	4,5 0.177	3,0 0.118	130°	Senza rivestimento
	SD22-1.37-2.74-3R1	02730565	1,37 0.054	2,74 0.108	38,0 1.496	4,5 0.177	3,0 0.118	130°	Senza rivestimento
	SD22-1.38-2.76-3R1	02730566	1,38 0.054	2,76 0.109	38,0 1.496	4,5 0.177	3,0 0.118	130°	Senza rivestimento
	SD22-1.39-2.78-3R1	02730567	1,39 0.055	2,78 0.109	38,0 1.496	4,5 0.177	3,0 0.118	130°	Senza rivestimento
Alesatura	SD22-1.40-2.80-3R1	02731602	1,4 0.055	2,8 0.110	38,0 1.496	4,5 0.177	3,0 0.118	130°	Senza rivestimento
	SD22-1.41-2.82-3R1	02730568	1,41 0.056	2,82 0.111	38,0 1.496	4,6 0.181	3,0 0.118	130°	Senza rivestimento
	SD22-1.42-2.84-3R1	02730569	1,42 0.056	2,84 0.112	38,0 1.496	4,6 0.181	3,0 0.118	130°	Senza rivestimento
	SD22-1.43-2.86-3R1	02730570	1,43 0.056	2,86 0.113	38,0 1.496	4,6 0.181	3,0 0.118	130°	Senza rivestimento
	SD22-1.44-2.88-3R1	02730571	1,44 0.057	2,88 0.113	38,0 1.496	4,6 0.181	3,0 0.118	130°	Senza rivestimento
	SD22-1.45-2.90-3R1	02730572	1,45 0.057	2,9 0.114	38,0 1.496	4,6 0.181	3,0 0.118	130°	Senza rivestimento
	SD22-1.46-2.92-3R1	02730573	1,46 0.057	2,92 0.115	38,0 1.496	4,7 0.185	3,0 0.118	130°	Senza rivestimento
	SD22-1.47-2.94-3R1	02730574	1,47 0.058	2,94 0.116	38,0 1.496	4,7 0.185	3,0 0.118	130°	Senza rivestimento
	SD22-1.48-2.96-3R1	02730575	1,48 0.058	2,96 0.117	38,0 1.496	4,7 0.185	3,0 0.118	130°	Senza rivestimento
	SD22-1.49-2.98-3R1	02730576	1,49 0.059	2,98 0.117	38,0 1.496	4,7 0.185	3,0 0.118	130°	Senza rivestimento
Barenatura	SD22-1.50-3.00-3R1	02731603	1,5 0.059	3,0 0.118	38,0 1.496	4,7 0.185	3,0 0.118	130°	Senza rivestimento
	SD22-1.51-3.02-3R1	02730577	1,51 0.059	3,02 0.119	38,0 1.496	5,1 0.201	3,0 0.118	130°	Senza rivestimento
	SD22-1.52-3.04-3R1	02730578	1,52 0.060	3,04 0.120	38,0 1.496	5,1 0.201	3,0 0.118	130°	Senza rivestimento
	SD22-1.53-3.06-3R1	02730579	1,53 0.060	3,06 0.120	38,0 1.496	5,1 0.201	3,0 0.118	130°	Senza rivestimento
	SD22-1.54-3.08-3R1	02730580	1,54 0.061	3,08 0.121	38,0 1.496	5,1 0.201	3,0 0.118	130°	Senza rivestimento
	SD22-1.55-3.10-3R1	02730581	1,55 0.061	3,1 0.122	38,0 1.496	5,1 0.201	3,0 0.118	130°	Senza rivestimento
Allegato									

Codice di ordinazione	Codice prodotto	DC	LU	OAL	LUX	DMM	Angolo di punta	Rivestimento
		mm Inch	mm Inch	mm Inch	mm Inch	mm Inch		
SD22-1.56-3.12-3R1	02730582	1,56 0.061	3,12 0.123	38,0 1.496	5,2 0.205	3,0 0.118	130°	Senza rivestimento
SD22-1.57-3.14-3R1	02730583	1,57 0.062	3,14 0.124	38,0 1.496	5,2 0.205	3,0 0.118	130°	Senza rivestimento
SD22-1.58-3.16-3R1	02730584	1,58 0.062	3,16 0.124	38,0 1.496	5,2 0.205	3,0 0.118	130°	Senza rivestimento
SD22-1.59-3.18-3R1	02730585	1,59 0.063	3,18 0.125	38,0 1.496	5,2 0.205	3,0 0.118	130°	Senza rivestimento
SD22-1.60-3.20-3R1	02731605	1,6 0.063	3,2 0.126	38,0 1.496	5,2 0.205	3,0 0.118	130°	Senza rivestimento
SD22-1.61-3.22-3R1	02730586	1,61 0.063	3,22 0.127	38,0 1.496	5,3 0.209	3,0 0.118	130°	Senza rivestimento
SD22-1.62-3.24-3R1	02730587	1,62 0.064	3,24 0.128	38,0 1.496	5,3 0.209	3,0 0.118	130°	Senza rivestimento
SD22-1.63-3.26-3R1	02730588	1,63 0.064	3,26 0.128	38,0 1.496	5,3 0.209	3,0 0.118	130°	Senza rivestimento
SD22-1.64-3.28-3R1	02730589	1,64 0.065	3,28 0.129	38,0 1.496	5,3 0.209	3,0 0.118	130°	Senza rivestimento
SD22-1.65-3.30-3R1	02730590	1,65 0.065	3,3 0.130	38,0 1.496	5,3 0.209	3,0 0.118	130°	Senza rivestimento
SD22-1.66-3.32-3R1	02730592	1,66 0.065	3,32 0.131	38,0 1.496	5,4 0.213	3,0 0.118	130°	Senza rivestimento
SD22-1.67-3.34-3R1	02730593	1,67 0.066	3,34 0.131	38,0 1.496	5,4 0.213	3,0 0.118	130°	Senza rivestimento
SD22-1.68-3.36-3R1	02730594	1,68 0.066	3,36 0.132	38,0 1.496	5,4 0.213	3,0 0.118	130°	Senza rivestimento
SD22-1.69-3.38-3R1	02730595	1,69 0.067	3,38 0.133	38,0 1.496	5,4 0.213	3,0 0.118	130°	Senza rivestimento
SD22-1.70-3.40-3R1	02731606	1,7 0.067	3,4 0.134	38,0 1.496	5,4 0.213	3,0 0.118	130°	Senza rivestimento
SD22-1.71-3.42-3R1	02730596	1,71 0.067	3,42 0.135	38,0 1.496	5,5 0.217	3,0 0.118	130°	Senza rivestimento
SD22-1.72-3.44-3R1	02730597	1,72 0.068	3,44 0.135	38,0 1.496	5,5 0.217	3,0 0.118	130°	Senza rivestimento
SD22-1.73-3.46-3R1	02730598	1,73 0.068	3,46 0.136	38,0 1.496	5,5 0.217	3,0 0.118	130°	Senza rivestimento
SD22-1.74-3.48-3R1	02730599	1,74 0.069	3,48 0.137	38,0 1.496	5,5 0.217	3,0 0.118	130°	Senza rivestimento
SD22-1.75-3.50-3R1	02730601	1,75 0.069	3,5 0.138	38,0 1.496	5,5 0.217	3,0 0.118	130°	Senza rivestimento
SD22-1.76-3.52-3R1	02730602	1,76 0.069	3,52 0.139	38,0 1.496	5,6 0.220	3,0 0.118	130°	Senza rivestimento
SD22-1.77-3.54-3R1	02730603	1,77 0.070	3,54 0.139	38,0 1.496	5,6 0.220	3,0 0.118	130°	Senza rivestimento
SD22-1.78-3.56-3R1	02730604	1,78 0.070	3,56 0.140	38,0 1.496	5,6 0.220	3,0 0.118	130°	Senza rivestimento
SD22-1.79-3.58-3R1	02730605	1,79 0.070	3,58 0.141	38,0 1.496	5,6 0.220	3,0 0.118	130°	Senza rivestimento
SD22-1.80-3.60-3R1	02731607	1,8 0.071	3,6 0.142	38,0 1.496	5,6 0.220	3,0 0.118	130°	Senza rivestimento
SD22-1.81-3.62-3R1	02730606	1,81 0.071	3,62 0.143	38,0 1.496	5,7 0.224	3,0 0.118	130°	Senza rivestimento
SD22-1.82-3.64-3R1	02730607	1,82 0.072	3,64 0.143	38,0 1.496	5,7 0.224	3,0 0.118	130°	Senza rivestimento
SD22-1.83-3.66-3R1	02730608	1,83 0.072	3,66 0.144	38,0 1.496	5,7 0.224	3,0 0.118	130°	Senza rivestimento
SD22-1.84-3.68-3R1	02730609	1,84 0.072	3,68 0.145	38,0 1.496	5,7 0.224	3,0 0.118	130°	Senza rivestimento
SD22-1.85-3.70-3R1	02730610	1,85 0.073	3,7 0.146	38,0 1.496	5,7 0.224	3,0 0.118	130°	Senza rivestimento
SD22-1.86-3.72-3R1	02730611	1,86 0.073	3,72 0.146	38,0 1.496	5,8 0.228	3,0 0.118	130°	Senza rivestimento

Introduzione

Foratura

Alesatura

Barenatura

Allegato

	Codice di ordinazione	Codice prodotto	DC	LU	OAL	LUX	DMM	Angolo di punta	Rivestimento
			mm Inch	mm Inch	mm Inch	mm Inch	mm Inch		
Introduzione	SD22-1.87-3.74-3R1	02730612	1,87 0.074	3,74 0.147	38,0 1.496	5,8 0.228	3,0 0.118	130°	Senza rivestimento
	SD22-1.88-3.76-3R1	02730613	1,88 0.074	3,76 0.148	38,0 1.496	5,8 0.228	3,0 0.118	130°	Senza rivestimento
	SD22-1.89-3.78-3R1	02730614	1,89 0.074	3,78 0.149	38,0 1.496	5,8 0.228	3,0 0.118	130°	Senza rivestimento
	SD22-1.90-3.80-3R1	02731609	1,9 0.075	3,8 0.150	38,0 1.496	5,8 0.228	3,0 0.118	130°	Senza rivestimento
	SD22-1.91-3.82-3R1	02730615	1,91 0.075	3,82 0.150	38,0 1.496	5,9 0.232	3,0 0.118	130°	Senza rivestimento
Foratura	SD22-1.92-3.84-3R1	02730616	1,92 0.076	3,84 0.151	38,0 1.496	5,9 0.232	3,0 0.118	130°	Senza rivestimento
	SD22-1.93-3.86-3R1	02730617	1,93 0.076	3,86 0.152	38,0 1.496	5,9 0.232	3,0 0.118	130°	Senza rivestimento
	SD22-1.94-3.88-3R1	02730618	1,94 0.076	3,88 0.153	38,0 1.496	5,9 0.232	3,0 0.118	130°	Senza rivestimento
	SD22-1.95-3.90-3R1	02730619	1,95 0.077	3,9 0.154	38,0 1.496	5,9 0.232	3,0 0.118	130°	Senza rivestimento
	SD22-1.96-3.92-3R1	02730620	1,96 0.077	3,92 0.154	38,0 1.496	6,0 0.236	3,0 0.118	130°	Senza rivestimento
	SD22-1.97-3.94-3R1	02730621	1,97 0.078	3,94 0.155	38,0 1.496	6,0 0.236	3,0 0.118	130°	Senza rivestimento
	SD22-1.98-3.96-3R1	02730622	1,98 0.078	3,96 0.156	38,0 1.496	6,0 0.236	3,0 0.118	130°	Senza rivestimento
	SD22-1.99-3.98-3R1	02730623	1,99 0.078	3,98 0.157	38,0 1.496	6,0 0.236	3,0 0.118	130°	Senza rivestimento
	SD22-2.00-4.00-3R1	02731610	2,0 0.079	4,0 0.157	38,0 1.496	6,0 0.236	3,0 0.118	130°	Senza rivestimento
	Alesatura								
Barenatura									
Allegato									

SD26

Profondità di foratura ~ 6 x D – Misure metriche/Pollici

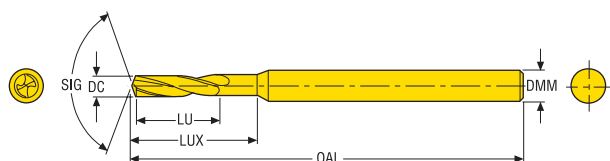

- Codolo cilindrico
- Adduzione refrigerante esterna
- Per i parametri di taglio raccomandati, vedere pagina(e) 166-170

Codice di ordinazione	Codice prodotto	DC	LU	OAL	LUX	DMM	Angolo di punta	Rivestimento
		mm Inch	mm Inch	mm Inch	mm Inch	mm Inch		
SD26-0.10-0.40-3R1	02731612	0,1 0.004	0,4 0.016	38,0 1.496	0,7 0.028	3,0 0.118	130°	Senza rivestimento
SD26-0.11-0.40-3R1	02730624	0,11 0.004	0,4 0.016	38,0 1.496	0,7 0.028	3,0 0.118	130°	Senza rivestimento
SD26-0.12-0.40-3R1	02730625	0,12 0.005	0,4 0.016	38,0 1.496	0,7 0.028	3,0 0.118	130°	Senza rivestimento
SD26-0.13-0.65-3R1	02730626	0,13 0.005	0,65 0.026	38,0 1.496	1,0 0.039	3,0 0.118	130°	Senza rivestimento
SD26-0.14-0.65-3R1	02730627	0,14 0.006	0,65 0.026	38,0 1.496	1,0 0.039	3,0 0.118	130°	Senza rivestimento
SD26-0.15-0.65-3R1	02731613	0,15 0.006	0,9 0.035	38,0 1.496	1,4 0.055	3,0 0.118	130°	Senza rivestimento
SD26-0.16-0.90-3R1	02730628	0,16 0.006	0,9 0.035	38,0 1.496	1,4 0.055	3,0 0.118	130°	Senza rivestimento
SD26-0.17-0.90-3R1	02730629	0,17 0.007	0,9 0.035	38,0 1.496	1,4 0.055	3,0 0.118	130°	Senza rivestimento
SD26-0.18-0.90-3R1	02730630	0,18 0.007	0,9 0.035	38,0 1.496	1,4 0.055	3,0 0.118	130°	Senza rivestimento
SD26-0.19-0.90-3R1	02730631	0,19 0.007	0,9 0.035	38,0 1.496	1,4 0.055	3,0 0.118	130°	Senza rivestimento
SD26-0.20-1.25-3R1	02731615	0,2 0.008	1,25 0.049	38,0 1.496	1,8 0.071	3,0 0.118	130°	Senza rivestimento
SD26-0.21-1.25-3R1	02730632	0,21 0.008	1,25 0.049	38,0 1.496	1,8 0.071	3,0 0.118	130°	Senza rivestimento
SD26-0.22-1.25-3R1	02730633	0,22 0.009	1,25 0.049	38,0 1.496	1,8 0.071	3,0 0.118	130°	Senza rivestimento
SD26-0.23-1.25-3R1	02730634	0,23 0.009	1,25 0.049	38,0 1.496	1,8 0.071	3,0 0.118	130°	Senza rivestimento
SD26-0.24-1.25-3R1	02730635	0,24 0.009	1,25 0.049	38,0 1.496	1,8 0.071	3,0 0.118	130°	Senza rivestimento
SD26-0.25-1.55-3R1	02731617	0,25 0.010	1,55 0.061	38,0 1.496	2,2 0.087	3,0 0.118	130°	Senza rivestimento
SD26-0.26-1.55-3R1	02730636	0,26 0.010	1,55 0.061	38,0 1.496	2,2 0.087	3,0 0.118	130°	Senza rivestimento
SD26-0.27-1.55-3R1	02730637	0,27 0.011	1,55 0.061	38,0 1.496	2,2 0.087	3,0 0.118	130°	Senza rivestimento
SD26-0.28-1.55-3R1	02730638	0,28 0.011	1,55 0.061	38,0 1.496	2,2 0.087	3,0 0.118	130°	Senza rivestimento
SD26-0.29-1.55-3R1	02730639	0,29 0.011	1,55 0.061	38,0 1.496	2,2 0.087	3,0 0.118	130°	Senza rivestimento
SD26-0.30-1.80-3R1	02731618	0,3 0.012	1,8 0.071	38,0 1.496	2,4 0.094	3,0 0.118	130°	Senza rivestimento
SD26-0.31-1.80-3R1	02730640	0,31 0.012	1,8 0.071	38,0 1.496	2,4 0.094	3,0 0.118	130°	Senza rivestimento

Codice di ordinazione	Codice prodotto	DC	LU	OAL	LUX	DMM	Angolo di punta	Rivestimento	
		mm Inch	mm Inch	mm Inch	mm Inch	mm Inch			
Introduzione	SD26-0.32-1.80-3R1	0,32 0.013	1,8 0.071	38,0 1.496	2,4 0.094	3,0 0.118	130°	Senza rivestimento	
	SD26-0.33-1.80-3R1	0,33 0.013	1,8 0.071	38,0 1.496	2,4 0.094	3,0 0.118	130°	Senza rivestimento	
	SD26-0.34-1.80-3R1	0,34 0.013	1,8 0.071	38,0 1.496	2,4 0.094	3,0 0.118	130°	Senza rivestimento	
	SD26-0.35-2.20-3R1	0,35 0.014	2,2 0.087	38,0 1.496	2,8 0.110	3,0 0.118	130°	Senza rivestimento	
	SD26-0.36-2.20-3R1	0,36 0.014	2,2 0.087	38,0 1.496	2,8 0.110	3,0 0.118	130°	Senza rivestimento	
Foratura	SD26-0.37-2.20-3R1	0,37 0.015	2,2 0.087	38,0 1.496	2,8 0.110	3,0 0.118	130°	Senza rivestimento	
	SD26-0.38-2.20-3R1	0,38 0.015	2,2 0.087	38,0 1.496	2,8 0.110	3,0 0.118	130°	Senza rivestimento	
	SD26-0.39-2.70-3R1	0,39 0.015	2,7 0.106	38,0 1.496	3,6 0.142	3,0 0.118	130°	Senza rivestimento	
	SD26-0.40-2.70-3R1	0,4 0.016	2,7 0.106	38,0 1.496	3,6 0.142	3,0 0.118	130°	Senza rivestimento	
	SD26-0.41-2.70-3R1	0,41 0.016	2,7 0.106	38,0 1.496	3,6 0.142	3,0 0.118	130°	Senza rivestimento	
	SD26-0.42-2.70-3R1	0,42 0.017	2,7 0.106	38,0 1.496	3,6 0.142	3,0 0.118	130°	Senza rivestimento	
	SD26-0.43-2.70-3R1	0,43 0.017	2,7 0.106	38,0 1.496	3,6 0.142	3,0 0.118	130°	Senza rivestimento	
	SD26-0.44-2.70-3R1	0,44 0.017	2,7 0.106	38,0 1.496	3,6 0.142	3,0 0.118	130°	Senza rivestimento	
	SD26-0.45-2.70-3R1	0,45 0.018	2,7 0.106	38,0 1.496	3,6 0.142	3,0 0.118	130°	Senza rivestimento	
	SD26-0.46-2.70-3R1	0,46 0.018	2,7 0.106	38,0 1.496	3,6 0.142	3,0 0.118	130°	Senza rivestimento	
Alesatura	SD26-0.47-2.70-3R1	0,47 0.019	2,7 0.106	38,0 1.496	3,6 0.142	3,0 0.118	130°	Senza rivestimento	
	SD26-0.48-2.70-3R1	0,48 0.019	2,7 0.106	38,0 1.496	3,6 0.142	3,0 0.118	130°	Senza rivestimento	
	SD26-0.49-3.20-3R1	0,49 0.019	3,2 0.126	38,0 1.496	4,0 0.157	3,0 0.118	130°	Senza rivestimento	
	SD26-0.50-3.20-3R1	0,5 0.020	3,2 0.126	38,0 1.496	4,0 0.157	3,0 0.118	130°	Senza rivestimento	
	SD26-0.51-3.20-3R1	0,51 0.020	3,2 0.126	38,0 1.496	4,0 0.157	3,0 0.118	130°	Senza rivestimento	
	SD26-0.52-3.20-3R1	0,52 0.020	3,2 0.126	38,0 1.496	4,0 0.157	3,0 0.118	130°	Senza rivestimento	
	SD26-0.53-3.20-3R1	0,53 0.021	3,2 0.126	38,0 1.496	4,0 0.157	3,0 0.118	130°	Senza rivestimento	
	SD26-0.54-3.60-3R1	0,54 0.021	3,6 0.142	38,0 1.496	4,5 0.177	3,0 0.118	130°	Senza rivestimento	
	SD26-0.55-3.60-3R1	0,55 0.022	3,6 0.142	38,0 1.496	4,5 0.177	3,0 0.118	130°	Senza rivestimento	
	SD26-0.56-3.60-3R1	0,56 0.022	3,6 0.142	38,0 1.496	4,5 0.177	3,0 0.118	130°	Senza rivestimento	
Barenatura	SD26-0.57-3.60-3R1	0,57 0.022	3,6 0.142	38,0 1.496	4,5 0.177	3,0 0.118	130°	Senza rivestimento	
	SD26-0.58-3.60-3R1	0,58 0.023	3,6 0.142	38,0 1.496	4,5 0.177	3,0 0.118	130°	Senza rivestimento	
	SD26-0.59-3.60-3R1	0,59 0.023	3,6 0.142	38,0 1.496	4,5 0.177	3,0 0.118	130°	Senza rivestimento	
	SD26-0.60-3.60-3R1	0,6 0.024	3,6 0.142	38,0 1.496	4,5 0.177	3,0 0.118	130°	Senza rivestimento	
	SD26-0.61-3.90-3R1	0,61 0.024	3,6 0.142	38,0 1.496	4,5 0.177	3,0 0.118	130°	Senza rivestimento	
	SD26-0.62-3.90-3R1	0,62 0.024	3,9 0.154	38,0 1.496	5,0 0.197	3,0 0.118	130°	Senza rivestimento	
	Allegato								

Codice di ordinazione	Codice prodotto	DC	LU	OAL	LUX	DMM	Angolo di punta	Rivestimento
		mm Inch	mm Inch	mm Inch	mm Inch	mm Inch		
SD26-0.63-3.90-3R1	02730666	0,63 0.025	3,9 0.154	38,0 1.496	5,0 0.197	3,0 0.118	130°	Senza rivestimento
SD26-0.64-3.90-3R1	02730667	0,64 0.025	3,9 0.154	38,0 1.496	5,0 0.197	3,0 0.118	130°	Senza rivestimento
SD26-0.65-3.90-3R1	02731625	0,65 0.026	3,9 0.154	38,0 1.496	5,0 0.197	3,0 0.118	130°	Senza rivestimento
SD26-0.66-3.90-3R1	02730668	0,66 0.026	3,9 0.154	38,0 1.496	5,0 0.197	3,0 0.118	130°	Senza rivestimento
SD26-0.67-3.90-3R1	02730669	0,67 0.026	3,9 0.154	38,0 1.496	5,0 0.197	3,0 0.118	130°	Senza rivestimento
SD26-0.68-4.50-3R1	02730670	0,68 0.027	4,5 0.177	38,0 1.496	5,6 0.220	3,0 0.118	130°	Senza rivestimento
SD26-0.69-4.50-3R1	02730671	0,69 0.027	4,5 0.177	38,0 1.496	5,6 0.220	3,0 0.118	130°	Senza rivestimento
SD26-0.70-4.50-3R1	02731626	0,7 0.028	4,5 0.177	38,0 1.496	5,6 0.220	3,0 0.118	130°	Senza rivestimento
SD26-0.71-4.50-3R1	02730672	0,71 0.028	4,5 0.177	38,0 1.496	5,6 0.220	3,0 0.118	130°	Senza rivestimento
SD26-0.72-4.50-3R1	02730673	0,72 0.028	4,5 0.177	38,0 1.496	5,6 0.220	3,0 0.118	130°	Senza rivestimento
SD26-0.73-4.50-3R1	02730674	0,73 0.029	4,5 0.177	38,0 1.496	5,6 0.220	3,0 0.118	130°	Senza rivestimento
SD26-0.74-4.50-3R1	02730675	0,74 0.029	4,5 0.177	38,0 1.496	5,6 0.220	3,0 0.118	130°	Senza rivestimento
SD26-0.75-4.50-3R1	02731627	0,75 0.030	4,5 0.177	38,0 1.496	5,6 0.220	3,0 0.118	130°	Senza rivestimento
SD26-0.76-5.00-3R1	02730676	0,76 0.030	5,0 0.197	38,0 1.496	6,3 0.248	3,0 0.118	130°	Senza rivestimento
SD26-0.77-5.00-3R1	02730677	0,77 0.030	5,0 0.197	38,0 1.496	6,3 0.248	3,0 0.118	130°	Senza rivestimento
SD26-0.78-5.00-3R1	02730678	0,78 0.031	5,0 0.197	38,0 1.496	6,3 0.248	3,0 0.118	130°	Senza rivestimento
SD26-0.79-5.00-3R1	02730679	0,79 0.031	5,0 0.197	38,0 1.496	6,3 0.248	3,0 0.118	130°	Senza rivestimento
SD26-0.80-5.00-3R1	02731628	0,8 0.031	5,0 0.197	38,0 1.496	6,3 0.248	3,0 0.118	130°	Senza rivestimento
SD26-0.81-5.00-3R1	02730680	0,81 0.032	5,0 0.197	38,0 1.496	6,3 0.248	3,0 0.118	130°	Senza rivestimento
SD26-0.82-5.00-3R1	02730681	0,82 0.032	5,0 0.197	38,0 1.496	6,3 0.248	3,0 0.118	130°	Senza rivestimento
SD26-0.83-5.00-3R1	02730682	0,83 0.033	5,0 0.197	38,0 1.496	6,3 0.248	3,0 0.118	130°	Senza rivestimento
SD26-0.84-5.00-3R1	02730683	0,84 0.033	5,0 0.197	38,0 1.496	6,3 0.248	3,0 0.118	130°	Senza rivestimento
SD26-0.85-5.00-3R1	02731629	0,85 0.033	5,0 0.197	38,0 1.496	6,3 0.248	3,0 0.118	130°	Senza rivestimento
SD26-0.86-5.70-3R1	02730684	0,86 0.034	5,7 0.224	38,0 1.496	7,1 0.280	3,0 0.118	130°	Senza rivestimento
SD26-0.87-5.70-3R1	02730685	0,87 0.034	5,7 0.224	38,0 1.496	7,1 0.280	3,0 0.118	130°	Senza rivestimento
SD26-0.88-5.70-3R1	02730686	0,88 0.035	5,7 0.224	38,0 1.496	7,1 0.280	3,0 0.118	130°	Senza rivestimento
SD26-0.89-5.70-3R1	02730687	0,89 0.035	5,7 0.224	38,0 1.496	7,1 0.280	3,0 0.118	130°	Senza rivestimento
SD26-0.90-5.70-3R1	02731630	0,9 0.035	5,7 0.224	38,0 1.496	7,1 0.280	3,0 0.118	130°	Senza rivestimento
SD26-0.91-5.70-3R1	02730688	0,91 0.036	5,7 0.224	38,0 1.496	7,1 0.280	3,0 0.118	130°	Senza rivestimento
SD26-0.92-5.70-3R1	02730689	0,92 0.036	5,7 0.224	38,0 1.496	7,1 0.280	3,0 0.118	130°	Senza rivestimento
SD26-0.93-5.70-3R1	02730690	0,93 0.037	5,7 0.224	38,0 1.496	7,1 0.280	3,0 0.118	130°	Senza rivestimento

Introduzione

Foratura

Alesatura

Barenatura

Allegato

Codice di ordinazione	Codice prodotto	DC	LU	OAL	LUX	DMM	Angolo di punta	Rivestimento
		mm Inch	mm Inch	mm Inch	mm Inch	mm Inch		
SD26-0.94-5.70-3R1	02730691	0,94 0.037	5,7 0.224	38,0 1.496	7,1 0.280	3,0 0.118	130°	Senza rivestimento
SD26-0.95-5.70-3R1	02731631	0,95 0.037	5,7 0.224	38,0 1.496	7,1 0.280	3,0 0.118	130°	Senza rivestimento
SD26-0.96-6.50-3R1	02730692	0,96 0.038	6,5 0.256	38,0 1.496	8,0 0.315	3,0 0.118	130°	Senza rivestimento
SD26-0.97-6.50-3R1	02730693	0,97 0.038	6,5 0.256	38,0 1.496	8,0 0.315	3,0 0.118	130°	Senza rivestimento
SD26-0.98-6.50-3R1	02730694	0,98 0.039	6,5 0.256	38,0 1.496	8,0 0.315	3,0 0.118	130°	Senza rivestimento
SD26-0.99-6.50-3R1	02730695	0,99 0.039	6,5 0.256	38,0 1.496	8,0 0.315	3,0 0.118	130°	Senza rivestimento
SD26-1.00-6.50-3R1	02731632	1,0 0.039	6,5 0.256	38,0 1.496	8,0 0.315	3,0 0.118	130°	Senza rivestimento
SD26-1.01-6.50-3R1	02730696	1,01 0.040	6,5 0.256	38,0 1.496	8,0 0.315	3,0 0.118	130°	Senza rivestimento
SD26-1.02-6.50-3R1	02730697	1,02 0.040	6,5 0.256	38,0 1.496	8,0 0.315	3,0 0.118	130°	Senza rivestimento
SD26-1.03-6.50-3R1	02730698	1,03 0.041	6,5 0.256	38,0 1.496	8,0 0.315	3,0 0.118	130°	Senza rivestimento
SD26-1.04-6.50-3R1	02730699	1,04 0.041	6,5 0.256	38,0 1.496	8,0 0.315	3,0 0.118	130°	Senza rivestimento
SD26-1.05-6.50-3R1	02730700	1,05 0.041	6,5 0.256	38,0 1.496	8,0 0.315	3,0 0.118	130°	Senza rivestimento
SD26-1.06-7.30-3R1	02730701	1,06 0.042	7,3 0.287	38,0 1.496	9,0 0.354	3,0 0.118	130°	Senza rivestimento
SD26-1.07-7.30-3R1	02730702	1,07 0.042	7,3 0.287	38,0 1.496	9,0 0.354	3,0 0.118	130°	Senza rivestimento
SD26-1.08-7.30-3R1	02730703	1,08 0.043	7,3 0.287	38,0 1.496	9,0 0.354	3,0 0.118	130°	Senza rivestimento
SD26-1.09-7.30-3R1	02730704	1,09 0.043	7,3 0.287	38,0 1.496	9,0 0.354	3,0 0.118	130°	Senza rivestimento
SD26-1.10-7.30-3R1	02731633	1,1 0.043	7,3 0.287	38,0 1.496	9,0 0.354	3,0 0.118	130°	Senza rivestimento
SD26-1.11-7.30-3R1	02730705	1,11 0.044	7,3 0.287	38,0 1.496	9,0 0.354	3,0 0.118	130°	Senza rivestimento
SD26-1.12-7.30-3R1	02730706	1,12 0.044	7,3 0.287	38,0 1.496	9,0 0.354	3,0 0.118	130°	Senza rivestimento
SD26-1.13-7.30-3R1	02730707	1,13 0.044	7,3 0.287	38,0 1.496	9,0 0.354	3,0 0.118	130°	Senza rivestimento
SD26-1.14-7.30-3R1	02730708	1,14 0.045	7,3 0.287	38,0 1.496	9,0 0.354	3,0 0.118	130°	Senza rivestimento
SD26-1.15-7.30-3R1	02730709	1,15 0.045	7,3 0.287	38,0 1.496	9,0 0.354	3,0 0.118	130°	Senza rivestimento
SD26-1.16-8.20-3R1	02730710	1,16 0.046	8,2 0.323	38,0 1.496	10,0 0.394	3,0 0.118	130°	Senza rivestimento
SD26-1.17-8.20-3R1	02730711	1,17 0.046	8,2 0.323	38,0 1.496	10,0 0.394	3,0 0.118	130°	Senza rivestimento
SD26-1.18-8.20-3R1	02730712	1,18 0.046	8,2 0.323	38,0 1.496	10,0 0.394	3,0 0.118	130°	Senza rivestimento
SD26-1.19-8.20-3R1	02730713	1,19 0.047	8,2 0.323	38,0 1.496	10,0 0.394	3,0 0.118	130°	Senza rivestimento
SD26-1.20-8.20-3R1	02731634	1,2 0.047	8,2 0.323	38,0 1.496	10,0 0.394	3,0 0.118	130°	Senza rivestimento
SD26-1.21-8.20-3R1	02730714	1,21 0.048	8,2 0.323	38,0 1.496	10,0 0.394	3,0 0.118	130°	Senza rivestimento
SD26-1.22-8.20-3R1	02730715	1,22 0.048	8,2 0.323	38,0 1.496	10,0 0.394	3,0 0.118	130°	Senza rivestimento
SD26-1.23-8.20-3R1	02730716	1,23 0.048	8,2 0.323	38,0 1.496	10,0 0.394	3,0 0.118	130°	Senza rivestimento
SD26-1.24-8.20-3R1	02730717	1,24 0.049	8,2 0.323	38,0 1.496	10,0 0.394	3,0 0.118	130°	Senza rivestimento

Codice di ordinazione	Codice prodotto	DC	LU	OAL	LUX	DMM	Angolo di punta	Rivestimento
		mm Inch	mm Inch	mm Inch	mm Inch	mm Inch		
SD26-1.25-8.20-3R1	02730718	1,25 0.049	8,2 0.323	38,0 1.496	10,0 0.394	3,0 0.118	130°	Senza rivestimento
SD26-1.26-8.20-3R1	02730719	1,26 0.050	8,2 0.323	38,0 1.496	10,0 0.394	3,0 0.118	130°	Senza rivestimento
SD26-1.27-8.20-3R1	02730720	1,27 0.050	8,2 0.323	38,0 1.496	10,0 0.394	3,0 0.118	130°	Senza rivestimento
SD26-1.28-8.20-3R1	02730721	1,28 0.050	8,2 0.323	38,0 1.496	10,0 0.394	3,0 0.118	130°	Senza rivestimento
SD26-1.29-8.20-3R1	02730722	1,29 0.051	8,2 0.323	38,0 1.496	10,0 0.394	3,0 0.118	130°	Senza rivestimento
SD26-1.30-8.20-3R1	02731635	1,3 0.051	8,2 0.323	38,0 1.496	10,0 0.394	3,0 0.118	130°	Senza rivestimento
SD26-1.31-9.20-3R1	02730723	1,31 0.052	9,2 0.362	38,0 1.496	11,2 0.441	3,0 0.118	130°	Senza rivestimento
SD26-1.32-9.20-3R1	02730724	1,32 0.052	9,2 0.362	38,0 1.496	11,2 0.441	3,0 0.118	130°	Senza rivestimento
SD26-1.33-9.20-3R1	02730725	1,33 0.052	9,2 0.362	38,0 1.496	11,2 0.441	3,0 0.118	130°	Senza rivestimento
SD26-1.34-9.20-3R1	02730726	1,34 0.053	9,2 0.362	38,0 1.496	11,2 0.441	3,0 0.118	130°	Senza rivestimento
SD26-1.35-9.20-3R1	02730727	1,35 0.053	9,2 0.362	38,0 1.496	11,2 0.441	3,0 0.118	130°	Senza rivestimento
SD26-1.36-9.20-3R1	02730728	1,36 0.054	9,2 0.362	38,0 1.496	11,2 0.441	3,0 0.118	130°	Senza rivestimento
SD26-1.37-9.20-3R1	02730729	1,37 0.054	9,2 0.362	38,0 1.496	11,2 0.441	3,0 0.118	130°	Senza rivestimento
SD26-1.38-9.20-3R1	02730730	1,38 0.054	9,2 0.362	38,0 1.496	11,2 0.441	3,0 0.118	130°	Senza rivestimento
SD26-1.39-9.20-3R1	02730731	1,39 0.055	9,2 0.362	38,0 1.496	11,2 0.441	3,0 0.118	130°	Senza rivestimento
SD26-1.40-9.20-3R1	02731637	1,4 0.055	9,2 0.362	38,0 1.496	11,2 0.441	3,0 0.118	130°	Senza rivestimento
SD26-1.41-9.20-3R1	02730732	1,41 0.056	9,2 0.362	38,0 1.496	11,2 0.441	3,0 0.118	130°	Senza rivestimento
SD26-1.42-9.20-3R1	02730733	1,42 0.056	9,2 0.362	38,0 1.496	11,2 0.441	3,0 0.118	130°	Senza rivestimento
SD26-1.43-9.20-3R1	02730734	1,43 0.056	9,2 0.362	38,0 1.496	11,2 0.441	3,0 0.118	130°	Senza rivestimento
SD26-1.44-9.20-3R1	02730735	1,44 0.057	9,2 0.362	38,0 1.496	11,2 0.441	3,0 0.118	130°	Senza rivestimento
SD26-1.45-9.20-3R1	02730736	1,45 0.057	9,2 0.362	38,0 1.496	11,2 0.441	3,0 0.118	130°	Senza rivestimento
SD26-1.46-9.20-3R1	02730737	1,46 0.057	9,2 0.362	38,0 1.496	11,2 0.441	3,0 0.118	130°	Senza rivestimento
SD26-1.47-9.20-3R1	02730738	1,47 0.058	9,2 0.362	38,0 1.496	11,2 0.441	3,0 0.118	130°	Senza rivestimento
SD26-1.48-9.20-3R1	02730739	1,48 0.058	9,2 0.362	38,0 1.496	11,2 0.441	3,0 0.118	130°	Senza rivestimento
SD26-1.49-9.20-3R1	02730740	1,49 0.059	9,2 0.362	38,0 1.496	11,2 0.441	3,0 0.118	130°	Senza rivestimento
SD26-1.50-9.20-3R1	02731638	1,5 0.059	9,2 0.362	38,0 1.496	11,2 0.441	3,0 0.118	130°	Senza rivestimento
SD26-1.51-11.20-3R1	02730741	1,51 0.059	11,2 0.441	38,0 1.496	13,4 0.528	3,0 0.118	130°	Senza rivestimento
SD26-1.52-11.20-3R1	02730742	1,52 0.060	11,2 0.441	38,0 1.496	13,4 0.528	3,0 0.118	130°	Senza rivestimento
SD26-1.53-11.20-3R1	02730743	1,53 0.060	11,2 0.441	38,0 1.496	13,4 0.528	3,0 0.118	130°	Senza rivestimento
SD26-1.54-11.20-3R1	02730744	1,54 0.061	11,2 0.441	38,0 1.496	13,4 0.528	3,0 0.118	130°	Senza rivestimento
SD26-1.55-11.20-3R1	02730745	1,55 0.061	11,2 0.441	38,0 1.496	13,4 0.528	3,0 0.118	130°	Senza rivestimento

Introduzione

Foratura

Alesatura

Barenatura

Allegato

Codice di ordinazione	Codice prodotto	DC	LU	OAL	LUX	DMM	Angolo di punta	Rivestimento
		mm Inch	mm Inch	mm Inch	mm Inch	mm Inch		
SD26-1.56-11.20-3R1	02730746	1,56 0.061	11,2 0.441	38,0 1.496	13,4 0.528	3,0 0.118	130°	Senza rivestimento
SD26-1.57-11.20-3R1	02730747	1,57 0.062	11,2 0.441	38,0 1.496	13,4 0.528	3,0 0.118	130°	Senza rivestimento
SD26-1.58-11.20-3R1	02730748	1,58 0.062	11,2 0.441	38,0 1.496	13,4 0.528	3,0 0.118	130°	Senza rivestimento
SD26-1.59-11.20-3R1	02730749	1,59 0.063	11,2 0.441	38,0 1.496	13,4 0.528	3,0 0.118	130°	Senza rivestimento
SD26-1.60-11.20-3R1	02731639	1,6 0.063	11,2 0.441	38,0 1.496	13,4 0.528	3,0 0.118	130°	Senza rivestimento
SD26-1.61-11.20-3R1	02730750	1,61 0.063	11,2 0.441	38,0 1.496	13,4 0.528	3,0 0.118	130°	Senza rivestimento
SD26-1.62-11.20-3R1	02730751	1,62 0.064	11,2 0.441	38,0 1.496	13,4 0.528	3,0 0.118	130°	Senza rivestimento
SD26-1.63-11.20-3R1	02730752	1,63 0.064	11,2 0.441	38,0 1.496	13,4 0.528	3,0 0.118	130°	Senza rivestimento
SD26-1.64-11.20-3R1	02730753	1,64 0.065	11,2 0.441	38,0 1.496	13,4 0.528	3,0 0.118	130°	Senza rivestimento
SD26-1.65-11.20-3R1	02730754	1,65 0.065	11,2 0.441	38,0 1.496	13,4 0.528	3,0 0.118	130°	Senza rivestimento
SD26-1.66-11.20-3R1	02730755	1,66 0.065	11,2 0.441	38,0 1.496	13,4 0.528	3,0 0.118	130°	Senza rivestimento
SD26-1.67-11.20-3R1	02730756	1,67 0.066	11,2 0.441	38,0 1.496	13,4 0.528	3,0 0.118	130°	Senza rivestimento
SD26-1.68-11.20-3R1	02730757	1,68 0.066	11,2 0.441	38,0 1.496	13,4 0.528	3,0 0.118	130°	Senza rivestimento
SD26-1.69-11.20-3R1	02730758	1,69 0.067	11,2 0.441	38,0 1.496	13,4 0.528	3,0 0.118	130°	Senza rivestimento
SD26-1.70-11.20-3R1	02731640	1,7 0.067	11,2 0.441	38,0 1.496	13,4 0.528	3,0 0.118	130°	Senza rivestimento
SD26-1.71-11.20-3R1	02730759	1,71 0.067	11,2 0.441	38,0 1.496	13,4 0.528	3,0 0.118	130°	Senza rivestimento
SD26-1.72-11.20-3R1	02730760	1,72 0.068	11,2 0.441	38,0 1.496	13,4 0.528	3,0 0.118	130°	Senza rivestimento
SD26-1.73-11.20-3R1	02730761	1,73 0.068	11,2 0.441	38,0 1.496	13,4 0.528	3,0 0.118	130°	Senza rivestimento
SD26-1.74-11.20-3R1	02730762	1,74 0.069	11,2 0.441	38,0 1.496	13,4 0.528	3,0 0.118	130°	Senza rivestimento
SD26-1.75-11.20-3R1	02730763	1,75 0.069	11,2 0.441	38,0 1.496	13,4 0.528	3,0 0.118	130°	Senza rivestimento
SD26-1.76-11.20-3R1	02730764	1,76 0.069	11,2 0.441	38,0 1.496	13,4 0.528	3,0 0.118	130°	Senza rivestimento
SD26-1.77-11.20-3R1	02730765	1,77 0.070	11,2 0.441	38,0 1.496	13,4 0.528	3,0 0.118	130°	Senza rivestimento
SD26-1.78-11.20-3R1	02730766	1,78 0.070	11,2 0.441	38,0 1.496	13,4 0.528	3,0 0.118	130°	Senza rivestimento
SD26-1.79-11.20-3R1	02730767	1,79 0.070	11,2 0.441	38,0 1.496	13,4 0.528	3,0 0.118	130°	Senza rivestimento
SD26-1.80-11.20-3R1	02731641	1,8 0.071	11,2 0.441	38,0 1.496	13,4 0.528	3,0 0.118	130°	Senza rivestimento
SD26-1.81-11.20-3R1	02730768	1,81 0.071	11,2 0.441	38,0 1.496	13,4 0.528	3,0 0.118	130°	Senza rivestimento
SD26-1.82-11.20-3R1	02730769	1,82 0.072	11,2 0.441	38,0 1.496	13,4 0.528	3,0 0.118	130°	Senza rivestimento
SD26-1.83-11.20-3R1	02730770	1,83 0.072	11,2 0.441	38,0 1.496	13,4 0.528	3,0 0.118	130°	Senza rivestimento
SD26-1.84-11.20-3R1	02730771	1,84 0.072	11,2 0.441	38,0 1.496	13,4 0.528	3,0 0.118	130°	Senza rivestimento
SD26-1.85-11.20-3R1	02730772	1,85 0.073	11,2 0.441	38,0 1.496	13,4 0.528	3,0 0.118	130°	Senza rivestimento
SD26-1.86-11.20-3R1	02730773	1,86 0.073	11,2 0.441	38,0 1.496	13,4 0.528	3,0 0.118	130°	Senza rivestimento

Codice di ordinazione	Codice prodotto	DC	LU	OAL	LUX	DMM	Angolo di punta	Rivestimento
		mm <i>Inch</i>	mm <i>Inch</i>	mm <i>Inch</i>	mm <i>Inch</i>	mm <i>Inch</i>		
SD26-1.87-11.20-3R1	02730774	1,87 <i>0.074</i>	11,2 <i>0.441</i>	38,0 <i>1.496</i>	13,4 <i>0.528</i>	3,0 <i>0.118</i>	130°	Senza rivestimento
SD26-1.88-11.20-3R1	02730775	1,88 <i>0.074</i>	11,2 <i>0.441</i>	38,0 <i>1.496</i>	13,4 <i>0.528</i>	3,0 <i>0.118</i>	130°	Senza rivestimento
SD26-1.89-11.20-3R1	02730776	1,89 <i>0.074</i>	11,2 <i>0.441</i>	38,0 <i>1.496</i>	13,4 <i>0.528</i>	3,0 <i>0.118</i>	130°	Senza rivestimento
SD26-1.90-11.20-3R1	02731642	1,9 <i>0.075</i>	11,2 <i>0.441</i>	38,0 <i>1.496</i>	13,4 <i>0.528</i>	3,0 <i>0.118</i>	130°	Senza rivestimento
SD26-1.91-11.20-3R1	02730777	1,91 <i>0.075</i>	11,2 <i>0.441</i>	38,0 <i>1.496</i>	13,4 <i>0.528</i>	3,0 <i>0.118</i>	130°	Senza rivestimento
SD26-1.92-11.20-3R1	02730778	1,92 <i>0.076</i>	11,2 <i>0.441</i>	38,0 <i>1.496</i>	13,4 <i>0.528</i>	3,0 <i>0.118</i>	130°	Senza rivestimento
SD26-1.93-11.20-3R1	02730779	1,93 <i>0.076</i>	11,2 <i>0.441</i>	38,0 <i>1.496</i>	13,4 <i>0.528</i>	3,0 <i>0.118</i>	130°	Senza rivestimento
SD26-1.94-11.20-3R1	02730780	1,94 <i>0.076</i>	11,2 <i>0.441</i>	38,0 <i>1.496</i>	13,4 <i>0.528</i>	3,0 <i>0.118</i>	130°	Senza rivestimento
SD26-1.95-11.20-3R1	02730781	1,95 <i>0.077</i>	11,2 <i>0.441</i>	38,0 <i>1.496</i>	13,4 <i>0.528</i>	3,0 <i>0.118</i>	130°	Senza rivestimento
SD26-1.96-11.20-3R1	02730782	1,96 <i>0.077</i>	11,2 <i>0.441</i>	38,0 <i>1.496</i>	13,4 <i>0.528</i>	3,0 <i>0.118</i>	130°	Senza rivestimento
SD26-1.97-11.20-3R1	02730783	1,97 <i>0.078</i>	11,2 <i>0.441</i>	38,0 <i>1.496</i>	13,4 <i>0.528</i>	3,0 <i>0.118</i>	130°	Senza rivestimento
SD26-1.98-11.20-3R1	02730784	1,98 <i>0.078</i>	11,2 <i>0.441</i>	38,0 <i>1.496</i>	13,4 <i>0.528</i>	3,0 <i>0.118</i>	130°	Senza rivestimento
SD26-1.99-11.20-3R1	02730785	1,99 <i>0.078</i>	11,2 <i>0.441</i>	38,0 <i>1.496</i>	13,4 <i>0.528</i>	3,0 <i>0.118</i>	130°	Senza rivestimento
SD26-2.00-11.20-3R1	02731643	2,0 <i>0.079</i>	11,2 <i>0.441</i>	38,0 <i>1.496</i>	13,4 <i>0.528</i>	3,0 <i>0.118</i>	130°	Senza rivestimento

Introduzione

Foratura

Alesatura

Barenatura

Allegato

Parametri di lavorazione

Potenza assorbita

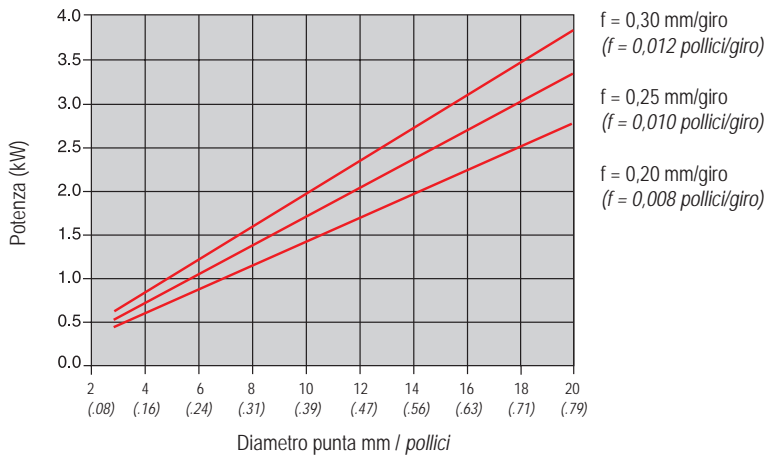

Portata refrigerante a diverse pressioni

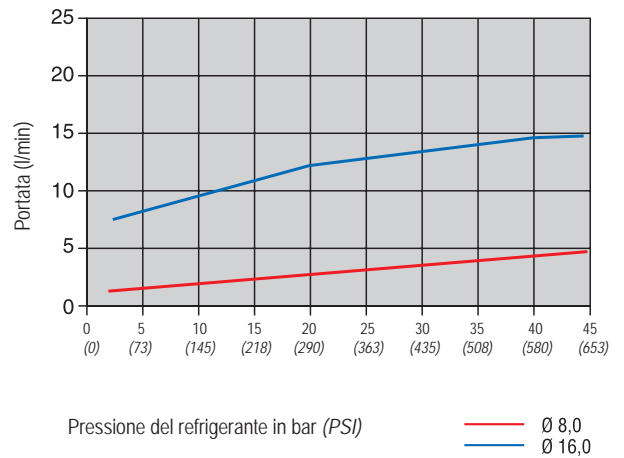

Forza di avanzamento

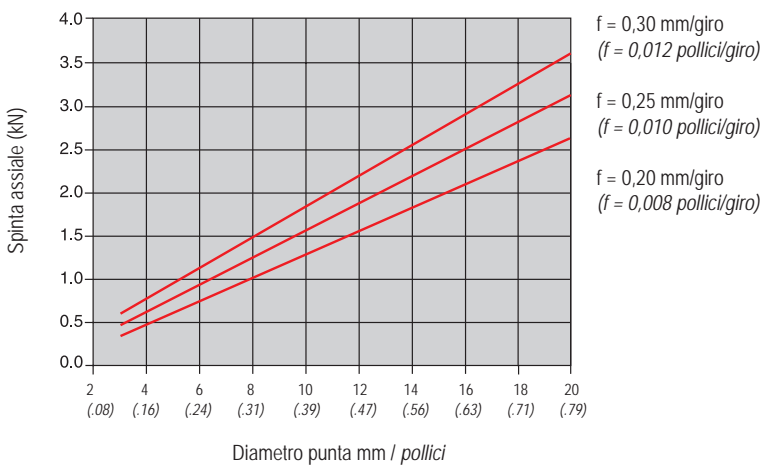

Metodo:

Regolare con piccole variazioni l'avanzamento per ottimizzare la forma dei trucioli.

Aumentare l'avanzamento/giro per ottenere trucioli più corti.

I valori relativi alla spinta assiale ed alla potenza assorbita sono indicativi e variano a seconda del materiale, del valore dell'usura e dei parametri di taglio.







Parametri di lavorazione

SD1103, SD1103A, SD1105A, SD203A, SD205A, SD206, SD206A, SD207A, SD216A, SD230A IT8-9/R _a 1-3*					
\varnothing punta DC (mm)	Tolleranza IT9 (μm)	Tolleranza IT10 (μm)	\varnothing Punta DC (pollici)	Tolleranza IT9 (pollici)	Tolleranza IT10 (pollici)
< 3	14	25	-0.118	0.0006	0.0010
3-6	18	30	> 0.118-0.236	0.0007	0.0012
6-10	22	36	> 0.236-0.394	0.0009	0.0014
10-18	27	43	> 0.394-0.709	0.0011	0.0017
> 18	33	52	> 0.709	0.0013	0.0020

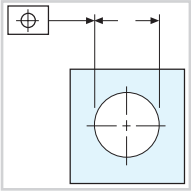
*Quando si forano acciai inossidabili e acciai a basso tenore di carbonio, si può verificare un deterioramento della finitura superficiale.

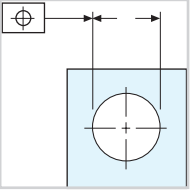
Problemi e soluzioni – Verifiche iniziali

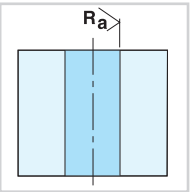
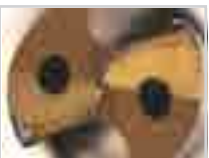
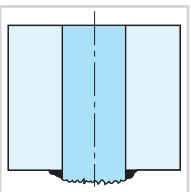
- Stabilità del fissaggio
- Condizioni del mandrino macchina
- Condizioni del portautensile
- Bloccaggio dell'utensile:
 - Eccentricità totale entro 0,04 TIR
 - Con pre-foratura entro 0,04 TIR
- Evacuazione del truciolo:
 - Parametri di taglio
- Refrigerante:
 - Pressione
 - Flusso
 - Concentrazione

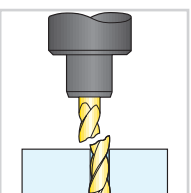
<p>Rapida usura sul fianco</p> <ul style="list-style-type: none"> • Ridurre la velocità di taglio • Aumentare la concentrazione del refrigerante 		<p>Tolleranza diametro non soddisfacente</p> <ul style="list-style-type: none"> • Aumentare l'avanzamento/giro • Effettuare un'operazione di alesatura, vedere le pagine 327 • Effettuare un'operazione di barenatura, vedere le pagine 516-517 	
<p>Usura del bordino esterno</p> <ul style="list-style-type: none"> • Ridurre la velocità di taglio • Aumentare la concentrazione del refrigerante 		<p>Posizione foro non soddisfacente</p> <ul style="list-style-type: none"> • Ridurre l'avanzamento/giro in entrata • Ridurre l'avanzamento/giro • Effettuare un'operazione di barenatura, vedere le pagine 516-517 • Quando si forano superfici grezze, dure o inclinate, ridurre l'avanzamento del 30-50% in fase di entrata e uscita • Fare centrino con una punta a 140° 	
<p>Scheggiature al centro</p> <ul style="list-style-type: none"> • Ridurre l'avanzamento/giro in entrata • Ridurre l'avanzamento/giro • Effettuare un'operazione di barenatura, vedere le pagine 516-517 		<p>Cattiva finitura superficiale</p> <ul style="list-style-type: none"> • Ridurre l'avanzamento al giro • Aumentare la velocità di taglio • Effettuare un'operazione di alesatura, vedere pagina 327 	
<p>Scheggiature del tagliente, anche periferiche</p> <ul style="list-style-type: none"> • Ridurre l'avanzamento in fase di entrata e uscita • Ridurre la velocità di taglio • Aumentare la concentrazione del refrigerante • Riaffilare la punta 		<p>Bave in uscita</p> <ul style="list-style-type: none"> • Ridurre l'avanzamento/giro in fase di uscita • Ridurre la fascetta di rinforzo del tagliente (BN) 	
<p>Formazione del tagliente di riporto</p> <ul style="list-style-type: none"> • Avvicinandosi alla parte periferica, aumentare la velocità di taglio • Avvicinandosi al centro, aumentare l'avanzamento/giro • Se la punta è usurata, riaffilarla 		<p>Rottura da contatto/sul fondo del foro</p> <ul style="list-style-type: none"> • Ridurre l'avanzamento/giro in fase di entrata e uscita • Regolare i parametri di taglio per migliorare l'evacuazione dei trucioli 	

Istruzioni per la riaffilatura di SD1103, SD1103A, SD1105A, SD1108A e SD1112A

Specifiche:

Specifiche della mola diamantata per riaffilatura:

Mantello conico: mola forma 12A2 Dimensione grana D54 (figura 1).

Snocciolatura: mola forma 1A1 o 1V1 Dimensione grana D64-D46 (figure 2-3).

Smusso: mola forma 1A1 o 12A2 (figura 1).

Preparazione tagliente: fase negativa o spazzolatura (figura 4).

Importante:

- I taglienti devono essere uniformi su tutta la preparazione del tagliente.
- La preparazione dei taglienti deve essere applicata sull'intera lunghezza dei taglienti.

1. Affilatura a quattro sfaccettature

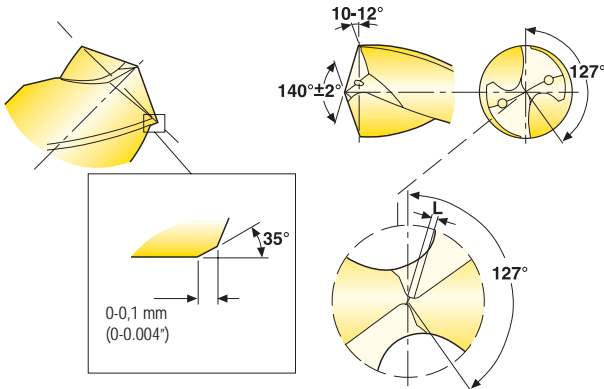

La differenza di altezza tra i due taglienti deve essere max. 0,02 mm (0,008")

2. Assottigliamento del nocciolo

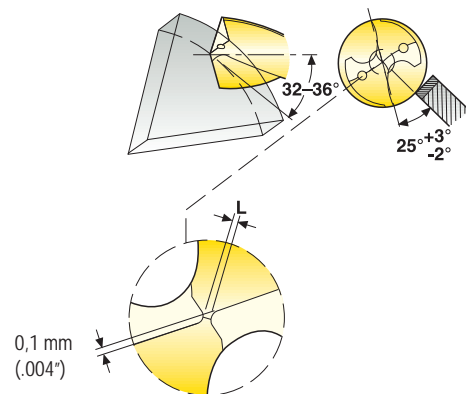

Ø Punta DC mm	L mm	Ø Punta DC pollici	L pollici
2-10	0,1-0,3	0.079-0.394	0.004-0.012
10-20	0,2-0,4	0.394-0.787	0.008-0.016

3. Affilatura del piano X

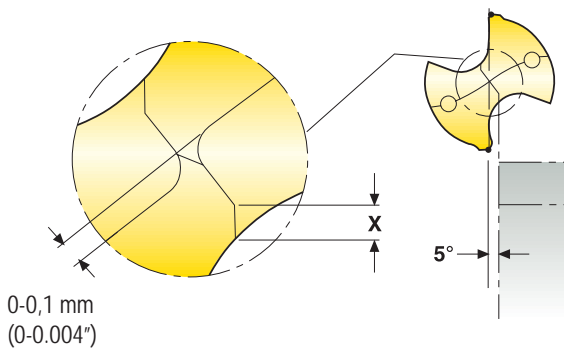

$$X = 0,08 \times (0,003) \times \text{diametro punta DC}$$

4. Preparazione del tagliente

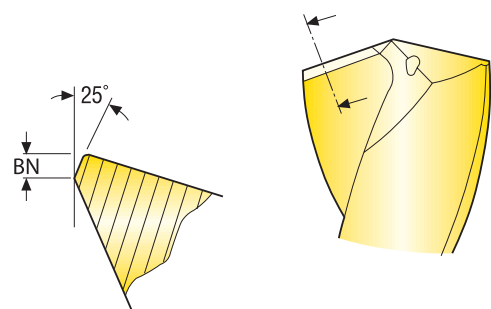

Materiale da lavorare	BN			
	Ø Punta ≤ 10 mm	Ø Punta > 10 mm	Ø Punta ≤ 0.394 pollici	Ø Punta > 0.394 pollici
Acciaio	0,05	0,10	0.002	0.004
Acciaio inossidabile	0,05	0,05	0.002	0.002
Ghisa	0,05	0,10	0.002	0.004

La massima usura sul fianco ammessa prima della riaffilatura è di 0,1-0,3 mm (0,004-0,012"), misurata al punto più largo.

Istruzioni per la riaffilatura di SD203A, SD205A e SD207A, geometria -P

Specifiche:

Specifiche della mola diamantata per riaffilatura:

Spoglia conica: mola forma 12A2 Dimensione grana D54 (figura 1).

Snocciolatura: mola forma 1A1 o 1V1 Dimensione grana D64-D46 (figure 2-3).

Smusso: mola forma 1A1 o 12A2 (figura 1).

Preparazione tagliente: fase negativa o spazzolatura (figura 4).

Importante:

▪ I taglienti devono essere uniformi su tutta la preparazione del tagliente.

▪ La preparazione del tagliente deve essere applicata sull'intera lunghezza dei taglienti.

1. Riaffilatura delle spoglie

La differenza di altezza tra i due taglienti deve essere max. 0,02 mm (0,008")

2. Assottigliamento del nocciolo

Ø Punta DC mm	L mm	Ø Punta DC pollici	L pollici
2-10	0,1-0,3	0.079-0.394	0.004-0.012
10-20	0,2-0,4	0.394-0.787	0.008-0.016

3. Affilatura del piano X

$X = 0,08 \times (0,003) \times \text{diametro punta DC}$

4. Preparazione del tagliente

Materiale da lavorare	BN			
	Ø Punta ≤ 10 mm	Ø Punta > 10 mm	Ø Punta ≤ 0.394 pollici	Ø Punta > 0.394 pollici
Acciaio	0,05	0,10	0.002	0.004
Acciaio inossidabile	0,05	0,05	0.002	0.002
Ghisa	0,05	0,10	0.002	0.004

La massima usura sul fianco ammessa prima della riaffilatura è di 0,1-0,3 mm (0,004-0,012"), misurata al punto più largo.

Istruzioni per la riaffilatura di punte per smussi

Le istruzioni per la riaffilatura sono le stesse delle punte SD203, SD203A, SD205A e SD207A, eccetto che per lo smusso.

Introduzione

Foratura

Alesatura

Barenatura

Allegato

1. Angolo di spoglia dello smusso

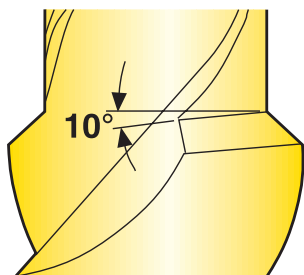

2. Preparazione tagliente, smusso

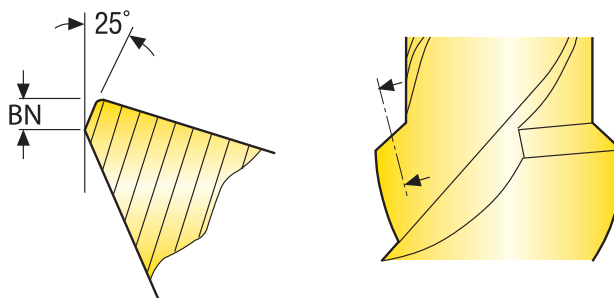

Materiale da lavorare	BN			
	Ø Punta ≤ 10 mm	Ø Punta > 10 mm	Ø Punta ≤ 0.394 pollici	Ø Punta > 0.394 pollici
Acciaio	0,05	0,05	0.002	0.002
Acciaio inossidabile	0,05	0,05	0.002	0.002
Ghisa	0,05	0,05	0.002	0.002

Istruzioni per la riaffilatura di SD212A, SD216A, SD220A, SD225A e SD230A

Specifiche:

Specifiche della mola diamantata per riaffilatura:

Mantello conico: mola forma 11V9 Dimensione grana D54 (figura 1).

Snocciolatura: mola forma 1A1 o 1V1 Dimensione grana D64-D46 (figure 2-3).

Smusso: mola forma 1A1 o 12A2 (figura 1).

Preparazione tagliente: fase negativa o spazzolatura (figura 4).

Importante:

- I taglienti devono essere uniformi su tutta la preparazione del tagliente.
- La preparazione dei taglienti deve essere applicata sull'intera lunghezza dei taglienti.

1. Riaffilatura delle spoglie

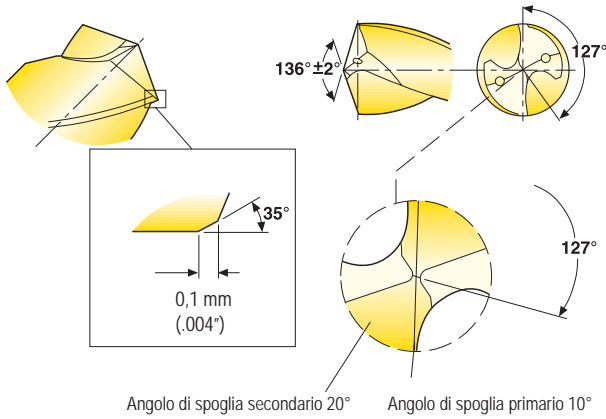

Angolo di spoglia secondario 20° Angolo di spoglia primario 10°

La differenza di altezza tra i due taglienti deve essere max. 0,02 mm (0,008")

2. Assottigliamento del nocciolo

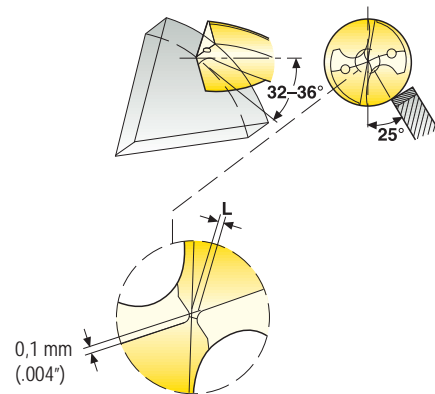

Ø Punta DC mm	L mm	Ø Punta DC pollici	L pollici
2-10	0,2	0.079-0.394	0.008
10-20	0,4	0.394-0.787	0.016

3. Affilatura del piano X

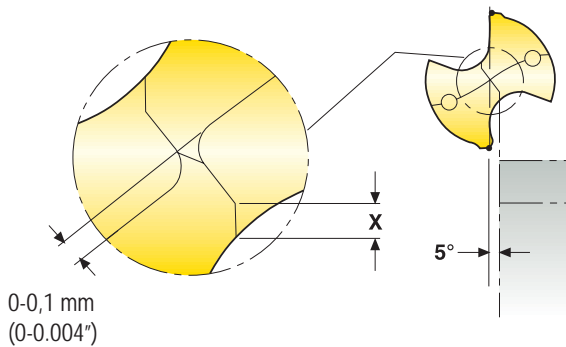

$$X = 0,08 \times (0,003) \times \text{diametro punta DC}$$

4. Preparazione del tagliente

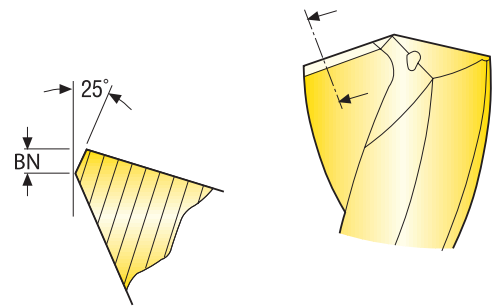

Materiale da lavorare	BN			
	Ø Punta ≤ 10 mm	Ø Punta > 10 mm	Ø Punta ≤ 0.394 pollici	Ø Punta > 0.394 pollici
Acciaio	0,05	0,10	0.002	0.004
Acciaio inossidabile	0,05	0,05	0.002	0.002
Ghisa	0,05	0,10	0.002	0.004

La massima usura sul fianco ammessa prima della riaffilatura è di 0,1-0,3 mm (0,004-0,012"), misurata al punto più largo.

Istruzioni per la riaffilatura di SD243, SD243A, SD245A e SD247A

Introduzione

Foratura

Alesatura

Barenatura

Allegato

1. Angolo di punta

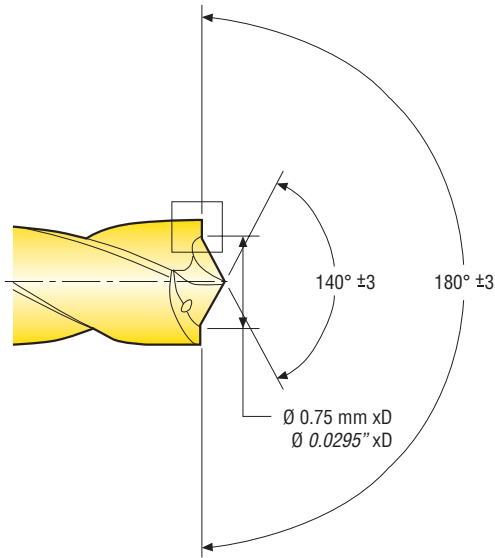

2. Smusso

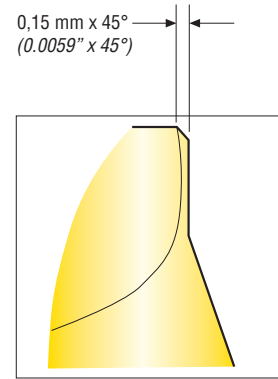

3.

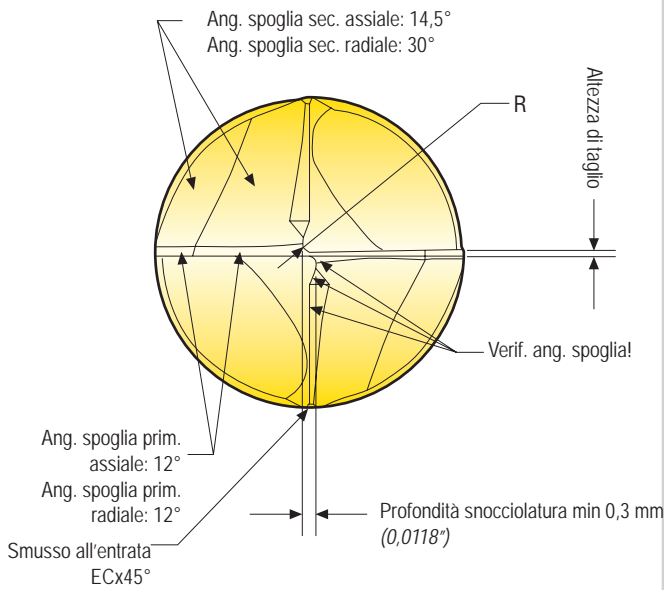

Dimensioni in mm (pollici)	Altezza di taglio mm (pollici)	R mm (pollici)	EC mm (pollici)
- 10 (0.3937)	0,2 (0.0079)	0,2 (0.0079)	0,3 (0.0118)
10,01 (0.3941) -	0,3 (0.0118)	0,4 (0.0157)	0,5 (0.0197)

4. Preparazione del tagliente

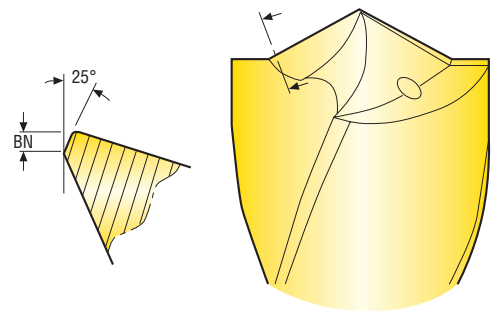

Materiale da lavorare	BN			
	Ø Punta ≤ 10 mm	Ø Punta > 10 mm	Ø Punta ≤ 0.394 pollici	Ø Punta > 0.394 pollici
Acciaio	0,05	0,10	0,002	0,004
Acciaio inossidabile	0,05	0,05	0,002	0,002
Ghisa	0,05	0,10	0,002	0,004

Istruzioni per la riaffilatura di SD265A

Specifiche:

Specifiche della mola diamantata per riaffilatura:

Spoglia conica: mola forma 12A2 Dimensione grana D54 (figura 1).

Snocciolatura: mola forma 1A1 o 1V1 Dimensione grana D64-D46 (figure 2-3).

Smusso: mola forma 1A1 o 12A2 (figura 1).

Preparazione tagliente: fase negativa o spazzolatura (figura 4).

Importante:

- I taglienti devono essere uniformi su tutta la preparazione del tagliente.
- La preparazione dei taglienti deve essere applicata sull'intera lunghezza dei taglienti.

1. Riaffilatura delle spoglie

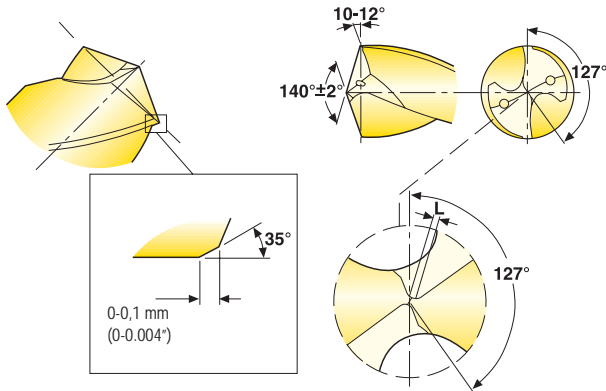

La differenza di altezza tra i due taglienti deve essere max. 0,02 mm (0,008")

2. Assottigliamento del nocciolo

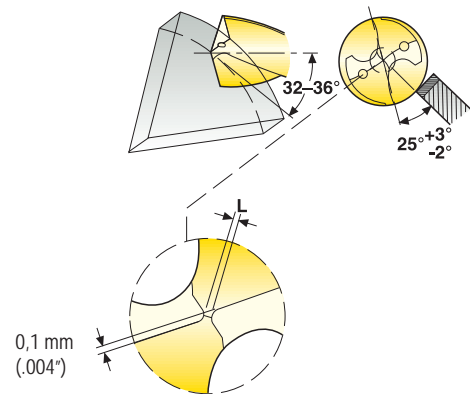

Ø Punta DC mm	L mm	Ø Punta DC pollici	L pollici
2-10	0,2	0.079-0.394	0.008
10-20	0,4	0.394-0.787	0.016

3. Affilatura del piano X

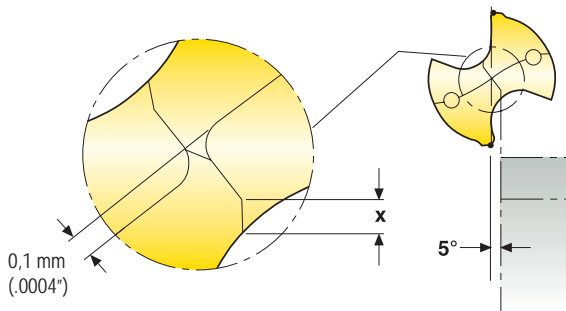

$$X = 0,08 \times (0,003) \times \text{diametro punta DC}$$

4. Preparazione del tagliente

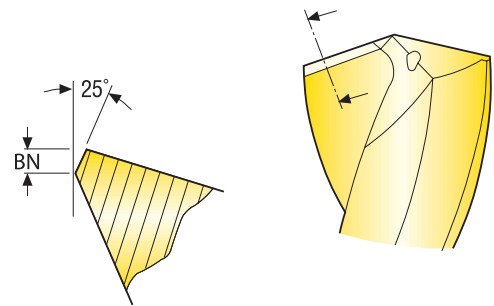

Materiale da lavorare	BN			
	Ø Punta ≤ 10 mm	Ø Punta > 10 mm	Ø Punta ≤ 0.394 pollici	Ø Punta > 0.394 pollici
Acciaio	0,05	0,10	0.002	0.004
Acciaio inossidabile	0,05	0,05	0.002	0.002
Ghisa	0,05	0,10	0.002	0.004

La massima usura sul fianco ammessa prima della riaffilatura è di 0,1-0,3 mm (0,004-0,012"), misurata al punto più largo.

Istruzioni per la riaffilatura di punte con geometria -MS

Specifiche:

Specifiche della mola diamantata per riaffilatura:

Spoglia conica: mola forma 12A2 Dimensione grana D54 (figura 1).

Snocciolatura: mola forma 1A1 o 1V1 Dimensione grana D64-D46 (figura 2-3).

Smusso: mola forma 1A1 o 12A2 (figura 1).

Preparazione tagliente: fase negativa o spazzolatura (figura 4).

Importante:

- I taglienti devono essere uniformi su tutta la preparazione del tagliente.
- La preparazione dei taglienti deve essere applicata sull'intera lunghezza dei taglienti.

Introduzione

Foratura

Alesatura

Barenatura

Allegato

1. Quattro sfaccettature

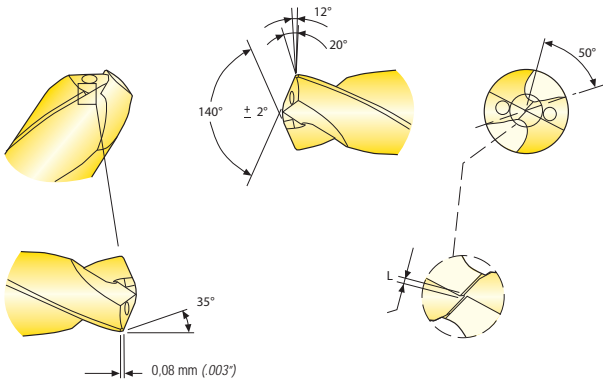

La differenza di altezza tra i due taglienti deve essere max. 0,02 mm (0,008")

2. Affilatura del raggio R

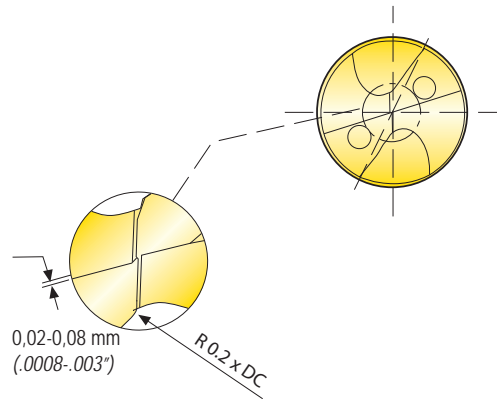

3. Assottigliamento del nocciolo

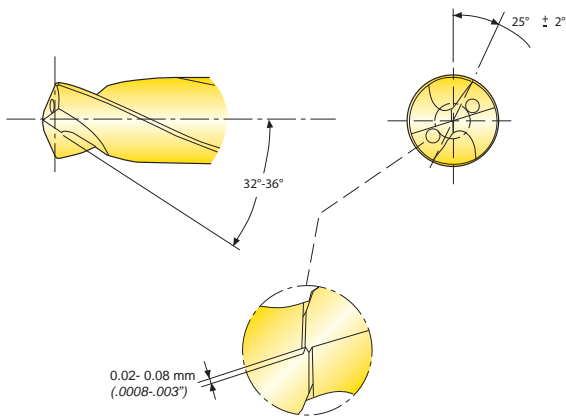

4. Preparazione del tagliente

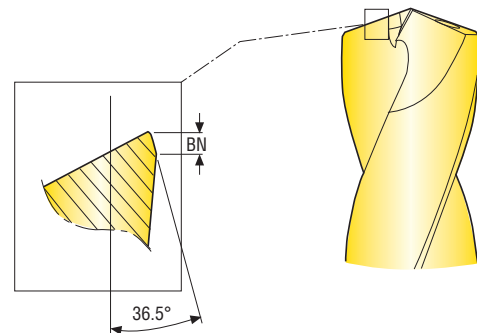

Ø Punta DC mm	BN mm	Ø Punta DC pollici	BN pollici
2-3	0,2	0.079-0.118	0.00787
3-6	0,025	0.118-0.236	0.00098
6-10	0,04	0.236-0.394	0.00157
10-20	0,055	0.394-0.787	0.00216
20-	0,07	0.787-	0.00275

La massima usura sul fianco ammessa prima della riaffilatura è di 0,1-0,3 mm (0,004-0,012"), misurata al punto più largo.

Istruzioni per la riaffilatura di punte con geometria -M e -T

Specifiche:

Specifiche della mola diamantata per riaffilatura:

Spoglia conica: mola forma 12A2 Dimensione grana D54 (figura 1).

Snocciolatura: mola forma 1A1 o 1V1 Dimensione grana D64-D46 (figura 2-3).

Smusso: mola forma 1A1 o 12A2 (figura 1).

Preparazione tagliente: fase negativa o spazzolatura (figura 4).

Importante:

- I taglienti devono essere uniformi su tutta la preparazione del tagliente.
- La preparazione dei taglienti deve essere applicata sull'intera lunghezza dei taglienti.

1. Riaffilatura delle spoglie

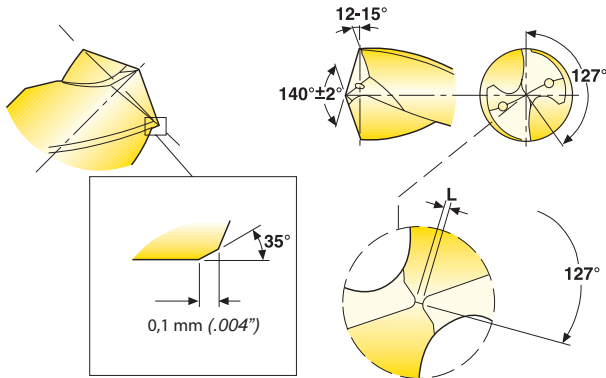

La differenza di altezza tra i due taglienti deve essere max. 0,01 mm (0,0004'')

2. Assottigliamento del nocciolo

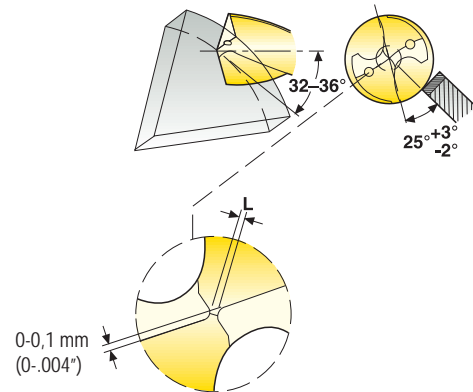

Ø Punta DC mm	L mm	Ø Punta DC pollici	L pollici
3-6	0,1-0,2	0.118-0.236	0.004-0.008
6-10	0,13-0,27	0.236-0.394	0.005-0.011
10-20	0,2-0,4	0.394-0.787	0.008-0.016

3. Affilatura del piano X

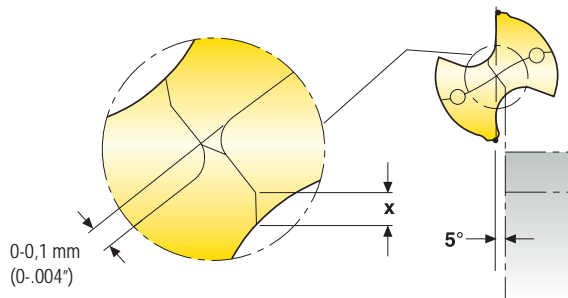

4. Preparazione del tagliente

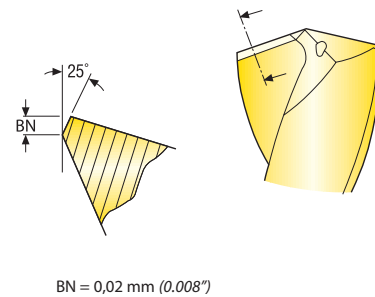

BN = 0,02 mm (0,008'')

La massima usura sul fianco ammessa prima della riaffilatura è di 0,1-0,3 mm (0,004-0,012''), misurata al punto più largo.

SD1103 – Ø 3-20 mm / 0.118-0.787 pollici

SMG	f										V _c
	Ø 3,00 Ø 0.118	Ø 4,00 Ø 0.157	Ø 6,00 Ø 0.236	Ø 8,00 Ø 0.315	Ø 10,00 Ø 0.394	Ø 12,00 Ø 0.472	Ø 14,00 Ø 0.551	Ø 16,00 Ø 0.630	Ø 18,00 Ø 0.709	Ø 20,00 Ø 0.787	
P1	0,12	0,14	0,18	0,22	0,25	0,28	0,30	0,32	0,34	0,36	105
	0.0048	0.0055	0.0070	0.0085	0.010	0.011	0.012	0.013	0.013	0.014	345
P2	0,12	0,14	0,18	0,22	0,26	0,28	0,32	0,34	0,36	0,36	105
	0.0048	0.0055	0.0070	0.0085	0.010	0.011	0.013	0.013	0.014	0.014	345
P3	0,11	0,13	0,17	0,20	0,24	0,28	0,30	0,32	0,34	0,34	90
	0.0044	0.0050	0.0065	0.0080	0.0095	0.011	0.012	0.013	0.013	0.013	295
P4	0,11	0,13	0,17	0,20	0,24	0,26	0,28	0,30	0,32	0,34	80
	0.0044	0.0050	0.0065	0.0080	0.0095	0.010	0.011	0.012	0.013	0.013	260
P5	0,11	0,13	0,16	0,20	0,24	0,26	0,28	0,30	0,32	0,34	75
	0.0044	0.0050	0.0065	0.0080	0.0095	0.010	0.011	0.012	0.013	0.013	245
P6	0,11	0,12	0,16	0,20	0,24	0,26	0,28	0,30	0,32	0,34	85
	0.0044	0.0048	0.0065	0.0080	0.0095	0.010	0.011	0.012	0.013	0.013	280
P7	0,11	0,12	0,16	0,20	0,24	0,26	0,28	0,30	0,32	0,34	80
	0.0044	0.0048	0.0065	0.0080	0.0095	0.010	0.011	0.012	0.013	0.013	260
P8	0,11	0,13	0,17	0,20	0,24	0,28	0,30	0,32	0,34	0,34	75
	0.0044	0.0050	0.0065	0.0080	0.0095	0.011	0.012	0.013	0.013	0.013	245
P11	0,11	0,12	0,16	0,20	0,24	0,26	0,28	0,30	0,32	0,34	75
	0.0044	0.0048	0.0065	0.0080	0.0095	0.010	0.011	0.012	0.013	0.013	245
P12	0,075	0,085	0,11	0,14	0,16	0,18	0,19	0,20	0,22	0,22	46
	0.0030	0.0034	0.0044	0.0055	0.0065	0.0070	0.0075	0.0080	0.0085	0.0085	150
M1	0,080	0,095	0,13	0,17	0,20	0,22	0,24	0,26	0,28	0,30	55
	0.0032	0.0038	0.0050	0.0065	0.0080	0.0085	0.0095	0.010	0.011	0.012	180
M2	0,070	0,085	0,12	0,15	0,18	0,20	0,22	0,24	0,25	0,26	45
	0.0028	0.0034	0.0048	0.0060	0.0070	0.0080	0.0085	0.0095	0.010	0.010	150
K1	0,12	0,14	0,18	0,22	0,26	0,28	0,30	0,34	0,34	0,36	70
	0.0048	0.0055	0.0070	0.0085	0.010	0.011	0.012	0.013	0.013	0.014	230
K2	0,11	0,13	0,16	0,20	0,24	0,26	0,28	0,30	0,32	0,34	60
	0.0044	0.0050	0.0065	0.0080	0.0095	0.010	0.011	0.012	0.013	0.013	195
K3	0,11	0,13	0,16	0,20	0,24	0,26	0,28	0,30	0,32	0,34	50
	0.0044	0.0050	0.0065	0.0080	0.0095	0.010	0.011	0.012	0.013	0.013	165
K4	0,11	0,13	0,16	0,20	0,24	0,26	0,28	0,30	0,32	0,34	49
	0.0044	0.0050	0.0065	0.0080	0.0095	0.010	0.011	0.012	0.013	0.013	160
K5	0,10	0,11	0,15	0,18	0,20	0,24	0,25	0,28	0,28	0,30	29
	0.0040	0.0044	0.0060	0.0070	0.0080	0.0095	0.010	0.011	0.011	0.012	95
H3	0,048	0,055	0,075	0,090	0,10	0,12	0,13	0,14	0,14	0,15	24
	0.0019	0.0022	0.0030	0.0036	0.0040	0.0048	0.0050	0.0055	0.0055	0.0060	80
H5	0,075	0,085	0,11	0,14	0,16	0,18	0,19	0,20	0,22	0,22	45
	0.0030	0.0034	0.0044	0.0055	0.0065	0.0070	0.0075	0.0080	0.0085	0.0085	150
H7	0,048	0,055	0,075	0,090	0,10	0,12	0,13	0,14	0,14	0,15	24
	0.0019	0.0022	0.0030	0.0036	0.0040	0.0048	0.0050	0.0055	0.0055	0.0060	80
H8	0,055	0,065	0,085	0,10	0,12	0,14	0,15	0,16	0,17	0,17	45
	0.0022	0.0026	0.0034	0.0040	0.0048	0.0055	0.0060	0.0065	0.0065	0.0065	150
H11	0,075	0,085	0,11	0,14	0,16	0,18	0,19	0,20	0,22	0,22	60
	0.0030	0.0034	0.0044	0.0055	0.0065	0.0070	0.0075	0.0080	0.0085	0.0085	195
H12	0,055	0,065	0,085	0,10	0,12	0,14	0,15	0,16	0,17	0,17	27
	0.0022	0.0026	0.0034	0.0040	0.0048	0.0055	0.0060	0.0065	0.0065	0.0065	90

SMG = Gruppo materiale Seco
f = mm/giro
V_c = m/min
Tutti i parametri di taglio sono valori di partenza

Barenatura

Allegato

SMG	f										v _c
	Ø 3,00 Ø 0.118	Ø 4,00 Ø 0.157	Ø 6,00 Ø 0.236	Ø 8,00 Ø 0.315	Ø 10,00 Ø 0.394	Ø 12,00 Ø 0.472	Ø 14,00 Ø 0.551	Ø 16,00 Ø 0.630	Ø 18,00 Ø 0.709	Ø 20,00 Ø 0.787	
P1	0,12 0.0048	0,14 0.0055	0,18 0.0070	0,22 0.0085	0,25 0.010	0,28 0.011	0,30 0.012	0,32 0.013	0,34 0.013	0,36 0.014	150 490
P2	0,12 0.0048	0,14 0.0055	0,18 0.0070	0,22 0.0085	0,26 0.010	0,28 0.011	0,32 0.013	0,34 0.013	0,36 0.014	0,36 0.014	145 475
P3	0,11 0.0044	0,13 0.0050	0,17 0.0065	0,20 0.0080	0,24 0.0095	0,28 0.011	0,30 0.012	0,32 0.013	0,34 0.013	0,34 0.013	125 410
P4	0,11 0.0044	0,13 0.0050	0,17 0.0065	0,20 0.0080	0,24 0.0095	0,26 0.010	0,28 0.011	0,30 0.012	0,32 0.013	0,34 0.013	110 360
P5	0,11 0.0044	0,13 0.0050	0,16 0.0065	0,20 0.0080	0,24 0.0095	0,26 0.010	0,28 0.011	0,30 0.012	0,32 0.013	0,34 0.013	105 345
P6	0,11 0.0044	0,12 0.0048	0,16 0.0065	0,20 0.0080	0,24 0.0095	0,26 0.010	0,28 0.011	0,30 0.012	0,32 0.013	0,34 0.013	120 395
P7	0,11 0.0044	0,12 0.0048	0,16 0.0065	0,20 0.0080	0,24 0.0095	0,26 0.010	0,28 0.011	0,30 0.012	0,32 0.013	0,34 0.013	110 360
P8	0,11 0.0044	0,13 0.0050	0,17 0.0065	0,20 0.0080	0,24 0.0095	0,28 0.011	0,30 0.012	0,32 0.013	0,34 0.013	0,34 0.013	105 345
P11	0,11 0.0044	0,12 0.0048	0,16 0.0065	0,20 0.0080	0,24 0.0095	0,26 0.010	0,28 0.011	0,30 0.012	0,32 0.013	0,34 0.013	75 245
P12	0,075 0.0030	0,085 0.0034	0,11 0.0044	0,14 0.0055	0,16 0.0065	0,18 0.0070	0,19 0.0075	0,20 0.0080	0,22 0.0085	0,22 0.0085	50 165
M1	0,080 0.0032	0,095 0.0038	0,13 0.0050	0,17 0.0065	0,20 0.0080	0,22 0.0085	0,24 0.0095	0,26 0.010	0,28 0.011	0,30 0.012	80 260
M2	0,070 0.0028	0,085 0.0034	0,12 0.0048	0,15 0.0060	0,18 0.0070	0,20 0.0080	0,22 0.0085	0,24 0.0095	0,25 0.010	0,26 0.010	65 215
M3	0,055 0.0022	0,070 0.0028	0,095 0.0038	0,12 0.0048	0,14 0.0055	0,16 0.0065	0,18 0.0070	0,19 0.0075	0,20 0.0080	0,22 0.0085	48 155
M4	0,050 0.0020	0,060 0.0024	0,085 0.0034	0,11 0.0044	0,12 0.0048	0,14 0.0055	0,15 0.0060	0,17 0.0065	0,18 0.0070	0,19 0.0075	36 120
M5	0,050 0.0020	0,060 0.0024	0,085 0.0034	0,11 0.0044	0,12 0.0048	0,14 0.0055	0,15 0.0060	0,17 0.0065	0,18 0.0070	0,19 0.0075	30 100
K1	0,12 0.0048	0,14 0.0055	0,18 0.0070	0,22 0.0085	0,26 0.010	0,28 0.011	0,30 0.012	0,34 0.013	0,34 0.013	0,36 0.014	95 310
K2	0,11 0.0044	0,13 0.0050	0,16 0.0065	0,20 0.0080	0,24 0.0095	0,26 0.010	0,28 0.011	0,30 0.012	0,32 0.013	0,34 0.013	80 260
K3	0,11 0.0044	0,13 0.0050	0,16 0.0065	0,20 0.0080	0,24 0.0095	0,26 0.010	0,28 0.011	0,30 0.012	0,32 0.013	0,34 0.013	70 230
K4	0,11 0.0044	0,13 0.0050	0,16 0.0065	0,20 0.0080	0,24 0.0095	0,26 0.010	0,28 0.011	0,30 0.012	0,32 0.013	0,34 0.013	65 215
K5	0,10 0.0040	0,11 0.0044	0,15 0.0060	0,18 0.0070	0,20 0.0080	0,24 0.0095	0,25 0.010	0,28 0.011	0,28 0.011	0,30 0.012	39 130
N1	0,15 0.0060	0,17 0.0065	0,22 0.0085	0,25 0.010	0,28 0.011	0,32 0.013	0,34 0.013	0,36 0.014	0,38 0.015	0,40 0.016	260 850
N2	0,15 0.0060	0,17 0.0065	0,22 0.0085	0,25 0.010	0,28 0.011	0,32 0.013	0,34 0.013	0,36 0.014	0,38 0.015	0,40 0.016	170 560
N3	0,15 0.0060	0,17 0.0065	0,22 0.0085	0,25 0.010	0,28 0.011	0,32 0.013	0,34 0.013	0,36 0.014	0,38 0.015	0,40 0.016	110 360
N11	0,15 0.0060	0,17 0.0065	0,22 0.0085	0,25 0.010	0,28 0.011	0,32 0.013	0,34 0.013	0,36 0.014	0,38 0.015	0,40 0.016	210 690
H3	0,048 0.0019	0,055 0.0022	0,075 0.0030	0,090 0.0036	0,10 0.0040	0,12 0.0048	0,13 0.0050	0,14 0.0055	0,14 0.0055	0,15 0.0060	34 110
H5	0,075 0.0030	0,085 0.0034	0,11 0.0044	0,14 0.0055	0,16 0.0065	0,18 0.0070	0,19 0.0075	0,20 0.0080	0,22 0.0085	0,22 0.0085	65 215
H7	0,048 0.0019	0,055 0.0022	0,075 0.0030	0,090 0.0036	0,10 0.0040	0,12 0.0048	0,13 0.0050	0,14 0.0055	0,14 0.0055	0,15 0.0060	34 110
H8	0,055 0.0022	0,065 0.0026	0,085 0.0034	0,10 0.0040	0,12 0.0048	0,14 0.0055	0,15 0.0060	0,16 0.0065	0,17 0.0065	0,17 0.0065	65 215
H11	0,075 0.0030	0,085 0.0034	0,11 0.0044	0,14 0.0055	0,16 0.0065	0,18 0.0070	0,19 0.0075	0,20 0.0080	0,22 0.0085	0,22 0.0085	80 260
H12	0,055 0.0022	0,065 0.0026	0,085 0.0034	0,10 0.0040	0,12 0.0048	0,14 0.0055	0,15 0.0060	0,16 0.0065	0,17 0.0065	0,17 0.0065	38 125

SMG = Gruppo materiale Seco
 f = mm/giro
 v_c = m/min
 Tutti i parametri di taglio sono valori di partenza

Introduzione

Foratura

Alesatura

Barenatura

Allegato

SMG	f										v _c
	Ø 3,00 Ø 0.118	Ø 4,00 Ø 0.157	Ø 6,00 Ø 0.236	Ø 8,00 Ø 0.315	Ø 10,00 Ø 0.394	Ø 12,00 Ø 0.472	Ø 14,00 Ø 0.551	Ø 16,00 Ø 0.630	Ø 18,00 Ø 0.709	Ø 20,00 Ø 0.787	
P1	0,12	0,14	0,18	0,22	0,25	0,28	0,30	0,32	0,34	0,36	120
	0.0048	0.0055	0.0070	0.0085	0.010	0.011	0.012	0.013	0.013	0.014	395
P2	0,12	0,14	0,18	0,22	0,26	0,28	0,32	0,34	0,36	0,36	115
	0.0048	0.0055	0.0070	0.0085	0.010	0.011	0.013	0.013	0.014	0.014	375
P3	0,11	0,13	0,17	0,20	0,24	0,28	0,30	0,32	0,34	0,34	100
	0.0044	0.0050	0.0065	0.0080	0.0095	0.011	0.012	0.013	0.013	0.013	330
P4	0,11	0,13	0,17	0,20	0,24	0,26	0,28	0,30	0,32	0,34	85
	0.0044	0.0050	0.0065	0.0080	0.0095	0.010	0.011	0.012	0.013	0.013	280
P5	0,11	0,13	0,16	0,20	0,24	0,26	0,28	0,30	0,32	0,34	85
	0.0044	0.0050	0.0065	0.0080	0.0095	0.010	0.011	0.012	0.013	0.013	280
P6	0,11	0,12	0,16	0,20	0,24	0,26	0,28	0,30	0,32	0,34	95
	0.0044	0.0048	0.0065	0.0080	0.0095	0.010	0.011	0.012	0.013	0.013	310
P7	0,11	0,12	0,16	0,20	0,24	0,26	0,28	0,30	0,32	0,34	90
	0.0044	0.0048	0.0065	0.0080	0.0095	0.010	0.011	0.012	0.013	0.013	295
P8	0,11	0,13	0,17	0,20	0,24	0,28	0,30	0,32	0,34	0,34	85
	0.0044	0.0050	0.0065	0.0080	0.0095	0.011	0.012	0.013	0.013	0.013	280
P11	0,11	0,12	0,16	0,20	0,24	0,26	0,28	0,30	0,32	0,34	60
	0.0044	0.0048	0.0065	0.0080	0.0095	0.010	0.011	0.012	0.013	0.013	195
P12	0,075	0,085	0,11	0,14	0,16	0,18	0,19	0,20	0,22	0,22	42
	0.0030	0.0034	0.0044	0.0055	0.0065	0.0070	0.0075	0.0080	0.0085	0.0085	140
M1	0,080	0,095	0,13	0,17	0,20	0,22	0,24	0,26	0,28	0,30	60
	0.0032	0.0038	0.0050	0.0065	0.0080	0.0085	0.0095	0.010	0.011	0.012	195
M2	0,070	0,085	0,12	0,15	0,18	0,20	0,22	0,24	0,25	0,26	50
	0.0028	0.0034	0.0048	0.0060	0.0070	0.0080	0.0085	0.0095	0.010	0.010	165
M3	0,055	0,070	0,095	0,12	0,14	0,16	0,18	0,19	0,20	0,22	38
	0.0022	0.0028	0.0038	0.0048	0.0055	0.0065	0.0070	0.0075	0.0080	0.0085	125
M4	0,050	0,060	0,085	0,11	0,12	0,14	0,15	0,17	0,18	0,19	29
	0.0020	0.0024	0.0034	0.0044	0.0048	0.0055	0.0060	0.0065	0.0070	0.0075	95
M5	0,050	0,060	0,085	0,11	0,12	0,14	0,15	0,17	0,18	0,19	24
	0.0020	0.0024	0.0034	0.0044	0.0048	0.0055	0.0060	0.0065	0.0070	0.0075	80
K1	0,12	0,14	0,18	0,22	0,26	0,28	0,30	0,34	0,34	0,36	75
	0.0048	0.0055	0.0070	0.0085	0.010	0.011	0.012	0.013	0.013	0.014	245
K2	0,11	0,13	0,16	0,20	0,24	0,26	0,28	0,30	0,32	0,34	65
	0.0044	0.0050	0.0065	0.0080	0.0095	0.010	0.011	0.012	0.013	0.013	215
K3	0,11	0,13	0,16	0,20	0,24	0,26	0,28	0,30	0,32	0,34	55
	0.0044	0.0050	0.0065	0.0080	0.0095	0.010	0.011	0.012	0.013	0.013	180
K4	0,11	0,13	0,16	0,20	0,24	0,26	0,28	0,30	0,32	0,34	50
	0.0044	0.0050	0.0065	0.0080	0.0095	0.010	0.011	0.012	0.013	0.013	165
K5	0,10	0,11	0,15	0,18	0,20	0,24	0,25	0,28	0,28	0,30	31
	0.0040	0.0044	0.0060	0.0070	0.0080	0.0095	0.010	0.011	0.011	0.012	100
N1	0,15	0,17	0,22	0,25	0,28	0,32	0,34	0,36	0,38	0,40	205
	0.0060	0.0065	0.0085	0.010	0.011	0.013	0.013	0.014	0.015	0.016	670
N2	0,15	0,17	0,22	0,25	0,28	0,32	0,34	0,36	0,38	0,40	135
	0.0060	0.0065	0.0085	0.010	0.011	0.013	0.013	0.014	0.015	0.016	445
N3	0,15	0,17	0,22	0,25	0,28	0,32	0,34	0,36	0,38	0,40	90
	0.0060	0.0065	0.0085	0.010	0.011	0.013	0.013	0.014	0.015	0.016	295
N11	0,15	0,17	0,22	0,25	0,28	0,32	0,34	0,36	0,38	0,40	165
	0.0060	0.0065	0.0085	0.010	0.011	0.013	0.013	0.014	0.015	0.016	540
H3	0,048	0,055	0,075	0,090	0,10	0,12	0,13	0,14	0,14	0,15	27
	0.0019	0.0022	0.0030	0.0036	0.0040	0.0048	0.0050	0.0055	0.0055	0.0060	90
H5	0,075	0,085	0,11	0,14	0,16	0,18	0,19	0,20	0,22	0,22	50
	0.0030	0.0034	0.0044	0.0055	0.0065	0.0070	0.0075	0.0080	0.0085	0.0085	165
H7	0,048	0,055	0,075	0,090	0,10	0,12	0,13	0,14	0,14	0,15	27
	0.0019	0.0022	0.0030	0.0036	0.0040	0.0048	0.0050	0.0055	0.0055	0.0060	90
H8	0,055	0,065	0,085	0,10	0,12	0,14	0,15	0,16	0,17	0,17	50
	0.0022	0.0026	0.0034	0.0040	0.0048	0.0055	0.0060	0.0065	0.0065	0.0065	165
H11	0,075	0,085	0,11	0,14	0,16	0,18	0,19	0,20	0,22	0,22	65
	0.0030	0.0034	0.0044	0.0055	0.0065	0.0070	0.0075	0.0080	0.0085	0.0085	215
H12	0,055	0,065	0,085	0,10	0,12	0,14	0,15	0,16	0,17	0,17	30
	0.0022	0.0026	0.0034	0.0040	0.0048	0.0055	0.0060	0.0065	0.0065	0.0065	100

SMG = Gruppo materiale Seco

f = mm/giro

 v_c = m/min

Tutti i parametri di taglio sono valori di partenza

Quando si esegue la foratura su acciaio inossidabile con 8xD e 12xD, potrebbe essere necessaria un'operazione di pre-foratura

SD1112A – Ø 3-20 mm / 0.118-0.787 pollici

SMG	f										v _c	
	Ø 3,00 Ø 0.118	Ø 4,00 Ø 0.157	Ø 6,00 Ø 0.236	Ø 8,00 Ø 0.315	Ø 10,00 Ø 0.394	Ø 12,00 Ø 0.472	Ø 14,00 Ø 0.551	Ø 16,00 Ø 0.630	Ø 18,00 Ø 0.709	Ø 20,00 Ø 0.787		
Introduzione	P1	0,12	0,14	0,18	0,22	0,25	0,28	0,30	0,32	0,34	0,36	100
		0.0048	0.0055	0.0070	0.0085	0.010	0.011	0.012	0.013	0.013	0.014	330
	P2	0,12	0,14	0,18	0,22	0,26	0,28	0,32	0,34	0,36	0,36	100
		0.0048	0.0055	0.0070	0.0085	0.010	0.011	0.013	0.013	0.014	0.014	330
	P3	0,11	0,13	0,17	0,20	0,24	0,28	0,30	0,32	0,34	0,34	85
		0.0044	0.0050	0.0065	0.0080	0.0095	0.011	0.012	0.013	0.013	0.013	280
P4	0,11	0,13	0,17	0,20	0,24	0,26	0,28	0,30	0,32	0,34	75	
	0.0044	0.0050	0.0065	0.0080	0.0095	0.010	0.011	0.012	0.013	0.013	245	
P5	0,11	0,13	0,16	0,20	0,24	0,26	0,28	0,30	0,32	0,34	70	
	0.0044	0.0050	0.0065	0.0080	0.0095	0.010	0.011	0.012	0.013	0.013	230	
P6	0,11	0,12	0,16	0,20	0,24	0,26	0,28	0,30	0,32	0,34	80	
	0.0044	0.0048	0.0065	0.0080	0.0095	0.010	0.011	0.012	0.013	0.013	260	
P7	0,11	0,12	0,16	0,20	0,24	0,26	0,28	0,30	0,32	0,34	75	
	0.0044	0.0048	0.0065	0.0080	0.0095	0.010	0.011	0.012	0.013	0.013	245	
P8	0,11	0,13	0,17	0,20	0,24	0,28	0,30	0,32	0,34	0,34	70	
	0.0044	0.0050	0.0065	0.0080	0.0095	0.011	0.012	0.013	0.013	0.013	230	
P11	0,11	0,12	0,16	0,20	0,24	0,26	0,28	0,30	0,32	0,34	50	
	0.0044	0.0048	0.0065	0.0080	0.0095	0.010	0.011	0.012	0.013	0.013	165	
P12	0,075	0,085	0,11	0,14	0,16	0,18	0,19	0,20	0,22	0,22	36	
	0.0030	0.0034	0.0044	0.0055	0.0065	0.0070	0.0075	0.0080	0.0085	0.0085	120	
M1	0,080	0,095	0,13	0,17	0,20	0,22	0,24	0,26	0,28	0,30	55	
	0.0032	0.0038	0.0050	0.0065	0.0080	0.0085	0.0095	0.010	0.011	0.012	180	
M2	0,070	0,085	0,12	0,15	0,18	0,20	0,22	0,24	0,25	0,26	43	
	0.0028	0.0034	0.0048	0.0060	0.0070	0.0080	0.0085	0.0095	0.010	0.010	140	
M3	0,055	0,070	0,095	0,12	0,14	0,16	0,18	0,19	0,20	0,22	33	
	0.0022	0.0028	0.0038	0.0048	0.0055	0.0065	0.0070	0.0075	0.0080	0.0085	110	
M4	0,050	0,060	0,085	0,11	0,12	0,14	0,15	0,17	0,18	0,19	25	
	0.0020	0.0024	0.0034	0.0044	0.0048	0.0055	0.0060	0.0065	0.0070	0.0075	80	
M5	0,050	0,060	0,085	0,11	0,12	0,14	0,15	0,17	0,18	0,19	21	
	0.0020	0.0024	0.0034	0.0044	0.0048	0.0055	0.0060	0.0065	0.0070	0.0075	70	
K1	0,12	0,14	0,18	0,22	0,26	0,28	0,30	0,34	0,34	0,36	65	
	0.0048	0.0055	0.0070	0.0085	0.010	0.011	0.012	0.013	0.013	0.014	215	
K2	0,11	0,13	0,16	0,20	0,24	0,26	0,28	0,30	0,32	0,34	55	
	0.0044	0.0050	0.0065	0.0080	0.0095	0.010	0.011	0.012	0.013	0.013	180	
K3	0,11	0,13	0,16	0,20	0,24	0,26	0,28	0,30	0,32	0,34	47	
	0.0044	0.0050	0.0065	0.0080	0.0095	0.010	0.011	0.012	0.013	0.013	155	
K4	0,11	0,13	0,16	0,20	0,24	0,26	0,28	0,30	0,32	0,34	45	
	0.0044	0.0050	0.0065	0.0080	0.0095	0.010	0.011	0.012	0.013	0.013	150	
K5	0,10	0,11	0,15	0,18	0,20	0,24	0,25	0,28	0,28	0,30	27	
	0.0040	0.0044	0.0060	0.0070	0.0080	0.0095	0.010	0.011	0.011	0.012	90	
N1	0,15	0,17	0,22	0,25	0,28	0,32	0,34	0,36	0,38	0,40	180	
	0.0060	0.0065	0.0085	0.010	0.011	0.013	0.013	0.014	0.015	0.016	590	
N2	0,15	0,17	0,22	0,25	0,28	0,32	0,34	0,36	0,38	0,40	115	
	0.0060	0.0065	0.0085	0.010	0.011	0.013	0.013	0.014	0.015	0.016	375	
N3	0,15	0,17	0,22	0,25	0,28	0,32	0,34	0,36	0,38	0,40	75	
	0.0060	0.0065	0.0085	0.010	0.011	0.013	0.013	0.014	0.015	0.016	245	
N11	0,15	0,17	0,22	0,25	0,28	0,32	0,34	0,36	0,38	0,40	145	
	0.0060	0.0065	0.0085	0.010	0.011	0.013	0.013	0.014	0.015	0.016	475	
H3	0,048	0,055	0,075	0,090	0,10	0,12	0,13	0,14	0,14	0,15	23	
	0.0019	0.0022	0.0030	0.0036	0.0040	0.0048	0.0050	0.0055	0.0055	0.0060	75	
H5	0,075	0,085	0,11	0,14	0,16	0,18	0,19	0,20	0,22	0,22	43	
	0.0030	0.0034	0.0044	0.0055	0.0065	0.0070	0.0075	0.0080	0.0085	0.0085	140	
H7	0,048	0,055	0,075	0,090	0,10	0,12	0,13	0,14	0,14	0,15	23	
	0.0019	0.0022	0.0030	0.0036	0.0040	0.0048	0.0050	0.0055	0.0055	0.0060	75	
H8	0,055	0,065	0,085	0,10	0,12	0,14	0,15	0,16	0,17	0,17	43	
	0.0022	0.0026	0.0034	0.0040	0.0048	0.0055	0.0060	0.0065	0.0065	0.0065	140	
H11	0,075	0,085	0,11	0,14	0,16	0,18	0,19	0,20	0,22	0,22	55	
	0.0030	0.0034	0.0044	0.0055	0.0065	0.0070	0.0075	0.0080	0.0085	0.0085	180	
H12	0,055	0,065	0,085	0,10	0,12	0,14	0,15	0,16	0,17	0,17	26	
	0.0022	0.0026	0.0034	0.0040	0.0048	0.0055	0.0060	0.0065	0.0065	0.0065	85	

SMG = Gruppo materiale Seco

f = mm/giro

v_c = m/min

Tutti i parametri di taglio sono valori di partenza

Quando si esegue la foratura su acciaio inossidabile con 8xD e 12xD, potrebbe essere necessaria un'operazione di pre-foratura

SMG		f						v _c
		Ø 2,00 Ø 0.079	Ø 3,00 Ø 0.118	Ø 4,00 Ø 0.157	Ø 5,00 Ø 0.197	Ø 6,00 Ø 0.236	Ø 8,00 Ø 0.315	
P1	P	0,14	0,17	0,20	0,24	0,26	0,32	185
	P	0.0055	0.0065	0.0080	0.0095	0.010	0.013	610
P2	P	0,14	0,17	0,20	0,24	0,26	0,32	180
	P	0.0055	0.0065	0.0080	0.0095	0.010	0.013	590
P3	P	0,14	0,16	0,19	0,22	0,25	0,32	155
	P	0.0055	0.0065	0.0075	0.0085	0.010	0.013	510
P4	P	0,10	0,13	0,15	0,17	0,19	0,24	210
	P	0.0040	0.0050	0.0060	0.0065	0.0075	0.0095	690
P5	P	0,10	0,12	0,14	0,17	0,19	0,22	205
	P	0.0040	0.0048	0.0055	0.0065	0.0075	0.0085	670
P6	P	0,10	0,12	0,14	0,16	0,19	0,22	230
	P	0.0040	0.0048	0.0055	0.0065	0.0075	0.0085	750
P7	P	0,10	0,12	0,14	0,16	0,19	0,22	215
	P	0.0040	0.0048	0.0055	0.0065	0.0075	0.0085	710
P8	P	0,11	0,13	0,15	0,17	0,19	0,24	200
	P	0.0044	0.0050	0.0060	0.0065	0.0075	0.0095	660
P11	P	0,060	0,075	0,085	0,10	0,11	0,14	105
	P	0.0024	0.0030	0.0034	0.0040	0.0044	0.0055	345
P12	P	0,060	0,075	0,085	0,10	0,11	0,14	75
	P	0.0024	0.0030	0.0034	0.0040	0.0044	0.0055	245
M1	MS	0,075	0,095	0,11	0,13	0,15	0,19	110
	MS	0.0030	0.0038	0.0044	0.0050	0.0060	0.0075	360
M2	MS	0,065	0,085	0,10	0,12	0,14	0,17	90
	MS	0.0026	0.0034	0.0040	0.0048	0.0055	0.0065	295
M3	MS	0,095	0,11	0,13	0,15	0,17	0,20	45
	MS	0.0038	0.0044	0.0050	0.0060	0.0065	0.0080	150
M4	MS	0,048	0,060	0,070	0,085	0,095	0,12	50
	MS	0.0019	0.0024	0.0028	0.0034	0.0038	0.0048	165
M5	MS	0,048	0,060	0,070	0,085	0,095	0,12	42
	MS	0.0019	0.0024	0.0028	0.0034	0.0038	0.0048	140
K1	P	0,15	0,18	0,22	0,25	0,28	0,36	175
	P	0.0060	0.0070	0.0085	0.010	0.011	0.014	570
K2	P	0,14	0,17	0,20	0,22	0,26	0,32	150
	P	0.0055	0.0065	0.0080	0.0085	0.010	0.013	490
K3	P	0,14	0,17	0,20	0,22	0,26	0,32	125
	P	0.0055	0.0065	0.0080	0.0085	0.010	0.013	410
K4	P	0,14	0,17	0,20	0,22	0,26	0,32	120
	P	0.0055	0.0065	0.0080	0.0085	0.010	0.013	395
K5	P	0,12	0,15	0,18	0,20	0,24	0,28	70
	P	0.0048	0.0060	0.0070	0.0080	0.0095	0.011	230
N1	N	0,13	0,16	0,19	0,22	0,26	0,32	350
	N	0.0050	0.0065	0.0075	0.0085	0.010	0.013	1150
N2	MS	0,13	0,16	0,19	0,22	0,26	0,32	225
	MS	0.0050	0.0065	0.0075	0.0085	0.010	0.013	740
N3	MS	0,13	0,16	0,19	0,22	0,26	0,32	150
	MS	0.0050	0.0065	0.0075	0.0085	0.010	0.013	490
N11	MS	0,13	0,16	0,19	0,22	0,26	0,32	285
	MS	0.0050	0.0065	0.0075	0.0085	0.010	0.013	940
S1	MS	0,040	0,048	0,055	0,065	0,075	0,095	39
	MS	0.0016	0.0019	0.0022	0.0026	0.0030	0.0038	130
S2	MS	0,040	0,048	0,055	0,065	0,075	0,095	28
	MS	0.0016	0.0019	0.0022	0.0026	0.0030	0.0038	90
S3	MS	0,040	0,048	0,055	0,065	0,075	0,095	28
	MS	0.0016	0.0019	0.0022	0.0026	0.0030	0.0038	90
S11	MS	0,070	0,085	0,095	0,11	0,12	0,14	70
	MS	0.0028	0.0034	0.0038	0.0044	0.0048	0.0055	230
S12	MS	0,070	0,085	0,095	0,11	0,12	0,14	55
	MS	0.0028	0.0034	0.0038	0.0044	0.0048	0.0055	180
S13	MS	0,065	0,075	0,085	0,095	0,10	0,12	43
	MS	0.0026	0.0030	0.0034	0.0038	0.0040	0.0048	140
H3	P	0,055	0,070	0,080	0,090	0,10	0,12	28
	P	0.0022	0.0028	0.0032	0.0036	0.0040	0.0048	90
H5	P	0,085	0,10	0,12	0,13	0,15	0,18	55
	P	0.0034	0.0040	0.0048	0.0050	0.0060	0.0070	180
H7	P	0,055	0,070	0,080	0,090	0,10	0,12	28
	P	0.0022	0.0028	0.0032	0.0036	0.0040	0.0048	90
H8	P	0,065	0,080	0,090	0,10	0,12	0,14	55
	P	0.0026	0.0032	0.0036	0.0040	0.0048	0.0055	180
H11	P	0,085	0,10	0,12	0,13	0,15	0,18	65
	P	0.0034	0.0040	0.0048	0.0050	0.0060	0.0070	215
H12	P	0,065	0,080	0,090	0,10	0,12	0,14	80
	P	0.0026	0.0032	0.0036	0.0040	0.0048	0.0055	260
H21	P	0,065	0,080	0,090	0,10	0,12	0,14	55
	P	0.0026	0.0032	0.0036	0.0040	0.0048	0.0055	180

SMG = Gruppo materiale Seco

f = mm/giro

v_c = m/min

Tutti i parametri di taglio sono valori di partenza

SMG		f						V _c
		Ø 10,00 Ø 0.394	Ø 12,00 Ø 0.472	Ø 14,00 Ø 0.551	Ø 16,00 Ø 0.630	Ø 18,00 Ø 0.709	Ø 20,00 Ø 0.787	
Introduzione	P1	P	0,38	0,44	0,48	0,50	0,55	185
		P	0,015	0,017	0,019	0,020	0,022	610
	P2	P	0,38	0,44	0,48	0,50	0,55	180
		P	0,015	0,017	0,019	0,020	0,022	590
	P3	P	0,36	0,42	0,46	0,50	0,50	155
		P	0,014	0,017	0,018	0,020	0,020	510
P4	P	0,28	0,30	0,34	0,36	0,38	210	
	P	0,011	0,012	0,013	0,014	0,015	690	
P5	P	0,26	0,30	0,32	0,34	0,36	205	
	P	0,010	0,012	0,013	0,013	0,014	670	
P6	P	0,26	0,30	0,32	0,34	0,36	230	
	P	0,010	0,012	0,013	0,013	0,014	750	
P7	P	0,26	0,30	0,32	0,34	0,36	215	
	P	0,010	0,012	0,013	0,013	0,014	710	
P8	P	0,28	0,32	0,34	0,36	0,38	200	
	P	0,011	0,013	0,013	0,014	0,015	660	
P11	P	0,16	0,18	0,20	0,22	0,24	105	
	P	0,0065	0,0070	0,0080	0,0085	0,0095	345	
P12	P	0,16	0,18	0,20	0,22	0,24	75	
	P	0,0065	0,0070	0,0080	0,0085	0,0095	245	
M1	MS	0,22	0,25	0,28	0,30	0,30	110	
	MS	0,0085	0,010	0,011	0,012	0,012	360	
M2	MS	0,20	0,22	0,25	0,26	0,28	90	
	MS	0,0080	0,0085	0,010	0,010	0,011	295	
M3	MS	0,24	0,26	0,28	0,30	0,32	45	
	MS	0,0095	0,010	0,011	0,012	0,013	150	
M4	MS	0,14	0,16	0,17	0,19	0,20	50	
	MS	0,0055	0,0065	0,0065	0,0075	0,0080	165	
M5	MS	0,14	0,16	0,17	0,19	0,20	42	
	MS	0,0055	0,0065	0,0065	0,0075	0,0080	140	
K1	P	0,42	0,48	0,50	0,55	0,60	175	
	P	0,017	0,019	0,020	0,022	0,024	570	
K2	P	0,38	0,42	0,48	0,50	0,55	150	
	P	0,015	0,017	0,019	0,020	0,022	490	
K3	P	0,38	0,42	0,48	0,50	0,55	125	
	P	0,015	0,017	0,019	0,020	0,022	410	
K4	P	0,38	0,42	0,48	0,50	0,55	120	
	P	0,015	0,017	0,019	0,020	0,022	395	
K5	P	0,34	0,38	0,42	0,46	0,48	70	
	P	0,013	0,015	0,017	0,018	0,019	230	
N1	N	0,38	0,42	0,46	0,50	0,55	350	
	N	0,015	0,017	0,018	0,020	0,022	1150	
N2	MS	0,38	0,42	0,46	0,50	0,55	225	
	MS	0,015	0,017	0,018	0,020	0,022	740	
N3	MS	0,38	0,42	0,46	0,50	0,55	150	
	MS	0,015	0,017	0,018	0,020	0,022	490	
N11	MS	0,38	0,42	0,46	0,50	0,55	285	
	MS	0,015	0,017	0,018	0,020	0,022	940	
S1	MS	0,11	0,13	0,15	0,16	0,17	39	
	MS	0,0044	0,0050	0,0060	0,0065	0,0065	130	
S2	MS	0,11	0,13	0,15	0,16	0,17	28	
	MS	0,0044	0,0050	0,0060	0,0065	0,0065	90	
S3	MS	0,11	0,13	0,15	0,16	0,17	28	
	MS	0,0044	0,0050	0,0060	0,0065	0,0065	90	
S11	MS	0,17	0,19	0,22	0,24	0,25	70	
	MS	0,0065	0,0075	0,0085	0,0095	0,010	230	
S12	MS	0,17	0,19	0,22	0,24	0,25	55	
	MS	0,0065	0,0075	0,0085	0,0095	0,010	180	
S13	MS	0,15	0,17	0,19	0,20	0,22	43	
	MS	0,0060	0,0065	0,0075	0,0080	0,0085	140	
H3	P	0,14	0,16	0,18	0,19	0,20	28	
	P	0,0055	0,0065	0,0070	0,0075	0,0080	90	
H5	P	0,22	0,24	0,26	0,28	0,30	55	
	P	0,0085	0,0095	0,010	0,011	0,012	180	
H7	P	0,14	0,16	0,18	0,19	0,20	28	
	P	0,0055	0,0065	0,0070	0,0075	0,0080	90	
H8	P	0,16	0,19	0,20	0,22	0,24	55	
	P	0,0065	0,0075	0,0080	0,0085	0,0095	180	
H11	P	0,22	0,24	0,26	0,28	0,30	65	
	P	0,0085	0,0095	0,010	0,011	0,012	215	
H12	P	0,16	0,19	0,20	0,22	0,24	80	
	P	0,0065	0,0075	0,0080	0,0085	0,0095	260	
H21	P	0,16	0,19	0,20	0,22	0,24	55	
	P	0,0065	0,0075	0,0080	0,0085	0,0095	180	

SMG = Gruppo materiale Seco
f = mm/giro
v_c = m/min
Tutti i parametri di taglio sono valori di partenza

SMG		f						v _c
		Ø 2,00 Ø 0.079	Ø 3,00 Ø 0.118	Ø 4,00 Ø 0.157	Ø 5,00 Ø 0.197	Ø 6,00 Ø 0.236	Ø 8,00 Ø 0.315	
P1	P	0,14	0,17	0,20	0,24	0,26	0,32	170
	P	0.0055	0.0065	0.0080	0.0095	0.010	0.013	560
P2	P	0,14	0,17	0,20	0,24	0,26	0,32	165
	P	0.0055	0.0065	0.0080	0.0095	0.010	0.013	540
P3	P	0,14	0,16	0,19	0,22	0,25	0,32	140
	P	0.0055	0.0065	0.0075	0.0085	0.010	0.013	460
P4	P	0,10	0,13	0,15	0,17	0,19	0,24	195
	P	0.0040	0.0050	0.0060	0.0065	0.0075	0.0095	640
P5	P	0,10	0,12	0,14	0,17	0,19	0,22	185
	P	0.0040	0.0048	0.0055	0.0065	0.0075	0.0085	610
P6	P	0,10	0,12	0,14	0,16	0,19	0,22	210
	P	0.0040	0.0048	0.0055	0.0065	0.0075	0.0085	690
P7	P	0,10	0,12	0,14	0,16	0,19	0,22	200
	P	0.0040	0.0048	0.0055	0.0065	0.0075	0.0085	660
P8	P	0,11	0,13	0,15	0,17	0,19	0,24	185
	P	0.0044	0.0050	0.0060	0.0065	0.0075	0.0095	610
P11	P	0,060	0,075	0,085	0,10	0,11	0,14	95
	P	0.0024	0.0030	0.0034	0.0040	0.0044	0.0055	310
P12	P	0,060	0,075	0,085	0,10	0,11	0,14	65
	P	0.0024	0.0030	0.0034	0.0040	0.0044	0.0055	215
M1	MS	0,075	0,095	0,11	0,13	0,15	0,19	110
	MS	0.0030	0.0038	0.0044	0.0050	0.0060	0.0075	360
M2	MS	0,065	0,085	0,10	0,12	0,14	0,17	90
	MS	0.0026	0.0034	0.0040	0.0048	0.0055	0.0065	295
M3	MS	0,095	0,11	0,13	0,15	0,17	0,20	45
	MS	0.0038	0.0044	0.0050	0.0060	0.0065	0.0080	150
M4	MS	0,048	0,060	0,070	0,085	0,095	0,12	50
	MS	0.0019	0.0024	0.0028	0.0034	0.0038	0.0048	165
M5	MS	0,048	0,060	0,070	0,085	0,095	0,12	42
	MS	0.0019	0.0024	0.0028	0.0034	0.0038	0.0048	140
K1	P	0,15	0,18	0,22	0,25	0,28	0,36	160
	P	0.0060	0.0070	0.0085	0.010	0.011	0.014	520
K2	P	0,14	0,17	0,20	0,22	0,26	0,32	135
	P	0.0055	0.0065	0.0080	0.0085	0.010	0.013	445
K3	P	0,14	0,17	0,20	0,22	0,26	0,32	115
	P	0.0055	0.0065	0.0080	0.0085	0.010	0.013	375
K4	P	0,14	0,17	0,20	0,22	0,26	0,32	110
	P	0.0055	0.0065	0.0080	0.0085	0.010	0.013	360
K5	P	0,12	0,15	0,18	0,20	0,24	0,28	65
	P	0.0048	0.0060	0.0070	0.0080	0.0095	0.011	215
N1	N	0,13	0,16	0,19	0,22	0,26	0,32	350
	N	0.0050	0.0065	0.0075	0.0085	0.010	0.013	1150
N2	MS	0,13	0,16	0,19	0,22	0,26	0,32	225
	MS	0.0050	0.0065	0.0075	0.0085	0.010	0.013	740
N3	MS	0,13	0,16	0,19	0,22	0,26	0,32	150
	MS	0.0050	0.0065	0.0075	0.0085	0.010	0.013	490
N11	MS	0,13	0,16	0,19	0,22	0,26	0,32	285
	MS	0.0050	0.0065	0.0075	0.0085	0.010	0.013	940
S1	MS	0,040	0,048	0,055	0,065	0,075	0,095	39
	MS	0.0016	0.0019	0.0022	0.0026	0.0030	0.0038	130
S2	MS	0,040	0,048	0,055	0,065	0,075	0,095	28
	MS	0.0016	0.0019	0.0022	0.0026	0.0030	0.0038	90
S3	MS	0,040	0,048	0,055	0,065	0,075	0,095	28
	MS	0.0016	0.0019	0.0022	0.0026	0.0030	0.0038	90
S11	MS	0,070	0,085	0,095	0,11	0,12	0,14	70
	MS	0.0028	0.0034	0.0038	0.0044	0.0048	0.0055	230
S12	MS	0,070	0,085	0,095	0,11	0,12	0,14	55
	MS	0.0028	0.0034	0.0038	0.0044	0.0048	0.0055	180
S13	MS	0,065	0,075	0,085	0,095	0,10	0,12	43
	MS	0.0026	0.0030	0.0034	0.0038	0.0040	0.0048	140
H3	P	0,055	0,070	0,080	0,090	0,10	0,12	26
	P	0.0022	0.0028	0.0032	0.0036	0.0040	0.0048	85
H5	P	0,085	0,10	0,12	0,13	0,15	0,18	48
	P	0.0034	0.0040	0.0048	0.0050	0.0060	0.0070	155
H7	P	0,055	0,070	0,080	0,090	0,10	0,12	26
	P	0.0022	0.0028	0.0032	0.0036	0.0040	0.0048	85
H8	P	0,065	0,080	0,090	0,10	0,12	0,14	48
	P	0.0026	0.0032	0.0036	0.0040	0.0048	0.0055	155
H11	P	0,085	0,10	0,12	0,13	0,15	0,18	60
	P	0.0034	0.0040	0.0048	0.0050	0.0060	0.0070	195
H12	P	0,065	0,080	0,090	0,10	0,12	0,14	70
	P	0.0026	0.0032	0.0036	0.0040	0.0048	0.0055	230
H21	P	0,065	0,080	0,090	0,10	0,12	0,14	48
	P	0.0026	0.0032	0.0036	0.0040	0.0048	0.0055	155

SMG = Gruppo materiale Seco
f = mm/giro
v_c = m/min
Tutti i parametri di taglio sono valori di partenza

Introduzione

Foratura

Alesatura

Barenatura

Allegato

Foratura

Seco Universal™ – Parametri di taglio



SD205A – Ø 10-20 mm / 0.394-0.787 pollici

SMG		f						V _c
		Ø 10,00 Ø 0.394	Ø 12,00 Ø 0.472	Ø 14,00 Ø 0.551	Ø 16,00 Ø 0.630	Ø 18,00 Ø 0.709	Ø 20,00 Ø 0.787	
P1	P	0,38	0,44	0,48	0,50	0,55	0,55	170
	P	0,015	0,017	0,019	0,020	0,022	0,022	560
P2	P	0,38	0,44	0,48	0,50	0,55	0,60	165
	P	0,015	0,017	0,019	0,020	0,022	0,024	540
P3	P	0,36	0,42	0,46	0,50	0,50	0,55	140
	P	0,014	0,017	0,018	0,020	0,020	0,022	460
P4	P	0,28	0,30	0,34	0,36	0,38	0,40	195
	P	0,011	0,012	0,013	0,014	0,015	0,016	640
P5	P	0,26	0,30	0,32	0,34	0,36	0,38	185
	P	0,010	0,012	0,013	0,013	0,014	0,015	610
P6	P	0,26	0,30	0,32	0,34	0,36	0,38	210
	P	0,010	0,012	0,013	0,013	0,014	0,015	690
P7	P	0,26	0,30	0,32	0,34	0,36	0,38	200
	P	0,010	0,012	0,013	0,013	0,014	0,015	660
P8	P	0,28	0,32	0,34	0,36	0,38	0,40	185
	P	0,011	0,013	0,013	0,014	0,015	0,016	610
P11	P	0,16	0,18	0,20	0,22	0,24	0,24	95
	P	0,0065	0,0070	0,0080	0,0085	0,0095	0,0095	310
M1	MS	0,22	0,25	0,28	0,30	0,30	0,32	110
	MS	0,0085	0,010	0,011	0,012	0,012	0,013	360
M2	MS	0,20	0,22	0,25	0,26	0,28	0,30	90
	MS	0,0080	0,0085	0,010	0,010	0,011	0,012	295
M3	MS	0,24	0,26	0,28	0,30	0,32	0,34	45
	MS	0,0095	0,010	0,011	0,012	0,013	0,013	150
M4	MS	0,14	0,16	0,17	0,19	0,20	0,20	50
	MS	0,0055	0,0065	0,0065	0,0075	0,0080	0,0080	165
M5	MS	0,14	0,16	0,17	0,19	0,20	0,20	42
	MS	0,0055	0,0065	0,0065	0,0075	0,0080	0,0080	140
K1	P	0,42	0,48	0,50	0,55	0,60	0,65	160
	P	0,017	0,019	0,020	0,022	0,024	0,026	520
K2	P	0,38	0,42	0,48	0,50	0,55	0,55	135
	P	0,015	0,017	0,019	0,020	0,022	0,022	445
K3	P	0,38	0,42	0,48	0,50	0,55	0,55	115
	P	0,015	0,017	0,019	0,020	0,022	0,022	375
K4	P	0,38	0,42	0,48	0,50	0,55	0,55	110
	P	0,015	0,017	0,019	0,020	0,022	0,022	360
K5	P	0,34	0,38	0,42	0,46	0,48	0,50	65
	P	0,013	0,015	0,017	0,018	0,019	0,020	215
N1	N	0,38	0,42	0,46	0,50	0,55	0,55	350
	N	0,015	0,017	0,018	0,020	0,022	0,022	1150
N2	MS	0,38	0,42	0,46	0,50	0,55	0,55	225
	MS	0,015	0,017	0,018	0,020	0,022	0,022	740
N3	MS	0,38	0,42	0,46	0,50	0,55	0,55	150
	MS	0,015	0,017	0,018	0,020	0,022	0,022	490
N11	MS	0,38	0,42	0,46	0,50	0,55	0,55	285
	MS	0,015	0,017	0,018	0,020	0,022	0,022	940
S1	MS	0,11	0,13	0,15	0,16	0,17	0,19	39
	MS	0,0044	0,0050	0,0060	0,0065	0,0065	0,0075	130
S2	MS	0,11	0,13	0,15	0,16	0,17	0,19	28
	MS	0,0044	0,0050	0,0060	0,0065	0,0065	0,0075	90
S3	MS	0,11	0,13	0,15	0,16	0,17	0,19	28
	MS	0,0044	0,0050	0,0060	0,0065	0,0065	0,0075	90
S11	MS	0,17	0,19	0,22	0,24	0,25	0,26	70
	MS	0,0065	0,0075	0,0085	0,0095	0,010	0,010	230
S12	MS	0,17	0,19	0,22	0,24	0,25	0,26	55
	MS	0,0065	0,0075	0,0085	0,0095	0,010	0,010	180
S13	MS	0,15	0,17	0,19	0,20	0,22	0,22	43
	MS	0,0060	0,0065	0,0075	0,0080	0,0085	0,0085	140
H3	P	0,14	0,16	0,18	0,19	0,20	0,20	26
	P	0,0055	0,0065	0,0070	0,0075	0,0080	0,0080	85
H5	P	0,22	0,24	0,26	0,28	0,30	0,32	48
	P	0,0085	0,0095	0,010	0,011	0,012	0,013	155
H7	P	0,14	0,16	0,18	0,19	0,20	0,20	26
	P	0,0055	0,0065	0,0070	0,0075	0,0080	0,0080	85
H8	P	0,16	0,19	0,20	0,22	0,24	0,24	48
	P	0,0065	0,0075	0,0080	0,0085	0,0095	0,0095	155
H11	P	0,22	0,24	0,26	0,28	0,30	0,32	60
	P	0,0085	0,0095	0,010	0,011	0,012	0,013	195
H12	P	0,16	0,19	0,20	0,22	0,24	0,24	70
	P	0,0065	0,0075	0,0080	0,0085	0,0095	0,0095	230
H21	P	0,16	0,19	0,20	0,22	0,24	0,24	48
	P	0,0065	0,0075	0,0080	0,0085	0,0095	0,0095	155

SMG = Gruppo materiale Seco

f = mm/giro

v_c = m/min

Tutti i parametri di taglio sono valori di partenza

SMG		f			V _c
		Ø 0,70 Ø 0.0276	Ø 1,00 Ø 0.0394	Ø 2,00 Ø 0.0787	
P1	P	0,080	0,090	0,11	140
	P	0,0032	0,0036	0,0044	460
P2	P	0,085	0,090	0,12	140
	P	0,0034	0,0036	0,0048	460
P3	P	0,080	0,085	0,11	120
	P	0,0032	0,0034	0,0044	395
P4	P	0,080	0,085	0,11	105
	P	0,0032	0,0034	0,0044	345
P5	P	0,075	0,085	0,11	100
	P	0,0030	0,0034	0,0044	330
P6	P	0,075	0,080	0,10	110
	P	0,0030	0,0032	0,0040	360
P7	P	0,075	0,080	0,10	105
	P	0,0030	0,0032	0,0040	345
P8	P	0,080	0,085	0,11	100
	P	0,0032	0,0034	0,0044	330
P11	P	0,075	0,080	0,10	105
	P	0,0030	0,0032	0,0040	345
P12	P	0,050	0,055	0,070	60
	P	0,0020	0,0022	0,0028	195
K1	P	0,085	0,090	0,12	100
	P	0,0034	0,0036	0,0048	330
K2	P	0,075	0,085	0,11	85
	P	0,0030	0,0034	0,0044	280
K3	P	0,075	0,085	0,11	75
	P	0,0030	0,0034	0,0044	245
K4	P	0,075	0,085	0,11	70
	P	0,0030	0,0034	0,0044	230
K5	P	0,070	0,075	0,095	42
	P	0,0028	0,0030	0,0038	140

SMG = Gruppo materiale Seco

f = mm/giro

V_c = m/min

Tutti i parametri di taglio sono valori di partenza

Introduzione

Foratura

Alesatura

Barenatura

Allegato

Foratura

Seco Universal™ – Parametri di taglio



SD206A – Ø 1-2 mm / 0.0394-0.0787 pollici

SMG		f			V _c
		Ø 1,00 Ø 0.0394	Ø 1,50 Ø 0.0591	Ø 2,00 Ø 0.0787	
P1	P	0,090	0,10	0,11	175
	P	0.0036	0.0040	0.0044	570
P2	P	0,090	0,10	0,12	170
	P	0.0036	0.0040	0.0048	560
P3	P	0,085	0,10	0,11	145
	P	0.0034	0.0040	0.0044	475
P4	P	0,085	0,095	0,11	130
	P	0.0034	0.0038	0.0044	425
P5	P	0,085	0,095	0,11	125
	P	0.0034	0.0038	0.0044	410
P6	P	0,080	0,095	0,10	140
	P	0.0032	0.0038	0.0040	460
P7	P	0,080	0,095	0,10	130
	P	0.0032	0.0038	0.0040	425
P8	P	0,085	0,10	0,11	125
	P	0.0034	0.0040	0.0044	410
P11	P	0,080	0,095	0,10	125
	P	0.0032	0.0038	0.0040	410
P12	P	0,055	0,065	0,070	75
	P	0.0022	0.0026	0.0028	245
M1	P	0,055	0,065	0,075	95
	P	0.0022	0.0026	0.0030	310
M2	P	0,050	0,060	0,070	75
	P	0.0020	0.0024	0.0028	245
M3	P	0,042	0,048	0,055	60
	P	0.0017	0.0019	0.0022	195
M4	P	0,036	0,042	0,048	43
	P	0.0014	0.0017	0.0019	140
M5	P	0,036	0,042	0,048	36
	P	0.0014	0.0017	0.0019	120
K1	P	0,095	0,11	0,12	115
	P	0.0038	0.0044	0.0048	375
K2	P	0,085	0,10	0,11	100
	P	0.0034	0.0040	0.0044	330
K3	P	0,085	0,10	0,11	85
	P	0.0034	0.0040	0.0044	280
K4	P	0,085	0,10	0,11	80
	P	0.0034	0.0040	0.0044	260
K5	P	0,075	0,090	0,10	47
	P	0.0030	0.0036	0.0040	155
N2	P	0,10	0,12	0,13	190
	P	0.0040	0.0048	0.0050	620
N3	P	0,10	0,12	0,13	125
	P	0.0040	0.0048	0.0050	410

SMG = Gruppo materiale Seco

f = mm/giro

V_c = m/min

Tutti i parametri di taglio sono valori di partenza

Introduzione

Foratura

Alesatura

Barenatura

Allegato

SMG		f										V _c
		Ø 3,00 Ø 0.118	Ø 5,00 Ø 0.197	Ø 6,00 Ø 0.236	Ø 8,00 Ø 0.315	Ø 10,00 Ø 0.394	Ø 12,00 Ø 0.472	Ø 14,00 Ø 0.551	Ø 16,00 Ø 0.630	Ø 18,00 Ø 0.709	Ø 20,00 Ø 0.787	
P1	P	0,17	0,24	0,26	0,32	0,38	0,44	0,48	0,50	0,55	0,55	155
	P	0.0065	0.0095	0.010	0.013	0.015	0.017	0.019	0.020	0.022	0.022	510
P2	P	0,17	0,24	0,26	0,32	0,38	0,44	0,48	0,50	0,55	0,60	155
	P	0.0065	0.0095	0.010	0.013	0.015	0.017	0.019	0.020	0.022	0.024	510
P3	P	0,16	0,22	0,25	0,32	0,36	0,42	0,46	0,50	0,50	0,55	130
	P	0.0065	0.0085	0.010	0.013	0.014	0.017	0.018	0.020	0.020	0.022	425
P4	P	0,13	0,17	0,19	0,24	0,28	0,30	0,34	0,36	0,38	0,40	180
	P	0.0050	0.0065	0.0075	0.0095	0.011	0.012	0.013	0.014	0.015	0.016	590
P5	P	0,12	0,17	0,19	0,22	0,26	0,30	0,32	0,34	0,36	0,38	175
	P	0.0048	0.0065	0.0075	0.0085	0.010	0.012	0.013	0.013	0.014	0.015	570
P6	P	0,12	0,16	0,19	0,22	0,26	0,30	0,32	0,34	0,36	0,38	195
	P	0.0048	0.0065	0.0075	0.0085	0.010	0.012	0.013	0.013	0.014	0.015	640
P7	P	0,12	0,16	0,19	0,22	0,26	0,30	0,32	0,34	0,36	0,38	185
	P	0.0048	0.0065	0.0075	0.0085	0.010	0.012	0.013	0.013	0.014	0.015	610
P8	P	0,13	0,17	0,19	0,24	0,28	0,32	0,34	0,36	0,38	0,40	175
	P	0.0050	0.0065	0.0075	0.0095	0.011	0.013	0.013	0.014	0.015	0.016	570
P11	P	0,075	0,10	0,11	0,14	0,16	0,18	0,20	0,22	0,24	0,24	90
	P	0.0030	0.0040	0.0044	0.0055	0.0065	0.0070	0.0080	0.0085	0.0095	0.0095	295
M1	P	0,095	0,13	0,15	0,19	0,22	0,25	0,28	0,30	0,30	0,32	50
	P	0.0038	0.0050	0.0060	0.0075	0.0085	0.010	0.011	0.012	0.012	0.013	165
M2	P	0,085	0,12	0,14	0,17	0,20	0,22	0,25	0,26	0,28	0,30	41
	P	0.0034	0.0048	0.0055	0.0065	0.0080	0.0085	0.010	0.010	0.011	0.012	135
M3	P	0,065	0,095	0,11	0,14	0,16	0,18	0,20	0,22	0,22	0,24	31
	P	0.0026	0.0038	0.0044	0.0055	0.0065	0.0070	0.0080	0.0085	0.0085	0.0095	100
M4	P	0,060	0,085	0,095	0,12	0,14	0,16	0,17	0,19	0,20	0,20	24
	P	0.0024	0.0034	0.0038	0.0048	0.0055	0.0065	0.0065	0.0075	0.0080	0.0080	80
M5	P	0,060	0,085	0,095	0,12	0,14	0,16	0,17	0,19	0,20	0,20	20
	P	0.0024	0.0034	0.0038	0.0048	0.0055	0.0065	0.0065	0.0075	0.0080	0.0080	65
K1	P	0,18	0,25	0,28	0,36	0,42	0,48	0,50	0,55	0,60	0,65	150
	P	0.0070	0.010	0.011	0.014	0.017	0.019	0.020	0.022	0.024	0.026	490
K2	P	0,17	0,22	0,26	0,32	0,38	0,42	0,48	0,50	0,55	0,55	130
	P	0.0065	0.0085	0.010	0.013	0.015	0.017	0.019	0.020	0.022	0.022	425
K3	P	0,17	0,22	0,26	0,32	0,38	0,42	0,48	0,50	0,55	0,55	110
	P	0.0065	0.0085	0.010	0.013	0.015	0.017	0.019	0.020	0.022	0.022	360
K4	P	0,17	0,22	0,26	0,32	0,38	0,42	0,48	0,50	0,55	0,55	105
	P	0.0065	0.0085	0.010	0.013	0.015	0.017	0.019	0.020	0.022	0.022	345
K5	P	0,15	0,20	0,24	0,28	0,34	0,38	0,42	0,46	0,48	0,50	60
	P	0.0060	0.0080	0.0095	0.011	0.013	0.015	0.017	0.018	0.019	0.020	195
H3	P	0,070	0,090	0,10	0,12	0,14	0,16	0,18	0,19	0,20	0,20	24
	P	0.0028	0.0036	0.0040	0.0048	0.0055	0.0065	0.0070	0.0075	0.0080	0.0080	80
H5	P	0,10	0,13	0,15	0,18	0,22	0,24	0,26	0,28	0,30	0,32	45
	P	0.0040	0.0050	0.0060	0.0070	0.0085	0.0095	0.010	0.011	0.012	0.013	150
H7	P	0,070	0,090	0,10	0,12	0,14	0,16	0,18	0,19	0,20	0,20	24
	P	0.0028	0.0036	0.0040	0.0048	0.0055	0.0065	0.0070	0.0075	0.0080	0.0080	80
H8	P	0,080	0,10	0,12	0,14	0,16	0,19	0,20	0,22	0,24	0,24	45
	P	0.0032	0.0040	0.0048	0.0055	0.0065	0.0075	0.0080	0.0085	0.0095	0.0095	150
H11	P	0,10	0,13	0,15	0,18	0,22	0,24	0,26	0,28	0,30	0,32	60
	P	0.0040	0.0050	0.0060	0.0070	0.0085	0.0095	0.010	0.011	0.012	0.013	195
H12	P	0,080	0,10	0,12	0,14	0,16	0,19	0,20	0,22	0,24	0,24	65
	P	0.0032	0.0040	0.0048	0.0055	0.0065	0.0075	0.0080	0.0085	0.0095	0.0095	215
H21	P	0,080	0,10	0,12	0,14	0,16	0,19	0,20	0,22	0,24	0,24	45
	P	0.0032	0.0040	0.0048	0.0055	0.0065	0.0075	0.0080	0.0085	0.0095	0.0095	150

SMG = Gruppo materiale Seco
f = mm/giro
v_c = m/min
Tutti i parametri di taglio sono valori di partenza

Introduzione

Foratura

Alesatura

Barenatura

Allegato

Foratura

Seco Universal™ – Parametri di taglio



SD216A – Ø 3-14 mm / 0.118-0.551 pollici

SMG		f								V _c
		Ø 3,00 Ø 0.118	Ø 5,00 Ø 0.197	Ø 6,00 Ø 0.236	Ø 8,00 Ø 0.315	Ø 10,00 Ø 0.394	Ø 12,00 Ø 0.472	Ø 14,00 Ø 0.551		
P1	P	0,13	0,18	0,20	0,25	0,30	0,32	0,36	125	
	P	0.0050	0.0070	0.0080	0.010	0.012	0.013	0.014	410	
P2	P	0,14	0,18	0,20	0,26	0,30	0,34	0,36	120	
	P	0.0055	0.0070	0.0080	0.010	0.012	0.013	0.014	395	
P3	P	0,13	0,17	0,20	0,24	0,28	0,32	0,34	105	
	P	0.0050	0.0065	0.0080	0.0095	0.011	0.013	0.013	345	
P4	P	0,13	0,17	0,19	0,24	0,28	0,30	0,34	90	
	P	0.0050	0.0065	0.0075	0.0095	0.011	0.012	0.013	295	
P5	P	0,12	0,17	0,19	0,24	0,28	0,30	0,34	85	
	P	0.0048	0.0065	0.0075	0.0095	0.011	0.012	0.013	280	
P6	P	0,12	0,17	0,19	0,24	0,26	0,30	0,32	95	
	P	0.0048	0.0065	0.0075	0.0095	0.010	0.012	0.013	310	
P7	P	0,12	0,17	0,19	0,24	0,26	0,30	0,32	90	
	P	0.0048	0.0065	0.0075	0.0095	0.010	0.012	0.013	295	
P8	P	0,13	0,17	0,20	0,24	0,28	0,32	0,34	85	
	P	0.0050	0.0065	0.0080	0.0095	0.011	0.013	0.013	280	
P11	P	0,12	0,17	0,19	0,24	0,26	0,30	0,32	90	
	P	0.0048	0.0065	0.0075	0.0095	0.010	0.012	0.013	295	
P12	P	0,085	0,11	0,13	0,16	0,18	0,20	0,22	55	
	P	0.0034	0.0044	0.0050	0.0065	0.0070	0.0080	0.0085	180	
M1	P	0,095	0,13	0,15	0,19	0,22	0,25	0,28	65	
	P	0.0038	0.0050	0.0060	0.0075	0.0085	0.010	0.011	215	
M2	P	0,085	0,12	0,14	0,17	0,20	0,22	0,25	55	
	P	0.0034	0.0048	0.0055	0.0065	0.0080	0.0085	0.010	180	
M3	P	0,070	0,095	0,11	0,14	0,16	0,18	0,20	41	
	P	0.0028	0.0038	0.0044	0.0055	0.0065	0.0070	0.0080	135	
M4	P	0,060	0,085	0,095	0,12	0,14	0,16	0,18	31	
	P	0.0024	0.0034	0.0038	0.0048	0.0055	0.0065	0.0070	100	
M5	P	0,060	0,085	0,095	0,12	0,14	0,16	0,18	25	
	P	0.0024	0.0034	0.0038	0.0048	0.0055	0.0065	0.0070	80	
K1	P	0,15	0,22	0,24	0,30	0,36	0,40	0,44	80	
	P	0.0060	0.0085	0.0095	0.012	0.014	0.016	0.017	260	
K2	P	0,14	0,19	0,22	0,28	0,32	0,36	0,40	70	
	P	0.0055	0.0075	0.0085	0.011	0.013	0.014	0.016	230	
K3	P	0,14	0,19	0,22	0,28	0,32	0,36	0,40	60	
	P	0.0055	0.0075	0.0085	0.011	0.013	0.014	0.016	195	
K4	P	0,14	0,19	0,22	0,28	0,32	0,36	0,40	55	
	P	0.0055	0.0075	0.0085	0.011	0.013	0.014	0.016	180	
K5	P	0,12	0,17	0,20	0,25	0,30	0,32	0,36	33	
	P	0.0048	0.0065	0.0080	0.010	0.012	0.013	0.014	110	
N2	P	0,16	0,22	0,26	0,32	0,38	0,42	0,46	135	
	P	0.0065	0.0085	0.010	0.013	0.015	0.017	0.018	445	
N3	P	0,16	0,22	0,26	0,32	0,38	0,42	0,46	90	
	P	0.0065	0.0085	0.010	0.013	0.015	0.017	0.018	295	
H3	P	0,055	0,075	0,085	0,10	0,12	0,14	0,15	22	
	P	0.0022	0.0030	0.0034	0.0040	0.0048	0.0055	0.0060	70	
H5	P	0,085	0,11	0,13	0,16	0,18	0,20	0,22	40	
	P	0.0034	0.0044	0.0050	0.0065	0.0070	0.0080	0.0085	130	
H7	P	0,055	0,075	0,085	0,10	0,12	0,14	0,15	22	
	P	0.0022	0.0030	0.0034	0.0040	0.0048	0.0055	0.0060	70	
H8	P	0,065	0,085	0,10	0,12	0,14	0,16	0,17	40	
	P	0.0026	0.0034	0.0040	0.0048	0.0055	0.0065	0.0065	130	
H11	P	0,085	0,11	0,13	0,16	0,18	0,20	0,22	50	
	P	0.0034	0.0044	0.0050	0.0065	0.0070	0.0080	0.0085	165	
H12	P	0,065	0,085	0,10	0,12	0,14	0,16	0,17	31	
	P	0.0026	0.0034	0.0040	0.0048	0.0055	0.0065	0.0065	100	
H21	P	0,065	0,085	0,10	0,12	0,14	0,16	0,17	40	
	P	0.0026	0.0034	0.0040	0.0048	0.0055	0.0065	0.0065	130	

SMG = Gruppo materiale Seco

f = mm/giro

v_c = m/min

Tutti i parametri di taglio sono valori di partenza

SMG		f						v _c
		Ø 3,00 Ø 0.118	Ø 5,00 Ø 0.197	Ø 6,00 Ø 0.236	Ø 8,00 Ø 0.315	Ø 10,00 Ø 0.394	Ø 12,00 Ø 0.472	
P1	P	0,13	0,18	0,20	0,25	0,30	0,32	90
	P	0.0050	0.0070	0.0080	0.010	0.012	0.013	295
P2	P	0,14	0,18	0,20	0,26	0,30	0,34	90
	P	0.0055	0.0070	0.0080	0.010	0.012	0.013	295
P3	P	0,13	0,17	0,20	0,24	0,28	0,32	75
	P	0.0050	0.0065	0.0080	0.0095	0.011	0.013	245
P4	P	0,13	0,17	0,19	0,24	0,28	0,30	70
	P	0.0050	0.0065	0.0075	0.0095	0.011	0.012	230
P5	P	0,12	0,17	0,19	0,24	0,28	0,30	65
	P	0.0048	0.0065	0.0075	0.0095	0.011	0.012	215
P6	P	0,12	0,17	0,19	0,24	0,26	0,30	75
	P	0.0048	0.0065	0.0075	0.0095	0.010	0.012	245
P7	P	0,12	0,17	0,19	0,24	0,26	0,30	70
	P	0.0048	0.0065	0.0075	0.0095	0.010	0.012	230
P8	P	0,13	0,17	0,20	0,24	0,28	0,32	65
	P	0.0050	0.0065	0.0080	0.0095	0.011	0.013	215
P11	P	0,12	0,17	0,19	0,24	0,26	0,30	65
	P	0.0048	0.0065	0.0075	0.0095	0.010	0.012	215
P12	P	0,085	0,11	0,13	0,16	0,18	0,20	39
	P	0.0034	0.0044	0.0050	0.0065	0.0070	0.0080	130
M1	P	0,095	0,13	0,15	0,19	0,22	0,25	50
	P	0.0038	0.0050	0.0060	0.0075	0.0085	0.010	165
M2	P	0,085	0,12	0,14	0,17	0,20	0,22	40
	P	0.0034	0.0048	0.0055	0.0065	0.0080	0.0085	130
M3	P	0,070	0,095	0,11	0,14	0,16	0,18	30
	P	0.0028	0.0038	0.0044	0.0055	0.0065	0.0070	100
M4	P	0,060	0,085	0,095	0,12	0,14	0,16	23
	P	0.0024	0.0034	0.0038	0.0048	0.0055	0.0065	75
M5	P	0,060	0,085	0,095	0,12	0,14	0,16	19
	P	0.0024	0.0034	0.0038	0.0048	0.0055	0.0065	60
K1	P	0,15	0,22	0,24	0,30	0,36	0,40	60
	P	0.0060	0.0085	0.0095	0.012	0.014	0.016	195
K2	P	0,14	0,19	0,22	0,28	0,32	0,36	50
	P	0.0055	0.0075	0.0085	0.011	0.013	0.014	165
K3	P	0,14	0,19	0,22	0,28	0,32	0,36	44
	P	0.0055	0.0075	0.0085	0.011	0.013	0.014	145
K4	P	0,14	0,19	0,22	0,28	0,32	0,36	42
	P	0.0055	0.0075	0.0085	0.011	0.013	0.014	140
K5	P	0,12	0,17	0,20	0,25	0,30	0,32	25
	P	0.0048	0.0065	0.0080	0.010	0.012	0.013	80
N2	P	0,16	0,22	0,26	0,32	0,38	0,42	100
	P	0.0065	0.0085	0.010	0.013	0.015	0.017	330
N3	P	0,16	0,22	0,26	0,32	0,38	0,42	65
	P	0.0065	0.0085	0.010	0.013	0.015	0.017	215
H3	P	0,055	0,075	0,085	0,10	0,12	0,14	16
	P	0.0022	0.0030	0.0034	0.0040	0.0048	0.0055	50
H5	P	0,085	0,11	0,13	0,16	0,18	0,20	30
	P	0.0034	0.0044	0.0050	0.0065	0.0070	0.0080	100
H7	P	0,055	0,075	0,085	0,10	0,12	0,14	16
	P	0.0022	0.0030	0.0034	0.0040	0.0048	0.0055	50
H8	P	0,065	0,085	0,10	0,12	0,14	0,16	30
	P	0.0026	0.0034	0.0040	0.0048	0.0055	0.0065	100
H11	P	0,085	0,11	0,13	0,16	0,18	0,20	39
	P	0.0034	0.0044	0.0050	0.0065	0.0070	0.0080	130
H12	P	0,065	0,085	0,10	0,12	0,14	0,16	24
	P	0.0026	0.0034	0.0040	0.0048	0.0055	0.0065	80
H21	P	0,065	0,085	0,10	0,12	0,14	0,16	30
	P	0.0026	0.0034	0.0040	0.0048	0.0055	0.0065	100

SMG = Gruppo materiale Seco

f = mm/giro

v_c = m/min

Tutti i parametri di taglio sono valori di partenza

Introduzione

Foratura

Alesatura

Barenatura

Allegato

Foratura

Seco Universal™ – Parametri di taglio



SD2040-2060A – Ø 3-8 mm / 0.118-0.315 pollici

SMG	f				V _c
	Ø3,00 Ø 0.118	Ø5,00 Ø 0.197	Ø6,00 Ø 0.236	Ø8,00 Ø 0.315	
P1	0,14	0,18	0,20	0,25	85
	0.0055	0.0070	0.0080	0.010	280
P2	0,14	0,19	0,22	0,26	85
	0.0055	0.0075	0.0085	0.010	280
P3	0,13	0,18	0,20	0,25	70
	0.0050	0.0070	0.0080	0.010	230
P4	0,13	0,17	0,20	0,24	65
	0.0050	0.0065	0.0080	0.0095	215
P5	0,13	0,17	0,19	0,24	60
	0.0050	0.0065	0.0075	0.0095	195
P6	0,12	0,17	0,19	0,24	65
	0.0048	0.0065	0.0075	0.0095	215
P7	0,12	0,17	0,19	0,24	65
	0.0048	0.0065	0.0075	0.0095	215
P8	0,13	0,18	0,20	0,25	60
	0.0050	0.0070	0.0080	0.010	195
P11	0,12	0,17	0,19	0,24	60
	0.0048	0.0065	0.0075	0.0095	195
P12	0,085	0,12	0,13	0,16	36
	0.0034	0.0048	0.0050	0.0065	120
M1	0,095	0,13	0,15	0,19	37
	0.0038	0.0050	0.0060	0.0075	120
M2	0,085	0,12	0,14	0,17	30
	0.0034	0.0048	0.0055	0.0065	100
M3	0,070	0,095	0,11	0,14	23
	0.0028	0.0038	0.0044	0.0055	75
M4	0,060	0,085	0,095	0,12	17
	0.0024	0.0034	0.0038	0.0048	55
M5	0,060	0,085	0,095	0,12	14
	0.0024	0.0034	0.0038	0.0048	46
K1	0,15	0,22	0,25	0,30	43
	0.0060	0.0085	0.010	0.012	140
K2	0,14	0,20	0,22	0,28	37
	0.0055	0.0080	0.0085	0.011	120
K3	0,14	0,20	0,22	0,28	31
	0.0055	0.0080	0.0085	0.011	100
K4	0,14	0,20	0,22	0,28	30
	0.0055	0.0080	0.0085	0.011	100
K5	0,13	0,18	0,20	0,25	18
	0.0050	0.0070	0.0080	0.010	60
N2	0,16	0,22	0,26	0,32	105
	0.0065	0.0085	0.010	0.013	345
N3	0,16	0,22	0,26	0,32	70
	0.0065	0.0085	0.010	0.013	230

SMG = Gruppo materiale Seco

f = mm/giro

V_c = m/min

Tutti i parametri di taglio sono valori di partenza

Introduzione

Foratura

Alesatura

Barenatura

Allegato

SMG		f							V _c
		Ø 4,00 Ø 0.157	Ø 6,00 Ø 0.236	Ø 8,00 Ø 0.315	Ø 10,00 Ø 0.394	Ø 12,00 Ø 0.472	Ø 14,00 Ø 0.551	Ø 16,00 Ø 0.630	
P1	P	0,11	0,15	0,19	0,22	0,26	0,28	0,32	185
	P	0.0044	0.0060	0.0075	0.0085	0.010	0.011	0.013	610
P2	P	0,11	0,15	0,19	0,22	0,26	0,30	0,32	180
	P	0.0044	0.0060	0.0075	0.0085	0.010	0.012	0.013	590
P3	P	0,11	0,14	0,18	0,22	0,25	0,28	0,30	155
	P	0.0044	0.0055	0.0070	0.0085	0.010	0.011	0.012	510
P4	P	0,11	0,14	0,18	0,22	0,24	0,26	0,30	135
	P	0.0044	0.0055	0.0070	0.0085	0.0095	0.010	0.012	445
P5	P	0,10	0,14	0,17	0,20	0,24	0,26	0,28	130
	P	0.0040	0.0055	0.0065	0.0080	0.0095	0.010	0.011	425
P6	P	0,10	0,14	0,17	0,20	0,24	0,26	0,28	145
	P	0.0040	0.0055	0.0065	0.0080	0.0095	0.010	0.011	475
P7	P	0,10	0,14	0,17	0,20	0,24	0,26	0,28	140
	P	0.0040	0.0055	0.0065	0.0080	0.0095	0.010	0.011	460
P8	P	0,11	0,14	0,18	0,22	0,25	0,28	0,30	130
	P	0.0044	0.0055	0.0070	0.0085	0.010	0.011	0.012	425
P11	P	0,10	0,14	0,17	0,20	0,24	0,26	0,28	135
	P	0.0040	0.0055	0.0065	0.0080	0.0095	0.010	0.011	445
P12	P	0,070	0,095	0,12	0,14	0,16	0,18	0,20	80
	P	0.0028	0.0038	0.0048	0.0055	0.0065	0.0070	0.0080	260
M1	P	0,11	0,15	0,19	0,22	0,26	0,30	0,32	100
	P	0.0044	0.0060	0.0075	0.0085	0.010	0.012	0.013	330
M2	P	0,10	0,14	0,17	0,20	0,24	0,26	0,28	80
	P	0.0040	0.0055	0.0065	0.0080	0.0095	0.010	0.011	260
K1	P	0,11	0,15	0,19	0,22	0,26	0,30	0,32	120
	P	0.0044	0.0060	0.0075	0.0085	0.010	0.012	0.013	395
K2	P	0,10	0,14	0,17	0,20	0,24	0,26	0,28	105
	P	0.0040	0.0055	0.0065	0.0080	0.0095	0.010	0.011	345
K3	P	0,10	0,14	0,17	0,20	0,24	0,26	0,28	90
	P	0.0040	0.0055	0.0065	0.0080	0.0095	0.010	0.011	295
K4	P	0,10	0,14	0,17	0,20	0,24	0,26	0,28	85
	P	0.0040	0.0055	0.0065	0.0080	0.0095	0.010	0.011	280
K5	P	0,095	0,12	0,16	0,19	0,22	0,24	0,26	50
	P	0.0038	0.0048	0.0065	0.0075	0.0085	0.0095	0.010	165
N2	P	0,14	0,19	0,24	0,28	0,34	0,38	0,40	200
	P	0.0055	0.0075	0.0095	0.011	0.013	0.015	0.016	660
N3	P	0,14	0,19	0,24	0,28	0,34	0,38	0,40	135
	P	0.0055	0.0075	0.0095	0.011	0.013	0.015	0.016	445
N11	P	0,14	0,19	0,24	0,28	0,34	0,38	0,40	255
	P	0.0055	0.0075	0.0095	0.011	0.013	0.015	0.016	840

SMG = Gruppo materiale Seco

f = mm/giro

V_c = m/min

Tutti i parametri di taglio sono valori di partenza

Introduzione

Foratura

Alesatura

Barenatura

Allegato

Foratura

Seco Universal™ – Parametri di taglio



SD265A – Ø 4-16 mm / 0.157-0.630 pollici

SMG		f							V _c
		Ø 4,00 Ø 0.157	Ø 6,00 Ø 0.236	Ø 8,00 Ø 0.315	Ø 10,00 Ø 0.394	Ø 12,00 Ø 0.472	Ø 14,00 Ø 0.551	Ø 16,00 Ø 0.630	
P1	P	0,12	0,16	0,20	0,24	0,28	0,30	0,34	180
	P	0.0048	0.0065	0.0080	0.0095	0.011	0.012	0.013	590
P2	P	0,12	0,16	0,20	0,24	0,28	0,30	0,34	175
	P	0.0048	0.0065	0.0080	0.0095	0.011	0.012	0.013	570
P3	P	0,11	0,15	0,19	0,22	0,26	0,30	0,32	150
	P	0.0044	0.0060	0.0075	0.0085	0.010	0.012	0.013	490
P4	P	0,11	0,15	0,19	0,22	0,26	0,28	0,32	135
	P	0.0044	0.0060	0.0075	0.0085	0.010	0.011	0.013	445
P5	P	0,11	0,15	0,18	0,22	0,25	0,28	0,30	130
	P	0.0044	0.0060	0.0070	0.0085	0.010	0.011	0.012	425
P6	P	0,11	0,15	0,18	0,22	0,25	0,28	0,30	145
	P	0.0044	0.0060	0.0070	0.0085	0.010	0.011	0.012	475
P7	P	0,11	0,15	0,18	0,22	0,25	0,28	0,30	135
	P	0.0044	0.0060	0.0070	0.0085	0.010	0.011	0.012	445
P8	P	0,11	0,15	0,19	0,22	0,26	0,30	0,32	130
	P	0.0044	0.0060	0.0075	0.0085	0.010	0.012	0.013	425
P11	P	0,11	0,15	0,18	0,22	0,25	0,28	0,30	130
	P	0.0044	0.0060	0.0070	0.0085	0.010	0.011	0.012	425
P12	P	0,075	0,10	0,12	0,15	0,17	0,19	0,20	80
	P	0.0030	0.0040	0.0048	0.0060	0.0065	0.0075	0.0080	260
M1	P	0,12	0,16	0,20	0,24	0,28	0,30	0,34	100
	P	0.0048	0.0065	0.0080	0.0095	0.011	0.012	0.013	330
M2	P	0,11	0,15	0,18	0,22	0,25	0,28	0,30	80
	P	0.0044	0.0060	0.0070	0.0085	0.010	0.011	0.012	260
K1	P	0,12	0,16	0,20	0,24	0,28	0,30	0,34	120
	P	0.0048	0.0065	0.0080	0.0095	0.011	0.012	0.013	395
K2	P	0,11	0,15	0,18	0,22	0,25	0,28	0,30	100
	P	0.0044	0.0060	0.0070	0.0085	0.010	0.011	0.012	330
K3	P	0,11	0,15	0,18	0,22	0,25	0,28	0,30	85
	P	0.0044	0.0060	0.0070	0.0085	0.010	0.011	0.012	280
K4	P	0,11	0,15	0,18	0,22	0,25	0,28	0,30	85
	P	0.0044	0.0060	0.0070	0.0085	0.010	0.011	0.012	280
K5	P	0,10	0,13	0,17	0,20	0,22	0,25	0,28	49
	P	0.0040	0.0050	0.0065	0.0080	0.0085	0.010	0.011	160
N2	P	0,15	0,20	0,26	0,30	0,36	0,40	0,42	195
	P	0.0060	0.0080	0.010	0.012	0.014	0.016	0.017	640
N3	P	0,15	0,20	0,26	0,30	0,36	0,40	0,42	130
	P	0.0060	0.0080	0.010	0.012	0.014	0.016	0.017	425
N11	P	0,15	0,20	0,26	0,30	0,36	0,40	0,42	250
	P	0.0060	0.0080	0.010	0.012	0.014	0.016	0.017	820

SMG = Gruppo materiale Seco

f = mm/giro

V_c = m/min

Tutti i parametri di taglio sono valori di partenza

Introduzione

Foratura

Alesatura

Barenatura

Allegato

SMG		f						v _c
		Ø 2,00 Ø 0.079	Ø 3,00 Ø 0.118	Ø 4,00 Ø 0.157	Ø 5,00 Ø 0.197	Ø 6,00 Ø 0.236	Ø 8,00 Ø 0.315	
P11	MS	0,060	0,080	0,10	0,12	0,14	0,18	90
	MS	0.0024	0.0032	0.0040	0.0048	0.0055	0.0070	295
P12	MS	0,060	0,070	0,080	0,090	0,10	0,12	65
	MS	0.0024	0.0028	0.0032	0.0036	0.0040	0.0048	215
M1	MS	0,075	0,095	0,11	0,13	0,15	0,19	110
	MS	0.0030	0.0038	0.0044	0.0050	0.0060	0.0075	360
M2	MS	0,065	0,085	0,10	0,12	0,14	0,17	90
	MS	0.0026	0.0034	0.0040	0.0048	0.0055	0.0065	295
M3	MS	0,095	0,11	0,13	0,15	0,17	0,20	45
	MS	0.0038	0.0044	0.0050	0.0060	0.0065	0.0080	150
M4	MS	0,048	0,060	0,070	0,085	0,095	0,12	50
	MS	0.0019	0.0024	0.0028	0.0034	0.0038	0.0048	165
M5	MS	0,048	0,060	0,070	0,085	0,095	0,12	42
	MS	0.0019	0.0024	0.0028	0.0034	0.0038	0.0048	140
N1	MS	0,13	0,16	0,19	0,22	0,26	0,32	345
	MS	0.0050	0.0065	0.0075	0.0085	0.010	0.013	1125
N2	MS	0,13	0,16	0,19	0,22	0,26	0,32	225
	MS	0.0050	0.0065	0.0075	0.0085	0.010	0.013	740
N3	MS	0,13	0,16	0,19	0,22	0,26	0,32	150
	MS	0.0050	0.0065	0.0075	0.0085	0.010	0.013	490
N11	MS	0,13	0,16	0,19	0,22	0,26	0,32	285
	MS	0.0050	0.0065	0.0075	0.0085	0.010	0.013	940
S1	MS	0,040	0,048	0,055	0,065	0,075	0,095	39
	MS	0.0016	0.0019	0.0022	0.0026	0.0030	0.0038	130
S2	MS	0,040	0,048	0,055	0,065	0,075	0,095	28
	MS	0.0016	0.0019	0.0022	0.0026	0.0030	0.0038	90
S3	MS	0,040	0,048	0,055	0,065	0,075	0,095	28
	MS	0.0016	0.0019	0.0022	0.0026	0.0030	0.0038	90
S11	MS	0,070	0,085	0,095	0,11	0,12	0,14	70
	MS	0.0028	0.0034	0.0038	0.0044	0.0048	0.0055	230
S12	MS	0,070	0,085	0,095	0,11	0,12	0,14	55
	MS	0.0028	0.0034	0.0038	0.0044	0.0048	0.0055	180
S13	MS	0,065	0,075	0,085	0,095	0,10	0,12	43
	MS	0.0026	0.0030	0.0034	0.0038	0.0040	0.0048	140
H3	MS	0,046	0,055	0,065	0,075	0,085	0,10	36
	MS	0.0018	0.0022	0.0026	0.0030	0.0034	0.0040	120
H5	MS	0,070	0,085	0,10	0,11	0,13	0,16	65
	MS	0.0028	0.0034	0.0040	0.0044	0.0050	0.0065	215
H7	MS	0,046	0,055	0,065	0,075	0,085	0,10	36
	MS	0.0018	0.0022	0.0026	0.0030	0.0034	0.0040	120
H8	MS	0,055	0,065	0,075	0,085	0,095	0,12	65
	MS	0.0022	0.0026	0.0030	0.0034	0.0038	0.0048	215
H11	MS	0,070	0,085	0,10	0,11	0,13	0,16	85
	MS	0.0028	0.0034	0.0040	0.0044	0.0050	0.0065	280
H12	MS	0,055	0,065	0,075	0,085	0,095	0,12	80
	MS	0.0022	0.0026	0.0030	0.0034	0.0038	0.0048	260
H21	MS	0,055	0,065	0,075	0,085	0,095	0,12	65
	MS	0.0022	0.0026	0.0030	0.0034	0.0038	0.0048	215

SMG = Gruppo materiale Seco

f = mm/giro

v_c = m/min

Tutti i parametri di taglio sono valori di partenza

Introduzione

Foratura

Alesatura

Barenatura

Allegato

Foratura

Seco Universal™ – Parametri di taglio



SD203A -MS Ø 10-20 mm / 0.394-0.787 pollici

SMG	f							V _c
	Ø 10,00 Ø 0.394	Ø 12,00 Ø 0.472	Ø 14,00 Ø 0.551	Ø 16,00 Ø 0.630	Ø 18,00 Ø 0.709	Ø 20,00 Ø 0.787		
P11	MS	0,22	0,24	0,26	0,30	0,30	0,32	90
	MS	0.0085	0.0095	0.010	0.012	0.012	0.013	295
P12	MS	0,14	0,15	0,16	0,18	0,18	0,19	65
	MS	0.0055	0.0060	0.0065	0.0070	0.0070	0.0075	215
M1	MS	0,22	0,25	0,28	0,30	0,30	0,32	110
	MS	0.0085	0.010	0.011	0.012	0.012	0.013	360
M2	MS	0,20	0,22	0,25	0,26	0,28	0,30	90
	MS	0.0080	0.0085	0.010	0.010	0.011	0.012	295
M3	MS	0,24	0,26	0,28	0,30	0,32	0,34	45
	MS	0.0095	0.010	0.011	0.012	0.013	0.013	150
M4	MS	0,14	0,16	0,17	0,19	0,20	0,20	50
	MS	0.0055	0.0065	0.0065	0.0075	0.0080	0.0080	165
M5	MS	0,14	0,16	0,17	0,19	0,20	0,20	42
	MS	0.0055	0.0065	0.0065	0.0075	0.0080	0.0080	140
N1	MS	0,38	0,42	0,46	0,50	0,55	0,55	345
	MS	0.015	0.017	0.018	0.020	0.022	0.022	1125
N2	MS	0,38	0,42	0,46	0,50	0,55	0,55	225
	MS	0.015	0.017	0.018	0.020	0.022	0.022	740
N3	MS	0,38	0,42	0,46	0,50	0,55	0,55	150
	MS	0.015	0.017	0.018	0.020	0.022	0.022	490
N11	MS	0,38	0,42	0,46	0,50	0,55	0,55	285
	MS	0.015	0.017	0.018	0.020	0.022	0.022	940
S1	MS	0,11	0,13	0,15	0,16	0,17	0,19	39
	MS	0.0044	0.0050	0.0060	0.0065	0.0065	0.0075	130
S2	MS	0,11	0,13	0,15	0,16	0,17	0,19	28
	MS	0.0044	0.0050	0.0060	0.0065	0.0065	0.0075	90
S3	MS	0,11	0,13	0,15	0,16	0,17	0,19	28
	MS	0.0044	0.0050	0.0060	0.0065	0.0065	0.0075	90
S11	MS	0,17	0,19	0,22	0,24	0,25	0,26	70
	MS	0.0065	0.0075	0.0085	0.0095	0.010	0.010	230
S12	MS	0,17	0,19	0,22	0,24	0,25	0,26	55
	MS	0.0065	0.0075	0.0085	0.0095	0.010	0.010	180
S13	MS	0,15	0,17	0,19	0,20	0,22	0,22	43
	MS	0.0060	0.0065	0.0075	0.0080	0.0085	0.0085	140
H3	MS	0,12	0,13	0,15	0,16	0,17	0,17	36
	MS	0.0048	0.0050	0.0060	0.0065	0.0065	0.0065	120
H5	MS	0,18	0,20	0,22	0,24	0,25	0,26	65
	MS	0.0070	0.0080	0.0085	0.0095	0.010	0.010	215
H7	MS	0,12	0,13	0,15	0,16	0,17	0,17	36
	MS	0.0048	0.0050	0.0060	0.0065	0.0065	0.0065	120
H8	MS	0,14	0,16	0,17	0,18	0,19	0,20	65
	MS	0.0055	0.0065	0.0065	0.0070	0.0075	0.0080	215
H11	MS	0,18	0,20	0,22	0,24	0,25	0,26	85
	MS	0.0070	0.0080	0.0085	0.0095	0.010	0.010	280
H12	MS	0,14	0,16	0,17	0,18	0,19	0,20	80
	MS	0.0055	0.0065	0.0065	0.0070	0.0075	0.0080	260
H21	MS	0,14	0,16	0,17	0,18	0,19	0,20	65
	MS	0.0055	0.0065	0.0065	0.0070	0.0075	0.0080	215

SMG = Gruppo materiale Seco

f = mm/giro

v_c = m/min

Tutti i parametri di taglio sono valori di partenza

Introduzione

Foratura

Alesatura

Barenatura

Allegato

SMG		f						v _c
		Ø 2,00 Ø 0.079	Ø 3,00 Ø 0.118	Ø 4,00 Ø 0.157	Ø 5,00 Ø 0.197	Ø 6,00 Ø 0.236	Ø 8,00 Ø 0.315	
P11	MS	0,060	0,080	0,10	0,12	0,14	0,18	80
	MS	0.0024	0.0032	0.0040	0.0048	0.0055	0.0070	260
P12	MS	0,060	0,070	0,080	0,090	0,10	0,12	60
	MS	0.0024	0.0028	0.0032	0.0036	0.0040	0.0048	195
M1	MS	0,075	0,095	0,11	0,13	0,15	0,19	100
	MS	0.0030	0.0038	0.0044	0.0050	0.0060	0.0075	330
M2	MS	0,065	0,085	0,10	0,12	0,14	0,17	80
	MS	0.0026	0.0034	0.0040	0.0048	0.0055	0.0065	260
M3	MS	0,095	0,11	0,13	0,15	0,17	0,20	40
	MS	0.0038	0.0044	0.0050	0.0060	0.0065	0.0080	130
M4	MS	0,048	0,060	0,070	0,085	0,095	0,12	46
	MS	0.0019	0.0024	0.0028	0.0034	0.0038	0.0048	150
M5	MS	0,048	0,060	0,070	0,085	0,095	0,12	38
	MS	0.0019	0.0024	0.0028	0.0034	0.0038	0.0048	125
N1	MS	0,13	0,16	0,19	0,22	0,26	0,32	310
	MS	0.0050	0.0065	0.0075	0.0085	0.010	0.013	1025
N2	MS	0,13	0,16	0,19	0,22	0,26	0,32	200
	MS	0.0050	0.0065	0.0075	0.0085	0.010	0.013	660
N3	MS	0,13	0,16	0,19	0,22	0,26	0,32	135
	MS	0.0050	0.0065	0.0075	0.0085	0.010	0.013	445
N11	MS	0,13	0,16	0,19	0,22	0,26	0,32	255
	MS	0.0050	0.0065	0.0075	0.0085	0.010	0.013	840
S1	MS	0,040	0,048	0,055	0,065	0,075	0,095	35
	MS	0.0016	0.0019	0.0022	0.0026	0.0030	0.0038	115
S2	MS	0,040	0,048	0,055	0,065	0,075	0,095	25
	MS	0.0016	0.0019	0.0022	0.0026	0.0030	0.0038	80
S3	MS	0,040	0,048	0,055	0,065	0,075	0,095	25
	MS	0.0016	0.0019	0.0022	0.0026	0.0030	0.0038	80
S11	MS	0,020	0,030	0,040	0,050	0,060	0,080	45
	MS	0.00080	0.0012	0.0016	0.0020	0.0024	0.0032	150
S12	MS	0,020	0,030	0,040	0,050	0,060	0,080	35
	MS	0.00080	0.0012	0.0016	0.0020	0.0024	0.0032	115
S13	MS	0,017	0,026	0,035	0,044	0,050	0,070	27
	MS	0.00068	0.0010	0.0014	0.0018	0.0020	0.0028	90
H3	MS	0,046	0,055	0,065	0,075	0,085	0,10	33
	MS	0.0018	0.0022	0.0026	0.0030	0.0034	0.0040	110
H5	MS	0,070	0,085	0,10	0,11	0,13	0,16	60
	MS	0.0028	0.0034	0.0040	0.0044	0.0050	0.0065	195
H7	MS	0,046	0,055	0,065	0,075	0,085	0,10	33
	MS	0.0018	0.0022	0.0026	0.0030	0.0034	0.0040	110
H8	MS	0,055	0,065	0,075	0,085	0,095	0,12	60
	MS	0.0022	0.0026	0.0030	0.0034	0.0038	0.0048	195
H11	MS	0,070	0,085	0,10	0,11	0,13	0,16	75
	MS	0.0028	0.0034	0.0040	0.0044	0.0050	0.0065	245
H12	MS	0,055	0,065	0,075	0,085	0,095	0,12	70
	MS	0.0022	0.0026	0.0030	0.0034	0.0038	0.0048	230
H21	MS	0,055	0,065	0,075	0,085	0,095	0,12	60
	MS	0.0022	0.0026	0.0030	0.0034	0.0038	0.0048	195

SMG = Gruppo materiale Seco

f = mm/giro

v_c = m/min

Tutti i parametri di taglio sono valori di partenza

Introduzione

Foratura

Alesatura

Barenatura

Allegato

Foratura

Seco Universal™ – Parametri di taglio



SD205A -MS Ø 10-20 mm / 0.394-0.787 pollici

SMG		f						V _c
		Ø 10,00 Ø 0.394	Ø 12,00 Ø 0.472	Ø 14,00 Ø 0.551	Ø 16,00 Ø 0.630	Ø 18,00 Ø 0.709	Ø 20,00 Ø 0.787	
P11	MS	0,22	0,24	0,26	0,30	0,30	0,32	80
	MS	0.0085	0.0095	0.010	0.012	0.012	0.013	260
P12	MS	0,14	0,15	0,16	0,18	0,18	0,19	60
	MS	0.0055	0.0060	0.0065	0.0070	0.0070	0.0075	195
M1	MS	0,22	0,25	0,28	0,30	0,30	0,32	100
	MS	0.0085	0.010	0.011	0.012	0.012	0.013	330
M2	MS	0,20	0,22	0,25	0,26	0,28	0,30	80
	MS	0.0080	0.0085	0.010	0.010	0.011	0.012	260
M3	MS	0,24	0,26	0,28	0,30	0,32	0,34	40
	MS	0.0095	0.010	0.011	0.012	0.013	0.013	130
M4	MS	0,14	0,16	0,17	0,19	0,20	0,20	46
	MS	0.0055	0.0065	0.0065	0.0075	0.0080	0.0080	150
M5	MS	0,14	0,16	0,17	0,19	0,20	0,20	38
	MS	0.0055	0.0065	0.0065	0.0075	0.0080	0.0080	125
N1	MS	0,38	0,42	0,46	0,50	0,55	0,55	310
	MS	0.015	0.017	0.018	0.020	0.022	0.022	1025
N2	MS	0,38	0,42	0,46	0,50	0,55	0,55	200
	MS	0.015	0.017	0.018	0.020	0.022	0.022	660
N3	MS	0,38	0,42	0,46	0,50	0,55	0,55	135
	MS	0.015	0.017	0.018	0.020	0.022	0.022	445
N11	MS	0,38	0,42	0,46	0,50	0,55	0,55	255
	MS	0.015	0.017	0.018	0.020	0.022	0.022	840
S1	MS	0,11	0,13	0,15	0,16	0,17	0,19	35
	MS	0.0044	0.0050	0.0060	0.0065	0.0065	0.0075	115
S2	MS	0,11	0,13	0,15	0,16	0,17	0,19	25
	MS	0.0044	0.0050	0.0060	0.0065	0.0065	0.0075	80
S3	MS	0,11	0,13	0,15	0,16	0,17	0,19	25
	MS	0.0044	0.0050	0.0060	0.0065	0.0065	0.0075	80
S11	MS	0,10	0,12	0,14	0,16	0,18	0,20	45
	MS	0.0040	0.0048	0.0055	0.0065	0.0070	0.0080	150
S12	MS	0,10	0,12	0,14	0,16	0,18	0,20	35
	MS	0.0040	0.0048	0.0055	0.0065	0.0070	0.0080	115
S13	MS	0,085	0,11	0,12	0,14	0,16	0,17	27
	MS	0.0034	0.0044	0.0048	0.0055	0.0065	0.0070	90
H3	MS	0,12	0,13	0,15	0,16	0,17	0,17	33
	MS	0.0048	0.0050	0.0060	0.0065	0.0065	0.0065	110
H5	MS	0,18	0,20	0,22	0,24	0,25	0,26	60
	MS	0.0070	0.0080	0.0085	0.0095	0.010	0.010	195
H7	MS	0,12	0,13	0,15	0,16	0,17	0,17	33
	MS	0.0048	0.0050	0.0060	0.0065	0.0065	0.0065	110
H8	MS	0,14	0,16	0,17	0,18	0,19	0,20	60
	MS	0.0055	0.0065	0.0065	0.0070	0.0075	0.0080	195
H11	MS	0,18	0,20	0,22	0,24	0,25	0,26	75
	MS	0.0070	0.0080	0.0085	0.0095	0.010	0.010	245
H12	MS	0,14	0,16	0,17	0,18	0,19	0,20	70
	MS	0.0055	0.0065	0.0065	0.0070	0.0075	0.0080	230
H21	MS	0,14	0,16	0,17	0,18	0,19	0,20	60
	MS	0.0055	0.0065	0.0065	0.0070	0.0075	0.0080	195

SMG = Gruppo materiale Seco

f = mm/giro

v_c = m/min

Tutti i parametri di taglio sono valori di partenza

Barenatura

Allegato

SMG		f						v _c
		Ø 2,00 Ø 0.079	Ø 3,00 Ø 0.118	Ø 4,00 Ø 0.157	Ø 5,00 Ø 0.197	Ø 6,00 Ø 0.236	Ø 8,00 Ø 0.315	
P11	M	0,060	0,075	0,085	0,10	0,11	0,14	150
	M	0.0024	0.0030	0.0034	0.0040	0.0044	0.0055	490
P12	M	0,060	0,075	0,085	0,10	0,11	0,14	90
	M	0.0024	0.0030	0.0034	0.0040	0.0044	0.0055	295
M1	M	0,075	0,095	0,11	0,13	0,15	0,19	110
	M	0.0030	0.0038	0.0044	0.0050	0.0060	0.0075	360
M2	M	0,065	0,085	0,10	0,12	0,14	0,17	90
	M	0.0026	0.0034	0.0040	0.0048	0.0055	0.0065	295
M3	M	0,055	0,065	0,080	0,095	0,11	0,14	70
	M	0.0022	0.0026	0.0032	0.0038	0.0044	0.0055	230
M4	M	0,048	0,060	0,070	0,085	0,095	0,12	50
	M	0.0019	0.0024	0.0028	0.0034	0.0038	0.0048	165
M5	M	0,048	0,060	0,070	0,085	0,095	0,12	42
	M	0.0019	0.0024	0.0028	0.0034	0.0038	0.0048	140
N1	M	0,13	0,16	0,19	0,22	0,26	0,32	345
	M	0.0050	0.0065	0.0075	0.0085	0.010	0.013	1125
N2	M	0,13	0,16	0,19	0,22	0,26	0,32	225
	M	0.0050	0.0065	0.0075	0.0085	0.010	0.013	740
N3	M	0,13	0,16	0,19	0,22	0,26	0,32	150
	M	0.0050	0.0065	0.0075	0.0085	0.010	0.013	490
N11	M	0,13	0,16	0,19	0,22	0,26	0,32	285
	M	0.0050	0.0065	0.0075	0.0085	0.010	0.013	940
S1	M	0,040	0,048	0,055	0,065	0,075	0,095	39
	M	0.0016	0.0019	0.0022	0.0026	0.0030	0.0038	130
S2	M	0,040	0,048	0,055	0,065	0,075	0,095	28
	M	0.0016	0.0019	0.0022	0.0026	0.0030	0.0038	90
S3	M	0,040	0,048	0,055	0,065	0,075	0,095	28
	M	0.0016	0.0019	0.0022	0.0026	0.0030	0.0038	90
S11	M	0,070	0,085	0,095	0,11	0,12	0,14	70
	M	0.0028	0.0034	0.0038	0.0044	0.0048	0.0055	230
S12	M	0,070	0,085	0,095	0,11	0,12	0,14	55
	M	0.0028	0.0034	0.0038	0.0044	0.0048	0.0055	180
S13	M	0,065	0,075	0,085	0,095	0,10	0,12	43
	M	0.0026	0.0030	0.0034	0.0038	0.0040	0.0048	140

SMG = Gruppo materiale Seco

f = mm/giro

v_c = m/min

Tutti i parametri di taglio sono valori di partenza

Introduzione

Foratura

Alesatura

Barenatura

Allegato

SD203A – Ø 10-20 mm / 0.394-0.787 pollici

SMG		f						V _c
		Ø 10,00 Ø 0.394	Ø 12,00 Ø 0.472	Ø 14,00 Ø 0.551	Ø 16,00 Ø 0.630	Ø 18,00 Ø 0.709	Ø 20,00 Ø 0.787	
P11	M	0,16	0,18	0,20	0,22	0,24	0,24	150
	M	0.0065	0.0070	0.0080	0.0085	0.0095	0.0095	490
P12	M	0,16	0,18	0,20	0,22	0,24	0,24	90
	M	0.0065	0.0070	0.0080	0.0085	0.0095	0.0095	295
M1	M	0,22	0,25	0,28	0,30	0,30	0,32	110
	M	0.0085	0.010	0.011	0.012	0.012	0.013	360
M2	M	0,20	0,22	0,25	0,26	0,28	0,30	90
	M	0.0080	0.0085	0.010	0.010	0.011	0.012	295
M3	M	0,16	0,18	0,20	0,22	0,22	0,24	70
	M	0.0065	0.0070	0.0080	0.0085	0.0085	0.0095	230
M4	M	0,14	0,16	0,17	0,19	0,20	0,20	50
	M	0.0055	0.0065	0.0065	0.0075	0.0080	0.0080	165
M5	M	0,14	0,16	0,17	0,19	0,20	0,20	42
	M	0.0055	0.0065	0.0065	0.0075	0.0080	0.0080	140
N1	M	0,38	0,42	0,46	0,50	0,55	0,55	345
	M	0.015	0.017	0.018	0.020	0.022	0.022	1125
N2	M	0,38	0,42	0,46	0,50	0,55	0,55	225
	M	0.015	0.017	0.018	0.020	0.022	0.022	740
N3	M	0,38	0,42	0,46	0,50	0,55	0,55	150
	M	0.015	0.017	0.018	0.020	0.022	0.022	490
N11	M	0,38	0,42	0,46	0,50	0,55	0,55	285
	M	0.015	0.017	0.018	0.020	0.022	0.022	940
S1	M	0,11	0,13	0,15	0,16	0,17	0,19	39
	M	0.0044	0.0050	0.0060	0.0065	0.0065	0.0075	130
S2	M	0,11	0,13	0,15	0,16	0,17	0,19	28
	M	0.0044	0.0050	0.0060	0.0065	0.0065	0.0075	90
S3	M	0,11	0,13	0,15	0,16	0,17	0,19	28
	M	0.0044	0.0050	0.0060	0.0065	0.0065	0.0075	90
S11	M	0,17	0,19	0,22	0,24	0,25	0,26	70
	M	0.0065	0.0075	0.0085	0.0095	0.010	0.010	230
S12	M	0,17	0,19	0,22	0,24	0,25	0,26	55
	M	0.0065	0.0075	0.0085	0.0095	0.010	0.010	180
S13	M	0,15	0,17	0,19	0,20	0,22	0,22	43
	M	0.0060	0.0065	0.0075	0.0080	0.0085	0.0085	140

SMG = Gruppo materiale Seco
f = mm/giro
v_c = m/min
Tutti i parametri di taglio sono valori di partenza

Introduzione

Foratura

Alésatura

Barenatura

Allegato

SMG		f						v _c
		Ø2,00 Ø 0.079	Ø3,00 Ø 0.118	Ø4,00 Ø 0.157	Ø5,00 Ø 0.197	Ø6,00 Ø 0.236	Ø8,00 Ø 0.315	
P11	M	0,060	0,075	0,085	0,10	0,11	0,14	135
	M	0.0024	0.0030	0.0034	0.0040	0.0044	0.0055	445
P12	M	0,060	0,075	0,085	0,10	0,11	0,14	80
	M	0.0024	0.0030	0.0034	0.0040	0.0044	0.0055	260
M1	M	0,075	0,095	0,11	0,13	0,15	0,19	100
	M	0.0030	0.0038	0.0044	0.0050	0.0060	0.0075	330
M2	M	0,065	0,085	0,10	0,12	0,14	0,17	80
	M	0.0026	0.0034	0.0040	0.0048	0.0055	0.0065	260
M3	M	0,055	0,065	0,080	0,095	0,11	0,14	60
	M	0.0022	0.0026	0.0032	0.0038	0.0044	0.0055	195
M4	M	0,048	0,060	0,070	0,085	0,095	0,12	46
	M	0.0019	0.0024	0.0028	0.0034	0.0038	0.0048	150
M5	M	0,048	0,060	0,070	0,085	0,095	0,12	38
	M	0.0019	0.0024	0.0028	0.0034	0.0038	0.0048	125
N1	M	0,13	0,16	0,19	0,22	0,26	0,32	310
	M	0.0050	0.0065	0.0075	0.0085	0.010	0.013	1025
N2	M	0,13	0,16	0,19	0,22	0,26	0,32	200
	M	0.0050	0.0065	0.0075	0.0085	0.010	0.013	660
N3	M	0,13	0,16	0,19	0,22	0,26	0,32	135
	M	0.0050	0.0065	0.0075	0.0085	0.010	0.013	445
N11	M	0,13	0,16	0,19	0,22	0,26	0,32	255
	M	0.0050	0.0065	0.0075	0.0085	0.010	0.013	840
S1	M	0,040	0,048	0,055	0,065	0,075	0,095	35
	M	0.0016	0.0019	0.0022	0.0026	0.0030	0.0038	115
S2	M	0,040	0,048	0,055	0,065	0,075	0,095	25
	M	0.0016	0.0019	0.0022	0.0026	0.0030	0.0038	80
S3	M	0,040	0,048	0,055	0,065	0,075	0,095	25
	M	0.0016	0.0019	0.0022	0.0026	0.0030	0.0038	80
S11	M	0,070	0,085	0,095	0,11	0,12	0,14	65
	M	0.0028	0.0034	0.0038	0.0044	0.0048	0.0055	215
S12	M	0,070	0,085	0,095	0,11	0,12	0,14	50
	M	0.0028	0.0034	0.0038	0.0044	0.0048	0.0055	165
S13	M	0,065	0,075	0,085	0,095	0,10	0,12	39
	M	0.0026	0.0030	0.0034	0.0038	0.0040	0.0048	130

SMG = Gruppo materiale Seco

f = mm/giro

v_c = m/min

Tutti i parametri di taglio sono valori di partenza

Introduzione

Foratura

Alesatura

Barenatura

Allegato

Foratura

Seco Universal™ – Parametri di taglio



SD205A-M – Ø 10-20 mm / 0.394-0.787 pollici

SMG		f						V _c
		Ø10,00 Ø 0.394	Ø12,00 Ø 0.472	Ø14,00 Ø 0.551	Ø16,00 Ø 0.630	Ø18,00 Ø 0.709	Ø20,00 Ø 0.787	
P11	M	0,16	0,18	0,20	0,22	0,24	0,24	135
	M	0.0065	0.0070	0.0080	0.0085	0.0095	0.0095	445
P12	M	0,16	0,18	0,20	0,22	0,24	0,24	80
	M	0.0065	0.0070	0.0080	0.0085	0.0095	0.0095	260
M1	M	0,22	0,25	0,28	0,30	0,30	0,32	100
	M	0.0085	0.010	0.011	0.012	0.012	0.013	330
M2	M	0,20	0,22	0,25	0,26	0,28	0,30	80
	M	0.0080	0.0085	0.010	0.010	0.011	0.012	260
M3	M	0,16	0,18	0,20	0,22	0,22	0,24	60
	M	0.0065	0.0070	0.0080	0.0085	0.0085	0.0095	195
M4	M	0,14	0,16	0,17	0,19	0,20	0,20	45
	M	0.0055	0.0065	0.0065	0.0075	0.0080	0.0080	150
M5	M	0,14	0,16	0,17	0,19	0,20	0,20	37
	M	0.0055	0.0065	0.0065	0.0075	0.0080	0.0080	120
N1	M	0,38	0,42	0,46	0,50	0,55	0,55	305
	M	0.015	0.017	0.018	0.020	0.022	0.022	1000
N2	M	0,38	0,42	0,46	0,50	0,55	0,55	195
	M	0.015	0.017	0.018	0.020	0.022	0.022	640
N3	M	0,38	0,42	0,46	0,50	0,55	0,55	130
	M	0.015	0.017	0.018	0.020	0.022	0.022	425
N11	M	0,38	0,42	0,46	0,50	0,55	0,55	250
	M	0.015	0.017	0.018	0.020	0.022	0.022	820
S1	M	0,11	0,13	0,15	0,16	0,17	0,19	34
	M	0.0044	0.0050	0.0060	0.0065	0.0065	0.0075	110
S2	M	0,11	0,13	0,15	0,16	0,17	0,19	25
	M	0.0044	0.0050	0.0060	0.0065	0.0065	0.0075	80
S3	M	0,11	0,13	0,15	0,16	0,17	0,19	25
	M	0.0044	0.0050	0.0060	0.0065	0.0065	0.0075	80
S11	M	0,17	0,19	0,22	0,24	0,25	0,26	65
	M	0.0065	0.0075	0.0085	0.0095	0.010	0.010	215
S12	M	0,17	0,19	0,22	0,24	0,25	0,26	49
	M	0.0065	0.0075	0.0085	0.0095	0.010	0.010	160
S13	M	0,15	0,17	0,19	0,20	0,22	0,22	38
	M	0.0060	0.0065	0.0075	0.0080	0.0085	0.0085	125

SMG = Gruppo materiale Seco

f = mm/giro

v_c = m/min

Tutti i parametri di taglio sono valori di partenza

Introduzione

Foratura

Alesatura

Barenatura

Allegato

SMG		f						v _c
		Ø 3,00 Ø 0.118	Ø 5,00 Ø 0.197	Ø 7,00 Ø 0.276	Ø 9,00 Ø 0.354	Ø 11,00 Ø 0.433	Ø 13,00 Ø 0.512	
TS2	C1	0,060	0,060	0,065	0,070	0,075	0,080	65
	C1	0.0024	0.0024	0.0026	0.0028	0.0030	0.0032	215
TS3	C1	0,060	0,060	0,065	0,070	0,075	0,080	50
	C1	0.0024	0.0024	0.0026	0.0028	0.0030	0.0032	165
TP2	C1	0,060	0,060	0,065	0,070	0,075	0,080	65
	C1	0.0024	0.0024	0.0026	0.0028	0.0030	0.0032	215
TP3	C1	0,060	0,060	0,065	0,070	0,075	0,080	50
	C1	0.0024	0.0024	0.0026	0.0028	0.0030	0.0032	165

SMG		f						v _c
		Ø 3,00 Ø 0.118	Ø 5,00 Ø 0.197	Ø 7,00 Ø 0.276	Ø 9,00 Ø 0.354	Ø 11,00 Ø 0.433	Ø 13,00 Ø 0.512	
N1	C2	0,095	0,10	0,11	0,12	0,13	0,14	80
	C2	0.0038	0.0040	0.0044	0.0048	0.0050	0.0055	260
N2	C2	0,095	0,10	0,11	0,12	0,13	0,14	50
	C2	0.0038	0.0040	0.0044	0.0048	0.0050	0.0055	165
N3	C2	0,095	0,10	0,11	0,12	0,13	0,14	33
	C2	0.0038	0.0040	0.0044	0.0048	0.0050	0.0055	110
S11	C2	0,055	0,065	0,080	0,090	0,10	0,11	50
	C2	0.0022	0.0026	0.0032	0.0036	0.0040	0.0044	165
S12	C2	0,055	0,065	0,080	0,090	0,10	0,11	40
	C2	0.0022	0.0026	0.0032	0.0036	0.0040	0.0044	130
S13	C2	0,048	0,060	0,070	0,080	0,090	0,10	31
	C2	0.0019	0.0024	0.0028	0.0032	0.0036	0.0040	100

SMG		f				v _c
		Ø 3,00 Ø 0.118	Ø 5,00 Ø 0.197	Ø 7,00 Ø 0.276	Ø 9,00 Ø 0.354	
TS2	CX1	0,075	0,085	0,090	0,10	150
	CX1	0.0030	0.0034	0.0036	0.0040	490
TS3	CX1	0,075	0,085	0,090	0,10	120
	CX1	0.0030	0.0034	0.0036	0.0040	395
TP2	CX1	0,075	0,085	0,090	0,10	150
	CX1	0.0030	0.0034	0.0036	0.0040	490
TP3	CX1	0,075	0,085	0,090	0,10	120
	CX1	0.0030	0.0034	0.0036	0.0040	395

SMG = Gruppo materiale Seco

f = mm/giro

v_c = m/min

Tutti i parametri di taglio sono valori di partenza

Foratura

Seco Universal™ – Parametri di taglio



SD22 & SD26 – Ø 0,1-0,3 mm / 0.0039-0.0118 pollici

SMG	f			V _c
	Ø 0,10 Ø 0.0039	Ø 0,20 Ø 0.0079	Ø 0,30 Ø 0.0118	
P1	0,0011	0,0017	0,0024	11
	0.000044	0.000065	0.000095	36
P2	0,0011	0,0017	0,0024	11
	0.000044	0.000065	0.000095	36
P3	0,0010	0,0016	0,0022	10
	0.000040	0.000065	0.000085	33
P4	0,0010	0,0016	0,0022	8
	0.000040	0.000065	0.000085	26
P5	0,0010	0,0016	0,0022	8
	0.000040	0.000065	0.000085	26
P6	0,0010	0,0016	0,0022	9
	0.000040	0.000065	0.000085	30
P7	0,0010	0,0016	0,0022	8
	0.000040	0.000065	0.000085	26
P8	0,0010	0,0016	0,0022	8
	0.000040	0.000065	0.000085	26
P11	0,0010	0,0016	0,0022	8
	0.000040	0.000065	0.000085	26
P12	0,00070	0,0011	0,0015	5
	0.000028	0.000044	0.000060	16
M1	0,0011	0,0017	0,0024	2
	0.000044	0.000065	0.000095	7
M2	0,0010	0,0016	0,0022	2
	0.000040	0.000065	0.000085	7
K1	0,0011	0,0017	0,0024	6
	0.000044	0.000065	0.000095	20
K2	0,0010	0,0016	0,0022	5
	0.000040	0.000065	0.000085	16
K3	0,0010	0,0016	0,0022	4
	0.000040	0.000065	0.000085	13
K4	0,0010	0,0016	0,0022	4
	0.000040	0.000065	0.000085	13
K5	0,00090	0,0014	0,0019	3
	0.000036	0.000055	0.000075	10
N2	0,0014	0,0022	0,0030	15
	0.000055	0.000085	0.00012	49
N3	0,0014	0,0022	0,0030	10
	0.000055	0.000085	0.00012	33
S11	0,00080	0,0013	0,0017	4
	0.000032	0.000050	0.000065	13
S12	0,00080	0,0013	0,0017	3
	0.000032	0.000050	0.000065	10

SMG = Gruppo materiale Seco

f = mm/giro

V_c = m/min

Tutti i parametri di taglio sono valori di partenza

Introduzione

Foratura

Alesatura

Barenatura

Allegato

SMG	f		v _c
	Ø 0,40 Ø 0.0157	Ø 0,50 Ø 0.0197	
P1	0,0030	0,0036	14
	0.00012	0.00014	46
P2	0,0030	0,0036	14
	0.00012	0.00014	46
P3	0,0028	0,0034	12
	0.00011	0.00013	39
P4	0,0028	0,0034	10
	0.00011	0.00013	33
P5	0,0028	0,0034	10
	0.00011	0.00013	33
P6	0,0028	0,0032	11
	0.00011	0.00013	36
P7	0,0028	0,0032	11
	0.00011	0.00013	36
P8	0,0028	0,0034	10
	0.00011	0.00013	33
P11	0,0028	0,0032	10
	0.00011	0.00013	33
P12	0,0019	0,0022	6
	0.000075	0.000085	20
M1	0,0030	0,0036	5
	0.00012	0.00014	16
M2	0,0028	0,0034	4
	0.00011	0.00013	13
K1	0,0030	0,0036	10
	0.00012	0.00014	33
K2	0,0028	0,0034	9
	0.00011	0.00013	30
K3	0,0028	0,0034	7
	0.00011	0.00013	23
K4	0,0028	0,0034	7
	0.00011	0.00013	23
K5	0,0025	0,0030	4
	0.00010	0.00012	13
N2	0,0038	0,0046	30
	0.00015	0.00018	100
N3	0,0038	0,0046	20
	0.00015	0.00018	65
S11	0,0022	0,0026	8
	0.000085	0.00010	26
S12	0,0022	0,0026	6
	0.000085	0.00010	20

SMG = Gruppo materiale Seco
 f = mm/giro
 v_c = m/min
 Tutti i parametri di taglio sono valori di partenza

Introduzione

Foratura

Alesatura

Barenatura

Allegato

Foratura

Seco Universal™ – Parametri di taglio



SD22 & SD26 – Ø 0,6-0,8 mm / 0.0236-0.0315 pollici

SMG	f			V _c
	Ø 0,60 Ø 0.0236	Ø 0,70 Ø 0.0276	Ø 0,80 Ø 0.0315	
P1	0,0042	0,0048	0,0055	28
	0.00017	0.00019	0.00022	90
P2	0,0042	0,0050	0,0055	28
	0.00017	0.00020	0.00022	90
P3	0,0040	0,0046	0,0055	24
	0.00016	0.00018	0.00022	80
P4	0,0040	0,0046	0,0050	21
	0.00016	0.00018	0.00020	70
P5	0,0038	0,0044	0,0050	20
	0.00015	0.00017	0.00020	65
P6	0,0038	0,0044	0,0050	22
	0.00015	0.00017	0.00020	70
P7	0,0038	0,0044	0,0050	21
	0.00015	0.00017	0.00020	70
P8	0,0040	0,0046	0,0055	20
	0.00016	0.00018	0.00022	65
P11	0,0038	0,0044	0,0050	21
	0.00015	0.00017	0.00020	70
P12	0,0026	0,0030	0,0034	12
	0.00010	0.00012	0.00013	39
M1	0,0042	0,0050	0,0055	9
	0.00017	0.00020	0.00022	30
M2	0,0038	0,0044	0,0050	7
	0.00015	0.00017	0.00020	23
K1	0,0042	0,0050	0,0055	15
	0.00017	0.00020	0.00022	49
K2	0,0038	0,0044	0,0050	13
	0.00015	0.00017	0.00020	43
K3	0,0038	0,0044	0,0050	11
	0.00015	0.00017	0.00020	36
K4	0,0038	0,0044	0,0050	10
	0.00015	0.00017	0.00020	33
K5	0,0036	0,0040	0,0046	6
	0.00014	0.00016	0.00018	20
N2	0,0055	0,0065	0,0070	60
	0.00022	0.00026	0.00028	195
N3	0,0055	0,0065	0,0070	40
	0.00022	0.00026	0.00028	130
S11	0,0032	0,0036	0,0040	13
	0.00013	0.00014	0.00016	43
S12	0,0032	0,0036	0,0040	10
	0.00013	0.00014	0.00016	33

SMG = Gruppo materiale Seco

f = mm/giro

V_c = m/min

Tutti i parametri di taglio sono valori di partenza

Introduzione

Foratura

Alesatura

Barenatura

Allegato

SMG	f			V _c
	Ø 0,90 Ø 0.0354	Ø 1,00 Ø 0.0394	Ø 1,10 Ø 0.0433	
P1	0,0060	0,0065	0,0075	50
	0.00024	0.00026	0.00030	165
P2	0,0060	0,0070	0,0075	48
	0.00024	0.00028	0.00030	155
P3	0,0060	0,0065	0,0070	42
	0.00024	0.00026	0.00028	140
P4	0,0055	0,0065	0,0070	37
	0.00022	0.00026	0.00028	120
P5	0,0055	0,0060	0,0070	35
	0.00022	0.00024	0.00028	115
P6	0,0055	0,0060	0,0065	39
	0.00022	0.00024	0.00026	130
P7	0,0055	0,0060	0,0065	37
	0.00022	0.00024	0.00026	120
P8	0,0060	0,0065	0,0070	35
	0.00024	0.00026	0.00028	115
P11	0,0055	0,0060	0,0065	36
	0.00022	0.00024	0.00026	120
P12	0,0038	0,0042	0,0046	21
	0.00015	0.00017	0.00018	70
M1	0,0060	0,0070	0,0075	12
	0.00024	0.00028	0.00030	39
M2	0,0055	0,0060	0,0070	10
	0.00022	0.00024	0.00028	33
K1	0,0060	0,0070	0,0075	20
	0.00024	0.00028	0.00030	65
K2	0,0055	0,0060	0,0070	17
	0.00022	0.00024	0.00028	55
K3	0,0055	0,0060	0,0070	15
	0.00022	0.00024	0.00028	49
K4	0,0055	0,0060	0,0070	14
	0.00022	0.00024	0.00028	46
K5	0,0050	0,0055	0,0060	8
	0.00020	0.00022	0.00024	26
N2	0,0080	0,0085	0,0095	80
	0.00032	0.00034	0.00038	260
N3	0,0080	0,0085	0,0095	55
	0.00032	0.00034	0.00038	180
S11	0,0046	0,0050	0,0055	19
	0.00018	0.00020	0.00022	60
S12	0,0046	0,0050	0,0055	15
	0.00018	0.00020	0.00022	49

SMG = Gruppo materiale Seco
 f = mm/giro
 V_c = m/min
 Tutti i parametri di taglio sono valori di partenza

Introduzione
 Foratura
 Alesatura
 Barenatura
 Allegato

Foratura

Seco Universal™ – Parametri di taglio



SD22 & SD26 – Ø 1,2-2,0 mm / 0.0472-0.0787 pollici

SMG	f					V _c
	Ø 1,20 Ø 0.0472	Ø 1,40 Ø 0.0551	Ø 1,60 Ø 0.0630	Ø 1,80 Ø 0.0709	Ø 2,00 Ø 0.0787	
P1	0,0080	0,0090	0,010	0,012	0,013	70
	0,00032	0,00036	0,00040	0,00048	0,00050	230
P2	0,0080	0,0095	0,011	0,012	0,013	70
	0,00032	0,00038	0,00044	0,00048	0,00050	230
P3	0,0075	0,0090	0,010	0,011	0,012	60
	0,00030	0,00036	0,00040	0,00044	0,00048	195
P4	0,0075	0,0085	0,010	0,011	0,012	50
	0,00030	0,00034	0,00040	0,00044	0,00048	165
P5	0,0075	0,0085	0,0095	0,011	0,012	50
	0,00030	0,00034	0,00038	0,00044	0,00048	165
P6	0,0075	0,0085	0,0095	0,011	0,012	55
	0,00030	0,00034	0,00038	0,00044	0,00048	180
P7	0,0075	0,0085	0,0095	0,011	0,012	55
	0,00030	0,00034	0,00038	0,00044	0,00048	180
P8	0,0075	0,0090	0,010	0,011	0,012	50
	0,00030	0,00036	0,00040	0,00044	0,00048	165
P11	0,0075	0,0085	0,0095	0,011	0,012	50
	0,00030	0,00034	0,00038	0,00044	0,00048	165
P12	0,0050	0,0060	0,0065	0,0075	0,0080	30
	0,00020	0,00024	0,00026	0,00030	0,00032	100
M1	0,0080	0,0095	0,011	0,012	0,013	15
	0,00032	0,00038	0,00044	0,00048	0,00050	49
M2	0,0075	0,0085	0,0095	0,011	0,012	12
	0,00030	0,00034	0,00038	0,00044	0,00048	39
K1	0,0080	0,0095	0,011	0,012	0,013	35
	0,00032	0,00038	0,00044	0,00048	0,00050	115
K2	0,0075	0,0085	0,0095	0,011	0,012	30
	0,00030	0,00034	0,00038	0,00044	0,00048	100
K3	0,0075	0,0085	0,0095	0,011	0,012	26
	0,00030	0,00034	0,00038	0,00044	0,00048	85
K4	0,0075	0,0085	0,0095	0,011	0,012	25
	0,00030	0,00034	0,00038	0,00044	0,00048	80
K5	0,0065	0,0075	0,0085	0,010	0,011	15
	0,00026	0,00030	0,00034	0,00040	0,00044	49
N2	0,010	0,012	0,014	0,015	0,017	100
	0,00040	0,00048	0,00055	0,00060	0,00065	330
N3	0,010	0,012	0,014	0,015	0,017	65
	0,00040	0,00048	0,00055	0,00060	0,00065	215
S11	0,0060	0,0070	0,0075	0,0085	0,0095	26
	0,00024	0,00028	0,00030	0,00034	0,00038	85
S12	0,0060	0,0070	0,0075	0,0085	0,0095	20
	0,00024	0,00028	0,00030	0,00034	0,00038	65

SMG = Gruppo materiale Seco

f = mm/giro

V_c = m/min

Tutti i parametri di taglio sono valori di partenza

Introduzione

Foratura

Alesatura

Barenatura

Allegato



Seco Crownloc®

Seco Crownloc® è una gamma di punte con corona intercambiabile, indicata per effettuare fori di elevata qualità ad un costo inferiore. L'intercambiabilità delle corone della gamma Crownloc, unita all'alta precisione delle punte, consente di eliminare la necessità di riaffilature e i relativi costi.

- Due fori per il refrigerante attraverso la corona consentono il passaggio di una grande quantità di liquido diretto ai taglienti.
- Crownloc® è disponibile in una vasta scelta di geometrie della corona ottimizzate per diverse applicazioni e materiali da lavorare.

Panoramica della gamma

Crownloc®	Gamma Ø	Profondità di foratura	Tolleranza Ø punta	Tolleranza foro (1)	Finitura superficiale (2)
<p>SD101</p>  <p>Pagine 175-176</p>	12,00-25,99 mm (0.472-1.023")	1,5 x D	k7	IT 10	Ra 1-3 µm (Ra 39-118 µin)
<p>SD103</p>  <p>Pagine 177-178</p>	9,52-25,99 mm (0.375-1.023")	3 x D	k7	IT 10	Ra 1-3 µm (Ra 39-118 µin)
<p>SD105</p>  <p>Pagine 179-180</p>	10,00-25,99 mm (0.394-1.023")	5 x D	k7	IT 10	Ra 1-3 µm (Ra 39-118 µin)
<p>SD107</p>  <p>Pagine 181-182</p>	12,00-25,99 mm (0.472-1.023")	7 x D	k7	IT 10	Ra 1-4 µm (Ra 39-157 µin)
<p>Modulo per smussi</p>  <p>Pagine 190</p>	12,00-19,99 mm (0.472-0.787")	-	-	-	-

1) Possono verificarsi variazioni a seconda del materiale da lavorare e dei parametri di taglio utilizzati.

2) La profondità di foratura, i parametri di taglio, la pressione del refrigerante e il materiale da lavorare possono causare il deterioramento della finitura superficiale.

Chiavi di codifica

Chiave di codifica corpi punta

Misure metriche

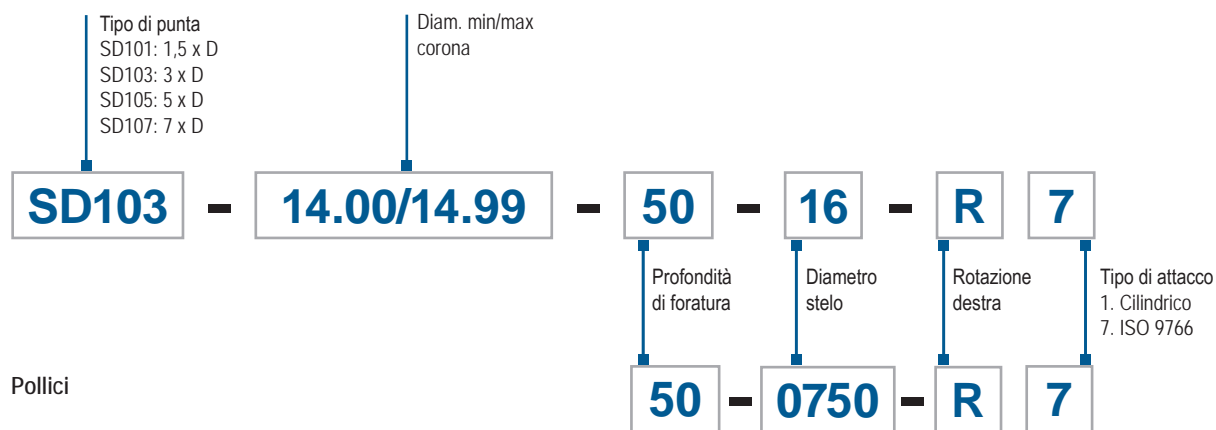

Corone chiavi di codifica



Geometrie

Geometria -P
- Geometria universale, prima scelta per foratura di acciaio



Geometria -M
- Per acciaio inossidabile e leghe per alte temperature



Geometria K
- Prima scelta per foratura di ghisa



Kit ricambi

Diametro punta mm (Pollici)	SD101	SD103	SD105	SD107
10,00-11,99	-	SD103-SP-4.0	SD105-SP-4.0	-
12,00-13,99	SD101-SP-5.0	SD103-SP-5.0	SD105-SP-5.0	SD107-SP-5.0
14,00-16,99	SD101-SP-6.0	SD103-SP-6.0	SD105-SP-6.0	SD107-SP-6.0
17,00-19,99	SD101-SP-7.0	SD103-SP-7.0	SD105-SP-7.0	SD107-SP-7.0
20,00-25,99	SD101-SP-8.0	SD103-SP-8.0	SD105-SP-8.0	SD107-SP-8.0

Istruzioni di montaggio

1. Pulire accuratamente la superficie di contatto del corpo punta in modo da rimuovere eventuali trucioli o impurità.
2. Assicurarsi che il tirante sia completamente a fondo corsa.
3. Montare la nuova corona sul tirante ed avvitarela fino a che raggiunge il fondo del filetto.

Ruotare leggermente la corona in senso antiorario (in senso opposto) allineando le superfici di accoppiamento.

Mettere in contatto la corona con il corpo punta ed agire sulla vite di serraggio. Assicurarsi del perfetto accoppiamento delle due parti.

Stringere bene la vite di bloccaggio usando la chiave dinamometrica.

Stabilità

La stabilità dell'applicazione è fondamentale per avere lunghe durate e finiture ottimali dei fori. Controllare le condizioni del mandrino macchina, il fissaggio e lo staffaggio dei componenti per assicurare la massima rigidità e stabilità. Condizioni di lavoro poco stabili possono causare la rottura dell'utensile.

Applicazioni rotanti

Nelle applicazioni rotanti, il TIR (Totally Indicated Run-out) non dovrebbe eccedere 0,06 mm (0,002"). Misurare l'eccentricità quando la punta è montata sul mandrino.

1.

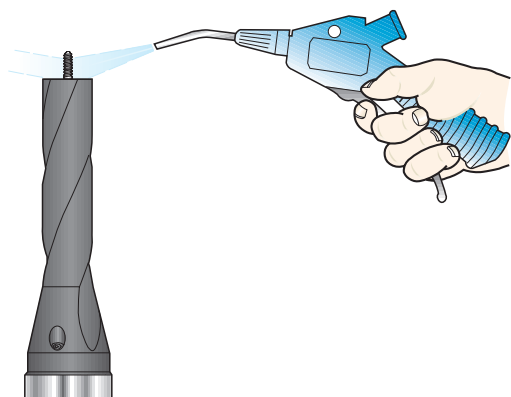

2.

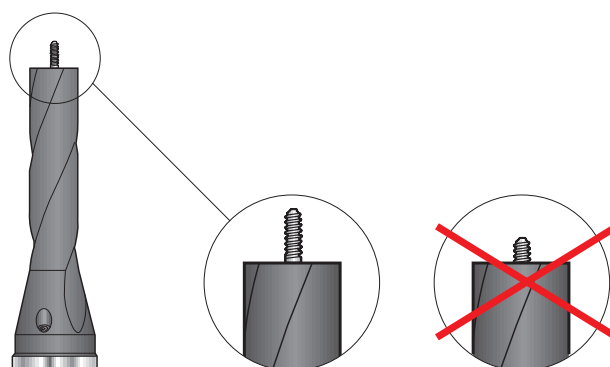

3.



Applicazioni non rotanti

Nelle applicazioni non rotanti, la distanza tra l'asse della punta e il centro di rotazione del pezzo non dovrebbe eccedere 0,03 mm (0,001") radialmente.

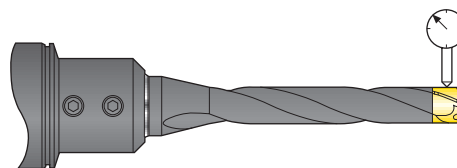

Attacchi consigliati

Per garantire i migliori risultati, utilizzare attacchi del tipo DIN 1835 B/DIN 6535 HB (Weldon). Per ulteriori informazioni, vedere il catalogo Utensili.



Weldon

Ø Punta DC mm	M _c Nm	Ø Punta DC pollici	M _c in/lbs
10,00-13,99	0,8-1,0	0.394-0.551	7-9
14,00-16,99	1,8-2,2	0.551-0.669	16-19.5
17,00-25,99	2,5-3,0	0.669-1.023	22-26

SD101 – R7

Profondità di foratura ~ 1,5 x D – Codolo metrico

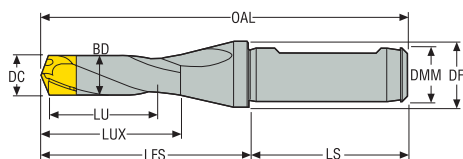

- Adduzione refrigerante interna
- ISO9766 per attacchi: Weldon 1835B, ISO 5414, DIN 60880
- Per i parametri di taglio raccomandati, vedere pagina(e) 193

Codice di ordinazione	Codice prodotto	DC	LU	OAL	LUX	BD	LFS	LS	DMM	DF
		mm	mm	mm	mm	mm	mm	mm	mm	mm
SD101-12.00/12.49-20-16R7	02445790	12,0-12,49	20,0	96,0	32,0	11,5	48,0	48,0	16,0	20,0
SD101-12.50/12.99-20-16R7	02445791	12,5-12,99	20,0	96,4	32,4	12,0	48,4	48,0	16,0	20,0
SD101-13.00/13.99-20-16R7	02445792	13,0-13,99	20,0	96,8	32,8	12,5	48,8	48,0	16,0	20,0
SD101-14.00/14.99-25-16R7	02445793	14,0-14,99	25,0	102,4	38,4	13,5	54,4	48,0	16,0	20,0
SD101-15.00/15.99-25-16R7	02445794	15,0-15,99	25,0	103,3	39,3	14,5	55,3	48,0	16,0	20,0
SD101-16.00/16.99-25-16R7	02445795	16,0-16,99	25,0	104,0	40,0	15,5	56,0	48,0	16,0	20,0
SD101-17.00/17.99-30-20R7	02445796	17,0-17,99	30,0	110,7	44,7	16,5	60,7	50,0	20,0	25,0
SD101-18.00/18.99-30-20R7	02445797	18,0-18,99	30,0	111,7	45,7	17,5	61,7	50,0	20,0	25,0
SD101-19.00/19.99-30-20R7	02445798	19,0-19,99	30,0	112,5	46,5	18,5	62,5	50,0	20,0	25,0
SD101-20.00/21.99-40-25R7	02462832	20,0-21,99	40,0	129,5	53,5	19,5	73,5	56,0	25,0	31,0
SD101-22.00/23.99-40-25R7	02462833	22,0-23,99	40,0	129,5	53,5	21,5	73,5	56,0	25,0	31,0
SD101-24.00/25.99-40-25R7	02462834	24,0-25,99	40,0	129,5	53,5	23,5	73,5	56,0	25,0	31,0

Parti di ricambio, comprese nella fornitura

Per punta diametro (mm)	Chiave di bloccaggio	Vite di bloccaggio	Kit parti di ricambio
12,00-13,99	H1.5-2D	MP6SS3X12	SD101-SP-5.0
14,00-16,99	H2.0-2D	MP6SS4X12	SD101-SP-6.0
17,00-19,99	H2.5-2D	MP6SS5X16	SD101-SP-7.0
20,00-25,99	H2.5-2D	MP6SS5X16	SD101-SP-8.0

Accessori

Bit	Chiave dinamometrica
H00-1.5	H00-1509
H00-2.0	H00-2020
H00-2.5	H00-2530
H00-2.5	H00-2535

Introduzione

Foratura

Alesatura

Barenatura

Allegato

SD101 – R7

Profondità di foratura ~ 1,5 x D – Codolo in pollici

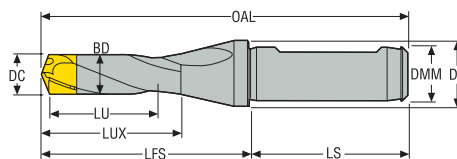

- Adduzione refrigerante interna
- ISO9766 per attacchi: Weldon 1835B, ISO 5414, DIN 60880
- Per i parametri di taglio raccomandati, vedere pagina(e) 193

Codice di ordinazione	Codice prodotto	DC	LU	BD	DF	OAL	LS	LFS	LUX	DMM
		Inch	Inch	Inch	Inch	Inch	Inch	Inch	Inch	Inch
SD101-12.00/12.49-20-0625R7	02445817	0.472-0.492	0.787	0.453	0.787	3.780	1.890	1.890	1.260	0.625
SD101-12.50/12.99-20-0625R7	02445818	0.492-0.511	0.787	0.472	0.787	3.795	1.890	1.906	1.276	0.625
SD101-13.00/13.99-20-0625R7	02445819	0.512-0.551	0.787	0.492	0.787	3.811	1.890	1.921	1.291	0.625
SD101-14.00/14.99-25-0625R7	02445820	0.551-0.590	0.984	0.531	0.787	4.031	1.890	2.142	1.512	0.625
SD101-15.00/15.99-25-0625R7	02445821	0.591-0.630	0.984	0.571	0.787	4.067	1.890	2.177	1.547	0.625
SD101-16.00/16.99-25-0625R7	02445822	0.630-0.669	0.984	0.610	0.787	4.094	1.890	2.205	1.575	0.625
SD101-17.00/17.99-30-0750R7	02445823	0.669-0.708	1.181	0.650	0.984	4.358	1.969	2.390	1.760	0.750
SD101-18.00/18.99-30-0750R7	02445824	0.709-0.748	1.181	0.689	0.984	4.398	1.969	2.429	1.799	0.750
SD101-19.00/19.99-30-0750R7	02445825	0.748-0.787	1.181	0.728	0.984	4.429	1.969	2.461	1.831	0.750
SD101-20.00/21.99-40-1000R7	02466044	0.787-0.866	1.575	0.768	1.220	5.098	2.205	2.894	2.106	1.000
SD101-22.00/23.99-40-1000R7	02466045	0.866-0.944	1.575	0.846	1.220	5.098	2.205	2.894	2.106	1.000
SD101-24.00/25.99-40-1000R7	02466046	0.945-1.023	1.575	0.925	1.220	5.098	2.205	2.894	2.106	1.000

Parti di ricambio, comprese nella fornitura

Per punta diametro (pollici)	Chiave di bloccaggio	Vite di bloccaggio	Kit parti di ricambio
0.472-0.551	H1.5-2D	MP6SS3X12	SD101-SP-5.0
0.551-0.669	H2.0-2D	MP6SS4X12	SD101-SP-6.0
0.669-0.787	H2.5-2D	MP6SS5X16	SD101-SP-7.0
0.787-1.023	H2.5-2D	MP6SS5X16	SD101-SP-8.0

Accessori

Bit	Chiave dinamometrica
H00-1.5	H00-1509
H00-2.0	H00-2020
H00-2.5	H00-2530
H00-2.5	H00-2535

Introduzione

Foratura

Alesatura

Barenatura

Allegato

SD103 – R7

Profondità di foratura ~ 3 x D – Codolo metrico

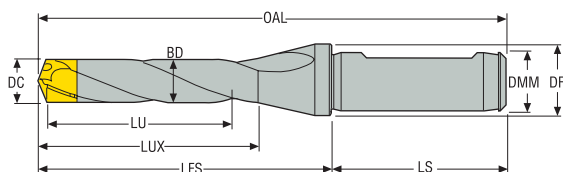

- Adduzione refrigerante interna
- ISO9766 per attacchi: Weldon 1835B, ISO 5414, DIN 60880
- Per i parametri di taglio raccomandati, vedere pagina(e) 194

Codice di ordinazione	Codice prodotto	DC	LU	OAL	LUX	BD	LFS	LS	DMM	DF
		mm	mm	mm	mm	mm	mm	mm	mm	mm
SD103-10.00/10.49-30-16R7	02462815	10,0-10,49	30,0	101,0	38,0	9,5	53,0	48,0	16,0	20,0
SD103-10.50/10.99-30-16R7	02462818	10,5-10,99	30,0	101,0	38,0	10,0	53,0	48,0	16,0	20,0
SD103-11.00/11.49-30-16R7	02462819	11,0-11,49	30,0	101,0	38,0	10,5	53,0	48,0	16,0	20,0
SD103-11.50/11.99-30-16R7	02462820	11,5-11,99	30,0	101,0	38,0	11,0	53,0	48,0	16,0	20,0
SD103-12.00/12.49-40-16R7	02445799	12,0-12,49	40,0	116,0	48,0	11,5	68,0	48,0	16,0	20,0
SD103-12.50/12.99-40-16R7	02445800	12,5-12,99	40,0	116,4	48,4	12,0	68,4	48,0	16,0	20,0
SD103-13.00/13.99-40-16R7	02445801	13,0-13,99	40,0	116,8	48,8	12,5	68,8	48,0	16,0	20,0
SD103-14.00/14.99-50-16R7	02445802	14,0-14,99	50,0	127,4	59,4	13,5	79,4	48,0	16,0	20,0
SD103-15.00/15.99-50-16R7	02445803	15,0-15,99	50,0	128,3	60,3	14,5	80,3	48,0	16,0	20,0
SD103-16.00/16.99-50-16R7	02445804	16,0-16,99	50,0	129,0	61,0	15,5	81,0	48,0	16,0	20,0
SD103-17.00/17.99-60-20R7	02445805	17,0-17,99	60,0	140,7	67,7	16,5	90,7	50,0	20,0	25,0
SD103-18.00/18.99-60-20R7	02445806	18,0-18,99	60,0	141,7	68,7	17,5	91,7	50,0	20,0	25,0
SD103-19.00/19.99-60-20R7	02445807	19,0-19,99	60,0	142,5	69,5	18,5	92,7	50,0	20,0	25,0
SD103-20.00/21.99-75-25R7	02462836	20,0-21,99	75,0	164,5	88,5	19,5	108,5	56,0	25,0	31,0
SD103-22.00/23.99-75-25R7	02462838	22,0-23,99	75,0	164,5	88,5	21,5	108,5	56,0	25,0	31,0
SD103-24.00/25.99-75-25R7	02462841	24,0-25,99	75,0	164,5	88,5	23,5	108,5	56,0	25,0	31,0

Parti di ricambio, comprese nella fornitura

Per punta diametro (mm)	Chiave di bloccaggio	Vite di bloccaggio	Kit parti di ricambio
10,00-11,99	H1.5-2D	MP6SS3X12	SD103-SP-4.0
12,00-13,99	H1.5-2D	MP6SS3X12	SD103-SP-5.0
14,00-16,99	H2.0-2D	MP6SS4X12	SD103-SP-6.0
17,00-19,99	H2.5-2D	MP6SS5X16	SD103-SP-7.0
20,00-25,99	H2.5-2D	MP6SS5X16	SD103-SP-8.0

Accessori

Bit	Chiave dinamometrica
H00-1.5	H00-1509
H00-1.5	H00-1509
H00-2.0	H00-2020
H00-2.5	H00-2530
H00-2.5	H00-2535

Introduzione

Foratura

Alesatura

Barenatura

Allegato

SD103 – R7

Profondità di foratura ~ 3 x D – Codolo in pollici

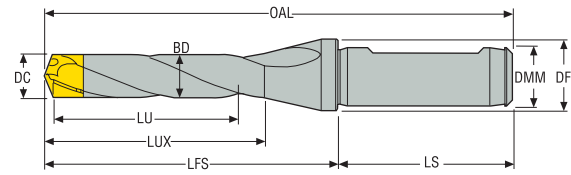

- Adduzione refrigerante interna
- ISO9766 per attacchi: Weldon 1835B, ISO 5414, DIN 60880
- Per i parametri di taglio raccomandati, vedere pagina(e) 194

Codice di ordinazione	Codice prodotto	DC	LU	BD	DF	OAL	LS	LFS	LUX	DMM
		Inch	Inch	Inch	Inch	Inch	Inch	Inch	Inch	Inch
SD103-09.50/09.99-30-0625R7	02673828	0.374-0.393	1.181	0.354	0.787	4.252	1.969	2.323	1.835	0.625
SD103-10.00/10.49-30-0625R7	02466011	0.394-0.413	1.181	0.374	0.787	3.976	1.890	2.087	1.496	0.625
SD103-10.50/10.99-30-0625R7	02466012	0.413-0.433	1.181	0.394	0.787	3.976	1.890	2.087	1.496	0.625
SD103-11.00/11.49-30-0625R7	02466013	0.433-0.452	1.181	0.413	0.787	3.976	1.890	2.087	1.496	0.625
SD103-11.50/11.99-30-0625R7	02466014	0.453-0.472	1.181	0.433	0.787	3.976	1.890	2.087	1.496	0.625
SD103-12.00/12.49-40-0625R7	02445826	0.472-0.492	1.575	0.453	0.787	4.567	1.890	2.677	1.890	0.625
SD103-12.50/12.99-40-0625R7	02445827	0.492-0.511	1.575	0.472	0.787	4.583	1.890	2.693	1.906	0.625
SD103-13.00/13.99-40-0625R7	02445828	0.512-0.551	1.575	0.492	0.787	4.598	1.890	2.709	1.921	0.625
SD103-14.00/14.99-50-0625R7	02445829	0.551-0.590	1.969	0.531	0.787	5.016	1.890	3.126	2.339	0.625
SD103-15.00/15.99-50-0625R7	02445830	0.591-0.630	1.969	0.571	0.787	5.051	1.890	3.161	2.374	0.625
SD103-16.00/16.99-50-0625R7	02445831	0.630-0.669	1.969	0.610	0.787	5.079	1.890	3.189	2.402	0.625
SD103-17.00/17.99-60-0750R7	02445832	0.669-0.708	2.362	0.650	0.984	5.539	1.969	3.571	2.665	0.750
SD103-18.00/18.99-60-0750R7	02445833	0.709-0.748	2.362	0.689	0.984	5.579	1.969	3.610	2.705	0.750
SD103-19.00/19.99-60-0750R7	02445834	0.748-0.787	2.362	0.728	0.984	5.610	1.969	3.650	2.736	0.750
SD103-20.00/21.99-75-1000R7	02466049	0.787-0.866	2.953	0.768	1.220	6.476	2.205	4.272	3.484	1.000
SD103-22.00/23.99-75-1000R7	02466050	0.866-0.944	2.953	0.846	1.220	6.476	2.205	4.272	3.484	1.000
SD103-24.00/25.99-75-1000R7	02466051	0.945-1.023	2.953	0.925	1.220	6.476	2.205	4.272	3.484	1.000

Parti di ricambio, comprese nella fornitura

Per punta diametro (pollici)	Chiave di bloccaggio	Vite di bloccaggio	Kit parti di ricambio
0.374-0.393	H1.5-2D	MP6SS3X12	-
0.394-0.472	H1.5-2D	MP6SS3X12	SD103-SP-4.0
0.472-0.551	H1.5-2D	MP6SS3X12	SD103-SP-5.0
0.551-0.669	H2.0-2D	MP6SS4X12	SD103-SP-6.0
0.669-0.787	H2.5-2D	MP6SS5X16	SD103-SP-7.0
0.787-1.023	H2.5-2D	MP6SS5X16	SD103-SP-8.0

Accessori

Bit	Chiave dinamometrica
H00-1.5	H00-1509
H00-1.5	H00-1509
H00-1.5	H00-1509
H00-2.0	H00-2020
H00-2.5	H00-2530
H00-2.5	H00-2535

SD105 – R7

Profondità di foratura ~ 5 x D – Codolo metrico

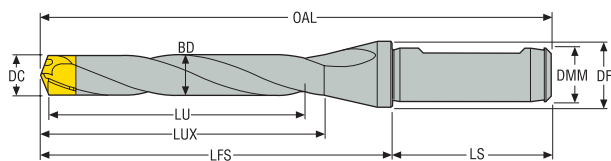

- Adduzione refrigerante interna
- ISO9766 per attacchi: Weldon 1835B, ISO 5414, DIN 60880
- Per i parametri di taglio raccomandati, vedere pagina(e) 195

Codice di ordinazione	Codice prodotto	DC	LU	OAL	LUX	BD	LFS	LS	DMM	DF
		mm	mm	mm	mm	mm	mm	mm	mm	mm
SD105-10.00/10.49-50-16R7	02462822	10,0-10,49	50,0	120,1	57,3	9,5	72,1	48,0	16,0	20,0
SD105-10.50/10.99-50-16R7	02462824	10,5-10,99	50,0	120,6	57,3	10,0	72,6	48,0	16,0	20,0
SD105-11.00/11.49-50-16R7	02462828	11,0-11,49	50,0	120,9	57,3	10,5	72,9	48,0	16,0	20,0
SD105-11.50/11.99-50-16R7	02462830	11,5-11,99	50,0	121,3	58,3	11,0	73,3	48,0	16,0	20,0
SD105-12.00/12.49-65-16R7	02445808	12,0-12,49	65,0	141,0	73,0	11,5	93,0	48,0	16,0	20,0
SD105-12.50/12.99-65-16R7	02445809	12,5-12,99	65,0	141,4	73,4	12,0	93,4	48,0	16,0	20,0
SD105-13.00/13.99-65-16R7	02445810	13,0-13,99	65,0	141,8	73,8	12,5	93,8	48,0	16,0	20,0
SD105-14.00/14.99-80-16R7	02445811	14,0-14,99	80,0	157,4	89,4	13,5	109,4	48,0	16,0	20,0
SD105-15.00/15.99-80-16R7	02445812	15,0-15,99	80,0	158,3	90,3	14,5	110,3	48,0	16,0	20,0
SD105-16.00/16.99-80-16R7	02445813	16,0-16,99	80,0	159,0	91,0	15,5	111,0	48,0	16,0	20,0
SD105-17.00/17.99-95-20R7	02445814	17,0-17,99	95,0	176,7	107,7	16,5	126,7	50,0	20,0	25,0
SD105-18.00/18.99-95-20R7	02445815	18,0-18,99	95,0	177,7	108,7	17,5	127,7	50,0	20,0	25,0
SD105-19.00/19.99-95-20R7	02445816	19,0-19,99	95,0	178,5	109,5	18,5	128,5	50,0	20,0	25,0
SD105-20.00/21.99-125-25R7	02462843	20,0-21,99	125,0	214,5	138,5	19,5	158,5	56,0	25,0	31,0
SD105-22.00/23.99-125-25R7	02462848	22,0-23,99	125,0	214,5	138,5	21,5	158,5	56,0	25,0	31,0
SD105-24.00/25.99-125-25R7	02462850	24,0-25,99	125,0	214,5	138,5	23,5	158,5	56,0	25,0	31,0

Parti di ricambio, comprese nella fornitura

Per punta diametro (mm)	Chiave di bloccaggio	Vite di bloccaggio	Kit parti di ricambio
10,00-11,99	H1.5-2D	MP6SS3X12	SD105-SP-4.0
12,00-13,99	H1.5-2D	MP6SS3X12	SD105-SP-5.0
14,00-16,99	H2.0-2D	MP6SS4X12	SD105-SP-6.0
17,00-19,99	H2.5-2D	MP6SS5X16	SD105-SP-7.0
20,00-25,99	H2.5-2D	MP6SS5X16	SD105-SP-8.0

Accessori

Bit	Chiave dinamometrica
H00-1.5	H00-1509
H00-1.5	H00-1509
H00-2.0	H00-2020
H00-2.5	H00-2530
H00-2.5	H00-2535

Introduzione

Foratura

Alesatura

Barenatura

Allegato

SD105 – R7

Profondità di foratura ~ 5 x D – Codolo in pollici

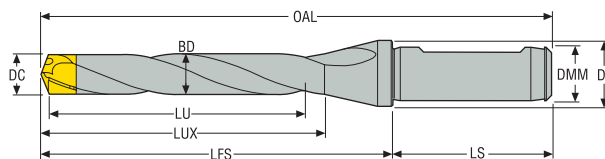

- Adduzione refrigerante interna
- ISO9766 per attacchi: Weldon 1835B, ISO 5414, DIN 60880
- Per i parametri di taglio raccomandati, vedere pagina(e) 195

Codice di ordinazione	Codice prodotto	DC	LU	BD	DF	OAL	LS	LFS	LUX	DMM
		Inch	Inch	Inch	Inch	Inch	Inch	Inch	Inch	Inch
SD105-10.00/10.49-50-0625R7	02466034	0.394-0.413	1.969	0.374	0.787	4.728	1.890	2.839	2.256	0.625
SD105-10.50/10.99-50-0625R7	02466037	0.413-0.433	1.969	0.394	0.787	4.748	1.890	2.858	2.256	0.625
SD105-11.00/11.49-50-0625R7	02466041	0.433-0.452	1.969	0.413	0.787	4.760	1.890	2.870	2.256	0.625
SD105-11.50/11.99-50-0625R7	02466042	0.453-0.472	1.969	0.433	0.787	4.776	1.890	2.886	2.295	0.625
SD105-12.00/12.49-65-0625R7	02445835	0.472-0.492	2.559	0.453	0.787	5.551	1.890	3.661	2.874	0.625
SD105-12.50/12.99-65-0625R7	02445836	0.492-0.511	2.559	0.472	0.787	5.567	1.890	3.677	2.890	0.625
SD105-13.00/13.99-65-0625R7	02445837	0.512-0.551	2.559	0.492	0.787	5.583	1.890	3.693	2.906	0.625
SD105-14.00/14.99-80-0625R7	02445838	0.551-0.590	3.150	0.531	0.787	6.197	1.890	4.307	3.520	0.625
SD105-15.00/15.99-80-0625R7	02445839	0.591-0.630	3.150	0.571	0.787	6.232	1.890	4.343	3.555	0.625
SD105-16.00/16.99-80-0625R7	02445840	0.630-0.669	3.150	0.610	0.787	6.260	1.890	4.370	3.583	0.625
SD105-17.00/17.99-95-0750R7	02445841	0.669-0.708	3.740	0.650	0.984	6.957	1.969	4.988	4.240	0.750
SD105-18.00/18.99-95-0750R7	02445842	0.709-0.748	3.740	0.689	0.984	6.996	1.969	5.028	4.280	0.750
SD105-19.00/19.99-95-0750R7	02445843	0.748-0.787	3.740	0.728	0.984	7.028	1.969	5.059	4.311	0.750
SD105-20.00/21.99-125-1000R7	02466052	0.787-0.866	4.921	0.768	1.220	8.445	2.205	6.240	5.453	1.000
SD105-22.00/23.99-125-1000R7	02466053	0.866-0.944	4.921	0.846	1.220	8.445	2.205	6.240	5.453	1.000
SD105-24.00/25.99-125-1000R7	02466054	0.945-1.023	4.921	0.925	1.220	8.445	2.205	6.240	5.453	1.000

Parti di ricambio, comprese nella fornitura

Per punta diametro (pollici)	Chiave di bloccaggio	Vite di bloccaggio	Kit parti di ricambio
0.394-0.472	H1.5-2D	MP6SS3X12	SD105-SP-4.0
0.472-0.551	H1.5-2D	MP6SS3X12	SD105-SP-5.0
0.551-0.669	H2.0-2D	MP6SS4X12	SD105-SP-6.0
0.669-0.787	H2.5-2D	MP6SS5X16	SD105-SP-7.0
0.787-1.023	H2.5-2D	MP6SS5X16	SD105-SP-8.0

Accessori

Bit	Chiave dinamometrica
H00-1.5	H00-1509
H00-1.5	H00-1509
H00-2.0	H00-2020
H00-2.5	H00-2530
H00-2.5	H00-2535

Introduzione

Foratura

Alesatura

Barenatura

Allegato

SD107 – R7

Profondità di foratura ~ 7 x D – Codolo metrico

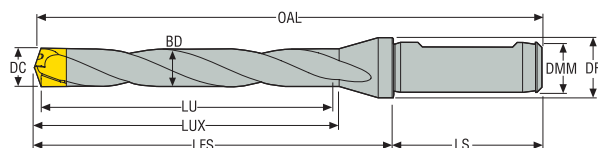

- Adduzione refrigerante interna
- ISO9766 per attacchi: Weldon 1835B, ISO 5414, DIN 60880
- Per i parametri di taglio raccomandati, vedere pagina(e) 196

Codice di ordinazione	Codice prodotto	DC	LU	OAL	LUX	BD	LFS	LS	DMM	DF
		mm	mm	mm	mm	mm	mm	mm	mm	mm
SD107-12.00/12.49-90-16R7	02427470	12,0-12,49	90,0	166,5	100,5	11,5	118,5	48,0	16,0	20,0
SD107-12.50/12.99-90-16R7	02427472	12,5-12,99	90,0	167,0	101,0	12,0	119,0	48,0	16,0	20,0
SD107-13.00/13.99-90-16R7	02427473	13,0-13,99	90,0	167,5	101,5	12,5	119,5	48,0	16,0	20,0
SD107-14.00/14.99-110-16R7	02427474	14,0-14,99	110,0	188,0	122,0	13,5	140,0	48,0	16,0	20,0
SD107-15.00/15.99-110-16R7	02427476	15,0-15,99	110,0	189,0	123,0	14,5	141,0	48,0	16,0	20,0
SD107-16.00/16.99-110-16R7	02427443	16,0-16,99	110,0	189,5	123,5	15,5	141,5	48,0	16,0	20,0
SD107-17.00/17.99-130-20R7	02427478	17,0-17,99	130,0	212,5	144,5	16,5	162,5	50,0	20,0	25,0
SD107-18.00/18.99-130-20R7	02427479	18,0-18,99	130,0	213,5	145,5	17,5	163,5	50,0	20,0	25,0
SD107-19.00/19.99-130-20R7	02427480	19,0-19,99	130,0	214,5	146,5	18,5	164,5	50,0	20,0	25,0
SD107-20.00/21.99-175-25R7	02530422	20,0-21,99	175,0	264,5	188,5	19,5	208,5	56,0	25,0	31,0
SD107-22.00/23.99-175-25R7	02530423	22,0-23,99	175,0	264,5	188,5	21,5	208,5	56,0	25,0	31,0
SD107-24.00/25.99-175-25R7	02517867	24,0-25,99	175,0	264,5	188,5	23,5	208,5	56,0	25,0	31,0

Parti di ricambio, comprese nella fornitura

Per punta diametro (mm)	Chiave di bloccaggio	Vite di bloccaggio	Kit parti di ricambio
12,00-13,99	H1.5-2D	MP6SS3X12	SD107-SP-5.0
14,00-16,99	H2.0-2D	MP6SS4X12	SD107-SP-6.0
17,00-19,99	H2.5-2D	MP6SS5X16	SD107-SP-7.0
20,00-25,99	H2.5-2D	MP6SS5X16	SD107-SP-8.0

Accessori

Bit	Chiave dinamometrica
H00-1.5	H00-1509
H00-2.0	H00-2020
H00-2.5	H00-2530
H00-2.5	H00-2535

Introduzione

Foratura

Alesatura

Barenatura

Allegato

SD107 – R7

Profondità di foratura ~ 7 x D – Codolo in pollici

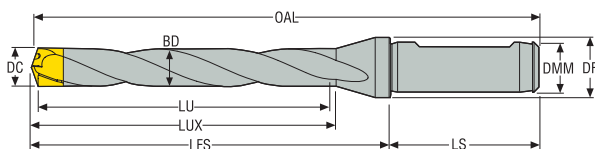

- Adduzione refrigerante interna
- ISO9766 per attacchi: Weldon 1835B, ISO 5414, DIN 60880
- Per i parametri di taglio raccomandati, vedere pagina(e) 196

Codice di ordinazione	Codice prodotto	DC	LU	BD	DF	OAL	LS	LFS	LUX	DMM
		Inch	Inch	Inch	Inch	Inch	Inch	Inch	Inch	Inch
SD107-12.00/12.49-90-0625R7	00040003	0.472-0.492	3.543	0.453	0.787	6.555	1.890	4.665	3.957	0.625
SD107-12.50/12.99-90-0625R7	00040004	0.492-0.511	3.543	0.472	0.787	6.575	1.890	4.685	3.976	0.625
SD107-13.00/13.99-90-0625R7	00040005	0.512-0.551	3.543	0.492	0.787	6.594	1.890	4.705	3.996	0.625
SD107-14.00/14.99-110-0625R7	00040006	0.551-0.590	4.331	0.531	0.787	7.402	1.890	5.512	4.803	0.625
SD107-15.00/15.99-110-0625R7	00040007	0.591-0.630	4.331	0.571	0.787	7.441	1.890	5.551	4.843	0.625
SD107-16.00/16.99-110-0625R7	00040008	0.630-0.669	4.331	0.610	0.787	7.461	1.890	5.571	4.862	0.625
SD107-17.00/17.99-130-0750R7	00040009	0.669-0.708	5.118	0.650	0.984	8.366	1.969	6.398	5.689	0.750
SD107-18.00/18.99-130-0750R7	00040010	0.709-0.748	5.118	0.689	0.984	8.406	1.969	6.437	5.728	0.750
SD107-19.00/19.99-130-0750R7	00040011	0.748-0.787	5.118	0.728	0.984	8.445	1.969	6.476	5.768	0.750
SD107-20.00/21.99-175-1000R7	02529095	0.787-0.866	6.890	0.768	1.220	10.413	2.205	8.209	7.421	1.000
SD107-22.00/23.99-175-1000R7	02530424	0.866-0.944	6.890	0.846	1.220	10.413	2.205	8.209	7.421	1.000
SD107-24.00/25.99-175-1000R7	02530425	0.945-1.023	6.890	0.925	1.220	10.413	2.205	8.209	7.421	1.000

Parti di ricambio, comprese nella fornitura

Per punta diametro (pollici)	Chiave di bloccaggio	Vite di bloccaggio	Kit parti di ricambio
0.472-0.551	H1.5-2D	MP6SS3X12	SD107-SP-5.0
0.551-0.669	H2.0-2D	MP6SS4X12	SD107-SP-6.0
0.669-0.787	H2.5-2D	MP6SS5X16	SD107-SP-7.0
0.787-1.023	H2.5-2D	MP6SS5X16	SD107-SP-8.0

Accessori

Per punta diametro (pollici)	Bit	Chiave dinamometrica
0.472-0.551	H00-1.5	H00-1509
0.551-0.669	H00-2.0	H00-2020
0.669-0.787	H00-2.5	H00-2530
0.787-1.023	H00-2.5	H00-2535

Introduzione

Foratura

Alesatura

Barenatura

Allegato

Corone – Geometria -P, -M e -K

Angolo di punta 140°

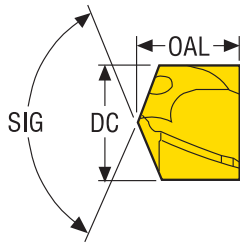

Codice di ordinazione	Codice prodotto	Geometria -P per acciaio	Geometria -M per acciaio inossidabile e leghe per alte temperature	Geometria -K per ghisa	DC		OAL	
					mm	inch	mm	inch
SD100-9.52-M	02700334	-	■	-	9,52	0.375	8,08	0.318
SD100-9.52-P	02673829	■	-	-	9,52	0.375	8,08	0.318
SD100-10.00-M	02469072	-	■	-	10,0	0.394	8,1	0.319
SD100-10.00-P	02469022	■	-	-	10,0	0.394	8,1	0.319
SD100-10.10-P	02469024	■	-	-	10,1	0.398	8,1	0.319
SD100-10.20-K	02544440	-	-	■	10,2	0.402	8,1	0.319
SD100-10.20-M	02469074	-	■	-	10,2	0.402	8,1	0.319
SD100-10.20-P	02469025	■	-	-	10,2	0.402	8,1	0.319
SD100-10.30-P	02469026	■	-	-	10,3	0.406	8,1	0.319
SD100-10.319-M	02469075	-	■	-	10,319	0.406	8,1	0.319
SD100-10.319-P	02469027	■	-	-	10,319	0.406	8,1	0.319
SD100-10.40-P	02592734	■	-	-	10,4	0.409	8,1	0.319
SD100-10.50-K	02556726	-	-	■	10,5	0.413	8,5	0.335
SD100-10.50-M	02469076	-	■	-	10,5	0.413	8,5	0.335
SD100-10.50-P	02469034	■	-	-	10,5	0.413	8,5	0.335
SD100-10.70-P	02469036	■	-	-	10,7	0.421	8,5	0.335
SD100-10.716-P	02469037	■	-	-	10,716	0.422	8,5	0.335
SD100-10.80-M	02469078	-	■	-	10,8	0.425	8,5	0.335
SD100-10.80-P	02469038	■	-	-	10,8	0.425	8,5	0.335
SD100-10.90-P	02469041	■	-	-	10,9	0.429	8,5	0.335
SD100-11.00-M	02469079	-	■	-	11,0	0.433	8,8	0.346
SD100-11.00-P	02469052	■	-	-	11,0	0.433	8,8	0.346
SD100-11.113-M	02469080	-	■	-	11,113	0.438	8,8	0.346
SD100-11.113-P	02469056	■	-	-	11,113	0.438	8,8	0.346
SD100-11.20-M	02469082	-	■	-	11,2	0.441	8,8	0.346
SD100-11.20-P	02469058	■	-	-	11,2	0.441	8,8	0.346
SD100-11.30-P	02469063	■	-	-	11,3	0.445	8,8	0.346
SD100-11.50-P	02469065	■	-	-	11,5	0.453	9,4	0.370
SD100-11.509-M	02469083	-	■	-	11,509	0.453	9,4	0.370
SD100-11.509-P	02469067	■	-	-	11,509	0.453	9,4	0.370
SD100-11.70-P	02469068	■	-	-	11,7	0.461	9,4	0.370
SD100-11.80-K	02542583	-	-	■	11,8	0.465	9,4	0.370
SD100-11.80-M	02469085	-	■	-	11,8	0.465	9,4	0.370
SD100-11.80-P	02469069	■	-	-	11,8	0.465	9,4	0.370
SD100-11.907-M	02592744	-	■	-	11,907	0.469	9,4	0.370
SD100-11.907-P	02469070	■	-	-	11,907	0.469	9,4	0.370
SD100-12.00-K	00090316	-	-	■	12,0	0.472	9,6	0.378
SD100-12.00-M	00090315	-	■	-	12,0	0.472	9,6	0.378

Introduzione

Foratura

Alesatura

Barenatura

Allegato

	Codice di ordinazione	Codice prodotto	Geometria -P per acciaio	Geometria -M per acciaio inossidabile e leghe per alte temperature	Geometria -K per ghisa	DC		OAL		
						mm	inch	mm	inch	
Introduzione	SD100-12.00-P	00090314	■	-	-	12,0	0.472	9,6	0.378	
	SD100-12.10-P	00039002	■	-	-	12,1	0.476	9,6	0.378	
	SD100-12.20-P	00048248	■	-	-	12,2	0.480	9,6	0.378	
	SD100-12.30-M	00071559	-	■	-	12,3	0.484	9,6	0.378	
	SD100-12.30-P	00071546	■	-	-	12,3	0.484	9,6	0.378	
	SD100-12.41-M	00059768	-	■	-	12,41	0.489	9,6	0.378	
	SD100-12.41-P	00059767	■	-	-	12,41	0.489	9,6	0.378	
Foratura	SD100-12.50-K	00090319	-	-	■	12,5	0.492	10,0	0.394	
	SD100-12.50-M	00090318	-	■	-	12,5	0.492	10,0	0.394	
	SD100-12.50-P	00090317	■	-	-	12,5	0.492	10,0	0.394	
	SD100-12.60-P	02207212	■	-	-	12,6	0.496	10,0	0.394	
	SD100-12.70-K	00059633	-	-	■	12,7	0.500	10,0	0.394	
	SD100-12.70-M	00059632	-	■	-	12,7	0.500	10,0	0.394	
	SD100-12.70-P	00059631	■	-	-	12,7	0.500	10,0	0.394	
	SD100-12.80-K	00059636	-	-	■	12,8	0.504	10,0	0.394	
	SD100-12.80-M	00059635	-	■	-	12,8	0.504	10,0	0.394	
	SD100-12.80-P	00059634	■	-	-	12,8	0.504	10,0	0.394	
	SD100-12.90-M	02503935	-	■	-	12,9	0.508	10,0	0.394	
	SD100-12.90-P	00030891	■	-	-	12,9	0.508	10,0	0.394	
	SD100-13.00-K	00098529	-	-	■	13,0	0.512	10,4	0.409	
	SD100-13.00-M	00098528	-	■	-	13,0	0.512	10,4	0.409	
	SD100-13.00-P	00098527	■	-	-	13,0	0.512	10,4	0.409	
	Alesatura	SD100-13.10-K	00059639	-	-	■	13,1	0.516	10,4	0.409
		SD100-13.10-M	00059638	-	■	-	13,1	0.516	10,4	0.409
SD100-13.10-P		00059637	■	-	-	13,1	0.516	10,4	0.409	
SD100-13.20-P		00030894	■	-	-	13,2	0.520	10,4	0.409	
SD100-13.30-M		00059641	-	■	-	13,3	0.524	10,4	0.409	
SD100-13.30-P		00059640	■	-	-	13,3	0.524	10,4	0.409	
SD100-13.50-K		00098532	-	-	■	13,5	0.531	10,4	0.409	
SD100-13.50-M		00098531	-	■	-	13,5	0.531	10,4	0.409	
SD100-13.50-P		00098530	■	-	-	13,5	0.531	10,4	0.409	
SD100-13.70-M		00059644	-	■	-	13,7	0.539	10,4	0.409	
Barenatura	SD100-13.70-P	00059643	■	-	-	13,7	0.539	10,4	0.409	
	SD100-13.80-K	00059648	-	-	■	13,8	0.543	10,4	0.409	
	SD100-13.80-M	00059647	-	■	-	13,8	0.543	10,4	0.409	
	SD100-13.80-P	00059646	■	-	-	13,8	0.543	10,4	0.409	
	SD100-13.89-M	00059771	-	■	-	13,89	0.547	10,4	0.409	
	SD100-13.89-P	00059770	■	-	-	13,89	0.547	10,4	0.409	
	SD100-14.00-K	00090322	-	-	■	14,0	0.551	11,0	0.433	
Allegato	SD100-14.00-M	00090321	-	■	-	14,0	0.551	11,0	0.433	
	SD100-14.00-P	00090320	■	-	-	14,0	0.551	11,0	0.433	
	SD100-14.10-P	00082712	■	-	-	14,1	0.555	11,0	0.433	
	SD100-14.20-K	00071549	-	-	■	14,2	0.559	11,0	0.433	
	SD100-14.20-M	00071561	-	■	-	14,2	0.559	11,0	0.433	
	SD100-14.20-P	00071548	■	-	-	14,2	0.559	11,0	0.433	
	SD100-14.29-K	00059675	-	-	■	14,29	0.563	11,0	0.433	
	SD100-14.29-M	00059674	-	■	-	14,29	0.563	11,0	0.433	
	SD100-14.29-P	00059673	■	-	-	14,29	0.563	11,0	0.433	
	SD100-14.40-P	02207869	■	-	-	14,4	0.567	11,0	0.433	
	SD100-14.50-K	00090325	-	-	■	14,5	0.571	11,0	0.433	
SD100-14.50-M	00090324	-	■	-	14,5	0.571	11,0	0.433		

Codice di ordinazione	Codice prodotto	Geometria -P per acciaio	Geometria -M per acciaio inossidabile e leghe per alte temperature	Geometria -K per ghisa	DC		OAL	
					mm	inch	mm	inch
SD100-14.50-P	00090323	■	-	-	14,5	0.571	11,0	0.433
SD100-14.68-K	00059775	-	-	■	14,68	0.578	11,0	0.433
SD100-14.68-M	00059774	-	■	-	14,68	0.578	11,0	0.433
SD100-14.68-P	00059773	■	-	-	14,68	0.578	11,0	0.433
SD100-14.70-M	00059650	-	■	-	14,7	0.579	11,0	0.433
SD100-14.70-P	00059649	■	-	-	14,7	0.579	11,0	0.433
SD100-14.80-M	00059653	-	■	-	14,8	0.583	11,0	0.433
SD100-14.80-P	00059652	■	-	-	14,8	0.583	11,0	0.433
SD100-14.90-M	02592745	-	■	-	14,9	0.587	11,0	0.433
SD100-14.90-P	00030895	■	-	-	14,9	0.587	11,0	0.433
SD100-15.00-K	00090328	-	-	■	15,0	0.591	11,9	0.469
SD100-15.00-M	00090327	-	■	-	15,0	0.591	11,9	0.469
SD100-15.00-P	00090326	■	-	-	15,0	0.591	11,9	0.469
SD100-15.08-M	00059777	-	■	-	15,08	0.594	11,9	0.469
SD100-15.08-P	00059776	■	-	-	15,08	0.594	11,9	0.469
SD100-15.10-P	00079342	■	-	-	15,1	0.594	11,9	0.469
SD100-15.20-P	00030896	■	-	-	15,2	0.598	11,9	0.469
SD100-15.25-K	00071551	-	-	■	15,25	0.600	11,9	0.469
SD100-15.25-M	00071562	-	■	-	15,25	0.600	11,9	0.469
SD100-15.25-P	00071550	■	-	-	15,25	0.600	11,9	0.469
SD100-15.48-K	00022926	-	-	■	15,48	0.609	11,9	0.469
SD100-15.48-M	00059780	-	■	-	15,48	0.609	11,9	0.469
SD100-15.48-P	00059779	■	-	-	15,48	0.609	11,9	0.469
SD100-15.50-K	00098535	-	-	■	15,5	0.610	11,9	0.469
SD100-15.50-M	00098534	-	■	-	15,5	0.610	11,9	0.469
SD100-15.50-P	00098533	■	-	-	15,5	0.610	11,9	0.469
SD100-15.70-M	00059656	-	■	-	15,7	0.618	11,9	0.469
SD100-15.70-P	00059655	■	-	-	15,7	0.618	11,9	0.469
SD100-15.80-K	00059660	-	-	■	15,8	0.622	11,9	0.469
SD100-15.80-M	00059659	-	■	-	15,8	0.622	11,9	0.469
SD100-15.80-P	00059658	■	-	-	15,8	0.622	11,9	0.469
SD100-15.88-K	00059678	-	-	■	15,88	0.625	11,9	0.469
SD100-15.88-M	00059677	-	■	-	15,88	0.625	11,9	0.469
SD100-15.88-P	00059676	■	-	-	15,88	0.625	11,9	0.469
SD100-16.00-K	00098538	-	-	■	16,0	0.630	12,6	0.496
SD100-16.00-M	00098537	-	■	-	16,0	0.630	12,6	0.496
SD100-16.00-P	00098536	■	-	-	16,0	0.630	12,6	0.496
SD100-16.10-P	00077964	■	-	-	16,1	0.634	12,6	0.496
SD100-16.20-P	00047365	■	-	-	16,2	0.638	12,6	0.496
SD100-16.25-P	00034081	■	-	-	16,25	0.640	12,6	0.496
SD100-16.27-K	00022929	-	-	■	16,27	0.641	12,6	0.496
SD100-16.27-M	00022928	-	■	-	16,27	0.641	12,6	0.496
SD100-16.27-P	00022927	■	-	-	16,27	0.641	12,6	0.496
SD100-16.40-P	02301114	■	-	-	16,4	0.646	12,6	0.496
SD100-16.50-K	00098541	-	-	■	16,5	0.650	12,6	0.496
SD100-16.50-M	00098540	-	■	-	16,5	0.650	12,6	0.496
SD100-16.50-P	00098539	■	-	-	16,5	0.650	12,6	0.496
SD100-16.67-K	00059681	-	-	■	16,67	0.656	12,6	0.496
SD100-16.67-M	00059680	-	■	-	16,67	0.656	12,6	0.496
SD100-16.67-P	00059679	■	-	-	16,67	0.656	12,6	0.496
SD100-16.70-K	00059663	-	-	■	16,7	0.657	12,6	0.496

Introduzione

Foratura

Alesatura

Barenatura

Allegato

	Codice di ordinazione	Codice prodotto	Geometria -P per acciaio	Geometria -M per acciaio inossidabile e leghe per alte temperature	Geometria -K per ghisa	DC		OAL		
						mm	inch	mm	inch	
Introduzione	SD100-16.70-M	00059662	-	■	-	16,7	0.657	12,6	0.496	
	SD100-16.70-P	00059661	■	-	-	16,7	0.657	12,6	0.496	
	SD100-16.80-K	00059666	-	-	■	16,8	0.661	12,6	0.496	
	SD100-16.80-M	00059665	-	■	-	16,8	0.661	12,6	0.496	
	SD100-16.80-P	00059664	■	-	-	16,8	0.661	12,6	0.496	
	SD100-16.90-M	02593463	-	■	-	16,9	0.665	12,6	0.496	
	SD100-16.90-P	00030898	■	-	-	16,9	0.665	12,6	0.496	
Foratura	SD100-17.00-K	00090331	-	-	■	17,0	0.669	13,3	0.524	
	SD100-17.00-M	00090330	-	■	-	17,0	0.669	13,3	0.524	
	SD100-17.00-P	00090329	■	-	-	17,0	0.669	13,3	0.524	
	SD100-17.07-K	00022933	-	-	■	17,07	0.672	13,3	0.524	
	SD100-17.07-M	00022932	-	■	-	17,07	0.672	13,3	0.524	
	SD100-17.07-P	00022931	■	-	-	17,07	0.672	13,3	0.524	
	SD100-17.10-P	00034083	■	-	-	17,1	0.673	13,3	0.524	
	SD100-17.20-K	02515762	-	-	■	17,2	0.677	13,3	0.524	
	SD100-17.20-P	00047714	■	-	-	17,2	0.677	13,3	0.524	
	SD100-17.30-K	02203711	-	-	■	17,3	0.681	13,3	0.524	
	SD100-17.46-M	00059683	-	■	-	17,46	0.687	13,3	0.524	
	SD100-17.46-P	00059682	■	-	-	17,46	0.687	13,3	0.524	
	SD100-17.50-K	00090334	-	-	■	17,5	0.689	13,3	0.524	
	SD100-17.50-M	00090333	-	■	-	17,5	0.689	13,3	0.524	
	SD100-17.50-P	00090332	■	-	-	17,5	0.689	13,3	0.524	
	Alesatura	SD100-17.70-K	00059669	-	-	■	17,7	0.697	13,3	0.524
		SD100-17.70-M	00059668	-	■	-	17,7	0.697	13,3	0.524
SD100-17.70-P		00059667	■	-	-	17,7	0.697	13,3	0.524	
SD100-17.80-K		00059672	-	-	■	17,8	0.701	13,3	0.524	
SD100-17.80-M		00059671	-	■	-	17,8	0.701	13,3	0.524	
SD100-17.80-P		00059670	■	-	-	17,8	0.701	13,3	0.524	
SD100-17.86-K		00022936	-	-	■	17,86	0.703	13,3	0.524	
SD100-17.86-M		00022935	-	■	-	17,86	0.703	13,3	0.524	
SD100-17.86-P		00022934	■	-	-	17,86	0.703	13,3	0.524	
SD100-17.90-M		02442098	-	■	-	17,9	0.705	13,3	0.524	
Barenatura	SD100-17.90-P	00047693	■	-	-	17,9	0.705	13,3	0.524	
	SD100-18.00-K	00090337	-	-	■	18,0	0.709	14,4	0.567	
	SD100-18.00-M	00090336	-	■	-	18,0	0.709	14,4	0.567	
	SD100-18.00-P	00090335	■	-	-	18,0	0.709	14,4	0.567	
	SD100-18.10-P	00030900	■	-	-	18,1	0.713	14,4	0.567	
	SD100-18.20-P	00038469	■	-	-	18,2	0.717	14,4	0.567	
	SD100-18.26-K	00035196	-	-	■	18,26	0.719	14,4	0.567	
	SD100-18.26-M	00022938	-	■	-	18,26	0.719	14,4	0.567	
	SD100-18.26-P	00022937	■	-	-	18,26	0.719	14,4	0.567	
	SD100-18.50-K	00059687	-	-	■	18,5	0.728	14,4	0.567	
Allegato	SD100-18.50-M	00059686	-	■	-	18,5	0.728	14,4	0.567	
	SD100-18.50-P	00059685	■	-	-	18,5	0.728	14,4	0.567	
	SD100-18.65-M	00035198	-	■	-	18,65	0.734	14,4	0.567	
	SD100-18.65-P	00035197	■	-	-	18,65	0.734	14,4	0.567	
	SD100-18.70-M	00059689	-	■	-	18,7	0.736	14,4	0.567	
	SD100-18.70-P	00059688	■	-	-	18,7	0.736	14,4	0.567	
	SD100-18.80-K	00059693	-	-	■	18,8	0.740	14,4	0.567	
	SD100-18.80-M	00059692	-	■	-	18,8	0.740	14,4	0.567	
SD100-18.80-P	00059691	■	-	-	18,0	0.709	14,4	0.567		

Codice di ordinazione	Codice prodotto	Geometria -P per acciaio	Geometria -M per acciaio inossidabile e leghe per alte temperature	Geometria -K per ghisa	DC		OAL	
					mm	inch	mm	inch
SD100-18.90-M	02592746	-	■	-	18,9	0.744	14,4	0.567
SD100-18.90-P	00030901	■	-	-	18,9	0.744	14,4	0.567
SD100-19.00-K	00059696	-	-	■	19,0	0.748	15,2	0.598
SD100-19.00-M	00059695	-	■	-	19,0	0.748	15,2	0.598
SD100-19.00-P	00059694	■	-	-	19,0	0.748	15,2	0.598
SD100-19.05-K	00059699	-	-	■	19,05	0.750	15,2	0.598
SD100-19.05-M	00059698	-	■	-	19,05	0.750	15,2	0.598
SD100-19.05-P	00059697	■	-	-	19,05	0.750	15,2	0.598
SD100-19.10-P	00030902	■	-	-	19,1	0.752	15,2	0.598
SD100-19.20-K	00071566	-	-	■	19,2	0.756	15,2	0.598
SD100-19.20-M	00071564	-	■	-	19,2	0.756	15,2	0.598
SD100-19.20-P	00071563	■	-	-	19,2	0.756	15,2	0.598
SD100-19.25-P	00048318	■	-	-	19,25	0.758	15,2	0.598
SD100-19.45-K	00035202	-	-	■	19,45	0.766	15,2	0.598
SD100-19.45-M	00035201	-	■	-	19,45	0.766	15,2	0.598
SD100-19.45-P	00035200	■	-	-	19,45	0.766	15,2	0.598
SD100-19.50-K	00059702	-	-	■	19,5	0.768	15,2	0.598
SD100-19.50-M	00059701	-	■	-	19,5	0.768	15,2	0.598
SD100-19.50-P	00059700	■	-	-	19,5	0.768	15,2	0.598
SD100-19.70-K	00059705	-	-	■	19,7	0.776	15,2	0.598
SD100-19.70-M	00059704	-	■	-	19,7	0.776	15,2	0.598
SD100-19.70-P	00059703	■	-	-	19,7	0.776	15,2	0.598
SD100-19.80-K	00059708	-	-	■	19,8	0.780	15,2	0.598
SD100-19.80-M	00059707	-	■	-	19,8	0.780	15,2	0.598
SD100-19.80-P	00059706	■	-	-	19,8	0.780	15,2	0.598
SD100-19.84-M	00035204	-	■	-	19,84	0.781	15,2	0.598
SD100-19.84-P	00035203	■	-	-	19,84	0.781	15,2	0.598
SD100-19.90-M	02592747	-	■	-	19,9	0.783	15,2	0.598
SD100-19.90-P	00010065	■	-	-	19,9	0.783	15,2	0.598
SD100-19.99-P	00081744	■	-	-	19,99	0.787	15,2	0.598
SD100-20.00-K	02433368	-	-	■	20,0	0.787	15,2	0.598
SD100-20.00-M	02469176	-	■	-	20,0	0.787	15,2	0.598
SD100-20.00-P	02469095	■	-	-	20,0	0.787	15,2	0.598
SD100-20.241-P	02469096	■	-	-	20,241	0.797	15,2	0.598
SD100-20.50-K	02569177	-	-	■	20,5	0.807	15,2	0.598
SD100-20.50-M	02469178	-	■	-	20,5	0.807	15,2	0.598
SD100-20.50-P	02469098	■	-	-	20,5	0.807	15,2	0.598
SD100-20.638-M	02469179	-	■	-	20,638	0.813	15,2	0.598
SD100-20.638-P	02469100	■	-	-	20,638	0.813	15,2	0.598
SD100-20.80-P	02508750	■	-	-	20,8	0.819	15,2	0.598
SD100-20.90-P	02586615	■	-	-	20,9	0.823	15,2	0.598
SD100-21.00-K	02523183	-	-	■	21,0	0.827	15,2	0.598
SD100-21.00-M	02469180	-	■	-	21,0	0.827	15,2	0.598
SD100-21.00-P	02469118	■	-	-	21,0	0.827	15,2	0.598
SD100-21.034-P	02469120	■	-	-	21,034	0.828	15,2	0.598
SD100-21.20-P	02469121	■	-	-	21,2	0.835	15,2	0.598
SD100-21.30-P	02521624	■	-	-	21,3	0.839	15,2	0.598
SD100-21.430-M	02469182	-	■	-	21,43	0.844	15,2	0.598
SD100-21.430-P	02469122	■	-	-	21,43	0.844	15,2	0.598
SD100-21.50-K	02521338	-	-	■	21,5	0.846	15,2	0.598
SD100-21.50-M	02469183	-	■	-	21,5	0.846	15,2	0.598

Introduzione

Foratura

Alesatura

Barenatura

Allegato

	Codice di ordinazione	Codice prodotto	Geometria -P per acciaio	Geometria -M per acciaio inossidabile e leghe per alte temperature	Geometria -K per ghisa	DC		OAL	
						mm	inch	mm	inch
Introduzione	SD100-21.50-P	02469124	■	-	-	21,5	0.846	15,2	0.598
	SD100-21.80-K	02592763	-	-	■	21,8	0.858	15,2	0.598
	SD100-21.80-M	02555978	-	■	-	21,8	0.858	15,2	0.598
	SD100-21.80-P	02592735	■	-	-	21,8	0.858	15,2	0.598
	SD100-21.829-P	02469125	■	-	-	21,829	0.859	15,2	0.598
	SD100-21.90-M	02592752	-	■	-	21,9	0.862	15,2	0.598
	SD100-21.90-P	02592736	■	-	-	21,9	0.862	15,2	0.598
Foratura	SD100-22.00-K	02511599	-	-	■	22,0	0.866	15,2	0.598
	SD100-22.00-M	02469185	-	■	-	22,0	0.866	15,2	0.598
	SD100-22.00-P	02469128	■	-	-	22,0	0.866	15,2	0.598
	SD100-22.225-M	02469186	-	■	-	22,225	0.875	15,2	0.598
	SD100-22.225-P	02469129	■	-	-	22,225	0.875	15,2	0.598
	SD100-22.50-K	02569178	-	-	■	22,5	0.886	15,2	0.598
	SD100-22.50-M	02469188	-	■	-	22,5	0.886	15,2	0.598
	SD100-22.50-P	02469132	■	-	-	22,5	0.886	15,2	0.598
	SD100-22.621-P	02469133	■	-	-	22,621	0.891	15,2	0.598
	SD100-22.80-M	02592754	-	■	-	22,8	0.898	15,2	0.598
	SD100-22.80-P	02539323	■	-	-	22,8	0.898	15,2	0.598
	SD100-22.90-P	02592738	■	-	-	22,9	0.902	15,2	0.598
	SD100-23.00-K	02515181	-	-	■	23,0	0.906	15,2	0.598
	SD100-23.00-M	02469189	-	■	-	23,0	0.906	15,2	0.598
SD100-23.00-P	02469134	■	-	-	23,0	0.906	15,2	0.598	
Alesatura	SD100-23.416-P	02469136	■	-	-	23,416	0.922	15,2	0.598
	SD100-23.50-K	02551252	-	-	■	23,5	0.925	15,2	0.598
	SD100-23.50-M	02469190	-	■	-	23,5	0.925	15,2	0.598
	SD100-23.50-P	02469138	■	-	-	23,5	0.925	15,2	0.598
	SD100-23.813-K	02592766	-	-	■	23,813	0.938	15,2	0.598
	SD100-23.813-M	02554971	-	■	-	23,813	0.938	15,2	0.598
	SD100-23.813-P	02469140	■	-	-	23,813	0.938	15,2	0.598
	SD100-23.90-M	02592756	-	■	-	23,9	0.941	15,2	0.598
	SD100-23.90-P	02592739	■	-	-	23,9	0.941	15,2	0.598
	SD100-24.00-K	02569179	-	-	■	24,0	0.945	15,2	0.598
Barenatura	SD100-24.00-M	02469191	-	■	-	24,0	0.945	15,2	0.598
	SD100-24.00-P	02469141	■	-	-	24,0	0.945	15,2	0.598
	SD100-24.209-P	02469142	■	-	-	24,209	0.953	15,2	0.598
	SD100-24.50-K	02569180	-	-	■	24,5	0.965	15,2	0.598
	SD100-24.50-M	02469192	-	■	-	24,5	0.965	15,2	0.598
	SD100-24.50-P	02469144	■	-	-	24,5	0.965	15,2	0.598
	SD100-24.605-P	02469145	■	-	-	24,605	0.969	15,2	0.598
	SD100-24.80-K	02592767	-	-	■	24,8	0.976	15,2	0.598
	SD100-24.80-M	02508165	-	■	-	24,8	0.976	15,2	0.598
	SD100-24.80-P	02529665	■	-	-	24,8	0.976	15,2	0.598
Allegato	SD100-24.90-M	02592757	-	■	-	24,9	0.980	15,2	0.598
	SD100-24.90-P	02592740	■	-	-	24,9	0.980	15,2	0.598
	SD100-25.00-K	02524629	-	-	■	25,0	0.984	15,2	0.598
	SD100-25.00-M	02469193	-	■	-	25,0	0.984	15,2	0.598
	SD100-25.00-P	02469146	■	-	-	25,0	0.984	15,2	0.598
	SD100-25.40-K	02569181	-	-	■	25,4	1.000	15,2	0.598
	SD100-25.400-M	02469194	-	■	-	25,4	1.000	15,2	0.598
	SD100-25.400-P	02469147	■	-	-	25,4	1.000	15,2	0.598
	SD100-25.50-P	02536609	■	-	-	25,5	1.004	15,2	0.598

Codice di ordinazione	Codice prodotto	Geometria -P per acciaio	Geometria -M per acciaio inossidabile e leghe per alte temperature	Geometria -K per ghisa	DC		OAL	
					mm	inch	mm	inch
SD100-25.60-P	02519477	■	-	-	25,6	1.008	15,2	0.598
SD100-25.80-M	02592758	-	■	-	25,8	1.016	15,2	0.598
SD100-25.80-P	02581593	■	-	-	25,8	1.016	15,2	0.598
SD100-25.90-M	02592759	-	■	-	25,9	1.020	15,2	0.598
SD100-25.90-P	02592741	■	-	-	25,9	1.020	15,2	0.598
SD100-25.99-K	02516403	-	-	■	25,99	1.023	15,2	0.598
SD100-25.99-P	02516402	■	-	-	25,99	1.023	15,2	0.598

■ Prodotto standard.

Introduzione

Foratura

Alesatura

Barenatura

Allegato

Modulo per smussi

Introduzione

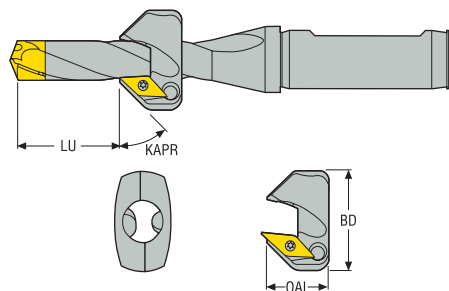

Foratura

Codice di ordinazione	Codice prodotto	Per corpo punta	LU profondità di foratura								Max profondità smusso (mm)		
			SD101 (min-max)		SD103 (min-max)		SD105 (min-max)		SD107 (min-max)		OAL	BD	
			mm Inch	mm Inch	mm Inch	mm Inch	mm Inch	mm Inch	mm Inch	mm Inch			
SD100-C45-12.00/12.49	00014922	SD10x-12.00/12.49	12,0 0.472	13,0 0.512	12,0 0.472	28,0 1.102	28,0 1.102	53,0 2.087	53,0 2.087	78,0 3.071	1,5 0.059	19,0 0.748	28,0 1.102
SD100-C45-12.50/12.99	00014923	SD10x-12.50/12.99	12,0 0.472	14,0 0.551	12,0 0.472	29,0 1.142	29,0 1.142	54,0 2.126	54,0 2.126	79,0 3.110	1,5 0.059	19,0 0.748	28,0 1.102
SD100-C45-13.00/13.99	00014924	SD10x-13.00/13.99	13,0 0.512	14,0 0.551	13,0 0.512	29,0 1.142	29,0 1.142	54,0 2.126	54,0 2.126	79,0 3.110	1,5 0.059	19,0 0.748	28,0 1.102
SD100-C45-14.00/14.99	00014928	SD10x-14.00/14.99	14,0 0.551	20,0 0.787	14,0 0.551	40,0 1.575	40,0 1.575	70,0 2.756	70,0 2.756	100,0 3.937	2,0 0.079	19,0 0.748	31,0 1.220
SD100-C45-15.00/15.99	00014931	SD10x-15.00/15.99	14,0 0.551	21,0 0.827	14,0 0.551	41,0 1.614	41,0 1.614	71,0 2.795	71,0 2.795	101,0 3.976	2,0 0.079	19,0 0.748	31,0 1.220
SD100-C45-16.00/16.99	00014932	SD10x-16.00/16.99	15,0 0.591	22,0 0.866	15,0 0.591	42,0 1.654	42,0 1.654	72,0 2.835	72,0 2.835	102,0 4.016	2,0 0.079	19,0 0.748	31,0 1.220
SD100-C45-17.00/17.99	00014933	SD10x-17.00/17.99	16,0 0.630	25,0 0.984	16,0 0.630	51,0 2.008	51,0 2.008	87,0 3.425	87,0 3.425	123,0 4.843	2,0 0.079	19,0 0.748	36,0 1.417
SD100-C45-18.00/18.99	00014935	SD10x-18.00/18.99	17,0 0.669	26,0 1.024	17,0 0.669	52,0 2.047	52,0 2.047	88,0 3.465	88,0 3.465	124,0 4.882	2,0 0.079	19,0 0.748	36,0 1.417
SD100-C45-19.00/19.99	00014936	SD10x-19.00/19.99	18,0 0.709	27,0 1.063	18,0 0.709	53,0 2.087	53,0 2.087	89,0 3.504	89,0 3.504	125,0 4.921	2,0 0.079	19,0 0.748	36,0 1.417

Alesatura

Parti di ricambio, comprese nella fornitura

Per punta diametro (mm)	Vite di bloccaggio inserto		Chiave per vite inserto		Chiave di bloccaggio	
	Inserto	Modulo	Inserto	Modulo		
SD100-12.00-16.99	C02205-T07P	C04011-T15P	T07P-2	T15P-2		
SD100-17.00-19.99	C02205-T07P	C05012-T15P	T07P-2	T15P-2		

Barenatura

Inserto

Tolleranze: mm/inch	Dimensione	L	RE	IC	D1	S
		mm/inch	mm/inch	mm/inch	mm/inch	mm/inch
	09	9,0/ 2187	35°	0,2/ 0078	5,556/ 2187	2,9/ 1141
		Qualità: T400D				
		Descrizione: VCGX090202-D1				
		Codice prodotto: 00014948				

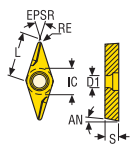

IC = ±0,025/ 0009842
S = ±0,07/ 0027559
RE = ±0,10/ 0039370

Allegato

Modulo per smussi – Istruzioni di montaggio/posizionamento del modulo

- 1.** Smontare la corona dalla punta, quindi inserire il modulo senza inserti sul corpo punta.

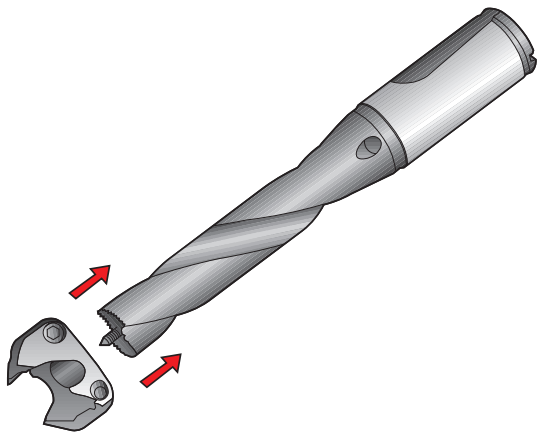

- 2.1** Posizionare il modulo il più vicino possibile all'attacco punta.

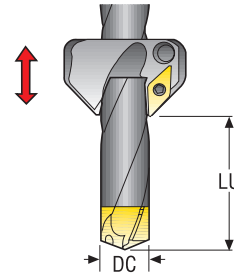

DC		LU profondità di foratura (min-max)			
mm	pollici	SD101		SD103	
mm	pollici	mm	pollici	mm	pollici
12	.472	12-13	.472-.512	12-28	.472-1.102
12,5	.492	12-14	.472-.551	12-29	.472-1.142
13	.512	13-14	.512-.551	13-29	.512-1.142
14	.551	14-20	.551-.787	14-40	.551-1.575
15	.591	14-21	.551-.827	14-41	.551-1.614
16	.630	15-22	.591-.866	15-42	.591-1.654
17	.669	16-25	.630-.984	16-51	.630-2.008
18	.709	17-26	.669-1.024	17-52	.669-2.047
19	.748	18-27	.709-1.063	18-53	.709-2.087

- 2.2** Posizionare il modulo il più vicino possibile all'attacco punta.

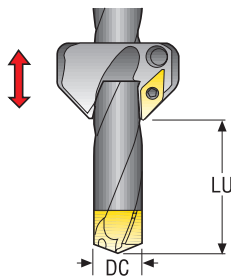

DC		LU profondità di foratura (min-max)			
mm	pollici	SD105		SD107	
mm	pollici	mm	pollici	mm	pollici
12	.472	28-53	1.102-2.087	53-78	2.087-3.071
12,5	.492	29-54	1.142-2.126	54-79	2.126-3.110
13	.512	29-54	1.142-2.126	54-79	2.126-3.110
14	.551	40-70	1.575-2.756	70-100	2.756-3.937
15	.591	41-71	1.614-2.785	71-101	2.795-3.976
16	.630	42-72	1.654-2.835	72-102	2.835-4.016
17	.669	51-87	2.008-3.425	87-123	3.425-4.843
18	.709	52-88	2.047-3.465	88-124	3.465-4.882
19	.748	53-89	2.087-3.504	89-125	3.504-4.921

- 3.** Serrare entrambe le viti con i valori di coppia indicati nella tabella riportata sotto.

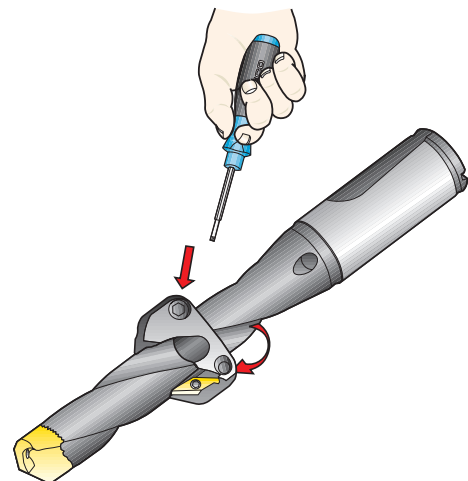

DC		M	
mm	pollici	Nm	in-lbs
12-19	.472-.748	3-4	26-35

Modulo per smussi

Le velocità di taglio e gli avanzamenti consigliati per le punte Crownloc® alle pagine 193-196 dovrebbero essere utilizzati anche durante le operazioni di smussatura.

Problemi e soluzioni

Vibrazioni durante l'esecuzione dello smusso

- Ridurre la velocità di taglio
- Se possibile, spostare il modulo più vicino all'attacco della punta
- Se possibile, utilizzare una punta più corta

Massima profondità di smussatura

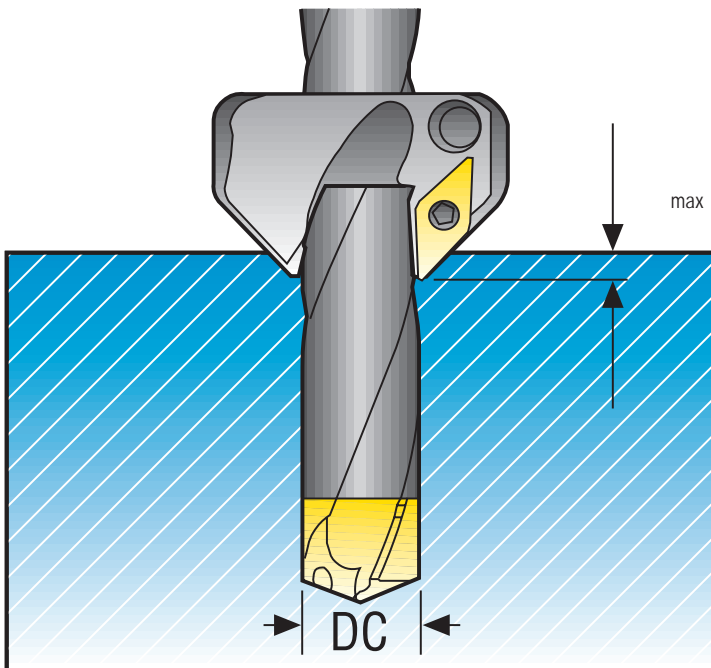

DC		Max	
mm	pollici	mm	pollici
12-13	.472-512	1,5	.059
14-19	.551-.748	2	.079

Parametri di lavorazione

I valori dei grafici variano in funzione dei parametri di taglio, dei materiali, dell'efficienza della macchina e dell'usura dell'utensile. I grafici sono validi per foratura del gruppo materiale Seco (SMG) P5-P6 e per una velocità di taglio di 90 m/min (295 sf/min).

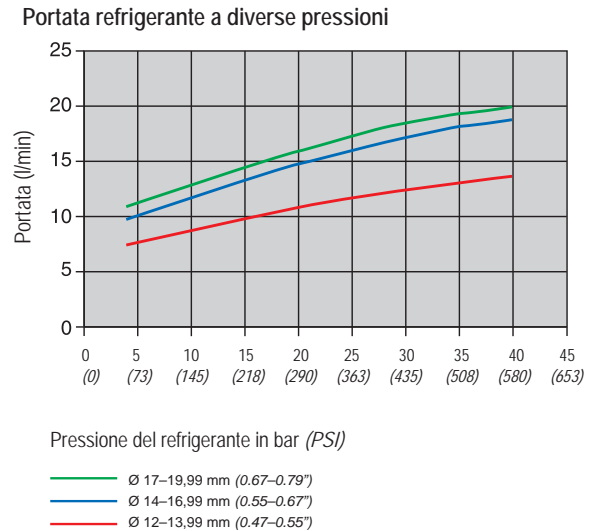
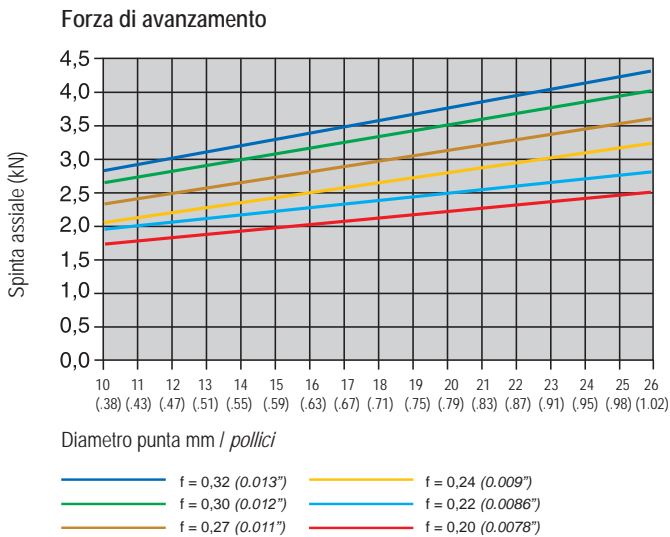
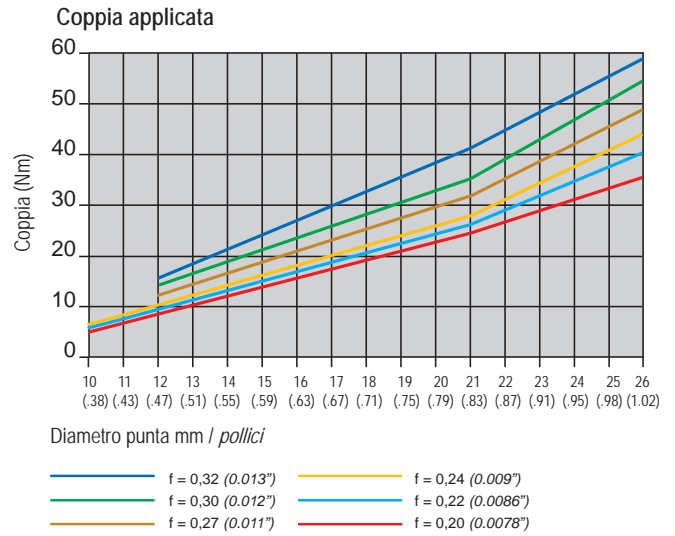
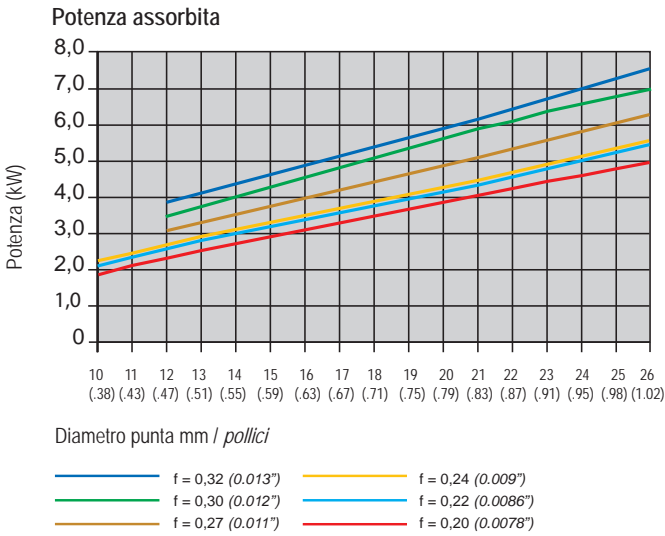

Portata refrigerante raccomandata $Dx1 \text{ l/min}$
 Portata refrigerante minima $D/2 \text{ l/min}$
 D = Diametro punta
 Pressione minima refrigerante raccomandata 10 bar (145 PSI) con $< 3 \times D$
 Pressione minima refrigerante raccomandata 20 bar (290 PSI) con $> 3 \times D$
 Pressione minima refrigerante raccomandata 40 bar (580 PSI) con $> 5 \times D$

Composizione del refrigerante
 Percentuale di olio nell'emulsione raccomandata: 6-8%.
 Per forare acciaio inossidabile, superleghe ed acciai ad alta resistenza, si consiglia di utilizzare una concentrazione del 10%.

Consigli di lavorazione
 È possibile eseguire forature a pacco solo se i pezzi sono saldamente serrati l'uno contro l'altro, così da non avere interstizi tra le parti. Gli interstizi possono influenzare l'evacuazione dei trucioli e quindi danneggiare la punta.

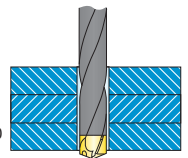

Tolleranza del foro/Finitura superficiale

SD101, SD103, SD105 e SD107 IT9-10 / $R_a 1-4^*$, $R_a 39-157 \mu\text{in}^*$					
\varnothing punta DC (mm)	Tolleranza IT9 (μm)	Tolleranza IT10 (μm)	\varnothing Punta DC (pollici)	Tolleranza IT9 (pollici)	Tolleranza IT10 (pollici)
0 - +10-18	0 - +43	0 - +70	0 - +0.394-0.709	0 - +0.0017	0 - +0.0028
0 - +18-30	0 - +52	0 - +84	0 - +0.709-1.181	0 - +0.0020	0 - +0.0033

*Quando si forano acciai inossidabili e acciai a basso tenore di carbonio, si può verificare un deterioramento della finitura superficiale e della tolleranza del foro. Per la migliore qualità del foro, impiegare la punta più corta possibile.

Problemi e soluzioni – Verifiche iniziali:

- Stabilità del fissaggio
- Condizioni del mandrino macchina
- Condizioni del portautensile

- Bloccaggio dell'utensile:
 - Eccentricità entro 0,06 TIR

- Evacuazione del truciolo:
 - Parametri di taglio

- Refrigerante:
 - Pressione
 - Flusso
 - Concentrazione

<p>Scheggiature del tagliente</p> <ul style="list-style-type: none"> • Ridurre l'avanzamento/giro • In presenza di vibrazioni, ridurre la velocità di taglio ed aumentare l'avanzamento • Quando si forano superfici grezze, dure o inclinate, ridurre l'avanzamento del 30-50% in fase di entrata e di uscita 		<p>Tolleranza diametro non soddisfacente</p> <ul style="list-style-type: none"> • Aumentare l'avanzamento/giro • Utilizzare una punta in metallo duro integrale Seco Feedmax, vedere le pagine 15-17 • Effettuare un'operazione di alesatura, vedere le pagine 327 • Effettuare un'operazione di barenatura, vedere le pagine 516-517 	
<p>Rapida usura del tagliente</p> <ul style="list-style-type: none"> • Verificare che si utilizzi la giusta geometria • Ridurre la velocità di taglio 		<p>Cattiva finitura superficiale</p> <ul style="list-style-type: none"> • Ridurre l'avanzamento/giro • Aumentare la velocità di taglio • Verificare che si utilizzi la giusta geometria • Utilizzare una punta in metallo duro integrale Seco Feedmax, vedere le pagine 15-17 • Effettuare un'operazione di alesatura, vedere pagina 327 	
<p>Usura ad intaglio</p> <ul style="list-style-type: none"> • Ridurre l'avanzamento al giro • Ridurre la velocità di taglio • Aumentare la percentuale di olio nel refrigerante 		<p>Posizione foro non soddisfacente</p> <ul style="list-style-type: none"> • Ridurre l'avanzamento/giro • Quando si forano superfici grezze, dure o inclinate, ridurre l'avanzamento del 30-50% in fase di entrata e uscita • Preforare con un angolo punta a 140° • Utilizzare una punta in metallo duro integrale Seco Feedmax, vedere le pagine 15-17 • Effettuare un'operazione di barenatura, vedere le pagine 516-517 	
<p>Usura dei bordini esterni</p> <ul style="list-style-type: none"> • Verificare che si utilizzi la giusta geometria • Ridurre la velocità di taglio • Aumentare la concentrazione del refrigerante • Quando si forano superfici grezze, dure o inclinate, ridurre l'avanzamento del 30-50% in fase di entrata e di uscita 		<p>Trucioli lunghi che causano problemi di evacuazione</p> <ul style="list-style-type: none"> • Aumentare l'avanzamento • Per materiali che producono trucioli lunghi e gruppi materiale P1-P4, M1-M2: <ul style="list-style-type: none"> - Aumentare la velocità di taglio e diminuire l'avanzamento/giro - Utilizzare la geometria L (Custom Design) 	
<p>Rottura all'uscita del foro</p> <ul style="list-style-type: none"> • Se il sistema di ritenzione si rompe quando la corona sta per fuoriuscire da un foro passante, La rottura è dovuta a: <ul style="list-style-type: none"> - L'interfaccia non è stata accuratamente pulita e ci sono ancora dei trucioli o impurità tra la corona ed il corpo punta. - La corona non è stata bloccata saldamente. Usare la chiave dinamometrica - I pochi filetti in presa non sono in grado di garantire la corretta ritenzione. 		<p>Scheggiatura della superficie di contatto</p> <ul style="list-style-type: none"> • Piccole scheggiature non compromettono il sistema di bloccaggio e non producono conseguenze sulla qualità della foratura • Se si verificano scheggiature di rilievo quando si utilizzano elevati avanzamenti o quando si forano superfici inclinate, ridurre l'avanzamento 	





Crownloc® Plus

Seco Crownloc® Plus è una nuova generazione di punte Seco con corone intercambiabili. Dotata di una nuova connessione, Crownloc Plus migliora l'evacuazione del truciolo e la resistenza all'usura su un'ampia gamma di materiali.

- Inoltre, è caratterizzata da design robusto del corpo punta, connessione ad alta resistenza, eliche profonde ed ampie e corpo lucidato.
- Prima scelta per applicazioni generiche, la geometria P è una soluzione robusta e versatile.
- La geometria M offre prestazioni eccellenti in leghe per alte temperature leghe di titanio e acciaio inossidabile

Panoramica della gamma

Crownloc® Plus	Gamma Ø	Profondità di foratura	Tolleranza Ø punta	Tolleranza foro (1)	Finitura superficiale (2)
SD403  Pagine 203-206	12,00-19,99 mm (0.472-0.787")	~ 3 x D	k7	IT 9-10	Ra 1-3 µm (Ra 39-118 µin)
SD405  Pagine 207-210	12,00-19,99 mm (0.472-0.787")	~ 5 x D	k7	IT 10	Ra 1-3 µm (Ra 39-118 µin)
SD408  Pagine 211-214	12,00-19,99 mm (0.472-0.787")	~ 8 x D	k7	IT 10	Ra 1-3 µm (Ra 39-118 µin)

1) Possono verificarsi variazioni a seconda del materiale da lavorare e dei parametri di taglio utilizzati.

2) La profondità di foratura, i parametri di taglio, la pressione del refrigerante e il materiale da lavorare possono causare il deterioramento della finitura superficiale.

Chiavi di codifica

Corpi punta Crownloc® Plus

Misure metriche

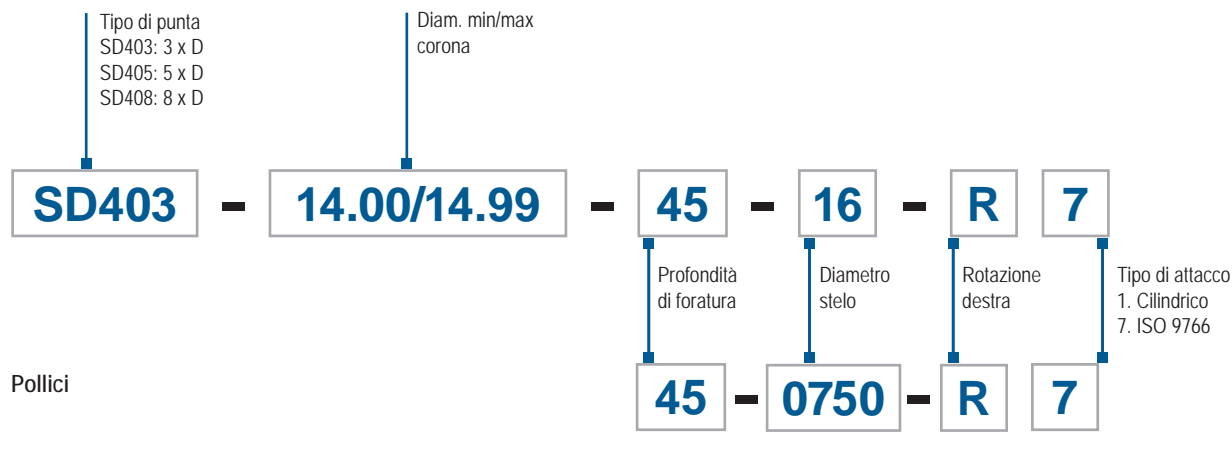

Corone chiavi di codifica

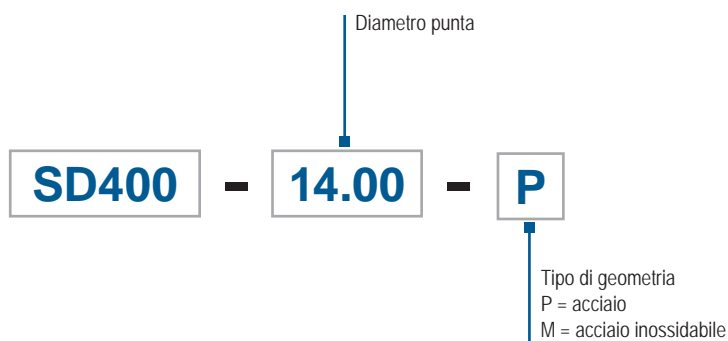

Geometrie

Geometria -P
- Geometria universale, prima scelta per foratura di acciaio



Geometria -M
- Per acciaio inossidabile e leghe per alte temperature



Istruzioni di montaggio

Introduzione

1. Stabilità

La stabilità dell'applicazione è fondamentale per avere lunghe durate e finiture ottimali dei fori eseguiti. Controllare le condizioni del mandrino macchina, il fissaggio e lo staffaggio dei componenti per assicurare la massima rigidità e stabilità. Condizioni di lavoro poco stabili possono causare la rottura dell'utensile.

2. Utensile rotante

Nelle applicazioni rotanti, il TIR (Total Indicated Run-out) non dovrebbe eccedere 0,06 mm (0,002"). Misurare l'eccentricità quando la punta è montata sul mandrino, ruotando la punta di 360°.

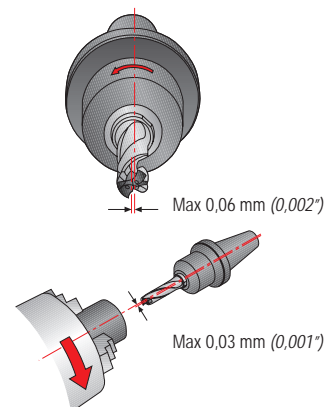

3. Utensile non rotante

Nelle applicazioni non rotanti, la distanza tra l'asse della punta e ed il centro di rotazione del pezzo non dovrebbe eccedere 0,03 mm (0,001") radialmente.

Foratura

4. Portautensili consigliati

Seco Tools offre un'ampia gamma di portautensili (porta pinze, a calettamento termico, mandrini idraulici Weldon...), disponibili per una varietà di tipi di mandrini per macchine. Per i migliori risultati, utilizzare attacchi tipo ERHP 5672, pinze ad alta precisione. Per ulteriori informazioni, vedere il catalogo Sistemi di Utensili.



Pinza ad alta precisione
(solo per attacchi cilindrici -R1)



Attacchi a bloccaggio idraulico
(solo per attacchi cilindrici -R1)



Weldon

Alesatura

1.

Per smontare la corona, individuare i due piani per l'inserimento della chiave.



2.

Per rimuovere la corona, ruotare la chiave in senso antiorario di un quarto di giro.



3.

Pulire l'interfaccia prima di montare la corona.



Barenatura

4.

Per un bloccaggio più semplice, pre-serrare la corona con le dita prima di usare la chiave.



5.

Simultaneamente, tenere premuta la corona mentre si ruota la chiave di un quarto di giro in senso orario, tenendola perpendicolare al corpo punta.



6.

Quando la corona è montata sul corpo punta, ci deve essere contatto completo tra le superfici di accoppiamento sul corpo sulla corona (vedere la fotografia).



Allegato

SD403 – R7

Profondità di foratura ~ 3 x D – Codolo metrico

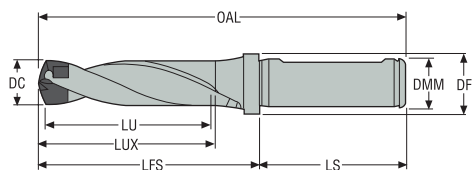

- Adduzione refrigerante interna
- ISO9766 per attacchi: Weldon 1835B, ISO 5414, DIN 60880
- Per i parametri di taglio raccomandati, vedere pagina(e) 219

Codice di ordinazione	Codice prodotto	DC	LU	OAL	LUX	LFS	LS	DMM	DF
		mm	mm	mm	mm	mm	mm	mm	mm
SD403-12.00/12.49-38-16R7	02622894	12,0-12,49	38,0	106,2	46,2	58,2	48,0	16,0	20,0
SD403-12.50/12.99-39-16R7	02622895	12,5-12,99	39,0	108,0	47,5	60,0	48,0	16,0	20,0
SD403-13.00/13.99-42-16R7	02622896	13,0-13,99	42,0	111,9	50,9	63,9	48,0	16,0	20,0
SD403-14.00/14.99-45-16R7	02622898	14,0-14,99	45,0	116,5	54,5	68,5	48,0	16,0	20,0
SD403-15.00/15.99-48-16R7	02622899	15,0-15,99	48,0	121,2	58,2	73,2	48,0	16,0	20,0
SD403-16.00/16.99-51-20R7	02622900	16,0-16,99	51,0	127,9	61,9	77,9	50,0	20,0	24,0
SD403-17.00/17.99-54-20R7	02622902	17,0-17,99	54,0	132,6	65,6	82,6	50,0	20,0	24,0
SD403-18.00/18.99-57-20R7	02622903	18,0-18,99	57,0	137,3	69,3	87,3	50,0	20,0	24,0
SD403-19.00/19.99-60-20R7	02622905	19,0-19,99	60,0	142,0	73,0	92,0	50,0	20,0	24,0

Accessori

Per punta diametro (mm)	Chiave
12,00-12,99	SD400-K05
13,00-14,99	SD400-K06
15,00-16,99	SD400-K07
17,00-18,99	SD400-K08
19,00-19,99	SD400-K09

SD403 – R7

Profondità di foratura ~ 3 x D – Codolo in pollici

Introduzione

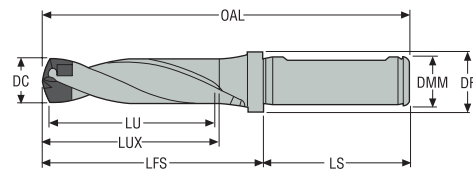

- Adduzione refrigerante interna
- ISO9766 per attacchi: Weldon 1835B, ISO 5414, DIN 60880
- Per i parametri di taglio raccomandati, vedere pagina(e) 219

Foratura

Codice di ordinazione	Codice prodotto	DC	LU	DF	OAL	LS	LFS	LUX	DMM
		<i>Inch</i>	<i>Inch</i>	<i>Inch</i>	<i>Inch</i>	<i>Inch</i>	<i>Inch</i>	<i>Inch</i>	<i>Inch</i>
SD403-12.00/12.49-38-0625R7	02622942	0.472-0.492	1.496	0.787	4.181	1.890	2.291	1.819	0.625
SD403-12.50/12.99-39-0625R7	02622943	0.492-0.511	1.535	0.787	4.252	1.890	2.362	1.870	0.625
SD403-13.00/13.99-42-0625R7	02622944	0.512-0.551	1.654	0.787	4.406	1.890	2.516	2.004	0.625
SD403-14.00/14.99-45-0625R7	02622945	0.551-0.590	1.772	0.787	4.587	1.890	2.697	2.146	0.625
SD403-15.00/15.99-48-0625R7	02622946	0.591-0.630	1.890	0.787	4.772	1.890	2.882	2.291	0.625
SD403-16.00/16.99-51-0750R7	02622947	0.630-0.669	2.008	0.945	5.035	1.969	3.067	2.437	0.750
SD403-17.00/17.99-54-0750R7	02622948	0.669-0.708	2.126	0.945	5.220	1.969	3.252	2.583	0.750
SD403-18.00/18.99-57-0750R7	02622949	0.709-0.748	2.244	0.945	5.406	1.969	3.437	2.728	0.750
SD403-19.00/19.99-60-0750R7	02622950	0.748-0.787	2.362	0.945	5.591	1.969	3.622	2.874	0.750

Alesatura

Accessori

Per punta diametro (pollici)	Chiave
0.472-0.511	SD400-K05
0.512-0.590	SD400-K06
0.591-0.669	SD400-K07
0.669-0.748	SD400-K08
0.748-0.787	SD400-K09



Barenatura

Allegato

SD403 – R1

Profondità di foratura ~ 3 x D – Codolo metrico

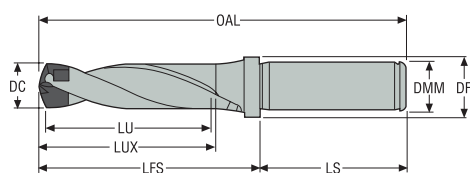

- Adduzione refrigerante interna
- Il codolo cilindrico (R1) è adatto agli attacchi: 5834/HC/HCR/HCS e 5672
- Per i parametri di taglio raccomandati, vedere pagina(e) 219

Codice di ordinazione	Codice prodotto	DC	LU	OAL	LUX	LFS	LS	DMM	DF
		mm	mm	mm	mm	mm	mm	mm	mm
SD403-12.00/12.49-38-16R1	02622920	12,0-12,49	38,0	106,2	46,2	58,2	48,0	16,0	20,0
SD403-12.50/12.99-39-16R1	02622921	12,5-12,99	39,0	108,0	47,5	60,0	48,0	16,0	20,0
SD403-13.00/13.99-42-16R1	02622922	13,0-13,99	42,0	111,9	50,9	63,9	48,0	16,0	20,0
SD403-14.00/14.99-45-16R1	02622923	14,0-14,99	45,0	116,5	54,5	68,5	48,0	16,0	20,0
SD403-15.00/15.99-48-16R1	02622924	15,0-15,99	48,0	121,2	58,2	73,2	48,0	16,0	20,0
SD403-16.00/16.99-51-20R1	02622927	16,0-16,99	51,0	127,9	61,9	77,9	50,0	20,0	24,0
SD403-17.00/17.99-54-20R1	02622928	17,0-17,99	54,0	132,6	65,6	82,6	50,0	20,0	24,0
SD403-18.00/18.99-57-20R1	02622930	18,0-18,99	57,0	137,3	69,3	87,3	50,0	20,0	24,0
SD403-19.00/19.99-60-20R1	02622931	19,0-19,99	60,0	142,0	73,0	92,0	50,0	20,0	24,0

Accessori

Per punta diametro (mm)	Chiave
12,00-12,99	SD400-K05
13,00-14,99	SD400-K06
15,00-16,99	SD400-K07
17,00-18,99	SD400-K08
19,00-19,99	SD400-K09

SD403 – R1

Profondità di foratura ~ 3 x D – Codolo in pollici

Introduzione

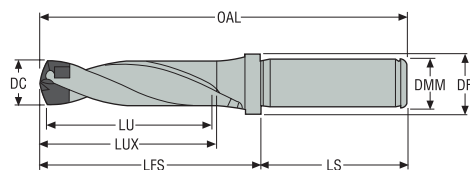

- Adduzione refrigerante interna
- Il codolo cilindrico (R1) è adatto agli attacchi: 5834/HC/HCR/HCS e 5672
- Per i parametri di taglio raccomandati, vedere pagina(e) 219

Foratura

Codice di ordinazione	Codice prodotto	DC	LU	DF	OAL	LS	LFS	LUX	DMM
		<i>Inch</i>	<i>Inch</i>	<i>Inch</i>	<i>Inch</i>	<i>Inch</i>	<i>Inch</i>	<i>Inch</i>	<i>Inch</i>
SD403-12.00/12.49-38-0625R1	02623538	0.472-0.492	1.496	0.787	4.181	1.890	2.291	1.819	0.625
SD403-12.50/12.99-39-0625R1	02623539	0.492-0.511	1.535	0.787	4.252	1.890	2.362	1.870	0.625
SD403-13.00/13.99-42-0625R1	02623540	0.512-0.551	1.654	0.787	4.406	1.890	2.516	2.004	0.625
SD403-14.00/14.99-45-0625R1	02623541	0.551-0.590	1.772	0.787	4.587	1.890	2.697	2.146	0.625
SD403-15.00/15.99-48-0625R1	02623542	0.591-0.630	1.890	0.787	4.772	1.890	2.882	2.291	0.625
SD403-16.00/16.99-51-0750R1	02623543	0.630-0.669	2.008	0.945	5.035	1.969	3.067	2.437	0.750
SD403-17.00/17.99-54-0750R1	02623544	0.669-0.708	2.126	0.945	5.220	1.969	3.252	2.583	0.750
SD403-18.00/18.99-57-0750R1	02623545	0.709-0.748	2.244	0.945	5.406	1.969	3.437	2.728	0.750
SD403-19.00/19.99-60-0750R1	02623546	0.748-0.787	2.362	0.945	5.591	1.969	3.622	2.874	0.750

Alesatura

Accessori

Per punta diametro (pollici)	Chiave
0.472-0.511	SD400-K05
0.512-0.590	SD400-K06
0.591-0.669	SD400-K07
0.669-0.748	SD400-K08
0.748-0.787	SD400-K09



Barenatura

Allegato

SD405 – R7

Profondità di foratura ~ 5 x D – Codolo metrico

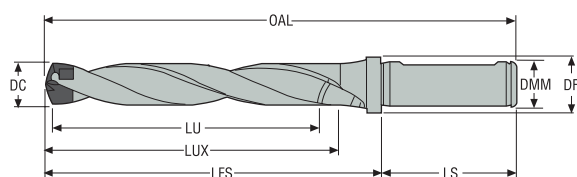

- Adduzione refrigerante interna
- ISO9766 per attacchi: Weldon 1835B, ISO 5414, DIN 60880
- Per i parametri di taglio raccomandati, vedere pagina(e) 220

Codice di ordinazione	Codice prodotto	DC	LU	OAL	LUX	LFS	LS	DMM	DF
		mm	mm	mm	mm	mm	mm	mm	mm
SD405-12.00/12.49-63-16R7	02623554	12,0-12,49	63,0	131,2	71,2	83,2	48,0	16,0	20,0
SD405-12.50/12.99-65-16R7	02623555	12,5-12,99	65,0	134,0	73,5	86,0	48,0	16,0	20,0
SD405-13.00/13.99-70-16R7	02623556	13,0-13,99	70,0	139,9	78,9	91,9	48,0	16,0	20,0
SD405-14.00/14.99-75-16R7	02623557	14,0-14,99	75,0	146,5	84,5	98,5	48,0	16,0	20,0
SD405-15.00/15.99-80-16R7	02623558	15,0-15,99	80,0	153,2	90,2	105,2	48,0	16,0	20,0
SD405-16.00/16.99-85-20R7	02623559	16,0-16,99	85,0	161,9	95,9	111,9	50,0	20,0	24,0
SD405-17.00/17.99-90-20R7	02623560	17,0-17,99	90,0	168,6	101,6	118,6	50,0	20,0	24,0
SD405-18.00/18.99-95-20R7	02623561	18,0-18,99	95,0	175,3	107,3	125,3	50,0	20,0	24,0
SD405-19.00/19.99-100-20R7	02623562	19,0-19,99	100,0	182,0	113,0	132,0	50,0	20,0	24,0

Accessori

Per punta diametro (mm)	Chiave
12,00-12,99	SD400-K05
13,00-14,99	SD400-K06
15,00-16,99	SD400-K07
17,00-18,99	SD400-K08
19,00-19,99	SD400-K09

SD405 – R7

Profondità di foratura ~ 5 x D – Codolo in pollici

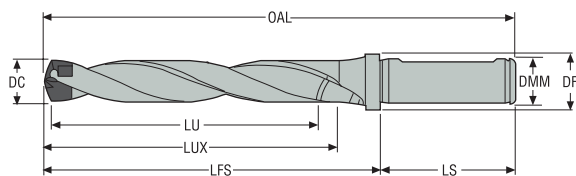

- Adduzione refrigerante interna
- ISO9766 per attacchi: Weldon 1835B, ISO 5414, DIN 60880
- Per i parametri di taglio raccomandati, vedere pagina(e) 220

Codice di ordinazione	Codice prodotto	DC	LU	DF	OAL	LS	LFS	LUX	DMM
		<i>Inch</i>	<i>Inch</i>	<i>Inch</i>	<i>Inch</i>	<i>Inch</i>	<i>Inch</i>	<i>Inch</i>	<i>Inch</i>
SD405-12.00/12.49-63-0625R7	02623586	0.472-0.492	2.480	0.787	5.165	1.890	3.276	2.803	0.625
SD405-12.50/12.99-65-0625R7	02623587	0.492-0.511	2.559	0.787	5.276	1.890	3.386	2.894	0.625
SD405-13.00/13.99-70-0625R7	02623588	0.512-0.551	2.756	0.787	5.508	1.890	3.618	3.106	0.625
SD405-14.00/14.99-75-0625R7	02623589	0.551-0.590	2.953	0.787	5.768	1.890	3.878	3.327	0.625
SD405-15.00/15.99-80-0625R7	02623590	0.591-0.630	3.150	0.787	6.031	1.890	4.142	3.551	0.625
SD405-16.00/16.99-85-0750R7	02623591	0.630-0.669	3.346	0.945	6.374	1.969	4.406	3.776	0.750
SD405-17.00/17.99-90-0750R7	02623592	0.669-0.708	3.543	0.945	6.638	1.969	4.669	4.000	0.750
SD405-18.00/18.99-95-0750R7	02623593	0.709-0.748	3.740	0.945	6.902	1.969	4.933	4.224	0.750
SD405-19.00/19.99-100-0750R7	02623594	0.748-0.787	3.937	0.945	7.165	1.969	5.197	4.449	0.750

Accessori

Per punta diametro (pollici)	Chiave
0.472-0.511	SD400-K05
0.512-0.590	SD400-K06
0.591-0.669	SD400-K07
0.669-0.748	SD400-K08
0.748-0.787	SD400-K09



Introduzione

Foratura

Alesatura

Barenatura

Allegato

SD405 – R1

Profondità di foratura ~ 5 x D – Codolo metrico

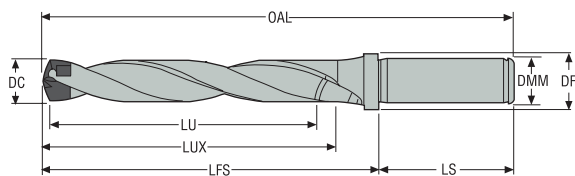

- Adduzione refrigerante interna
- Il codolo cilindrico (R1) è adatto agli attacchi: 5834/HC/HCR/HCS e 5672
- Per i parametri di taglio raccomandati, vedere pagina(e) 220

Codice di ordinazione	Codice prodotto	DC	LU	OAL	LUX	LFS	LS	DMM	DF
		mm	mm	mm	mm	mm	mm	mm	mm
SD405-12.00/12.49-63-16R1	02623570	12,0-12,49	63,0	131,2	71,2	83,2	48,0	16,0	20,0
SD405-12.50/12.99-65-16R1	02623571	12,5-12,99	65,0	134,0	73,5	86,0	48,0	16,0	20,0
SD405-13.00/13.99-70-16R1	02623572	13,0-13,99	70,0	139,9	78,9	91,9	48,0	16,0	20,0
SD405-14.00/14.99-75-16R1	02623573	14,0-14,99	75,0	146,5	84,5	98,5	48,0	16,0	20,0
SD405-15.00/15.99-80-16R1	02623574	15,0-15,99	80,0	153,2	90,2	105,2	48,0	16,0	20,0
SD405-16.00/16.99-85-20R1	02623575	16,0-16,99	85,0	161,9	95,9	111,9	50,0	20,0	24,0
SD405-17.00/17.99-90-20R1	02623576	17,0-17,99	90,0	168,6	101,6	118,6	50,0	20,0	24,0
SD405-18.00/18.99-95-20R1	02623577	18,0-18,99	95,0	175,3	107,3	125,3	50,0	20,0	24,0
SD405-19.00/19.99-100-20R1	02623578	19,0-19,99	100,0	182,0	113,0	132,0	50,0	20,0	24,0

Accessori

Per punta diametro (mm)	Chiave
12,00-12,99	SD400-K05
13,00-14,99	SD400-K06
15,00-16,99	SD400-K07
17,00-18,99	SD400-K08
19,00-19,99	SD400-K09

SD405 – R1

Profondità di foratura ~ 5 x D – Codolo in pollici

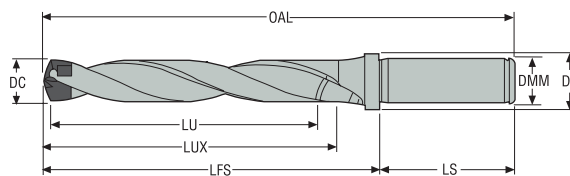

- Adduzione refrigerante interna
- Il codolo cilindrico (R1) è adatto agli attacchi: 5834/HC/HCR/HCS e 5672
- Per i parametri di taglio raccomandati, vedere pagina(e) 220

Codice di ordinazione	Codice prodotto	DC	LU	DF	OAL	LS	LFS	LUX	DMM
		<i>Inch</i>	<i>Inch</i>	<i>Inch</i>	<i>Inch</i>	<i>Inch</i>	<i>Inch</i>	<i>Inch</i>	<i>Inch</i>
SD405-12.00/12.49-63-0625R1	02623603	0.472-0.492	2.480	0.787	5.165	1.890	3.276	2.803	0.625
SD405-12.50/12.99-65-0625R1	02623604	0.492-0.511	2.559	0.787	5.276	1.890	3.386	2.894	0.625
SD405-13.00/13.99-70-0625R1	02623605	0.512-0.551	2.756	0.787	5.508	1.890	3.618	3.106	0.625
SD405-14.00/14.99-75-0625R1	02623606	0.551-0.590	2.953	0.787	5.768	1.890	3.878	3.327	0.625
SD405-15.00/15.99-80-0625R1	02623607	0.591-0.630	3.150	0.787	6.031	1.890	4.142	3.551	0.625
SD405-16.00/16.99-85-0750R1	02623608	0.630-0.669	3.346	0.945	6.374	1.969	4.406	3.776	0.750
SD405-17.00/17.99-90-0750R1	02623609	0.669-0.708	3.543	0.945	6.638	1.969	4.669	4.000	0.750
SD405-18.00/18.99-95-0750R1	02623610	0.709-0.748	3.740	0.945	6.902	1.969	4.933	4.224	0.750
SD405-19.00/19.99-100-0750R1	02623611	0.748-0.787	3.937	0.945	7.165	1.969	5.197	4.449	0.750

Accessori

Per punta diametro (pollici)	Chiave
0.472-0.511	SD400-K05
0.512-0.590	SD400-K06
0.591-0.669	SD400-K07
0.669-0.748	SD400-K08
0.748-0.787	SD400-K09



Introduzione

Foratura

Alesatura

Barenatura

Allegato

SD408 – R7

Profondità di foratura ~ 8 x D – Codolo metrico

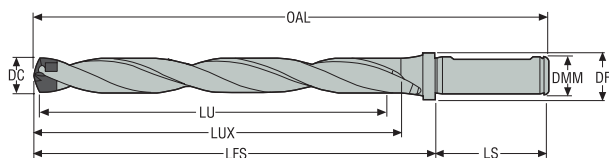

- Adduzione refrigerante interna
- ISO9766 per attacchi: Weldon 1835B, ISO 5414, DIN 60880
- Per i parametri di taglio raccomandati, vedere pagina(e) 221

Codice di ordinazione	Codice prodotto	DC	LU	OAL	LUX	LFS	LS	DMM	DF
		mm	mm	mm	mm	mm	mm	mm	mm
SD408-12.00/12.49-100-16R7	02623615	12,0-12,49	100,0	168,2	108,2	120,2	48,0	16,0	20,0
SD408-12.50/12.99-104-16R7	02623616	12,5-12,99	104,0	173,0	112,5	125,0	48,0	16,0	20,0
SD408-13.00/13.99-112-16R7	02623617	13,0-13,99	112,0	181,9	120,9	133,9	48,0	16,0	20,0
SD408-14.00/14.99-120-16R7	02623618	14,0-14,99	120,0	191,5	129,5	143,5	48,0	16,0	20,0
SD408-15.00/15.99-128-16R7	02623619	15,0-15,99	128,0	201,2	138,2	153,2	48,0	16,0	20,0
SD408-16.00/16.99-136-20R7	02623620	16,0-16,99	136,0	212,9	146,9	162,9	50,0	20,0	24,0
SD408-17.00/17.99-144-20R7	02623621	17,0-17,99	144,0	222,6	155,6	172,6	50,0	20,0	24,0
SD408-18.00/18.99-152-20R7	02623622	18,0-18,99	152,0	232,3	164,3	182,3	50,0	20,0	24,0
SD408-19.00/19.99-160-20R7	02623623	19,0-19,99	160,0	242,0	173,0	192,0	50,0	20,0	24,0

Accessori

Per punta diametro (mm)	Chiave
12,00-12,99	SD400-K05
13,00-14,99	SD400-K06
15,00-16,99	SD400-K07
17,00-18,99	SD400-K08
19,00-19,99	SD400-K09

SD408 – R7

Profondità di foratura ~ 8 x D – Codolo in pollici

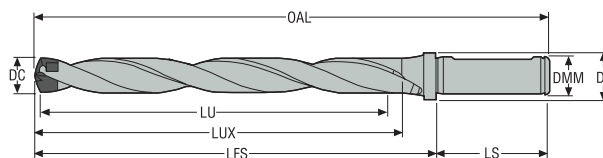

- Adduzione refrigerante interna
- ISO9766 per attacchi: Weldon 1835B, ISO 5414, DIN 60880
- Per i parametri di taglio raccomandati, vedere pagina(e) 221

Codice di ordinazione	Codice prodotto	DC	LU	DF	OAL	LS	LFS	LUX	DMM
		Inch	Inch	Inch	Inch	Inch	Inch	Inch	Inch
SD408-12.00/12.49-100-0625R7	02623639	0.472-0.492	3.937	0.787	6.622	1.890	4.732	4.260	0.625
SD408-12.50/12.99-104-0625R7	02623640	0.492-0.511	4.094	0.787	6.811	1.890	4.921	4.429	0.625
SD408-13.00/13.99-112-0625R7	02623641	0.512-0.551	4.409	0.787	7.161	1.890	5.272	4.760	0.625
SD408-14.00/14.99-120-0625R7	02623642	0.551-0.590	4.724	0.787	7.539	1.890	5.650	5.098	0.625
SD408-15.00/15.99-128-0625R7	02623643	0.591-0.630	5.039	0.787	7.921	1.890	6.031	5.441	0.625
SD408-16.00/16.99-136-0750R7	02623644	0.630-0.669	5.354	0.945	8.382	1.969	6.413	5.783	0.750
SD408-17.00/17.99-144-0750R7	02623645	0.669-0.708	5.669	0.945	8.764	1.969	6.795	6.126	0.750
SD408-18.00/18.99-152-0750R7	02623646	0.709-0.748	5.984	0.945	9.146	1.969	7.177	6.469	0.750
SD408-19.00/19.99-160-0750R7	02623647	0.748-0.787	6.299	0.945	9.528	1.969	7.559	6.811	0.750

Accessori

Per punta diametro (pollici)	Chiave
0.472-0.511	SD400-K05
0.512-0.590	SD400-K06
0.591-0.669	SD400-K07
0.669-0.748	SD400-K08
0.748-0.787	SD400-K09



SD408 – R1

Profondità di foratura ~ 8 x D – Codolo metrico

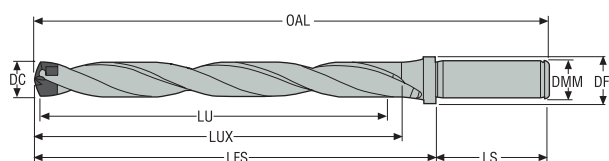

- Adduzione refrigerante interna
- Il codolo cilindrico (R1) è adatto agli attacchi: 5834/HC/HCR/HCS e 5672
- Per i parametri di taglio raccomandati, vedere pagina(e) 221

Codice di ordinazione	Codice prodotto	DC	LU	OAL	LUX	LFS	LS	DMM	DF
		mm	mm	mm	mm	mm	mm	mm	mm
SD408-12.00/12.49-100-16R1	02623627	12,0-12,49	100,0	168,2	108,2	120,2	48,0	16,0	20,0
SD408-12.50/12.99-104-16R1	02623628	12,5-12,99	104,0	173,0	112,5	125,0	48,0	16,0	20,0
SD408-13.00/13.99-112-16R1	02623629	13,0-13,99	112,0	181,9	120,9	133,9	48,0	16,0	20,0
SD408-14.00/14.99-120-16R1	02623630	14,0-14,99	120,0	191,5	129,5	143,5	48,0	16,0	20,0
SD408-15.00/15.99-128-16R1	02623631	15,0-15,99	128,0	201,2	138,2	153,2	48,0	16,0	20,0
SD408-16.00/16.99-136-20R1	02623632	16,0-16,99	136,0	212,9	146,9	162,9	50,0	20,0	24,0
SD408-17.00/17.99-144-20R1	02623633	17,0-17,99	144,0	222,6	155,6	172,6	50,0	20,0	24,0
SD408-18.00/18.99-152-20R1	02623634	18,0-18,99	152,0	232,3	164,3	182,3	50,0	20,0	24,0
SD408-19.00/19.99-160-20R1	02623635	19,0-19,99	160,0	242,0	173,0	192,0	50,0	20,0	24,0

Accessori

Per punta diametro (mm)	Chiave
12,00-12,99	SD400-K05
13,00-14,99	SD400-K06
15,00-16,99	SD400-K07
17,00-18,99	SD400-K08
19,00-19,99	SD400-K09

SD408 – R1

Profondità di foratura ~ 8 x D – Codolo in pollici

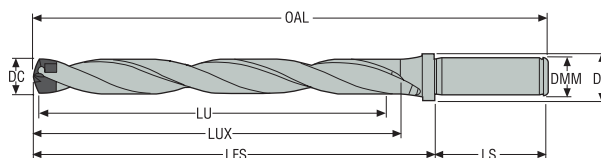

- Adduzione refrigerante interna
- Il codolo cilindrico (R1) è adatto agli attacchi: 5834/HC/HCR/HCS e 5672
- Per i parametri di taglio raccomandati, vedere pagina(e) 221

Codice di ordinazione	Codice prodotto	DC	LU	DF	OAL	LS	LFS	LUX	DMM
		Inch	Inch	Inch	Inch	Inch	Inch	Inch	Inch
SD408-12.00/12.49-100-0625R1	02623651	0.472-0.492	3.937	0.787	6.622	1.890	4.732	4.260	0.625
SD408-12.50/12.99-104-0625R1	02623652	0.492-0.511	4.094	0.787	6.811	1.890	4.921	4.429	0.625
SD408-13.00/13.99-112-0625R1	02623653	0.512-0.551	4.409	0.787	7.161	1.890	5.272	4.760	0.625
SD408-14.00/14.99-120-0625R1	02623654	0.551-0.590	4.724	0.787	7.539	1.890	5.650	5.098	0.625
SD408-15.00/15.99-128-0625R1	02623655	0.591-0.630	5.039	0.787	7.921	1.890	6.031	5.441	0.625
SD408-16.00/16.99-136-0750R1	02623656	0.630-0.669	5.354	0.945	8.382	1.969	6.413	5.783	0.750
SD408-17.00/17.99-144-0750R1	02623657	0.669-0.708	5.669	0.945	8.764	1.969	6.795	6.126	0.750
SD408-18.00/18.99-152-0750R1	02623658	0.709-0.748	5.984	0.945	9.146	1.969	7.177	6.469	0.750
SD408-19.00/19.99-160-0750R1	02623659	0.748-0.787	6.299	0.945	9.528	1.969	7.559	6.811	0.750

Accessori

Per punta diametro (pollici)	Chiave
0.472-0.511	SD400-K05
0.512-0.590	SD400-K06
0.591-0.669	SD400-K07
0.669-0.748	SD400-K08
0.748-0.787	SD400-K09



Modulo per smussi

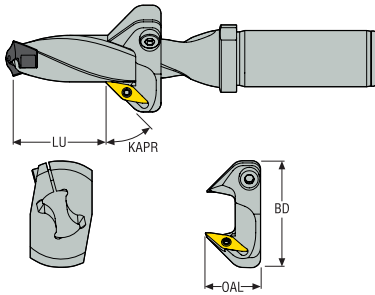

Codice di ordinazione	Codice prodotto	Per corpo punta	LU profondità di foratura						Max profondità smusso (mm)	OAL	BD	KAPR°
			SD403 (min-max)		SD405 (min-max)		SD408 (min-max)					
			mm Inch	mm Inch	mm Inch	mm Inch	mm Inch	mm Inch				
SD400-C45-12.00/12.49	02846075	SD40x-12.00/12.49	6,0 0.236	22,0 0.866	6,0 0.236	47,0 1.850	47,0 1.850	84,0 3.307	1,5 0.059	20,0 0.787	34,0 1.339	45
SD400-C45-12.50/12.99	02846076	SD40x-12.50/12.99	7,0 0.276	23,0 0.906	7,0 0.276	48,0 1.890	48,0 1.890	88,0 3.465	1,5 0.059	20,0 0.787	34,0 1.339	45
SD400-C45-13.00/13.99	02846077	SD40x-13.00/13.99	7,0 0.276	27,0 1.063	7,0 0.276	55,0 2.165	55,0 2.165	97,0 3.819	1,5 0.059	20,0 0.787	34,0 1.339	45
SD400-C45-14.00/14.99	02846078	SD40x-14.00/14.99	7,0 0.276	33,0 1.299	7,0 0.276	60,0 2.362	60,0 2.362	105,0 4.134	1,5 0.059	20,0 0.787	36,0 1.417	45
SD400-C45-15.00/15.99	02846079	SD40x-15.00/15.99	8,0 0.315	35,0 1.378	8,0 0.315	67,0 2.638	67,0 2.638	114,0 4.488	1,5 0.059	20,0 0.787	36,0 1.417	45
SD400-C45-16.00/16.99	02846080	SD40x-16.00/16.99	8,0 0.315	38,0 1.496	8,0 0.315	72,0 2.835	72,0 2.835	123,0 4.843	1,5 0.059	20,0 0.787	38,0 1.496	45
SD400-C45-17.00/17.99	02846117	SD40x-17.00/17.99	9,0 0.354	43,0 1.693	9,0 0.354	79,0 3.110	79,0 3.110	132,0 5.197	1,5 0.059	20,0 0.787	38,0 1.496	45
SD400-C45-18.00/18.99	02846082	SD40x-18.00/18.99	9,0 0.354	45,0 1.772	9,0 0.354	83,0 3.268	83,0 3.268	140,0 5.512	1,5 0.059	20,0 0.787	40,0 1.575	45
SD400-C45-19.00/19.99	02846083	SD40x-19.00/19.99	10,0 0.394	49,0 1.929	10,0 0.394	89,0 3.504	89,0 3.504	149,0 5.866	1,5 0.059	20,0 0.787	40,0 1.575	45

Parti di ricambio, comprese nella fornitura

Per punta diametro (mm)	Chiave per vite inserto	Vite di bloccaggio inserto	Chiave di bloccaggio	Chiave di bloccaggio	Vite di bloccaggio 1	Vite di bloccaggio 2
SD400-C45...	T07P-2	C02505-T07P	2SMS795	3SMS795	MC6S4X8	P6SS4X8

Inserto

Tolleranze: mm/inch	Dimensione	L mm/inch	EPSR	RE mm/inch	IC mm/inch	D1 mm/inch	AN	S mm/inch
<p>IC = ±0,025/0.0009842 S = ±0,071/0.0027559 RE = ±0,10/0.0039370</p>	09	9,0/2187	35°	0,2/0078	5,556/2187	2,9/1141	7°	2,5/0984
Qualità: T400D								
Descrizione: VCGX090202-D1								
Codice prodotto: 00014948								

Corone – Geometria -P e -M

Angolo di punta 140°



Codice di ordinazione	Codice prodotto	Geometria -P per acciaio	Geometria -M per acciaio inossidabile e leghe per alte temperature	DC	
				mm	inch
SD400-12.00-M	02826210	-	■	12,0	0.472
SD400-12.00-P	02630908	■	-	12,0	0.472
SD400-12.10-P	02630910	■	-	12,1	0.476
SD400-12.20-P	02630911	■	-	12,2	0.480
SD400-12.30-M	02826211	-	■	12,3	0.484
SD400-12.30-P	02630912	■	-	12,3	0.484
SD400-12.41-M	02826212	-	■	12,41	0.489
SD400-12.41-P	02630913	■	-	12,41	0.489
SD400-12.50-M	02826213	-	■	12,5	0.492
SD400-12.50-P	02630915	■	-	12,5	0.492
SD400-12.60-P	02630916	■	-	12,6	0.496
SD400-12.70-M	02826214	-	■	12,7	0.500
SD400-12.70-P	02630917	■	-	12,7	0.500
SD400-12.80-M	02826215	-	■	12,8	0.504
SD400-12.80-P	02630918	■	-	12,8	0.504
SD400-12.90-M	02826216	-	■	12,9	0.508
SD400-12.90-P	02630919	■	-	12,9	0.508
SD400-13.00-M	02826217	-	■	13,0	0.512
SD400-13.00-P	02634577	■	-	13,0	0.512
SD400-13.10-M	02826218	-	■	13,1	0.516
SD400-13.10-P	02634578	■	-	13,1	0.516
SD400-13.20-P	02634579	■	-	13,2	0.520
SD400-13.30-M	02826219	-	■	13,3	0.524
SD400-13.30-P	02634580	■	-	13,3	0.524
SD400-13.50-M	02826220	-	■	13,5	0.531
SD400-13.50-P	02634581	■	-	13,5	0.531
SD400-13.70-M	02826221	-	■	13,7	0.539
SD400-13.70-P	02634582	■	-	13,7	0.539
SD400-13.80-M	02826222	-	■	13,8	0.543
SD400-13.80-P	02634583	■	-	13,8	0.543
SD400-13.89-M	02826223	-	■	13,89	0.547
SD400-13.89-P	02634584	■	-	13,89	0.547
SD400-14.00-M	02826224	-	■	14,0	0.551
SD400-14.00-P	02634589	■	-	14,0	0.551
SD400-14.10-P	02634590	■	-	14,1	0.555
SD400-14.20-M	02826225	-	■	14,2	0.559
SD400-14.20-P	02634591	■	-	14,2	0.559
SD400-14.288-M	02826226	-	■	14,29	0.563
SD400-14.288-P	02634592	■	-	14,288	0.563

Codice di ordinazione	Codice prodotto	Geometria -P per acciaio	Geometria -M per acciaio inossidabile e leghe per alte temperature	DC	
				mm	inch
SD400-14.40-P	02634593	■	-	14,4	0.567
SD400-14.50-M	02826227	-	■	14,5	0.571
SD400-14.50-P	02634594	■	-	14,5	0.571
SD400-14.68-M	02826228	-	■	14,68	0.578
SD400-14.68-P	02634595	■	-	14,68	0.578
SD400-14.70-M	02826229	-	■	14,7	0.579
SD400-14.70-P	02634596	■	-	14,7	0.579
SD400-14.80-M	02826230	-	■	14,8	0.583
SD400-14.80-P	02634597	■	-	14,8	0.583
SD400-14.90-M	02826231	-	■	14,9	0.587
SD400-14.90-P	02634598	■	-	14,9	0.587
SD400-15.00-M	02826232	-	■	15,0	0.591
SD400-15.00-P	02634599	■	-	15,0	0.591
SD400-15.08-M	02826233	-	■	15,08	0.594
SD400-15.08-P	02634600	■	-	15,08	0.594
SD400-15.10-P	02634601	■	-	15,1	0.594
SD400-15.20-P	02634602	■	-	15,2	0.598
SD400-15.25-M	02826234	-	■	15,25	0.600
SD400-15.25-P	02634603	■	-	15,25	0.600
SD400-15.478-M	02826235	-	■	15,48	0.609
SD400-15.478-P	02634604	■	-	15,478	0.609
SD400-15.50-M	02826236	-	■	15,5	0.610
SD400-15.50-P	02634605	■	-	15,5	0.610
SD400-15.70-M	02826237	-	■	15,7	0.618
SD400-15.70-P	02634607	■	-	15,7	0.618
SD400-15.80-M	02826238	-	■	15,8	0.622
SD400-15.80-P	02634608	■	-	15,8	0.622
SD400-15.875-M	02826239	-	■	15,88	0.625
SD400-15.875-P	02634609	■	-	15,875	0.625
SD400-16.00-M	02826240	-	■	16,0	0.630
SD400-16.00-P	02635956	■	-	16,0	0.630
SD400-16.10-P	02635957	■	-	16,1	0.634
SD400-16.20-P	02635958	■	-	16,2	0.638
SD400-16.25-P	02635959	■	-	16,25	0.640
SD400-16.27-M	02826241	-	■	16,27	0.641
SD400-16.27-P	02635960	■	-	16,27	0.641
SD400-16.40-P	02635962	■	-	16,4	0.646
SD400-16.50-M	02826242	-	■	16,5	0.650
SD400-16.50-P	02635963	■	-	16,5	0.650
SD400-16.669-M	02826243	-	■	16,67	0.656
SD400-16.669-P	02635964	■	-	16,669	0.656
SD400-16.70-M	02826244	-	■	16,7	0.657
SD400-16.70-P	02635966	■	-	16,7	0.657
SD400-16.80-M	02826245	-	■	16,8	0.661
SD400-16.80-P	02635968	■	-	16,8	0.661
SD400-16.90-P	02635969	■	-	16,9	0.665
SD400-17.00-M	02826246	-	■	17,0	0.669
SD400-17.00-P	02635970	■	-	17,0	0.669
SD400-17.065-M	02826247	-	■	17,07	0.672
SD400-17.065-P	02635972	■	-	17,065	0.672
SD400-17.10-P	02635973	■	-	17,1	0.673

Introduzione

Foratura

Alesatura

Barenatura

Allegato

	Codice di ordinazione	Codice prodotto	Geometria -P per acciaio	Geometria -M per acciaio inossidabile e leghe per alte temperature	DC	
					mm	inch
Introduzione	SD400-17.20-P	02635974	■	-	17,2	0.677
	SD400-17.35-P	02888828	■	-	17,35	0.683
	SD400-17.463-M	02826248	-	■	17,46	0.687
	SD400-17.463-P	02635975	■	-	17,463	0.688
	SD400-17.50-M	02826249	-	■	17,5	0.689
	SD400-17.50-P	02635976	■	-	17,5	0.689
	SD400-17.70-M	02826250	-	■	17,7	0.697
	SD400-17.70-P	02635977	■	-	17,7	0.697
Foratura	SD400-17.80-M	02826251	-	■	17,8	0.701
	SD400-17.80-P	02635978	■	-	17,8	0.701
	SD400-17.859-M	02826252	-	■	17,86	0.703
	SD400-17.859-P	02635979	■	-	17,859	0.703
	SD400-17.90-M	02826253	-	■	17,9	0.705
	SD400-17.90-P	02635980	■	-	17,9	0.705
	SD400-18.00-M	02826254	-	■	18,0	0.709
	SD400-18.00-P	02635981	■	-	18,0	0.709
	SD400-18.10-P	02635982	■	-	18,1	0.713
	SD400-18.20-P	02635983	■	-	18,2	0.717
	SD400-18.256-M	02826255	-	■	18,26	0.719
	SD400-18.256-P	02635984	■	-	18,256	0.719
	SD400-18.50-M	02826256	-	■	18,5	0.728
	SD400-18.50-P	02635985	■	-	18,5	0.728
	SD400-18.653-M	02826257	-	■	18,65	0.734
	SD400-18.653-P	02635986	■	-	18,653	0.734
Alesatura	SD400-18.70-M	02826258	-	■	18,7	0.736
	SD400-18.70-P	02635987	■	-	18,7	0.736
	SD400-18.80-M	02826259	-	■	18,8	0.740
	SD400-18.80-P	02635988	■	-	18,8	0.740
	SD400-18.90-M	02826260	-	■	18,9	0.744
	SD400-18.90-P	02635989	■	-	18,9	0.744
	SD400-19.00-M	02826261	-	■	19,0	0.748
	SD400-19.00-P	02635991	■	-	19,0	0.748
	SD400-19.05-M	02826262	-	■	19,05	0.750
	SD400-19.05-P	02635992	■	-	19,05	0.750
Barenatura	SD400-19.10-P	02635993	■	-	19,1	0.752
	SD400-19.20-M	02826263	-	■	19,2	0.756
	SD400-19.20-P	02635995	■	-	19,2	0.756
	SD400-19.447-M	02826264	-	■	19,45	0.766
	SD400-19.447-P	02635997	■	-	19,447	0.766
	SD400-19.50-M	02826265	-	■	19,5	0.768
	SD400-19.50-P	02635998	■	-	19,5	0.768
	SD400-19.70-M	02826266	-	■	19,7	0.776
	SD400-19.70-P	02635999	■	-	19,7	0.776
	SD400-19.80-M	02826267	-	■	19,8	0.780
Allegato	SD400-19.80-P	02636000	■	-	19,8	0.780
	SD400-19.844-M	02826268	-	■	19,84	0.781
	SD400-19.844-P	02636001	■	-	19,844	0.781
	SD400-19.90-M	02826269	-	■	19,9	0.783
	SD400-19.90-P	02636002	■	-	19,9	0.783

■ Prodotto standard.

SMG		f					v _c
		Ø12,00 Ø 0.472	Ø14,00 Ø 0.551	Ø16,00 Ø 0.630	Ø18,00 Ø 0.709	Ø20,00 Ø 0.787	
P1	P	0,30	0,32	0,34	0,36	0,36	155
	P	0.012	0.013	0.013	0.014	0.014	510
P2	P	0,30	0,32	0,34	0,36	0,38	150
	P	0.012	0.013	0.013	0.014	0.015	490
P3	P	0,28	0,30	0,32	0,34	0,36	130
	P	0.011	0.012	0.013	0.013	0.014	425
P4	P	0,28	0,30	0,32	0,34	0,34	115
	P	0.011	0.012	0.013	0.013	0.013	375
P5	P	0,28	0,30	0,32	0,32	0,34	110
	P	0.011	0.012	0.013	0.013	0.013	360
P6	P	0,28	0,30	0,30	0,32	0,34	120
	P	0.011	0.012	0.012	0.013	0.013	395
P7	P	0,28	0,30	0,30	0,32	0,34	115
	P	0.011	0.012	0.012	0.013	0.013	375
P8	P	0,28	0,30	0,32	0,34	0,36	110
	P	0.011	0.012	0.013	0.013	0.014	360
P11	P	0,28	0,30	0,30	0,32	0,34	110
	P	0.011	0.012	0.012	0.013	0.013	360
P12	P	0,19	0,20	0,22	0,22	0,24	65
	P	0.0075	0.0080	0.0085	0.0085	0.0095	215
M1	M	0,17	0,19	0,20	0,22	0,22	95
	M	0.0065	0.0075	0.0080	0.0085	0.0085	310
M2	M	0,16	0,17	0,18	0,19	0,20	80
	M	0.0065	0.0065	0.0070	0.0075	0.0080	260
M3	M	0,13	0,14	0,14	0,15	0,16	60
	M	0.0050	0.0055	0.0055	0.0060	0.0065	195
M4	M	0,11	0,12	0,13	0,13	0,14	45
	M	0.0044	0.0048	0.0050	0.0050	0.0055	150
M5	M	0,11	0,12	0,13	0,13	0,14	37
	M	0.0044	0.0048	0.0050	0.0050	0.0055	120
K1	P	0,28	0,30	0,32	0,34	0,36	110
	P	0.011	0.012	0.013	0.013	0.014	360
K2	P	0,26	0,28	0,30	0,32	0,32	95
	P	0.010	0.011	0.012	0.013	0.013	310
K3	P	0,26	0,28	0,30	0,32	0,32	80
	P	0.010	0.011	0.012	0.013	0.013	260
K4	P	0,26	0,28	0,30	0,32	0,32	75
	P	0.010	0.011	0.012	0.013	0.013	245
K5	P	0,24	0,25	0,26	0,28	0,30	45
	P	0.0095	0.010	0.010	0.011	0.012	150
N2	M	0,26	0,28	0,30	0,32	0,34	215
	M	0.010	0.011	0.012	0.013	0.013	710
N3	M	0,26	0,28	0,30	0,32	0,34	145
	M	0.010	0.011	0.012	0.013	0.013	475
N11	M	0,26	0,28	0,30	0,32	0,34	170
	M	0.010	0.011	0.012	0.013	0.013	560
S1	M	0,095	0,11	0,12	0,13	0,13	34
	M	0.0038	0.0044	0.0048	0.0050	0.0050	110
S2	M	0,095	0,11	0,12	0,13	0,13	24
	M	0.0038	0.0044	0.0048	0.0050	0.0050	80
S3	M	0,095	0,11	0,12	0,13	0,13	24
	M	0.0038	0.0044	0.0048	0.0050	0.0050	80
S11	M	0,16	0,17	0,19	0,20	0,22	65
	M	0.0065	0.0065	0.0075	0.0080	0.0085	215
S12	M	0,16	0,17	0,19	0,20	0,22	49
	M	0.0065	0.0065	0.0075	0.0080	0.0085	160
S13	M	0,14	0,15	0,17	0,18	0,19	38
	M	0.0055	0.0060	0.0065	0.0070	0.0075	125
H3	P	0,12	0,13	0,14	0,15	0,15	32
	P	0.0048	0.0050	0.0055	0.0060	0.0060	105
H5	P	0,19	0,20	0,22	0,22	0,24	60
	P	0.0075	0.0080	0.0085	0.0085	0.0095	195
H7	P	0,12	0,13	0,14	0,15	0,15	32
	P	0.0048	0.0050	0.0055	0.0060	0.0060	105
H8	P	0,14	0,15	0,16	0,17	0,18	60
	P	0.0055	0.0060	0.0065	0.0065	0.0070	195
H11	P	0,19	0,20	0,22	0,22	0,24	75
	P	0.0075	0.0080	0.0085	0.0085	0.0095	245
H12	P	0,14	0,15	0,16	0,17	0,18	39
	P	0.0055	0.0060	0.0065	0.0065	0.0070	130
H21	P	0,14	0,15	0,16	0,17	0,18	60
	P	0.0055	0.0060	0.0065	0.0065	0.0070	195

SMG = Gruppo materiale Seco

f = mm/giro

v_c = m/min

Tutti i parametri di taglio sono valori di partenza

Introduzione

Foratura

Alesatura

Barenatura

Allegato

Foratura

Crownloc® Plus – Parametri di taglio



SD405 – Ø 12-20 mm / 0.472-0.787 pollici

SMG		f					V _c
		Ø 12,00 Ø 0.472	Ø 14,00 Ø 0.551	Ø 16,00 Ø 0.630	Ø 18,00 Ø 0.709	Ø 20,00 Ø 0.787	
P1	P	0,30	0,32	0,34	0,36	0,36	125
	P	0.012	0.013	0.013	0.014	0.014	410
P2	P	0,30	0,32	0,34	0,36	0,38	120
	P	0.012	0.013	0.013	0.014	0.015	395
P3	P	0,28	0,30	0,32	0,34	0,36	105
	P	0.011	0.012	0.013	0.013	0.014	345
P4	P	0,28	0,30	0,32	0,34	0,34	95
	P	0.011	0.012	0.013	0.013	0.013	310
P5	P	0,28	0,30	0,32	0,32	0,34	90
	P	0.011	0.012	0.013	0.013	0.013	295
P6	P	0,28	0,30	0,30	0,32	0,34	100
	P	0.011	0.012	0.012	0.013	0.013	330
P7	P	0,28	0,30	0,30	0,32	0,34	95
	P	0.011	0.012	0.012	0.013	0.013	310
P8	P	0,28	0,30	0,32	0,34	0,36	90
	P	0.011	0.012	0.013	0.013	0.014	295
P11	P	0,28	0,30	0,30	0,32	0,34	90
	P	0.011	0.012	0.012	0.013	0.013	295
P12	P	0,19	0,20	0,22	0,22	0,24	55
	P	0.0075	0.0080	0.0085	0.0085	0.0095	180
M1	M	0,17	0,19	0,20	0,22	0,22	80
	M	0.0065	0.0075	0.0080	0.0085	0.0085	260
M2	M	0,16	0,17	0,18	0,19	0,20	65
	M	0.0065	0.0065	0.0070	0.0075	0.0080	215
M3	M	0,13	0,14	0,14	0,15	0,16	49
	M	0.0050	0.0055	0.0055	0.0060	0.0065	160
M4	M	0,11	0,12	0,13	0,13	0,14	37
	M	0.0044	0.0048	0.0050	0.0050	0.0055	120
M5	M	0,11	0,12	0,13	0,13	0,14	31
	M	0.0044	0.0048	0.0050	0.0050	0.0055	100
K1	P	0,28	0,30	0,32	0,34	0,36	90
	P	0.011	0.012	0.013	0.013	0.014	295
K2	P	0,26	0,28	0,30	0,32	0,32	75
	P	0.010	0.011	0.012	0.013	0.013	245
K3	P	0,26	0,28	0,30	0,32	0,32	65
	P	0.010	0.011	0.012	0.013	0.013	215
K4	P	0,26	0,28	0,30	0,32	0,32	60
	P	0.010	0.011	0.012	0.013	0.013	195
K5	P	0,24	0,25	0,26	0,28	0,30	37
	P	0.0095	0.010	0.010	0.011	0.012	120
N2	M	0,26	0,28	0,30	0,32	0,34	175
	M	0.010	0.011	0.012	0.013	0.013	570
N3	M	0,26	0,28	0,30	0,32	0,34	120
	M	0.010	0.011	0.012	0.013	0.013	395
N11	M	0,26	0,28	0,30	0,32	0,34	140
	M	0.010	0.011	0.012	0.013	0.013	460
S1	M	0,095	0,11	0,12	0,13	0,13	28
	M	0.0038	0.0044	0.0048	0.0050	0.0050	90
S2	M	0,095	0,11	0,12	0,13	0,13	20
	M	0.0038	0.0044	0.0048	0.0050	0.0050	65
S3	M	0,095	0,11	0,12	0,13	0,13	20
	M	0.0038	0.0044	0.0048	0.0050	0.0050	65
S11	M	0,16	0,17	0,19	0,20	0,22	50
	M	0.0065	0.0065	0.0075	0.0080	0.0085	165
S12	M	0,16	0,17	0,19	0,20	0,22	40
	M	0.0065	0.0065	0.0075	0.0080	0.0085	130
S13	M	0,14	0,15	0,17	0,18	0,19	31
	M	0.0055	0.0060	0.0065	0.0070	0.0075	100
H3	P	0,12	0,13	0,14	0,15	0,15	26
	P	0.0048	0.0050	0.0055	0.0060	0.0060	85
H5	P	0,19	0,20	0,22	0,22	0,24	49
	P	0.0075	0.0080	0.0085	0.0085	0.0095	160
H7	P	0,12	0,13	0,14	0,15	0,15	26
	P	0.0048	0.0050	0.0055	0.0060	0.0060	85
H8	P	0,14	0,15	0,16	0,17	0,18	49
	P	0.0055	0.0060	0.0065	0.0065	0.0070	160
H11	P	0,19	0,20	0,22	0,22	0,24	60
	P	0.0075	0.0080	0.0085	0.0085	0.0095	195
H12	P	0,14	0,15	0,16	0,17	0,18	32
	P	0.0055	0.0060	0.0065	0.0065	0.0070	105
H21	P	0,14	0,15	0,16	0,17	0,18	49
	P	0.0055	0.0060	0.0065	0.0065	0.0070	160

SMG = Gruppo materiale Seco

f = mm/giro

v_c = m/min

Tutti i parametri di taglio sono valori di partenza

SMG		f					v _c
		Ø 12,00 Ø 0.472	Ø 14,00 Ø 0.551	Ø 16,00 Ø 0.630	Ø 18,00 Ø 0.709	Ø 20,00 Ø 0.787	
P1	P	0,30	0,32	0,34	0,36	0,36	100
	P	0,012	0,013	0,013	0,014	0,014	330
P2	P	0,30	0,32	0,34	0,36	0,38	100
	P	0,012	0,013	0,013	0,014	0,015	330
P3	P	0,28	0,30	0,32	0,34	0,36	85
	P	0,011	0,012	0,013	0,013	0,014	280
P4	P	0,28	0,30	0,32	0,34	0,34	75
	P	0,011	0,012	0,013	0,013	0,013	245
P5	P	0,28	0,30	0,32	0,32	0,34	70
	P	0,011	0,012	0,013	0,013	0,013	230
P6	P	0,28	0,30	0,30	0,32	0,34	80
	P	0,011	0,012	0,012	0,013	0,013	260
P7	P	0,28	0,30	0,30	0,32	0,34	75
	P	0,011	0,012	0,012	0,013	0,013	245
P8	P	0,28	0,30	0,32	0,34	0,36	70
	P	0,011	0,012	0,013	0,013	0,014	230
P11	P	0,28	0,30	0,30	0,32	0,34	75
	P	0,011	0,012	0,012	0,013	0,013	245
P12	P	0,19	0,20	0,22	0,22	0,24	43
	P	0,0075	0,0080	0,0085	0,0085	0,0095	140
M1	M	0,17	0,19	0,20	0,22	0,22	65
	M	0,0065	0,0075	0,0080	0,0085	0,0085	215
M2	M	0,16	0,17	0,18	0,19	0,20	50
	M	0,0065	0,0065	0,0070	0,0075	0,0080	165
M3	M	0,13	0,14	0,14	0,15	0,16	39
	M	0,0050	0,0055	0,0055	0,0060	0,0065	130
M4	M	0,11	0,12	0,13	0,13	0,14	29
	M	0,0044	0,0048	0,0050	0,0050	0,0055	95
M5	M	0,11	0,12	0,13	0,14	0,14	24
	M	0,0044	0,0048	0,0050	0,0050	0,0055	80
K1	P	0,28	0,30	0,32	0,34	0,36	70
	P	0,011	0,012	0,013	0,013	0,014	230
K2	P	0,26	0,28	0,30	0,32	0,32	60
	P	0,010	0,011	0,012	0,013	0,013	195
K3	P	0,26	0,28	0,30	0,32	0,32	50
	P	0,010	0,011	0,012	0,013	0,013	165
K4	P	0,26	0,28	0,30	0,32	0,32	49
	P	0,010	0,011	0,012	0,013	0,013	160
K5	P	0,24	0,25	0,26	0,28	0,30	29
	P	0,0095	0,010	0,010	0,011	0,012	95
N2	M	0,26	0,28	0,30	0,32	0,34	140
	M	0,010	0,011	0,012	0,013	0,013	460
N3	M	0,26	0,28	0,30	0,32	0,34	95
	M	0,010	0,011	0,012	0,013	0,013	310
N11	M	0,26	0,28	0,30	0,32	0,34	110
	M	0,010	0,011	0,012	0,013	0,013	360
S1	M	0,095	0,11	0,12	0,13	0,13	22
	M	0,0038	0,0044	0,0048	0,0050	0,0050	70
S2	M	0,095	0,11	0,12	0,13	0,13	16
	M	0,0038	0,0044	0,0048	0,0050	0,0050	50
S3	M	0,095	0,11	0,12	0,13	0,13	16
	M	0,0038	0,0044	0,0048	0,0050	0,0050	50
S11	M	0,16	0,17	0,19	0,20	0,22	42
	M	0,0065	0,0065	0,0075	0,0080	0,0085	140
S12	M	0,16	0,17	0,19	0,20	0,22	32
	M	0,0065	0,0065	0,0075	0,0080	0,0085	105
S13	M	0,14	0,15	0,17	0,18	0,19	25
	M	0,0055	0,0060	0,0065	0,0070	0,0075	80
H3	P	0,12	0,13	0,14	0,15	0,15	21
	P	0,0048	0,0050	0,0055	0,0060	0,0060	70
H5	P	0,19	0,20	0,22	0,22	0,24	39
	P	0,0075	0,0080	0,0085	0,0085	0,0095	130
H7	P	0,12	0,13	0,14	0,15	0,15	21
	P	0,0048	0,0050	0,0055	0,0060	0,0060	70
H8	P	0,14	0,15	0,16	0,17	0,18	39
	P	0,0055	0,0060	0,0065	0,0065	0,0070	130
H11	P	0,19	0,20	0,22	0,22	0,24	49
	P	0,0075	0,0080	0,0085	0,0085	0,0095	160
H12	P	0,14	0,15	0,16	0,17	0,18	26
	P	0,0055	0,0060	0,0065	0,0065	0,0070	85
H21	P	0,14	0,15	0,16	0,17	0,18	39
	P	0,0055	0,0060	0,0065	0,0065	0,0070	130

SMG = Gruppo materiale Seco

f = mm/giro

v_c = m/min

Tutti i parametri di taglio sono valori di partenza

Introduzione

Foratura

Alesatura

Barenatura

Allegato

Informazioni applicative

Informazioni applicative

Superficie lavorata

Nessuna pre-foratura e nessun avanzamento d'ingresso necessari usando SD403 e SD405. Quando si usa una punta SD408, è sempre raccomandata una pre-foratura. (Prima di usare una punta SD405 su acciaio inossidabile potrebbe essere necessaria un'operazione di pre-foratura).

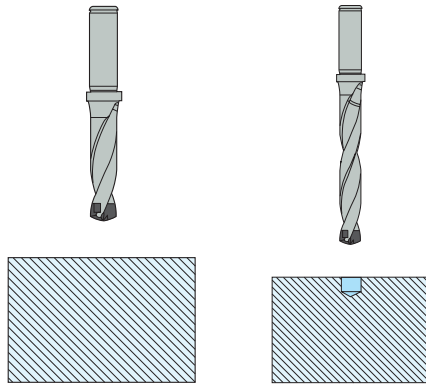

Foratura a pacco

È possibile eseguire forature a pacco solo se i pezzi sono saldamente serrati l'uno contro l'altro, così da non avere interstizi tra le parti. Gli interstizi possono influenzare l'evacuazione dei trucioli e quindi danneggiare la punta.

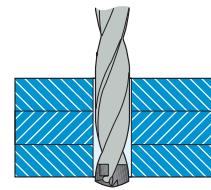

Foro con entrata irregolare/inclinata

Se il foro ha entrata irregolare o inclinata, effettuare le pre-lavorazioni necessarie. Quando si fora con punta $> 3 \times D$, è raccomandata una pre-foratura con una punta standard, ad esempio SD403.

Alternative di pre-lavorazione

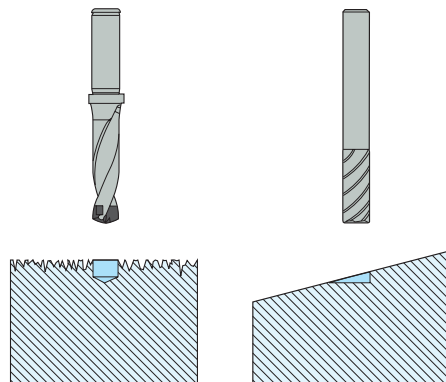

Foro con entrata irregolare

Creare un piano utilizzando una fresa integrale della gamma Seco.

Foro con entrata inclinata

Raccomandazioni sul refrigerante

Pressione del refrigerante

Pressione minima del refrigerante raccomandata 10 bar (145 PSI) con $\leq 3 \times D$
Pressione minima del refrigerante raccomandata 30 bar (435 PSI) con $> 3 \times D$

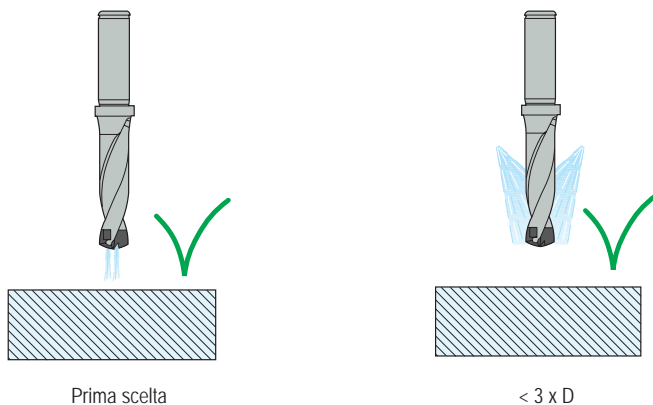

Prima scelta

$< 3 \times D$

Composizione del refrigerante

Percentuale di olio nell'emulsione raccomandata: 6-8%. Quando si forano acciaio inossidabile, superleghe ed acciai ad alta resistenza, si consiglia di utilizzare una concentrazione del 10%

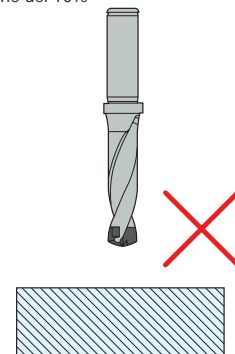

Parametri di lavorazione

I valori dei grafici variano in funzione dei parametri di taglio, dei materiali, dell'efficienza della macchina e dell'usura dell'utensile.
I grafici sono validi per foratura del gruppo materiale Seco (SMG) P5-P6 e per una velocità di taglio di 90 m/min (295 sf/min).

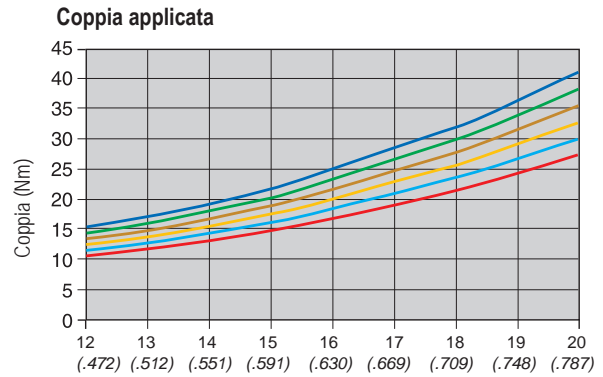
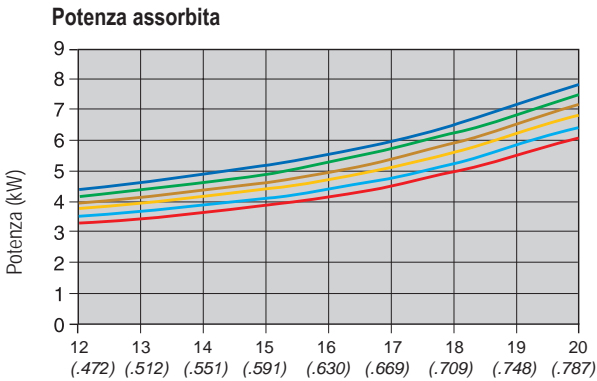

Diametro punta mm / pollici

f = 0,32 (0.013") f = 0,24 (0.009")
f = 0,30 (0.012") f = 0,22 (0.0086")
f = 0,27 (0.011") f = 0,20 (0.0078")

Diametro punta mm / pollici

f = 0,32 (0.013") f = 0,24 (0.009")
f = 0,30 (0.012") f = 0,22 (0.0086")
f = 0,27 (0.011") f = 0,20 (0.0078")

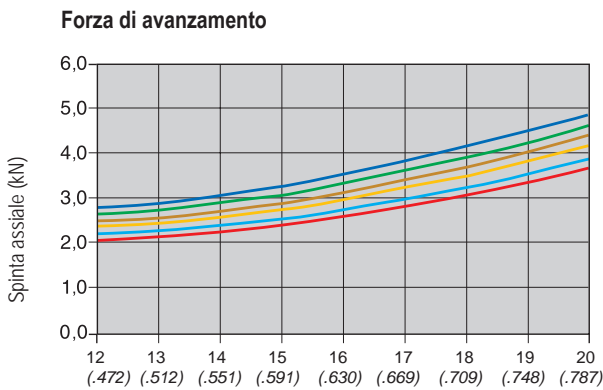

Portata refrigerante a diverse pressioni

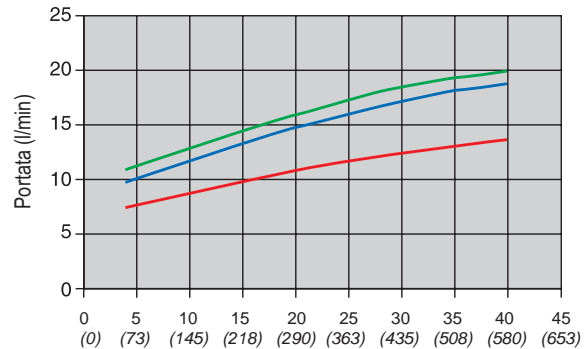

Diametro punta mm / pollici

f = 0,32 (0.013") f = 0,24 (0.009")
f = 0,30 (0.012") f = 0,22 (0.0086")
f = 0,27 (0.011") f = 0,20 (0.0078")

Pressione del refrigerante in bar (PSI)

Ø 17-19,99 mm (0.67-0.79")
Ø 14-16,99 mm (0.55-0.67")
Ø 12-13,99 mm (0.47-0.55")

Portata refrigerante raccomandata Dx1 l/min

Portata refrigerante minima D/2 l/min

D = Diametro punta

Pressione refrigerante minima raccomandata: 10 bar (145 PSI) con $\leq 3 \times D$

Pressione refrigerante minima raccomandata: 20 bar (290 PSI) con $\leq 5 \times D$

Pressione refrigerante minima raccomandata: 40 bar (580 PSI) con $> 5 \times D$

Composizione del refrigerante

Percentuale di olio nell'emulsione raccomandata: 6-8%.

Per forare acciaio inossidabile, superleghe ed acciai ad alta resistenza, si consiglia di utilizzare una concentrazione del 10%.

Tolleranza del foro/Finitura superficiale

SD403, SD405 e SD408					
IT9-10 / R _a 1-4*, R _a 39-157 µin*					
Ø punta DC (mm)	Tolleranza IT9 (µm)	Tolleranza IT10 (µm)	Ø Punta DC (pollici)	Tolleranza IT9 (pollici)	Tolleranza IT10 (pollici)
10-18	0 - +43	0 - +70	0 - +0.394-0.709	0 - +0.0017	0 - +0.0028
18-30	0 - +52	0 - +84	0 - +0.709-1.181	0 - +0.0020	0 - +0.0033

*Quando si forano acciai inossidabili e acciai a basso tenore di carbonio, si può verificare un deterioramento della finitura superficiale e della tolleranza del foro. Per la migliore qualità del foro, impiegare la punta più corta possibile.

Problemi e soluzioni – Verifiche iniziali:

- Stabilità del fissaggio
- Condizioni del mandrino macchina
- Condizioni del portautensile
- Bloccaggio dell'utensile:
 - Eccentricità entro 0,06 TIR

- Evacuazione del truciolo:
 - Parametri di taglio
- Refrigerante:
 - Pressione
 - Flusso
 - Concentrazione

<p>Scheggiature del tagliente</p> <ul style="list-style-type: none"> • Ridurre l'avanzamento/giro • In presenza di vibrazioni, ridurre la velocità di taglio ed aumentare l'avanzamento • Quando si forano superfici grezze, dure o inclinate, ridurre l'avanzamento del 30-50% in fase di entrata e di uscita 		<p>Tolleranza diametro non soddisfacente</p> <ul style="list-style-type: none"> • Aumentare l'avanzamento/giro • Utilizzare una punta in metallo duro integrale Seco Feedmax, vedere le pagine 15-17 • Effettuare un'operazione di alesatura, vedere le pagine 327 • Effettuare un'operazione di barenatura, vedere le pagine 516-517 	
<p>Rapida usura del tagliente</p> <ul style="list-style-type: none"> • Verificare che si utilizzi la giusta geometria • Ridurre la velocità di taglio 		<p>Cattiva finitura superficiale</p> <ul style="list-style-type: none"> • Ridurre l'avanzamento/giro • Aumentare la velocità di taglio • Verificare che si utilizzi la giusta geometria • Utilizzare una punta in metallo duro integrale Seco Feedmax, vedere le pagine 15-17 • Effettuare un'operazione di alesatura, vedere pagina 327 	
<p>Usura ad intaglio</p> <ul style="list-style-type: none"> • Ridurre l'avanzamento al giro • Ridurre la velocità di taglio • Aumentare la percentuale di olio nel refrigerante 		<p>Posizione foro non soddisfacente</p> <ul style="list-style-type: none"> • Ridurre l'avanzamento/giro • Quando si forano superfici grezze, dure o inclinate, ridurre l'avanzamento del 30-50% in fase di entrata e uscita • Preforare con un angolo punta a 140° • Utilizzare una punta in metallo duro integrale Seco Feedmax, vedere le pagine 15-17 • Effettuare un'operazione di barenatura, vedere le pagine 516-517 	
<p>Usura dei bordini esterni</p> <ul style="list-style-type: none"> • Verificare che si utilizzi la giusta geometria • Ridurre la velocità di taglio • Aumentare la concentrazione del refrigerante • Quando si forano superfici grezze, dure o inclinate, ridurre l'avanzamento del 30-50% in fase di entrata e di uscita 		<p>Trucioli lunghi che causano problemi di evacuazione</p> <ul style="list-style-type: none"> • Aumentare l'avanzamento • Per materiali che producono trucioli lunghi, gruppi materiale P1-P4, M1-M2: <ul style="list-style-type: none"> - Aumentare la velocità di taglio e diminuire l'avanzamento/giro - Utilizzare la geometria L 	







Perfomax®

Perfomax® è una gamma di punte ad inserti intercambiabili, che offre una soluzione di foratura produttiva e conveniente.

- Inserti quadri a quattro taglienti
- Qualità e geometrie dedicate ai diversi materiali da lavorare
- Corpo punta caratterizzato da un esclusivo design dell'elica, con adduzione interna del refrigerante per un'evacuazione ottimale del truciolo

Panoramica della gamma

Perfomax®	Gamma ∅	Profondità di foratura	Tolleranza ∅ punta	Tolleranza foro
SD522  Pagine 232, 233, 234, 235-240, 241, 242	15-59 mm (0.594-2.375")	~ 2 x D	+/- 0,1 mm (+/- 0.004")	+0/+ 0,2 mm (+0/+ 0.008")
SD523  Pagine 243, 244, 245, 246-259, 260, 261	15-59 mm (0.594-2.375")	~ 3 x D	+/- 0,1 mm (+/- 0.004")	+0/+ 0,3 mm (+0/+ 0.012")
SD524  Pagine 262, 263, 264-275, 276	17-59 mm (0.594-2.375")	~ 4 x D	+/- 0,1 mm (+/- 0.004")	+ 0,4 mm (+0/+ 0.016")
SD525  Pagine 277, 278-279	19-45 mm (0.750-2.000")	~ 5 x D	+/- 0,1 mm (+/- 0.004")	+0/+ 0,5 mm (+0/+ 0.020")
SD542  Pagine 280-281	60-85 mm (2.250-3.500")	~ 2.5 x D	+/- 0,1 mm (+/- 0.004")	+0/+ 0,2 mm (+0/+ 0.008")

Introduzione



Foratura

Alesatura

Barenatura

Allegato

Panoramica della gamma

Perfomax®	Gamma ∅	Profondità di foratura	Tolleranza ∅ punta	Tolleranza foro
SD572  Pagine 282, 283	15-47 mm (0.591"-1.850")	~ 2 x D	+/- 0,1 mm (+/- 0.004")	+0/+ 0,2 mm (+0/+ 0.008")
SD602  Pagine 287-291	60-160 mm (2.5"-4.000")	~ 1-10 x D	+/- 0,2 mm (+/- 0.008")	-

Introduzione

Foratura

Alesatura

Barenatura

Allegato

Chiavi di codifica - Punta ad inserti sostituibili

Misure metriche

SD522 - **20** - **40** - **25** - **R** - **7**

Diametro punta (point diameter) → 20
 Diametro stelo (shank diameter) → 25
 Rotazione destra (right rotation) → R
 Profondità di foratura (drilling depth) → 40

Tipo di punta (tip type):
 SD522: 2 x D
 SD523: 3 x D
 SD524: 4 x D
 SD525: 5 x D
 SD542: 2,5 x D
 SD572: 2 x D

Tipo di attacco (attachment type):
 2. Compatibile ABS
 7. ISO 9766
 8. Compatibile VDI
 G. Graflex

Pollici

SD522 - **0750** - **150** - **1000** - **R** - **7** - **C**

Diametro punta (point diameter) → 0750
 Diametro stelo (shank diameter) → 1000
 Rotazione destra (right rotation) → R
 Applicazione C. Utensile non rotante (Application C. Non-rotating tool) → C
 Profondità di foratura (drilling depth) → 150

Tipo di punta (tip type):
 SD522: 2 x D
 SD523: 3 x D
 SD524: 4 x D
 SD525: 5 x D
 SD542: 2,5 x D
 SD572: 2 x D

Tipo di attacco (attachment type):
 2. Compatibile ABS
 7. ISO 9766
 8. Compatibile VDI
 G. Graflex

Capto™

SD523 - **20** - **60** - **C5**

Diametro punta (point diameter) → 20
 Connessione per Capto: C4, C5, C6 → C5
 Profondità di foratura (drilling depth) → 60

Tipo di punta (tip type):
 SD523: 3 x D
 SD524: 4 x D

Steli

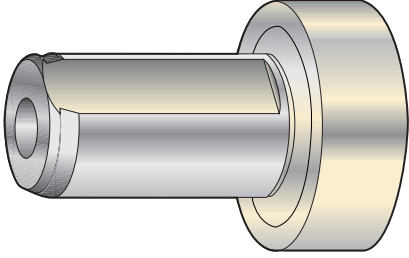
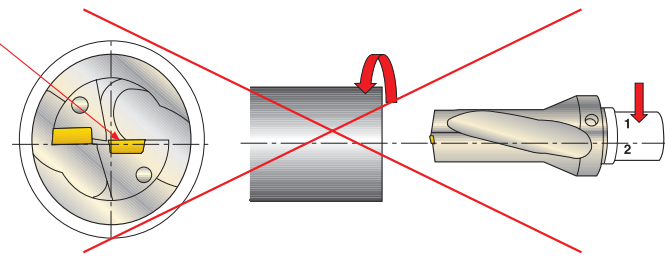
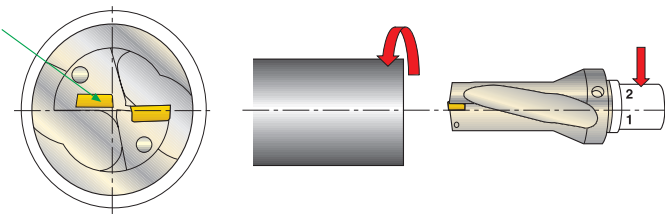
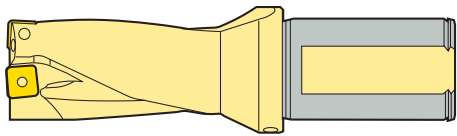
Steli	
<p>-R7</p> 	<p>ISO 9766 Idoneo per la maggior parte dei mandrini sul mercato:</p> <ul style="list-style-type: none"> • Weldon 1835B • ISO 5414 • DIN 69880 <p>Adduzione refrigerante dalla parte posteriore della punta.</p>
<p>R7 e R7-C</p> 	<p>Steli con due o quattro piani Tagliente dell'inserto centrale sotto la linea centrale del pezzo.</p> <p>Per applicazioni non rotanti:</p> <ul style="list-style-type: none"> • Le nuove punte dispongono di attacco cilindrico con 2 piani di bloccaggio per la massima flessibilità di impiego su tornio. • In queste applicazioni, il centro di rotazione del pezzo e il centro punta devono essere perfettamente allineati. • In caso contrario, l'inserto centrale potrebbe trovarsi sopra la mezzeria del pezzo causando il cattivo funzionamento della punta.
 <p>Il secondo piano di bloccaggio dà invece la possibilità di ruotare la punta di 180° per compensare il disallineamento in modo semplice e rapido.</p>	<p>Steli con quattro piani Tagliente dell'inserto centrale sopra la linea centrale del pezzo.</p>
	<p>NOTA!</p> <ul style="list-style-type: none"> • Se una punta con attacco -7 è montata su di un mandrino registrabile Seco, occorre impiegare il piano di bloccaggio localizzato dalla parte dell'inserto centrale. • In caso contrario, la regolazione diametrale avverrebbe nel senso opposto a quella voluta.

Steli

Introduzione

Seco-Capto

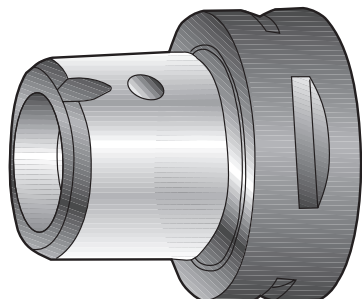

Seco-Capto C4, C5, C6

- Flessibile - Possibilità di utilizzare il medesimo attacco su diverse macchine.
- Modulare - Possibilità di creare utensili con adattatori estensibili.
- Trasmissione di coppia elevata - Il carico di coppia viene distribuito in modo simmetrico.
- Elevata rigidità - Il tipo di montaggio garantisce l'assenza di gioco nell'accoppiamento.
- Precisione - L'attacco conico poligonale garantisce la resistenza e l'autocentraggio della giunzione entro 2 micron.

Foratura

Graflex

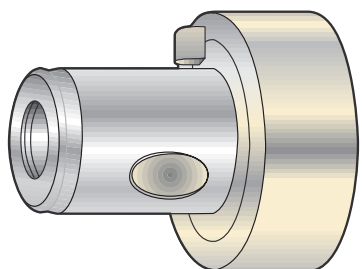

- G

- Si monta direttamente in attacchi Graflex con due viti di bloccaggio a testa sferica a 120°.
- Assemblati modulari che offrono rigidità e una buona eccentricità.
- Connessione cilindro/piano - elevata precisione
- Montaggio/smontaggio dei moduli rapido e semplice per un'elevata flessibilità.
- Adduzione refrigerante dalla parte posteriore della punta.

Alesatura

ABS 50 (compatibile)

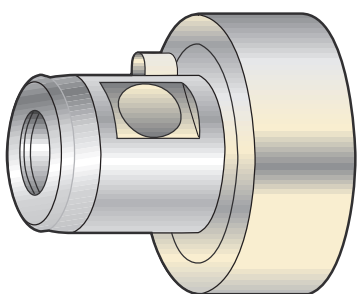

- 2

- Attacco compatibile ABS 50.
- Si monta direttamente in attacchi ABS 50 con una vite di bloccaggio.
- Adduzione refrigerante dalla parte posteriore della punta.

Barenatura

VDI 30 e VDI 40 (compatibili)



- 8

- Attacco compatibile VDI.
- Montaggio diretto nel mandrino per:
 - VDI 3425 bl.2
 - DIN 69880

NOTA!

L'anello adduzione refrigerante deve essere ordinato separatamente.

Allegato

Attacchi – Anello adduzione refrigerante

VDI 30				VDI 40					
Profondità di foratura	Diametro punta		Accessori Anello refrigerante	Profondità di foratura	Diametro punta		Grano	Vite di bloccaggio	Accessori Anello refrigerante
	mm	pollici			mm	pollici			
2 x D	15-31	0,591-1,220	SDA5-30R8	2 x D	15-31	0,591-1,220			SDA5-40R8
3 x D	15-31	0,591-1,220	SDA5-30R8	3 x D	15-31	0,591-1,220			SDA5-40R8
4 x D	17-31	0,669-1,220	SDA5-30R8	4 x D	17-31	0,669-1,220			SDA5-40R8
5 x D	19-31	0,748-1,220	SDA5-30R8	5 x D	19-31	0,748-1,220			SDA5-40R8
				2 x D	41-59	1,614-2,323	R1/4"	P6SS8x8	SDA5-40R8
				3 x D	41-59	1,614-2,323	R1/4"	P6SS8x8	SDA5-40R8

1. Montare l'anello sulla punta senza serrare la vite laterale.

2. Bloccare la punta sulla torretta.

3. Serrare la vite sull'anello di adduzione refrigerante.

Anello adduzione refrigerante

TCEI 0825

Introduzione

Foratura

Alesatura

Barenatura

Allegato

SD522

Profondità di foratura ~ 2 x D – Misure metriche/Pollici

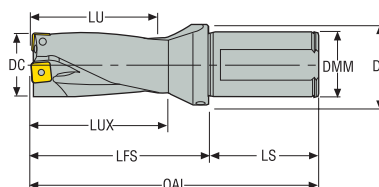

- Codolo ISO 9766, -7
- Adduzione refrigerante interna
- Per le informazioni sugli inserti, vedere pagina(e) 297-303
- Per i parametri di taglio raccomandati, vedere pagina(e) 304, 305
- Per i diametri intermedi, utilizzare MyDesign.

Codice di ordinazione	Codice prodotto	DC	LU	OAL	LUX	LFS	LS	DMM	DF	Inserto		Regolazione radiale	
										Inserto centrale	Inserto periferico	mm - Inch -	mm + Inch +
SD522-15-30-20R7	03080744	15,0 0.591	30,0 1.181	110,0 4.331	35,0 1.378	60,0 2.362	50,0 1.969	20,0 0.787	30,0 1.181	SPGX0502	SCGX050204	0,22 0.009	0,31 0.012
SD522-15-30-25R7	03080745	15,0 0.591	30,0 1.181	116,0 4.567	35,0 1.378	60,0 2.362	56,0 2.205	25,0 0.984	35,0 1.378	SPGX0502	SCGX050204	0,22 0.009	0,31 0.012
SD522-15.5-31-20R7	03080740	15,5 0.610	31,0 1.220	111,0 4.370	36,0 1.417	61,0 2.402	50,0 1.969	20,0 0.787	30,0 1.181	SPGX0502	SCGX050204	0,17 0.007	0,36 0.014
SD522-15.5-31-25R7	03080741	15,5 0.610	31,0 1.220	117,0 4.606	36,0 1.417	61,0 2.402	56,0 2.205	25,0 0.984	35,0 1.378	SPGX0502	SCGX050204	0,17 0.007	0,36 0.014
SD522-16-32-20R7	03080749	16,0 0.630	32,0 1.260	112,0 4.409	37,0 1.457	62,0 2.441	50,0 1.969	20,0 0.787	30,0 1.181	SPGX0502	SCGX050204	0,12 0.005	0,41 0.016
SD522-16-32-25R7	03080750	16,0 0.630	32,0 1.260	118,0 4.646	37,0 1.457	62,0 2.441	56,0 2.205	25,0 0.984	35,0 1.378	SPGX0502	SCGX050204	0,12 0.005	0,41 0.016
SD522-16.5-33-20R7	03080746	16,5 0.650	33,0 1.299	113,0 4.449	38,0 1.496	63,0 2.480	50,0 1.969	20,0 0.787	30,0 1.181	SPGX0502	SCGX050204	0,07 0.003	0,46 0.018
SD522-16.5-33-25R7	03080747	16,5 0.650	33,0 1.299	119,0 4.685	38,0 1.496	63,0 2.480	56,0 2.205	25,0 0.984	35,0 1.378	SPGX0502	SCGX050204	0,07 0.003	0,46 0.018
SD522-17-34-20R7	03080754	17,0 0.669	34,0 1.339	114,0 4.488	39,0 1.535	64,0 2.520	50,0 1.969	20,0 0.787	30,0 1.181	SPGX0502	SCGX050204	0,02 0.001	0,5 0.020
SD522-17-34-25R7	03080755	17,0 0.669	34,0 1.339	120,0 4.724	39,0 1.535	64,0 2.520	56,0 2.205	25,0 0.984	35,0 1.378	SPGX0502	SCGX050204	0,02 0.001	0,5 0.020
SD522-17.5-35-20R7	03080752	17,5 0.689	35,0 1.378	115,0 4.528	40,0 1.575	65,0 2.559	50,0 1.969	20,0 0.787	30,0 1.181	SPGX0602	SCGX050204	0,43 0.017	0,1 0.004
SD522-17.5-35-25R7	03080753	17,5 0.689	35,0 1.378	121,0 4.764	40,0 1.575	65,0 2.559	56,0 2.205	25,0 0.984	35,0 1.378	SPGX0602	SCGX050204	0,43 0.017	0,1 0.004
SD522-18-36-20R7	03080760	18,0 0.709	36,0 1.417	116,0 4.567	41,0 1.614	66,0 2.598	50,0 1.969	20,0 0.787	30,0 1.181	SPGX0602	SCGX050204	0,32 0.013	0,21 0.008
SD522-18-36-25R7	03080761	18,0 0.709	36,0 1.417	122,0 4.803	41,0 1.614	66,0 2.598	56,0 2.205	25,0 0.984	35,0 1.378	SPGX0602	SCGX050204	0,32 0.013	0,21 0.008
SD522-18.5-37-20R7	03080758	18,5 0.728	37,0 1.457	117,0 4.606	42,0 1.654	67,0 2.638	50,0 1.969	20,0 0.787	30,0 1.181	SPGX0602	SCGX050204	0,22 0.009	0,31 0.012
SD522-18.5-37-25R7	03080759	18,5 0.728	37,0 1.457	123,0 4.843	42,0 1.654	67,0 2.638	56,0 2.205	25,0 0.984	35,0 1.378	SPGX0602	SCGX050204	0,22 0.009	0,31 0.012
SD522-19-38-20R7	03080765	19,0 0.748	38,0 1.496	118,0 4.646	43,0 1.693	68,0 2.677	50,0 1.969	20,0 0.787	30,0 1.181	SPGX0602	SCGX050204	0,11 0.004	0,42 0.017
SD522-19-38-25R7	03080766	19,0 0.748	38,0 1.496	124,0 4.882	43,0 1.693	68,0 2.677	56,0 2.205	25,0 0.984	35,0 1.378	SPGX0602	SCGX050204	0,11 0.004	0,42 0.017
SD522-19.5-39-20R7	03080764	19,5 0.768	39,0 1.535	119,0 4.685	44,0 1.732	69,0 2.717	50,0 1.969	20,0 0.787	30,0 1.181	SPGX0602	SCGX060204	0,11 0.004	0,42 0.017
SD522-20-40-25R7	03080771	20,0 0.787	40,0 1.575	126,0 4.961	45,0 1.772	70,0 2.756	56,0 2.205	25,0 0.984	35,0 1.378	SPGX0602	SCGX060204	0,07 0.003	0,46 0.018
SD522-21-42-25R7	03080775	21,0 0.827	42,0 1.654	128,0 5.039	47,0 1.850	72,0 2.835	56,0 2.205	25,0 0.984	35,0 1.378	SPGX0602	SCGX060204	0,01 0	0,5 0.020
SD522-22-44-25R7	03080777	22,0 0.866	44,0 1.732	130,0 5.118	49,0 1.929	74,0 2.913	56,0 2.205	25,0 0.984	35,0 1.378	SPGX0703	SCGX060204	0,44 0.017	0,46 0.018

Introduzione

Foratura

Alesatura

Barenatura

Allegato

Codice di ordinazione	Codice prodotto	DC	LU	OAL	LUX	LFS	LS	DMM	DF	Insero		Regolazione radiale	
		mm Inch	mm Inch	mm Inch	mm Inch	mm Inch	mm Inch	mm Inch	mm Inch	Insero centrale	Insero periferico	mm - Inch -	mm + Inch +
SD522-23-46-25R7	03080781	23,0 0.906	46,0 1.811	132,0 5.197	51,0 2.008	76,0 2.992	56,0 2.205	25,0 0.984	35,0 1.378	SPGX0703	SCGX070308	0,33 0.013	0,5 0.020
SD522-23.5-47-25R7	03192517	23,5 0.925	47,0 1.850	133,0 5.236	52,0 2.047	77,0 3.031	56,0 2.205	25,0 0.984	35,0 1.378	SPGX0703	SCGX070308	0,23 0.009	0,5 0.020
SD522-24-48-25R7	03080785	24,0 0.945	48,0 1.890	134,0 5.276	53,0 2.087	78,0 3.071	56,0 2.205	25,0 0.984	35,0 1.378	SPGX0703	SCGX070308	0,11 0.004	0,5 0.020
SD522-25-50-32R7	03080788	25,0 0.984	50,0 1.969	140,0 5.512	55,0 2.165	80,0 3.150	60,0 2.362	32,0 1.260	42,0 1.654	SPGX0703	SCGX070308	0,11 0.004	0,5 0.020
SD522-26-52-32R7	03080790	26,0 1.024	52,0 2.047	142,0 5.591	57,0 2.244	82,0 3.228	60,0 2.362	32,0 1.260	42,0 1.654	SPGX0903	SCGX070308	0,5 0.020	0,11 0.004
SD522-27-54-32R7	03080792	27,0 1.063	54,0 2.126	144,0 5.669	59,0 2.323	84,0 3.307	60,0 2.362	32,0 1.260	42,0 1.654	SPGX0903	SCGX070308	0,5 0.020	0,26 0.010
SD522-28-56-32R7	03080795	28,0 1.102	56,0 2.205	146,0 5.748	61,0 2.402	86,0 3.386	60,0 2.362	32,0 1.260	42,0 1.654	SPGX0903	SCGX070308	0,28 0.011	0,5 0.020
SD522-29-58-32R7	03080796	29,0 1.142	58,0 2.283	148,0 5.827	63,0 2.480	88,0 3.465	60,0 2.362	32,0 1.260	42,0 1.654	SPGX0903	SCGX09T308	0,18 0.007	0,5 0.020
SD522-30-60-32R7	03080798	30,0 1.181	60,0 2.362	150,0 5.906	65,0 2.559	90,0 3.543	60,0 2.362	32,0 1.260	42,0 1.654	SPGX0903	SCGX09T308	0,12 0.005	0,5 0.020
SD522-31-62-32R7	03080801	31,0 1.220	62,0 2.441	152,0 5.984	67,0 2.638	92,0 3.622	60,0 2.362	32,0 1.260	42,0 1.654	SPGX0903	SCGX09T308	0,12 0.005	0,5 0.020
SD522-32-64-32R7	03080802	32,0 1.260	64,0 2.520	154,0 6.063	69,0 2.717	94,0 3.701	60,0 2.362	32,0 1.260	42,0 1.654	SPGX11T3	SCGX09T308	0,5 0.020	0,31 0.012
SD522-32-64-40R7	03080803	32,0 1.260	64,0 2.520	162,0 6.378	69,0 2.717	94,0 3.701	68,0 2.677	40,0 1.575	50,0 1.969	SPGX11T3	SCGX09T308	0,5 0.020	0,31 0.012
SD522-33-66-32R7	03080805	33,0 1.299	66,0 2.598	156,0 6.142	71,0 2.795	96,0 3.780	60,0 2.362	32,0 1.260	42,0 1.654	SPGX11T3	SCGX09T308	0,5 0.020	0,46 0.018
SD522-33-66-40R7	03080806	33,0 1.299	66,0 2.598	164,0 6.457	71,0 2.795	96,0 3.780	68,0 2.677	40,0 1.575	50,0 1.969	SPGX11T3	SCGX09T308	0,5 0.020	0,46 0.018
SD522-34-68-32R7	03080808	34,0 1.339	68,0 2.677	158,0 6.220	73,0 2.874	98,0 3.858	60,0 2.362	32,0 1.260	42,0 1.654	SPGX11T3	SCGX09T308	0,22 0.009	0,5 0.020
SD522-34-68-40R7	03080809	34,0 1.339	68,0 2.677	166,0 6.535	73,0 2.874	98,0 3.858	68,0 2.677	40,0 1.575	50,0 1.969	SPGX11T3	SCGX09T308	0,22 0.009	0,5 0.020
SD522-35-70-32R7	03080810	35,0 1.378	70,0 2.756	160,0 6.299	75,0 2.953	100,0 3.937	60,0 2.362	32,0 1.260	42,0 1.654	SPGX11T3	SCGX11T308	0,22 0.009	0,5 0.020
SD522-35-70-40R7	03080811	35,0 1.378	70,0 2.756	168,0 6.614	75,0 2.953	100,0 3.937	68,0 2.677	40,0 1.575	50,0 1.969	SPGX11T3	SCGX11T308	0,22 0.009	0,5 0.020
SD522-36-72-32R7	03080813	36,0 1.417	72,0 2.835	162,0 6.378	77,0 3.031	102,0 4.016	60,0 2.362	32,0 1.260	42,0 1.654	SPGX11T3	SCGX11T308	0,09 0.004	0,5 0.020
SD522-36-72-40R7	03080814	36,0 1.417	72,0 2.835	170,0 6.693	77,0 3.031	102,0 4.016	68,0 2.677	40,0 1.575	50,0 1.969	SPGX11T3	SCGX11T308	0,09 0.004	0,5 0.020
SD522-37-74-32R7	03080816	37,0 1.457	74,0 2.913	164,0 6.457	79,0 3.110	104,0 4.094	60,0 2.362	32,0 1.260	42,0 1.654	SPGX11T3	SCGX11T308	0,09 0.004	0,5 0.020
SD522-37-74-40R7	03080817	37,0 1.457	74,0 2.913	172,0 6.772	79,0 3.110	104,0 4.094	68,0 2.677	40,0 1.575	50,0 1.969	SPGX11T3	SCGX11T308	0,09 0.004	0,5 0.020
SD522-38-76-32R7	03080818	38,0 1.496	76,0 2.992	166,0 6.535	81,0 3.189	106,0 4.173	60,0 2.362	32,0 1.260	42,0 1.654	SPGX12T3	SCGX11T308	0,5 0.020	0,5 0.020
SD522-38-76-40R7	03080819	38,0 1.496	76,0 2.992	174,0 6.850	81,0 3.189	106,0 4.173	68,0 2.677	40,0 1.575	50,0 1.969	SPGX12T3	SCGX11T308	0,5 0.020	0,5 0.020
SD522-39-78-32R7	03080821	39,0 1.535	78,0 3.071	168,0 6.614	83,0 3.268	108,0 4.252	60,0 2.362	32,0 1.260	42,0 1.654	SPGX12T3	SCGX11T308	0,39 0.015	0,5 0.020
SD522-39-78-40R7	03080822	39,0 1.535	78,0 3.071	176,0 6.929	83,0 3.268	108,0 4.252	68,0 2.677	40,0 1.575	50,0 1.969	SPGX12T3	SCGX11T308	0,39 0.015	0,5 0.020
SD522-40-80-32R7	03080823	40,0 1.575	80,0 3.150	170,0 6.693	85,0 3.346	110,0 4.331	60,0 2.362	32,0 1.260	50,0 1.969	SPGX12T3	SCGX11T308	0,19 0.007	0,5 0.020
SD522-40-80-40R7	03080824	40,0 1.575	80,0 3.150	178,0 7.008	85,0 3.346	110,0 4.331	68,0 2.677	40,0 1.575	50,0 1.969	SPGX12T3	SCGX11T308	0,19 0.007	0,5 0.020
SD522-41-82-40R7	03080826	41,0 1.614	82,0 3.228	180,0 7.087	87,0 3.425	112,0 4.409	68,0 2.677	40,0 1.575	50,0 1.969	SPGX12T3	SCGX120408	0,19 0.007	0,5 0.020
SD522-42-84-40R7	03080828	42,0 1.654	84,0 3.307	182,0 7.165	89,0 3.504	114,0 4.488	68,0 2.677	40,0 1.575	50,0 1.969	SPGX12T3	SCGX120408	0,19 0.007	0,5 0.020
SD522-43-86-40R7	03080830	43,0 1.693	86,0 3.386	184,0 7.244	91,0 3.583	116,0 4.567	68,0 2.677	40,0 1.575	50,0 1.969	SPGX12T3	SCGX120408	0,05 0.002	0,5 0.020

Introduzione

Foratura

Alesatura

Barenatura

Allegato

Codice di ordinazione	Codice prodotto	DC	LU	OAL	LUX	LFS	LS	DMM	DF	Inserto		Regolazione radiale	
		mm Inch	mm Inch	mm Inch	mm Inch	mm Inch	mm Inch	mm Inch	mm Inch	mm Inch	mm - Inch -	mm + Inch +	
SD522-44-88-40R7	03080832	44,0 1.732	88,0 3.465	186,0 7.323	93,0 3.661	118,0 4.646	68,0 2.677	40,0 1.575	50,0 1.969	SPGX1504	SCGX120408	0,5 0.020	0,41 0.016
SD522-45-90-40R7	03080834	45,0 1.772	90,0 3.543	188,0 7.402	95,0 3.740	120,0 4.724	68,0 2.677	40,0 1.575	50,0 1.969	SPGX1504	SCGX150512	0,5 0.020	0,41 0.016
SD522-46-92-40R7	03080835	46,0 1.811	92,0 3.622	190,0 7.480	97,0 3.819	122,0 4.803	68,0 2.677	40,0 1.575	50,0 1.969	SPGX1504	SCGX150512	0,5 0.020	0,5 0.020
SD522-47-94-40R7	03080836	47,0 1.850	94,0 3.701	192,0 7.559	99,0 3.898	124,0 4.882	68,0 2.677	40,0 1.575	50,0 1.969	SPGX1504	SCGX150512	0,5 0.020	0,5 0.020
SD522-48-96-40R7	03080837	48,0 1.890	96,0 3.780	194,0 7.638	101,0 3.976	126,0 4.961	68,0 2.677	40,0 1.575	59,35 2.337	SPGX1504	SCGX150512	0,45 0.018	0,5 0.020
SD522-49-98-40R7	03080838	49,0 1.929	98,0 3.858	196,0 7.717	103,0 4.055	128,0 5.039	68,0 2.677	40,0 1.575	59,35 2.337	SPGX1504	SCGX150512	0,2 0.008	0,5 0.020
SD522-50-100-40R7	03080839	50,0 1.969	100,0 3.937	198,0 7.795	105,0 4.134	130,0 5.118	68,0 2.677	40,0 1.575	59,35 2.337	SPGX1504	SCGX150512	0,2 0.008	0,5 0.020
SD522-51-102-40R7	03080840	51,0 2.008	102,0 4.016	200,0 7.874	107,0 4.213	132,0 5.197	68,0 2.677	40,0 1.575	59,35 2.337	SPGX1504	SCGX150512	0,2 0.008	0,5 0.020
SD522-52-104-40R7	03080841	52,0 2.047	104,0 4.094	202,0 7.953	109,0 4.291	134,0 5.276	68,0 2.677	40,0 1.575	59,35 2.337	SPGX1904	SCGX150512	0,5 0.020	0,42 0.017
SD522-53-106-40R7	03080842	53,0 2.087	106,0 4.173	204,0 8.031	111,0 4.370	136,0 5.354	68,0 2.677	40,0 1.575	59,35 2.337	SPGX1904	SCGX150512	0,5 0.020	0,42 0.017
SD522-54-108-40R7	03080843	54,0 2.126	108,0 4.252	206,0 8.110	113,0 4.449	138,0 5.433	68,0 2.677	40,0 1.575	59,35 2.337	SPGX1904	SCGX150512	0,5 0.020	0,5 0.020
SD522-55-110-40R7	03080844	55,0 2.165	110,0 4.331	208,0 8.189	115,0 4.528	140,0 5.512	68,0 2.677	40,0 1.575	59,35 2.337	SPGX1904	SCGX150512	0,5 0.020	0,5 0.020
SD522-56-112-40R7	03080845	56,0 2.205	112,0 4.409	210,0 8.268	117,0 4.606	142,0 5.591	68,0 2.677	40,0 1.575	59,35 2.337	SPGX1904	SCGX150512	0,5 0.020	0,5 0.020
SD522-57-114-40R7	03080846	57,0 2.244	114,0 4.488	212,0 8.346	119,0 4.685	144,0 5.669	68,0 2.677	40,0 1.575	59,35 2.337	SPGX1904	SCGX150512	0,39 0.015	0,5 0.020
SD522-58-116-40R7	03080847	58,0 2.283	116,0 4.567	214,0 8.425	121,0 4.764	146,0 5.748	68,0 2.677	40,0 1.575	63,0 2.480	SPGX1904	SCGX150512	0,09 0.004	0,5 0.020
SD522-59-118-40R7	03080848	59,0 2.323	118,0 4.646	216,0 8.504	123,0 4.843	148,0 5.827	68,0 2.677	40,0 1.575	63,0 2.480	SPGX1904	SCGX150512	0,09 0.004	0,5 0.020

Parti di ricambio, comprese nella fornitura

Per punta diametro (mm)	Vite di bloccaggio inserto		Chiave per vite inserto
	Inserto centrale	Inserto periferico	
15,00-17,45	C02245-T07P	C02245-T07P	T07P-2
17,46-19,49	C02205-T07P	C02245-T07P	T07P-2
19,50-21,24	C02205-T07P	C02205-T07P	T07P-2
21,25-22,49	C02506-T08P	C02506-T08P	T08P-2
22,50-25,49	C02507-T08P	C03007-T08P	T08P-2
25,50-28,49	C03007-T09P	C03007-T09P	T09P-2
28,50-31,49	C03007-T09P	C03009-T09P	T09P-2
31,50-40,49	C03508-T15P	C03508-T15P	T15P-2D
40,50-43,24	C03508-T15P	C05012-T15P	T15P-2D
43,25-59,00	C04011-T15P	C05012-T15P	T15P-2D



Introduzione

Foratura

Alesatura

Barenatura

Allegato

Accessori

Per punta diametro (mm)	Chiave dinamometrica*	Bit sostituibile	Valore di coppia
			
15,00-17,45	T00-07P09	T00-07P	0,9 Nm
17,46-19,49	T00-07P09	T00-07P	0,9 Nm
19,50-21,24	T00-07P09	T00-07P	0,9 Nm
21,25-22,49	T00-08P12	T00-08P	1,2 Nm
22,50-25,49	T00-08P12	T00-08P	1,2 Nm
25,50-28,49	T00-09P20	T00-09P	2,0 Nm
28,50-31,49	T00-09P20	T00-09P	2,0 Nm
31,50-40,49	T00-15P30	T00-15P	3,0 Nm
40,50-43,24	T00-15P30	T00-15P	3,0 Nm
43,25-59,00	T00-15P30	T00-15P	3,0 Nm

*Lama inclusa.

Introduzione

Foratura

Alesatura

Barenatura

Allegato

SD522

Profondità di foratura ~ 2 x D – Pollici

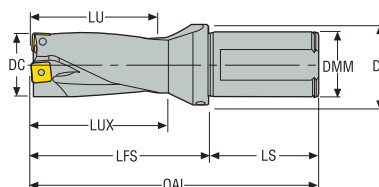



- Codolo ISO 9766, R7
- Adduzione refrigerante interna
- Per le informazioni sugli inserti, vedere pagina(e) 297-303
- Per i parametri di taglio raccomandati, vedere pagina(e) 304, 305
- Per i diametri intermedi, utilizzare MyDesign.

Codice di ordinazione	Codice prodotto	DC	LU	OAL	LUX	LFS	LS	DMM	DF	Inserto		Regolazione radiale	
										Inserto centrale	Inserto periferico	Inch -	Inch +
SD522-0594-119-1000R7	03080704	0.594	1.190	4.621	1.387	2.371	2.250	1.000	1.378	SPGX0502	SCGX050204	0.008	0.013
SD522-0625-125-1000R7	03080705	0.625	1.250	4.681	1.447	2.431	2.250	1.000	1.378	SPGX0502	SCGX050204	0.005	0.015
SD522-0656-131-1000R7	03080707	0.656	1.310	4.741	1.507	2.491	2.250	1.000	1.378	SPGX0502	SCGX050204	0.002	0.019
SD522-0687-137-1000R7	03080709	0.687	1.370	4.801	1.567	2.551	2.250	1.000	1.378	SPGX0502	SCGX050204	0	0.020
SD522-0709-142-1000R7	03080710	0.709	1.420	4.851	1.617	2.601	2.250	1.000	1.378	SPGX0602	SCGX050204	0.013	0.008
SD522-0750-150-1000R7	03080712	0.750	1.500	4.931	1.697	2.681	2.250	1.000	1.378	SPGX0602	SCGX050204	0.004	0.017
SD522-0766-153-1000R7	03080713	0.766	1.530	4.961	1.727	2.711	2.250	1.000	1.378	SPGX0602	SCGX050204	0.001	0.020
SD522-0787-157-1000R7	03080714	0.787	1.570	5.001	1.767	2.751	2.250	1.000	1.378	SPGX0602	SCGX060204	0.003	0.018
SD522-0812-162-1000R7	03080715	0.812	1.620	5.051	1.817	2.801	2.250	1.000	1.378	SPGX0602	SCGX060204	0.001	0.020
SD522-0827-165-1000R7	03080717	0.827	1.650	5.081	1.847	2.831	2.250	1.000	1.378	SPGX0602	SCGX060204	0	0.020
SD522-0875-175-1000R7	03080718	0.875	1.750	5.181	1.947	2.931	2.250	1.000	1.378	SPGX0703	SCGX060204	0.015	0.020
SD522-0906-181-1000R7	03080720	0.906	1.810	5.241	2.007	2.991	2.250	1.000	1.378	SPGX0703	SCGX070308	0.013	0.020
SD522-0922-184-1000R7	03080721	0.922	1.840	5.271	2.037	3.021	2.250	1.000	1.378	SPGX0703	SCGX070308	0.010	0.020
SD522-0937-187-1000R7	03080722	0.937	1.870	5.301	2.067	3.051	2.250	1.000	1.378	SPGX0703	SCGX070308	0.004	0.020
SD522-0984-197-1250R7	03080724	0.984	1.970	5.526	2.167	3.151	2.375	1.250	1.654	SPGX0703	SCGX070308	0.004	0.020
SD522-1000-200-1250R7	03080725	1.000	2.000	5.556	2.197	3.181	2.375	1.250	1.654	SPGX0703	SCGX070308	0.004	0.020
SD522-1032-206-1250R7	03080727	1.032	2.060	5.616	2.257	3.241	2.375	1.250	1.654	SPGX0903	SCGX070308	0.020	0.004
SD522-1062-212-1250R7	03080728	1.062	2.120	5.676	2.317	3.301	2.375	1.250	1.654	SPGX0903	SCGX070308	0.020	0.010
SD522-1125-225-1250R7	03080730	1.125	2.250	5.806	2.447	3.431	2.375	1.250	1.654	SPGX0903	SCGX09T308	0.008	0.020
SD522-1187-237-1250R7	03080732	1.187	2.370	5.926	2.567	3.551	2.375	1.250	1.654	SPGX0903	SCGX09T308	0.005	0.020
SD522-1250-250-1500R7	03080735	1.250	2.500	6.306	2.697	3.681	2.625	1.500	1.969	SPGX11T3	SCGX09T308	0.020	0.011
SD522-1312-262-1500R7	03080736	1.312	2.620	6.426	2.817	3.801	2.625	1.500	1.969	SPGX11T3	SCGX09T308	0.020	0.020
SD522-1375-275-1500R7	03080737	1.375	2.750	6.556	2.947	3.931	2.625	1.500	1.969	SPGX11T3	SCGX11T308	0.009	0.020
SD522-1437-287-1500R7	03080739	1.437	2.870	6.676	3.067	4.051	2.625	1.500	1.969	SPGX11T3	SCGX11T308	0.004	0.020
SD522-1500-300-1500R7	03080743	1.500	3.000	6.806	3.197	4.181	2.625	1.500	1.969	SPGX12T3	SCGX11T308	0.020	0.020
SD522-1625-325-1500R7	03080748	1.625	3.250	7.056	3.447	4.431	2.625	1.500	1.969	SPGX12T3	SCGX120408	0.007	0.020
SD522-1750-350-1500R7	03080756	1.750	3.500	7.306	3.697	4.681	2.625	1.500	1.969	SPGX1504	SCGX120408	0.020	0.016
SD522-1875-375-1500R7	03080763	1.875	3.750	7.556	3.947	4.931	2.625	1.500	1.969	SPGX1504	SCGX150512	0.020	0.020
SD522-2000-400-1500R7	03080769	2.000	4.000	7.806	4.197	5.181	2.625	1.500	2.337	SPGX1504	SCGX150512	0.008	0.020
SD522-2125-425-1500R7	03080773	2.125	4.250	8.056	4.447	5.431	2.625	1.500	2.337	SPGX1904	SCGX150512	0.020	0.020
SD522-2250-450-1500R7	03080779	2.250	4.500	8.306	4.697	5.681	2.625	1.500	2.337	SPGX1904	SCGX150512	0.013	0.020
SD522-2375-475-1500R7	03080783	2.375	4.750	8.556	4.947	5.931	2.625	1.500	2.480	SPGX1904	SCGX150512	0.004	0.020

Parti di ricambio, comprese nella fornitura

Per punta diametro (pollici)	Vite di bloccaggio inserto		Chiave per vite inserto
			
	Inserto centrale	Inserto periferico	
0.594-0.687	C02245-T07P	C02245-T07P	T07P-2
0.709-0.766	C02205-T07P	C02245-T07P	T07P-2
0.787	C02205-T07P	C02205-T07P	T07P-2
0.812-0.827	C02205-T07P	C02205-T07P	T07P-2
0.875	C02506-T08P	C02506-T08P	T08P-2
0.906-1.000	C02507-T08P	C03007-T08P	T08P-2
1.032-1.062	C03007-T09P	C03007-T09P	T09P-2
1.125-1.187	C03007-T09P	C03009-T09P	T09P-2
1.250-1.500	C03508-T15P	C03508-T15P	T15P-2D
1.625	C03508-T15P	C05012-T15P	T15P-2D
1.750-2.375	C04011-T15P	C05012-T15P	T15P-2D

Accessori

Per punta diametro (pollici)	Chiave dinamometrica*	Bit sostituibile	Valore di coppia
			
0.594-0.687	T00-07P09	T00-07P	8 in/lbs
0.709-0.766	T00-07P09	T00-07P	8 in/lbs
0.787	T00-07P09	T00-07P	8 in/lbs
0.812-0.827	T00-07P09	T00-07P	8 in/lbs
0.875	T00-08P12	T00-08P	10.6 in/lbs
0.906-1.000	T00-08P12	T00-08P	10.6 in/lbs
1.032-1.062	T00-09P20	T00-09P	17.7 in/lbs
1.125-1.187	T00-09P20	T00-09P	17.7 in/lbs
1.250-1.500	T00-15P30	T00-15P	26.6 in/lbs
1.625	T00-15P30	T00-15P	26.6 in/lbs
1.750-2.375	T00-15P30	T00-15P	26.6 in/lbs

*Lama inclusa.

SD522

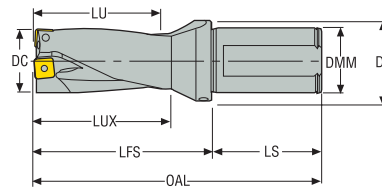

Profondità di foratura ~ 2 x D – Pollici





- Codolo ISO 9766, R7-C
- Adduzione refrigerante interna
- Per le informazioni sugli inserti, vedere pagina(e) 297-303
- Per i parametri di taglio raccomandati, vedere pagina(e) 304-305
- Per i diametri intermedi, utilizzare MyDesign.
- Per applicazioni statiche

Codice di ordinazione	Codice prodotto	DC	LU	OAL	LUX	LFS	LS	DMM	DF	Inserto		Regolazione radiale	
										Inserto centrale	Inserto periferico	Inch -	Inch +
SD522-0625-125-1000R7-C	03080706	0.625	1.250	5.378	1.447	2.628	2.750	1.000	1.378	SPGX0502	SCGX050204	0.005	0.015
SD522-0687-137-1000R7-C	03080708	0.687	1.370	5.498	1.567	2.748	2.750	1.000	1.378	SPGX0502	SCGX050204	0	0.020
SD522-0750-150-1000R7-C	03080711	0.750	1.500	5.628	1.697	2.878	2.750	1.000	1.378	SPGX0602	SCGX050204	0.004	0.017
SD522-0812-162-1000R7-C	03080716	0.812	1.620	5.748	1.817	2.998	2.750	1.000	1.378	SPGX0602	SCGX060204	0.001	0.020
SD522-0875-175-1000R7-C	03080719	0.875	1.750	5.878	1.947	3.128	2.750	1.000	1.378	SPGX0703	SCGX060204	0.015	0.020
SD522-0937-187-1000R7-C	03080723	0.937	1.870	5.998	2.067	3.248	2.750	1.000	1.378	SPGX0703	SCGX070308	0.004	0.020
SD522-1000-200-1250R7-C	03080726	1.000	2.000	6.128	2.197	3.378	2.750	1.250	1.654	SPGX0703	SCGX070308	0.004	0.020
SD522-1062-212-1250R7-C	03080729	1.062	2.120	6.248	2.317	3.498	2.750	1.250	1.654	SPGX0903	SCGX070308	0.020	0.010
SD522-1125-225-1250R7-C	03080731	1.125	2.250	6.378	2.447	3.628	2.750	1.250	1.654	SPGX0903	SCGX09T308	0.008	0.020
SD522-1187-237-1250R7-C	03080733	1.187	2.370	6.498	2.567	3.748	2.750	1.250	1.654	SPGX0903	SCGX09T308	0.005	0.020
SD522-1250-250-1500R7-C	03080734	1.250	2.500	6.628	2.697	3.878	2.750	1.500	1.969	SPGX11T3	SCGX09T308	0.020	0.011
SD522-1375-275-1500R7-C	03080738	1.375	2.750	6.878	2.947	4.128	2.750	1.500	1.969	SPGX11T3	SCGX11T308	0.009	0.020
SD522-1500-300-1500R7-C	03080742	1.500	3.000	7.128	3.197	4.378	2.750	1.500	1.969	SPGX12T3	SCGX11T308	0.020	0.020
SD522-1750-350-1500R7-C	03080757	1.750	3.500	7.628	3.697	4.878	2.750	1.500	1.969	SPGX1504	SCGX120408	0.020	0.016
SD522-2000-400-1500R7-C	03080770	2.000	4.000	8.128	4.197	5.378	2.750	1.500	2.337	SPGX1504	SCGX150512	0.008	0.020
SD522-2125-425-1500R7-C	03080774	2.125	4.250	8.378	4.447	5.628	2.750	1.500	2.337	SPGX1904	SCGX150512	0.020	0.020
SD522-2250-450-1500R7-C	03080780	2.250	4.500	8.628	4.697	5.878	2.750	1.500	2.337	SPGX1904	SCGX150512	0.013	0.020
SD522-2375-475-1500R7-C	03080784	2.375	4.750	8.878	4.947	6.128	2.750	1.500	2.480	SPGX1904	SCGX150512	0.004	0.020

Parti di ricambio, comprese nella fornitura

Per punta diametro (pollici)	Vite di bloccaggio inserto centrale	Vite di bloccaggio inserto periferico	Chiave	Grano
0.625	 C02245-T07P	 C02245-T07P	 T07P-2	 R1/4
0.687	C02245-T07P	C02245-T07P	T07P-2	R1/4
0.750	C02205-T07P	C02245-T07P	T07P-2	R1/4
0.812	C02205-T07P	C02205-T07P	T07P-2	R1/4
0.875	C02506-T08P	C02506-T08P	T08P-2	R1/4
0.937-1.000	C02507-T08P	C03007-T08P	T08P-2	R1/4
1.062	C03007-T09P	C03007-T09P	T09P-2	R1/4
1.125-1.187	C03007-T09P	C03009-T09P	T09P-2	R1/4
1.250-1.500	C03508-T15P	C03508-T15P	T15P-2D	R1/4
1.750-2.375	C04011-T15P	C05012-T15P	T15P-2D	R1/4

Accessori

Per punta diametro (pollici)	Adattatore	Chiave dinamometrica
		
0.625	1310	T00-07P09
0.687	1310	T00-07P09
0.750	1310	T00-07P09
0.812	1310	T00-07P09
0.875	1310	T00-08P12
0.937-1.000	1310	T00-08P12
1.062	1310	T00-09P20
1.125-1.187	1310	T00-09P20
1.250-1.500	1310	T00-15P30
1.750-2.375	1310	T00-15P35

Introduzione

Foratura

Alesatura

Barenatura

Allegato

SD522

Profondità di foratura ~ 2 x D – Misure metriche/Pollici

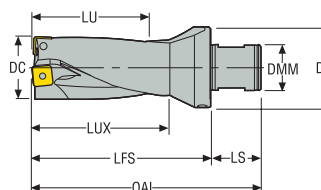

- Attacco compatibile ABS 50, R2
- Adduzione refrigerante interna
- Per le informazioni sugli inserti, vedere pagina(e) 297-303
- Per i parametri di taglio raccomandati, vedere pagina(e) 304, 305
- Per i diametri intermedi, utilizzare MyDesign.

Codice di ordinazione	Codice prodotto	DC	LU	OAL	LUX	LFS	LS	DMM	DF	Inserto		Regolazione radiale	
										Inserto centrale	Inserto periferico	mm - Inch -	mm + Inch +
SD522-15-30-50R2	03081056	15,0 0.591	30,0 1.181	91,0 3.583	35,0 1.378	60,0 2.362	31,0 1.220	28,0 1.102	50,0 1.969	SPGX0502	SCGX050204	0,22 0.009	0,31 0.012
SD522-15.5-31-50R2	03081057	15,5 0.610	31,0 1.220	92,0 3.622	36,0 1.417	61,0 2.402	31,0 1.220	28,0 1.102	50,0 1.969	SPGX0502	SCGX050204	0,17 0.007	0,36 0.014
SD522-16-32-50R2	03080751	16,0 0.630	32,0 1.260	93,0 3.661	37,0 1.457	62,0 2.441	31,0 1.220	28,0 1.102	50,0 1.969	SPGX0502	SCGX050204	0,12 0.005	0,41 0.016
SD522-16.5-33-50R2	03081058	16,5 0.650	33,0 1.299	94,0 3.701	38,0 1.496	63,0 2.480	31,0 1.220	28,0 1.102	50,0 1.969	SPGX0502	SCGX050204	0,07 0.003	0,46 0.018
SD522-17-34-50R2	03081059	17,0 0.669	34,0 1.339	95,0 3.740	39,0 1.535	64,0 2.520	31,0 1.220	28,0 1.102	50,0 1.969	SPGX0502	SCGX050204	0,02 0.001	0,5 0.020
SD522-17.5-35-50R2	03081060	17,5 0.689	35,0 1.378	96,0 3.780	40,0 1.575	65,0 2.559	31,0 1.220	28,0 1.102	50,0 1.969	SPGX0602	SCGX050204	0,43 0.017	0,1 0.004
SD522-18-36-50R2	03080762	18,0 0.709	36,0 1.417	97,0 3.819	41,0 1.614	66,0 2.598	31,0 1.220	28,0 1.102	50,0 1.969	SPGX0602	SCGX050204	0,32 0.013	0,21 0.008
SD522-18.5-37-50R2	03081061	18,5 0.728	37,0 1.457	98,0 3.858	42,0 1.654	67,0 2.638	31,0 1.220	28,0 1.102	50,0 1.969	SPGX0602	SCGX050204	0,22 0.009	0,31 0.012
SD522-19-38-50R2	03080767	19,0 0.748	38,0 1.496	99,0 3.898	43,0 1.693	68,0 2.677	31,0 1.220	28,0 1.102	50,0 1.969	SPGX0602	SCGX050204	0,11 0.004	0,42 0.017
SD522-20-40-50R2	03080772	20,0 0.787	40,0 1.575	101,0 3.976	45,0 1.772	70,0 2.756	31,0 1.220	28,0 1.102	50,0 1.969	SPGX0602	SCGX060204	0,07 0.003	0,46 0.018
SD522-20.62-42-50R2	03080768	20,62 0.812	42,0 1.654	103,0 4.055	47,0 1.850	72,0 2.835	31,0 1.220	28,0 1.102	50,0 1.969	SPGX0602	SCGX060204	0,03 0.001	0,5 0.020
SD522-21-42-50R2	03081062	21,0 0.827	42,0 1.654	103,0 4.055	47,0 1.850	72,0 2.835	31,0 1.220	28,0 1.102	50,0 1.969	SPGX0602	SCGX060204	0,01 0	0,5 0.020
SD522-22-44-50R2	03080778	22,0 0.866	44,0 1.732	105,0 4.134	49,0 1.929	74,0 2.913	31,0 1.220	28,0 1.102	50,0 1.969	SPGX0703	SCGX060204	0,44 0.017	0,46 0.018
SD522-22.23-45-50R2	03080776	22,23 0.875	45,0 1.772	106,0 4.173	50,0 1.969	75,0 2.953	31,0 1.220	28,0 1.102	50,0 1.969	SPGX0703	SCGX060204	0,39 0.015	0,5 0.020
SD522-23-46-50R2	03080782	23,0 0.906	46,0 1.811	107,0 4.213	51,0 2.008	76,0 2.992	31,0 1.220	28,0 1.102	50,0 1.969	SPGX0703	SCGX070308	0,33 0.013	0,5 0.020
SD522-24-48-50R2	03080786	24,0 0.945	48,0 1.890	109,0 4.291	53,0 2.087	78,0 3.071	31,0 1.220	28,0 1.102	50,0 1.969	SPGX0703	SCGX070308	0,11 0.004	0,5 0.020
SD522-25-50-50R2	03080789	25,0 0.984	50,0 1.969	111,0 4.370	55,0 2.165	80,0 3.150	31,0 1.220	28,0 1.102	50,0 1.969	SPGX0703	SCGX070308	0,11 0.004	0,5 0.020
SD522-25.40-51-50R2	03080787	25,4 1.000	51,0 2.008	112,0 4.409	56,0 2.205	81,0 3.189	31,0 1.220	28,0 1.102	50,0 1.969	SPGX0703	SCGX070308	0,11 0.004	0,5 0.020
SD522-26-52-50R2	03080791	26,0 1.024	52,0 2.047	113,0 4.449	57,0 2.244	82,0 3.228	31,0 1.220	28,0 1.102	50,0 1.969	SPGX0903	SCGX070308	0,5 0.020	0,11 0.004
SD522-27-54-50R2	03080793	27,0 1.063	54,0 2.126	115,0 4.528	59,0 2.323	84,0 3.307	31,0 1.220	28,0 1.102	50,0 1.969	SPGX0903	SCGX070308	0,5 0.020	0,26 0.010
SD522-28-56-50R2	03081087	28,0 1.102	56,0 2.205	117,0 4.606	61,0 2.402	86,0 3.386	31,0 1.220	28,0 1.102	50,0 1.969	SPGX0903	SCGX070308	0,28 0.011	0,5 0.020
SD522-28.59-58-50R2	03080794	28,59 1.126	58,0 2.283	119,0 4.685	63,0 2.480	88,0 3.465	31,0 1.220	28,0 1.102	50,0 1.969	SPGX0903	SCGX09T308	0,21 0.008	0,5 0.020

Introduzione

Foratura

Alesatura

Barenatura

Allegato

Codice di ordinazione	Codice prodotto	DC	LU	OAL	LUX	LFS	LS	DMM	DF	Inserto		Regolazione radiale	
		mm Inch	mm Inch	mm Inch	mm Inch	mm Inch	mm Inch	mm Inch	mm Inch	mm Inch	mm - Inch -	mm + Inch +	
SD522-29-58-50R2	03080797	29,0 1.142	58,0 2.283	119,0 4.685	63,0 2.480	88,0 3.465	31,0 1.220	28,0 1.102	50,0 1.969	SPGX0903	SCGX09T308	0,18 0.007	0,5 0.020
SD522-30-60-50R2	03080799	30,0 1.181	60,0 2.362	121,0 4.764	65,0 2.559	90,0 3.543	31,0 1.220	28,0 1.102	50,0 1.969	SPGX0903	SCGX09T308	0,12 0.005	0,5 0.020
SD522-31-62-50R2	03081063	31,0 1.220	62,0 2.441	123,0 4.843	67,0 2.638	92,0 3.622	31,0 1.220	28,0 1.102	50,0 1.969	SPGX0903	SCGX09T308	0,12 0.005	0,5 0.020
SD522-31.75-64-50R2	03080800	31,75 1.250	64,0 2.520	125,0 4.921	69,0 2.717	94,0 3.701	31,0 1.220	28,0 1.102	50,0 1.969	SPGX11T3	SCGX09T308	0,5 0.020	0,28 0.011
SD522-32-64-50R2	03080804	32,0 1.260	64,0 2.520	125,0 4.921	69,0 2.717	94,0 3.701	31,0 1.220	28,0 1.102	50,0 1.969	SPGX11T3	SCGX09T308	0,5 0.020	0,31 0.012
SD522-33-66-50R2	03080807	33,0 1.299	66,0 2.598	127,0 5.000	71,0 2.795	96,0 3.780	31,0 1.220	28,0 1.102	50,0 1.969	SPGX11T3	SCGX09T308	0,5 0.020	0,46 0.018
SD522-34-68-50R2	03081064	34,0 1.339	68,0 2.677	129,0 5.079	73,0 2.874	98,0 3.858	31,0 1.220	28,0 1.102	50,0 1.969	SPGX11T3	SCGX09T308	0,22 0.009	0,5 0.020
SD522-35-70-50R2	03080812	35,0 1.378	70,0 2.756	131,0 5.157	75,0 2.953	100,0 3.937	31,0 1.220	28,0 1.102	50,0 1.969	SPGX11T3	SCGX11T308	0,22 0.009	0,5 0.020
SD522-36-72-50R2	03080815	36,0 1.417	72,0 2.835	133,0 5.236	77,0 3.031	102,0 4.016	31,0 1.220	28,0 1.102	50,0 1.969	SPGX11T3	SCGX11T308	0,09 0.004	0,5 0.020
SD522-37-74-50R2	03081065	37,0 1.457	74,0 2.913	135,0 5.315	79,0 3.110	104,0 4.094	31,0 1.220	28,0 1.102	50,0 1.969	SPGX11T3	SCGX11T308	0,09 0.004	0,5 0.020
SD522-38-76-50R2	03080820	38,0 1.496	76,0 2.992	137,0 5.394	81,0 3.189	106,0 4.173	31,0 1.220	28,0 1.102	50,0 1.969	SPGX12T3	SCGX11T308	0,5 0.020	0,5 0.020
SD522-39-78-50R2	03081066	39,0 1.535	78,0 3.071	139,0 5.472	83,0 3.268	108,0 4.252	31,0 1.220	28,0 1.102	50,0 1.969	SPGX12T3	SCGX11T308	0,39 0.015	0,5 0.020
SD522-40-80-50R2	03080825	40,0 1.575	80,0 3.150	141,0 5.551	85,0 3.346	110,0 4.331	31,0 1.220	28,0 1.102	50,0 1.969	SPGX12T3	SCGX11T308	0,19 0.007	0,5 0.020
SD522-41-82-50R2	03080827	41,0 1.614	82,0 3.228	143,0 5.630	87,0 3.425	112,0 4.409	31,0 1.220	28,0 1.102	50,0 1.969	SPGX12T3	SCGX120408	0,19 0.007	0,5 0.020
SD522-42-84-50R2	03080829	42,0 1.654	84,0 3.307	145,0 5.709	89,0 3.504	114,0 4.488	31,0 1.220	28,0 1.102	50,0 1.969	SPGX12T3	SCGX120408	0,19 0.007	0,5 0.020
SD522-43-86-50R2	03081067	43,0 1.693	86,0 3.386	147,0 5.787	91,0 3.583	116,0 4.567	31,0 1.220	28,0 1.102	50,0 1.969	SPGX12T3	SCGX120408	0,05 0.002	0,5 0.020
SD522-44.45-89-50R2	03080831	44,45 1.750	89,0 3.504	150,0 5.906	94,0 3.701	119,0 4.685	31,0 1.220	28,0 1.102	50,0 1.969	SPGX1504	SCGX120408	0,5 0.020	0,41 0.016

Parti di ricambio, comprese nella fornitura

Per punta diametro (mm)	Vite di bloccaggio inserto		Chiave per vite inserto
	Inserto centrale	Inserto periferico	
15,00-17,45	C02245-T07P	C02245-T07P	T07P-2
17,46-19,49	C02205-T07P	C02245-T07P	T07P-2
19,50-21,24	C02205-T07P	C02205-T07P	T07P-2
21,25-22,49	C02506-T08P	C02506-T08P	T08P-2
22,50-25,49	C02507-T08P	C03007-T08P	T08P-2
25,50-28,49	C03007-T09P	C03007-T09P	T09P-2
28,50-31,49	C03007-T09P	C03009-T09P	T09P-2
31,50-40,49	C03508-T15P	C03508-T15P	T15P-2D
40,50-43,24	C03508-T15P	C05012-T15P	T15P-2D
43,25-59,00	C04011-T15P	C05012-T15P	T15P-2D



Introduzione



Foratura

Alesatura

Barenatura

Allegato

Accessori

Per punta diametro (mm)	Chiave dinamometrica*	Bit sostituibile	Valore di coppia
			
15,00-17,45	T00-07P09	T00-07P	0,9 Nm
17,46-19,49	T00-07P09	T00-07P	0,9 Nm
19,50-21,24	T00-07P09	T00-07P	0,9 Nm
21,25-22,49	T00-08P12	T00-08P	1,2 Nm
22,50-25,49	T00-08P12	T00-08P	1,2 Nm
25,50-28,49	T00-09P20	T00-09P	2,0 Nm
28,50-31,49	T00-09P20	T00-09P	2,0 Nm
31,50-40,49	T00-15P30	T00-15P	3,0 Nm
40,50-43,24	T00-15P30	T00-15P	3,0 Nm
43,25-59,00	T00-15P30	T00-15P	3,0 Nm

*Lama inclusa.

Introduzione

Foratura

Alesatura

Barenatura

Allegato

SD523

Profondità di foratura ~ 3 x D – Misure metriche/Pollici

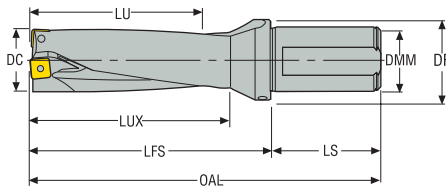

- Codolo ISO 9766, -7
- Adduzione refrigerante interna
- Per le informazioni sugli inserti, vedere pagina(e) 297-303
- Per i parametri di taglio raccomandati, vedere pagina(e) 306-307
- Per i diametri intermedi, utilizzare MyDesign.

Codice di ordinazione	Codice prodotto	DC	LU	OAL	LUX	LFS	LS	DMM	DF	Inserto		Regolazione radiale	
		mm Inch	mm Inch	mm Inch	mm Inch	mm Inch	mm Inch	mm Inch	mm Inch	Inserto centrale	Inserto periferico	mm - Inch -	mm + Inch +
SD523-15-45-20R7	03080548	15,0 0.591	45,0 1.772	125,0 4.921	50,0 1.969	75,0 2.953	50,0 1.969	20,0 0.787	30,0 1.181	SPGX0502	SCGX050204	0,22 0.009	0,31 0.012
SD523-15-45-25R7	03080549	15,0 0.591	45,0 1.772	131,0 5.157	50,0 1.969	75,0 2.953	56,0 2.205	25,0 0.984	35,0 1.378	SPGX0502	SCGX050204	0,22 0.009	0,31 0.012
SD523-15.5-47-20R7	03080544	15,5 0.610	47,0 1.850	127,0 5.000	52,0 2.047	77,0 3.031	50,0 1.969	20,0 0.787	30,0 1.181	SPGX0502	SCGX050204	0,17 0.007	0,36 0.014
SD523-15.5-47-25R7	03080545	15,5 0.610	47,0 1.850	133,0 5.236	52,0 2.047	77,0 3.031	56,0 2.205	25,0 0.984	35,0 1.378	SPGX0502	SCGX050204	0,17 0.007	0,36 0.014
SD523-16-48-20R7	03080557	16,0 0.630	48,0 1.890	128,0 5.039	53,0 2.087	78,0 3.071	50,0 1.969	20,0 0.787	30,0 1.181	SPGX0502	SCGX050204	0,12 0.005	0,41 0.016
SD523-16-48-25R7	03080558	16,0 0.630	48,0 1.890	134,0 5.276	53,0 2.087	78,0 3.071	56,0 2.205	25,0 0.984	35,0 1.378	SPGX0502	SCGX050204	0,12 0.005	0,41 0.016
SD523-16.5-50-20R7	03080552	16,5 0.650	50,0 1.969	130,0 5.118	55,0 2.165	80,0 3.150	50,0 1.969	20,0 0.787	30,0 1.181	SPGX0502	SCGX050204	0,07 0.003	0,46 0.018
SD523-16.5-50-25R7	03080554	16,5 0.650	50,0 1.969	136,0 5.354	55,0 2.165	80,0 3.150	56,0 2.205	25,0 0.984	35,0 1.378	SPGX0502	SCGX050204	0,07 0.003	0,46 0.018
SD523-17-51-20R7	03080568	17,0 0.669	51,0 2.008	131,0 5.157	56,0 2.205	81,0 3.189	50,0 1.969	20,0 0.787	30,0 1.181	SPGX0502	SCGX050204	0,02 0.001	0,5 0.020
SD523-17-51-25R7	03080569	17,0 0.669	51,0 2.008	137,0 5.394	56,0 2.205	81,0 3.189	56,0 2.205	25,0 0.984	35,0 1.378	SPGX0502	SCGX050204	0,02 0.001	0,5 0.020
SD523-17.5-53-20R7	03080562	17,5 0.689	53,0 2.087	133,0 5.236	58,0 2.283	83,0 3.268	50,0 1.969	20,0 0.787	30,0 1.181	SPGX0602	SCGX050204	0,43 0.017	0,1 0.004
SD523-17.5-53-25R7	03080563	17,5 0.689	53,0 2.087	139,0 5.472	58,0 2.283	83,0 3.268	56,0 2.205	25,0 0.984	35,0 1.378	SPGX0602	SCGX050204	0,43 0.017	0,1 0.004
SD523-18-54-20R7	03080574	18,0 0.709	54,0 2.126	134,0 5.276	59,0 2.323	84,0 3.307	50,0 1.969	20,0 0.787	30,0 1.181	SPGX0602	SCGX050204	0,32 0.013	0,21 0.008
SD523-18-54-25R7	03080575	18,0 0.709	54,0 2.126	140,0 5.512	59,0 2.323	84,0 3.307	56,0 2.205	25,0 0.984	35,0 1.378	SPGX0602	SCGX050204	0,32 0.013	0,21 0.008
SD523-18.5-56-20R7	03080570	18,5 0.728	56,0 2.205	136,0 5.354	61,0 2.402	86,0 3.386	50,0 1.969	20,0 0.787	30,0 1.181	SPGX0602	SCGX050204	0,22 0.009	0,31 0.012
SD523-18.5-56-25R7	03080571	18,5 0.728	56,0 2.205	142,0 5.591	61,0 2.402	86,0 3.386	56,0 2.205	25,0 0.984	35,0 1.378	SPGX0602	SCGX050204	0,22 0.009	0,31 0.012
SD523-19-57-20R7	03080583	19,0 0.748	57,0 2.244	137,0 5.394	62,0 2.441	87,0 3.425	50,0 1.969	20,0 0.787	30,0 1.181	SPGX0602	SCGX050204	0,11 0.004	0,42 0.017
SD523-19-57-25R7	03080584	19,0 0.748	57,0 2.244	143,0 5.630	62,0 2.441	87,0 3.425	56,0 2.205	25,0 0.984	35,0 1.378	SPGX0602	SCGX050204	0,11 0.004	0,42 0.017
SD523-19.5-59-20R7	03080579	19,5 0.768	59,0 2.323	139,0 5.472	64,0 2.520	89,0 3.504	50,0 1.969	20,0 0.787	30,0 1.181	SPGX0602	SCGX060204	0,11 0.004	0,42 0.017
SD523-19.5-59-25R7	03080580	19,5 0.768	59,0 2.323	145,0 5.709	64,0 2.520	89,0 3.504	56,0 2.205	25,0 0.984	35,0 1.378	SPGX0602	SCGX060204	0,11 0.004	0,42 0.017
SD523-20-60-25R7	03080590	20,0 0.787	60,0 2.362	146,0 5.748	65,0 2.559	90,0 3.543	56,0 2.205	25,0 0.984	35,0 1.378	SPGX0602	SCGX060204	0,07 0.003	0,46 0.018
SD523-20.5-62-25R7	03080586	20,5 0.807	62,0 2.441	148,0 5.827	67,0 2.638	92,0 3.622	56,0 2.205	25,0 0.984	35,0 1.378	SPGX0602	SCGX060204	0,04 0.002	0,49 0.019

Introduzione

Foratura

Alesatura

Barenatura

Allegato

Codice di ordinazione	Codice prodotto	DC	LU	OAL	LUX	LFS	LS	DMM	DF	Inserto		Regolazione radiale	
		mm Inch	mm Inch	mm Inch	mm Inch	mm Inch	mm Inch	mm Inch	mm Inch	mm Inch	mm - Inch -	mm + Inch +	
SD523-21-63-25R7	03080599	21,0 0.827	63,0 2.480	149,0 5.866	68,0 2.677	93,0 3.661	56,0 2.205	25,0 0.984	35,0 1.378	SPGX0602	SCGX060204	0,01 0	0,5 0.020
SD523-21.5-65-25R7	03080595	21,5 0.846	65,0 2.559	151,0 5.945	70,0 2.756	95,0 3.740	56,0 2.205	25,0 0.984	35,0 1.378	SPGX0703	SCGX060204	0,5 0.020	0,36 0.014
SD523-22-66-25R7	03080605	22,0 0.866	66,0 2.598	152,0 5.984	71,0 2.795	96,0 3.780	56,0 2.205	25,0 0.984	35,0 1.378	SPGX0703	SCGX060204	0,44 0.017	0,46 0.018
SD523-22.5-68-25R7	03080602	22,5 0.886	68,0 2.677	154,0 6.063	73,0 2.874	98,0 3.858	56,0 2.205	25,0 0.984	35,0 1.378	SPGX0703	SCGX070308	0,42 0.017	0,47 0.019
SD523-23-69-25R7	03080608	23,0 0.906	69,0 2.717	155,0 6.102	74,0 2.913	99,0 3.898	56,0 2.205	25,0 0.984	35,0 1.378	SPGX0703	SCGX070308	0,33 0.013	0,5 0.020
SD523-23.5-71-25R7	03080607	23,5 0.925	71,0 2.795	157,0 6.181	76,0 2.992	101,0 3.976	56,0 2.205	25,0 0.984	35,0 1.378	SPGX0703	SCGX070308	0,23 0.009	0,5 0.020
SD523-24-72-25R7	03080612	24,0 0.945	72,0 2.835	158,0 6.220	77,0 3.031	102,0 4.016	56,0 2.205	25,0 0.984	35,0 1.378	SPGX0703	SCGX070308	0,11 0.004	0,5 0.020
SD523-24.5-74-25R7	03080611	24,5 0.965	74,0 2.913	160,0 6.299	79,0 3.110	104,0 4.094	56,0 2.205	25,0 0.984	35,0 1.378	SPGX0703	SCGX070308	0,11 0.004	0,5 0.020
SD523-25-75-32R7	03080616	25,0 0.984	75,0 2.953	165,0 6.496	80,0 3.150	105,0 4.134	60,0 2.362	32,0 1.260	42,0 1.654	SPGX0703	SCGX070308	0,11 0.004	0,5 0.020
SD523-25.5-77-32R7	03080615	25,5 1.004	77,0 3.031	167,0 6.575	82,0 3.228	107,0 4.213	60,0 2.362	32,0 1.260	42,0 1.654	SPGX0903	SCGX070308	0,5 0.020	0,11 0.004
SD523-26-78-32R7	03080619	26,0 1.024	78,0 3.071	168,0 6.614	83,0 3.268	108,0 4.252	60,0 2.362	32,0 1.260	42,0 1.654	SPGX0903	SCGX070308	0,5 0.020	0,11 0.004
SD523-26.5-80-32R7	03080618	26,5 1.043	80,0 3.150	170,0 6.693	85,0 3.346	110,0 4.331	60,0 2.362	32,0 1.260	42,0 1.654	SPGX0903	SCGX070308	0,5 0.020	0,19 0.007
SD523-27-81-32R7	03080622	27,0 1.063	81,0 3.189	171,0 6.732	86,0 3.386	111,0 4.370	60,0 2.362	32,0 1.260	42,0 1.654	SPGX0903	SCGX070308	0,5 0.020	0,26 0.010
SD523-27.5-83-32R7	03080621	27,5 1.083	83,0 3.268	173,0 6.811	88,0 3.465	113,0 4.449	60,0 2.362	32,0 1.260	42,0 1.654	SPGX0903	SCGX070308	0,46 0.018	0,44 0.017
SD523-28-84-32R7	03080626	28,0 1.102	84,0 3.307	174,0 6.850	89,0 3.504	114,0 4.488	60,0 2.362	32,0 1.260	42,0 1.654	SPGX0903	SCGX070308	0,28 0.011	0,5 0.020
SD523-28.5-86-32R7	03080624	28,5 1.122	86,0 3.386	176,0 6.929	91,0 3.583	116,0 4.567	60,0 2.362	32,0 1.260	42,0 1.654	SPGX0903	SCGX09T308	0,21 0.008	0,5 0.020
SD523-29-87-32R7	03080629	29,0 1.142	87,0 3.425	177,0 6.969	92,0 3.622	117,0 4.606	60,0 2.362	32,0 1.260	42,0 1.654	SPGX0903	SCGX09T308	0,18 0.007	0,5 0.020
SD523-29.5-89-32R7	03080628	29,5 1.161	89,0 3.504	179,0 7.047	94,0 3.701	119,0 4.685	60,0 2.362	32,0 1.260	42,0 1.654	SPGX0903	SCGX09T308	0,15 0.006	0,5 0.020
SD523-30-90-32R7	03080632	30,0 1.181	90,0 3.543	180,0 7.087	95,0 3.740	120,0 4.724	60,0 2.362	32,0 1.260	42,0 1.654	SPGX0903	SCGX09T308	0,12 0.005	0,5 0.020
SD523-30.5-92-32R7	03080631	30,5 1.201	92,0 3.622	182,0 7.165	97,0 3.819	122,0 4.803	60,0 2.362	32,0 1.260	42,0 1.654	SPGX0903	SCGX09T308	0,12 0.005	0,5 0.020
SD523-31-93-32R7	03080636	31,0 1.220	93,0 3.661	183,0 7.205	98,0 3.858	123,0 4.843	60,0 2.362	32,0 1.260	42,0 1.654	SPGX0903	SCGX09T308	0,12 0.005	0,5 0.020
SD523-31.5-95-32R7	03080634	31,5 1.240	95,0 3.740	185,0 7.283	100,0 3.937	125,0 4.921	60,0 2.362	32,0 1.260	42,0 1.654	SPGX11T3	SCGX09T308	0,5 0.020	0,24 0.009
SD523-32-96-32R7	03080638	32,0 1.260	96,0 3.780	186,0 7.323	101,0 3.976	126,0 4.961	60,0 2.362	32,0 1.260	42,0 1.654	SPGX11T3	SCGX09T308	0,5 0.020	0,31 0.012
SD523-32-96-40R7	03080639	32,0 1.260	96,0 3.780	194,0 7.638	101,0 3.976	126,0 4.961	68,0 2.677	40,0 1.575	50,0 1.969	SPGX11T3	SCGX09T308	0,5 0.020	0,31 0.012
SD523-33-99-32R7	03080641	33,0 1.299	99,0 3.898	189,0 7.441	104,0 4.094	129,0 5.079	60,0 2.362	32,0 1.260	42,0 1.654	SPGX11T3	SCGX09T308	0,5 0.020	0,46 0.018
SD523-33-99-40R7	03080642	33,0 1.299	99,0 3.898	197,0 7.756	104,0 4.094	129,0 5.079	68,0 2.677	40,0 1.575	50,0 1.969	SPGX11T3	SCGX09T308	0,5 0.020	0,46 0.018
SD523-34-102-32R7	03080644	34,0 1.339	102,0 4.016	192,0 7.559	107,0 4.213	132,0 5.197	60,0 2.362	32,0 1.260	42,0 1.654	SPGX11T3	SCGX09T308	0,22 0.009	0,5 0.020
SD523-34-102-40R7	03080645	34,0 1.339	102,0 4.016	200,0 7.874	107,0 4.213	132,0 5.197	68,0 2.677	40,0 1.575	50,0 1.969	SPGX11T3	SCGX09T308	0,22 0.009	0,5 0.020
SD523-35-105-32R7	03080648	35,0 1.378	105,0 4.134	195,0 7.677	110,0 4.331	135,0 5.315	60,0 2.362	32,0 1.260	42,0 1.654	SPGX11T3	SCGX11T308	0,22 0.009	0,5 0.020
SD523-35-105-40R7	03080649	35,0 1.378	105,0 4.134	203,0 7.992	110,0 4.331	135,0 5.315	68,0 2.677	40,0 1.575	50,0 1.969	SPGX11T3	SCGX11T308	0,22 0.009	0,5 0.020
SD523-35.5-107-40R7	03080647	35,5 1.398	107,0 4.213	205,0 8.071	112,0 4.409	137,0 5.394	68,0 2.677	40,0 1.575	50,0 1.969	SPGX11T3	SCGX11T308	0,09 0.004	0,5 0.020

Codice di ordinazione	Codice prodotto	DC	LU	OAL	LUX	LFS	LS	DMM	DF	Inserito		Regolazione radiale	
		mm <i>Inch</i>	mm <i>Inch</i>	mm <i>Inch</i>	mm <i>Inch</i>	mm <i>Inch</i>	mm <i>Inch</i>	mm <i>Inch</i>	mm <i>Inch</i>	mm <i>Inch</i>	Inserito centrale	Inserito periferico	mm - <i>Inch -</i>
SD523-36-108-32R7	03080651	36,0 1.417	108,0 4.252	198,0 7.795	113,0 4.449	138,0 5.433	60,0 2.362	32,0 1.260	42,0 1.654	SPGX11T3	SCGX11T308	0,09 0.004	0,5 0.020
SD523-36-108-40R7	03080652	36,0 1.417	108,0 4.252	206,0 8.110	113,0 4.449	138,0 5.433	68,0 2.677	40,0 1.575	50,0 1.969	SPGX11T3	SCGX11T308	0,09 0.004	0,5 0.020
SD523-37-111-32R7	03080653	37,0 1.457	111,0 4.370	201,0 7.913	116,0 4.567	141,0 5.551	60,0 2.362	32,0 1.260	42,0 1.654	SPGX11T3	SCGX11T308	0,09 0.004	0,5 0.020
SD523-37-111-40R7	03080654	37,0 1.457	111,0 4.370	209,0 8.228	116,0 4.567	141,0 5.551	68,0 2.677	40,0 1.575	50,0 1.969	SPGX11T3	SCGX11T308	0,09 0.004	0,5 0.020
SD523-38-114-32R7	03080655	38,0 1.496	114,0 4.488	204,0 8.031	119,0 4.685	144,0 5.669	60,0 2.362	32,0 1.260	42,0 1.654	SPGX12T3	SCGX11T308	0,5 0.020	0,5 0.020
SD523-38-114-40R7	03080656	38,0 1.496	114,0 4.488	212,0 8.346	119,0 4.685	144,0 5.669	68,0 2.677	40,0 1.575	50,0 1.969	SPGX12T3	SCGX11T308	0,5 0.020	0,5 0.020
SD523-39-117-32R7	03080658	39,0 1.535	117,0 4.606	207,0 8.150	122,0 4.803	147,0 5.787	60,0 2.362	32,0 1.260	42,0 1.654	SPGX12T3	SCGX11T308	0,39 0.015	0,5 0.020
SD523-39-117-40R7	03080659	39,0 1.535	117,0 4.606	215,0 8.465	122,0 4.803	147,0 5.787	68,0 2.677	40,0 1.575	50,0 1.969	SPGX12T3	SCGX11T308	0,39 0.015	0,5 0.020
SD523-40-120-32R7	03080661	40,0 1.575	120,0 4.724	210,0 8.268	125,0 4.921	150,0 5.906	60,0 2.362	32,0 1.260	50,0 1.969	SPGX12T3	SCGX11T308	0,19 0.007	0,5 0.020
SD523-40-120-40R7	03080662	40,0 1.575	120,0 4.724	218,0 8.583	125,0 4.921	150,0 5.906	68,0 2.677	40,0 1.575	50,0 1.969	SPGX12T3	SCGX11T308	0,19 0.007	0,5 0.020
SD523-41-123-40R7	03080665	41,0 1.614	123,0 4.843	221,0 8.701	128,0 5.039	153,0 6.024	68,0 2.677	40,0 1.575	50,0 1.969	SPGX12T3	SCGX120408	0,19 0.007	0,5 0.020
SD523-41.5-125-40R7	03080663	41,5 1.634	125,0 4.921	223,0 8.780	130,0 5.118	155,0 6.102	68,0 2.677	40,0 1.575	50,0 1.969	SPGX12T3	SCGX120408	0,19 0.007	0,5 0.020
SD523-42-126-40R7	03080666	42,0 1.654	126,0 4.961	224,0 8.819	131,0 5.157	156,0 6.142	68,0 2.677	40,0 1.575	50,0 1.969	SPGX12T3	SCGX120408	0,19 0.007	0,5 0.020
SD523-43-129-40R7	03080667	43,0 1.693	129,0 5.079	227,0 8.937	134,0 5.276	159,0 6.260	68,0 2.677	40,0 1.575	50,0 1.969	SPGX12T3	SCGX120408	0,05 0.002	0,5 0.020
SD523-44-132-40R7	03080670	44,0 1.732	132,0 5.197	230,0 9.055	137,0 5.394	162,0 6.378	68,0 2.677	40,0 1.575	50,0 1.969	SPGX1504	SCGX120408	0,5 0.020	0,41 0.016
SD523-44.5-134-40R7	03080669	44,5 1.752	134,0 5.276	232,0 9.134	139,0 5.472	164,0 6.457	68,0 2.677	40,0 1.575	50,0 1.969	SPGX1504	SCGX150512	0,5 0.020	0,41 0.016
SD523-45-135-40R7	03080672	45,0 1.772	135,0 5.315	233,0 9.173	140,0 5.512	165,0 6.496	68,0 2.677	40,0 1.575	50,0 1.969	SPGX1504	SCGX150512	0,5 0.020	0,41 0.016
SD523-46-138-40R7	03080673	46,0 1.811	138,0 5.433	236,0 9.291	143,0 5.630	168,0 6.614	68,0 2.677	40,0 1.575	50,0 1.969	SPGX1504	SCGX150512	0,5 0.020	0,5 0.020
SD523-47-141-40R7	03080675	47,0 1.850	141,0 5.551	239,0 9.409	146,0 5.748	171,0 6.732	68,0 2.677	40,0 1.575	50,0 1.969	SPGX1504	SCGX150512	0,5 0.020	0,5 0.020
SD523-47.5-143-40R7	03080674	47,5 1.870	143,0 5.630	241,0 9.488	148,0 5.827	173,0 6.811	68,0 2.677	40,0 1.575	50,0 1.969	SPGX1504	SCGX150512	0,5 0.020	0,5 0.020
SD523-48-144-40R7	03080676	48,0 1.890	144,0 5.669	242,0 9.528	149,0 5.866	174,0 6.850	68,0 2.677	40,0 1.575	59,35 2.337	SPGX1504	SCGX150512	0,45 0.018	0,5 0.020
SD523-49-147-40R7	03080677	49,0 1.929	147,0 5.787	245,0 9.646	152,0 5.984	177,0 6.969	68,0 2.677	40,0 1.575	59,35 2.337	SPGX1504	SCGX150512	0,2 0.008	0,5 0.020
SD523-50-150-40R7	03080678	50,0 1.969	150,0 5.906	248,0 9.764	155,0 6.102	180,0 7.087	68,0 2.677	40,0 1.575	59,35 2.337	SPGX1504	SCGX150512	0,2 0.008	0,5 0.020
SD523-51-153-40R7	03080679	51,0 2.008	153,0 6.024	251,0 9.882	158,0 6.220	183,0 7.205	68,0 2.677	40,0 1.575	59,35 2.337	SPGX1504	SCGX150512	0,2 0.008	0,5 0.020
SD523-52-156-40R7	03080680	52,0 2.047	156,0 6.142	254,0 10.000	161,0 6.339	186,0 7.323	68,0 2.677	40,0 1.575	59,35 2.337	SPGX1904	SCGX150512	0,5 0.020	0,42 0.017
SD523-53-159-40R7	03080681	53,0 2.087	159,0 6.260	257,0 10.118	164,0 6.457	189,0 7.441	68,0 2.677	40,0 1.575	59,35 2.337	SPGX1904	SCGX150512	0,5 0.020	0,42 0.017
SD523-54-162-40R7	03080682	54,0 2.126	162,0 6.378	260,0 10.236	167,0 6.575	192,0 7.559	68,0 2.677	40,0 1.575	59,35 2.337	SPGX1904	SCGX150512	0,5 0.020	0,5 0.020
SD523-55-165-40R7	03080683	55,0 2.165	165,0 6.496	263,0 10.354	170,0 6.693	195,0 7.677	68,0 2.677	40,0 1.575	59,35 2.337	SPGX1904	SCGX150512	0,5 0.020	0,5 0.020
SD523-56-168-40R7	03080684	56,0 2.205	168,0 6.614	266,0 10.472	173,0 6.811	198,0 7.795	68,0 2.677	40,0 1.575	59,35 2.337	SPGX1904	SCGX150512	0,5 0.020	0,5 0.020
SD523-57-171-40R7	03080685	57,0 2.244	171,0 6.732	269,0 10.591	176,0 6.929	201,0 7.913	68,0 2.677	40,0 1.575	59,35 2.337	SPGX1904	SCGX150512	0,39 0.015	0,5 0.020

Introduzione

Foratura

Alesatura

Barenatura

Allegato

Introduzione

Codice di ordinazione	Codice prodotto	DC	LU	OAL	LUX	LFS	LS	DMM	DF	Inserto		Regolazione radiale	
		mm Inch	mm Inch	mm Inch	mm Inch	mm Inch	mm Inch	mm Inch	mm Inch	mm Inch	mm - Inch -	mm + Inch +	
SD523-58-174-40R7	03080686	58,0 2.283	174,0 6.850	272,0 10.709	179,0 7.047	204,0 8.031	68,0 2.677	40,0 1.575	63,0 2.480	SPGX1904	SCGX150512	0,09 0.004	0,5 0.020
SD523-59-177-40R7	03080687	59,0 2.323	177,0 6.969	275,0 10.827	182,0 7.165	207,0 8.150	68,0 2.677	40,0 1.575	63,0 2.480	SPGX1904	SCGX150512	0,09 0.004	0,5 0.020

Parti di ricambio, comprese nella fornitura

Per punta diametro (mm)	Vite di bloccaggio inserto		Chiave per vite inserto
			
	Inserto centrale	Inserto periferico	
15,00-17,45	C02245-T07P	C02245-T07P	T07P-2
17,46-19,49	C02205-T07P	C02245-T07P	T07P-2
19,50-21,24	C02205-T07P	C02205-T07P	T07P-2
21,25-22,49	C02506-T08P	C02506-T08P	T08P-2
22,50-25,49	C02507-T08P	C03007-T08P	T08P-2
25,50-28,49	C03007-T09P	C03007-T09P	T09P-2
28,50-31,49	C03007-T09P	C03009-T09P	T09P-2
31,50-40,49	C03508-T15P	C03508-T15P	T15P-2D
40,50-43,24	C03508-T15P	C05012-T15P	T15P-2D
43,25-59,00	C04011-T15P	C05012-T15P	T15P-2D

Accessori

Per punta diametro (mm)	Chiave dinamometrica*	Bit sostituibile	Valore di coppia
			
15,00-17,45	T00-07P09	T00-07P	0,9 Nm
17,46-19,49	T00-07P09	T00-07P	0,9 Nm
19,50-21,24	T00-07P09	T00-07P	0,9 Nm
21,25-22,49	T00-08P12	T00-08P	1,2 Nm
22,50-25,49	T00-08P12	T00-08P	1,2 Nm
25,50-28,49	T00-09P20	T00-09P	2,0 Nm
28,50-31,49	T00-09P20	T00-09P	2,0 Nm
31,50-40,49	T00-15P30	T00-15P	3,0 Nm
40,50-43,24	T00-15P30	T00-15P	3,0 Nm
43,25-59,00	T00-15P30	T00-15P	3,0 Nm

*Lama inclusa.

Allegato

Barenatura

Alesatura

Foratura

SD523

Profondità di foratura ~ 3 x D – Pollici

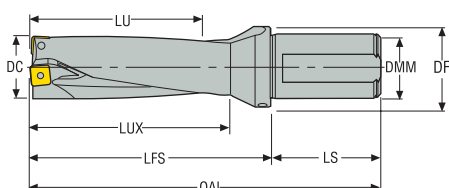

- Codolo ISO 9766, -7
- Adduzione refrigerante interna
- Per le informazioni sugli inserti, vedere pagina(e) 297-303
- Per i parametri di taglio raccomandati, vedere pagina(e) 306-307
- Per i diametri intermedi, utilizzare MyDesign.

Codice di ordinazione	Codice prodotto	DC	LU	OAL	LUX	LFS	LS	DMM	DF	Inserto		Regolazione radiale	
										Inserto centrale	Inserto periferico	Inch -	Inch +
SD523-0562-169-1000R7	03080485	0.562	1.686	5.117	1.883	2.867	2.250	1.000	1.378	SPGX0502	SCGX050204	0.011	0.009
SD523-0594-178-1000R7	03080486	0.594	1.780	5.211	1.977	2.961	2.250	1.000	1.378	SPGX0502	SCGX050204	0.008	0.013
SD523-0625-188-1000R7	03080488	0.625	1.880	5.311	2.077	3.061	2.250	1.000	1.378	SPGX0502	SCGX050204	0.005	0.015
SD523-0656-197-1000R7	03080490	0.656	1.970	5.401	2.167	3.151	2.250	1.000	1.378	SPGX0502	SCGX050204	0.002	0.019
SD523-0687-206-1000R7	03080493	0.687	2.030	5.461	2.227	3.211	2.250	1.000	1.378	SPGX0502	SCGX050204	0	0.020
SD523-0709-213-1000R7	03080494	0.709	2.130	5.561	2.327	3.311	2.250	1.000	1.378	SPGX0602	SCGX050204	0.013	0.008
SD523-0750-225-1000R7	03080497	0.750	2.250	5.681	2.447	3.431	2.250	1.000	1.378	SPGX0602	SCGX050204	0.004	0.017
SD523-0766-230-1000R7	03080499	0.766	2.300	5.731	2.497	3.481	2.250	1.000	1.378	SPGX0602	SCGX050204	0.001	0.020
SD523-0787-236-1000R7	03080501	0.787	2.360	5.791	2.557	3.541	2.250	1.000	1.378	SPGX0602	SCGX060204	0.003	0.018
SD523-0812-244-1000R7	03080503	0.812	2.440	5.871	2.637	3.621	2.250	1.000	1.378	SPGX0602	SCGX060204	0.001	0.020
SD523-0827-248-1000R7	03080505	0.827	2.480	5.911	2.677	3.661	2.250	1.000	1.378	SPGX0602	SCGX060204	0	0.020
SD523-0875-263-1000R7	03080507	0.875	2.630	6.061	2.827	3.811	2.250	1.000	1.378	SPGX0703	SCGX060204	0.015	0.020
SD523-0906-272-1000R7	03080509	0.906	2.720	6.151	2.917	3.901	2.250	1.000	1.378	SPGX0703	SCGX070308	0.013	0.020
SD523-0922-276-1000R7	03080512	0.922	2.760	6.191	2.957	3.941	2.250	1.000	1.378	SPGX0703	SCGX070308	0.010	0.020
SD523-0937-281-1000R7	03080514	0.937	2.810	6.241	3.007	3.991	2.250	1.000	1.378	SPGX0703	SCGX070308	0.004	0.020
SD523-0984-295-1250R7	03080516	0.984	2.950	6.506	3.147	4.131	2.375	1.250	1.654	SPGX0703	SCGX070308	0.004	0.020
SD523-1000-300-1250R7	03080518	1.000	3.000	6.556	3.197	4.181	2.375	1.250	1.654	SPGX0703	SCGX070308	0.004	0.020
SD523-1032-310-1250R7	03080521	1.032	3.100	6.656	3.297	4.281	2.375	1.250	1.654	SPGX0903	SCGX070308	0.020	0.004
SD523-1062-319-1250R7	03080522	1.062	3.190	6.746	3.387	4.371	2.375	1.250	1.654	SPGX0903	SCGX070308	0.020	0.010
SD523-1109-332-1250R7	03080525	1.109	3.320	6.876	3.517	4.501	2.375	1.250	1.654	SPGX0903	SCGX070308	0.009	0.020
SD523-1125-338-1250R7	03080526	1.125	3.380	6.936	3.577	4.561	2.375	1.250	1.654	SPGX0903	SCGX09T308	0.008	0.020
SD523-1172-351-1250R7	03080528	1.172	3.510	7.066	3.707	4.691	2.375	1.250	1.654	SPGX0903	SCGX09T308	0.005	0.020
SD523-1187-356-1250R7	03080530	1.187	3.560	7.116	3.757	4.741	2.375	1.250	1.654	SPGX0903	SCGX09T308	0.005	0.020
SD523-1250-375-1500R7	03080533	1.250	3.750	7.556	3.947	4.931	2.625	1.500	1.969	SPGX11T3	SCGX09T308	0.020	0.011
SD523-1312-394-1500R7	03080535	1.312	3.940	7.746	4.137	5.121	2.625	1.500	1.969	SPGX11T3	SCGX09T308	0.020	0.020
SD523-1344-403-1500R7	03080537	1.344	4.030	7.836	4.227	5.211	2.625	1.500	1.969	SPGX11T3	SCGX09T308	0.006	0.020
SD523-1375-413-1500R7	03080539	1.375	4.130	7.936	4.327	5.311	2.625	1.500	1.969	SPGX11T3	SCGX11T308	0.009	0.020
SD523-1422-426-1500R7	03080541	1.422	4.260	8.066	4.457	5.441	2.625	1.500	1.969	SPGX11T3	SCGX11T308	0.004	0.020
SD523-1437-431-1500R7	03080542	1.437	4.310	8.116	4.507	5.491	2.625	1.500	1.969	SPGX11T3	SCGX11T308	0.004	0.020
SD523-1500-450-1500R7	03080547	1.500	4.500	8.306	4.697	5.681	2.625	1.500	1.969	SPGX12T3	SCGX11T308	0.020	0.020
SD523-1562-469-1500R7	03080550	1.562	4.690	8.496	4.887	5.871	2.625	1.500	1.969	SPGX12T3	SCGX11T308	0.010	0.020
SD523-1625-488-1500R7	03080555	1.625	4.880	8.686	5.077	6.061	2.625	1.500	1.969	SPGX12T3	SCGX120408	0.007	0.020
SD523-1687-506-1500R7	03080560	1.687	5.060	8.866	5.257	6.241	2.625	1.500	1.969	SPGX12T3	SCGX120408	0.004	0.020
SD523-1750-525-1500R7	03080565	1.750	5.250	9.056	5.447	6.431	2.625	1.500	1.969	SPGX1504	SCGX120408	0.020	0.016
SD523-1812-544-1500R7	03080572	1.812	5.440	9.246	5.637	6.621	2.625	1.500	1.969	SPGX1504	SCGX150512	0.020	0.020
SD523-1875-563-1500R7	03080577	1.875	5.630	9.436	5.827	6.811	2.625	1.500	1.969	SPGX1504	SCGX150512	0.020	0.020

Introduzione

Foratura

Alesatura

Barenatura

Allegato

Introduzione

Codice di ordinazione	Codice prodotto	DC	LU	OAL	LUX	LFS	LS	DMM	DF	Inserto		Regolazione radiale	
		Inch	Inch	Inch	Inch	Inch	Inch	Inch	Inch	Inserto centrale	Inserto periferico	Inch -	Inch +
SD523-1937-581-1500R7	03080581	1.937	5.810	9.616	6.007	6.991	2.625	1.500	2.337	SPGX1504	SCGX150512	0.008	0.020
SD523-2000-600-1500R7	03080588	2.000	6.000	9.806	6.197	7.181	2.625	1.500	2.337	SPGX1504	SCGX150512	0.008	0.020
SD523-2062-619-1500R7	03080593	2.062	6.190	9.996	6.387	7.371	2.625	1.500	2.337	SPGX1904	SCGX150512	0.020	0.017
SD523-2125-638-1500R7	03080596	2.125	6.380	10.186	6.577	7.561	2.625	1.500	2.337	SPGX1904	SCGX150512	0.020	0.020
SD523-2250-675-1500R7	03080603	2.250	6.750	10.556	6.947	7.931	2.625	1.500	2.337	SPGX1904	SCGX150512	0.013	0.020
SD523-2375-713-1500R7	03080609	2.375	7.130	10.936	7.327	8.311	2.625	1.500	2.480	SPGX1904	SCGX150512	0.004	0.020

Parti di ricambio, comprese nella fornitura

Foratura

Per punta diametro (pollici)	Vite di bloccaggio inserto centrale	Vite di bloccaggio inserto periferico	Chiave
0.562-0.687	C02245-T07P	C02245-T07P	T07P-2
0.709-0.766	C02205-T07P	C02245-T07P	T07P-2
0.787-0.827	C02205-T07P	C02205-T07P	T07P-2
0.875	C02506-T08P	C02506-T08P	T08P-2
0.906	C02507-T08P	C03007-T08P	T08P-2
0.922	C02507-T08P	C03007-T08P	T08P-2
0.937-1.000	C02507-T08P	C03007-T08P	T08P-2
1.032-1.109	C03007-T09P	C03007-T09P	T09P-2
1.125-1.187	C03007-T09P	C03009-T09P	T09P-2
1.250-1.562	C03508-T15P	C03508-T15P	T15P-2D
1.625-1.687	C03508-T15P	C05012-T15P	T15P-2D
1.750-2.375	C04011-T15P	C05012-T15P	T15P-2D

Alesatura

Accessori

Per punta diametro (pollici)	Bit	Chiave dinamometrica
0.562-0.687	T00-07P	T00-07P09
0.709-0.766	-	T00-07P09
0.787-0.827	-	T00-07P09
0.875	-	T00-08P12
0.906	-	T00-08P12
0.922	-	T00-08P12
0.937-1.000	-	T00-08P12
1.032-1.109	-	T00-09P20
1.125-1.187	-	T00-09P20
1.250-1.562	-	T00-15P30
1.625-1.687	-	T00-15P30
1.750-2.375	-	T00-15P35

Barenatura

Allegato

SD523

Profondità di foratura ~ 3 x D – Pollici

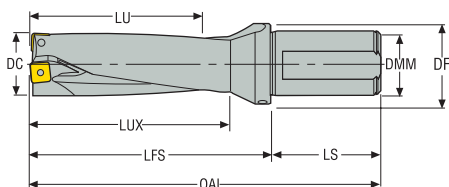

- Codolo ISO 9766, R7-C
- Adduzione refrigerante interna
- Per le informazioni sugli inserti, vedere pagina(e) 297-303
- Per i parametri di taglio raccomandati, vedere pagina(e) 306-307
- Per i diametri intermedi, utilizzare MyDesign.
- Per applicazioni statiche

Codice di ordinazione	Codice prodotto	DC	LU	OAL	LUX	LFS	LS	DMM	DF	Inserto		Regolazione radiale	
										Inserto centrale	Inserto periferico	Inch -	Inch +
SD523-0594-178-1000R7-C	03080487	0.594	1.780	5.908	1.977	3.158	2.750	1.000	1.378	SPGX0502	SCGX050204	0.008	0.013
SD523-0625-188-1000R7-C	03080489	0.625	1.880	6.008	2.077	3.258	2.750	1.000	1.378	SPGX0502	SCGX050204	0.005	0.015
SD523-0656-197-1000R7-C	03080491	0.656	1.970	6.098	2.167	3.348	2.750	1.000	1.378	SPGX0502	SCGX050204	0.002	0.019
SD523-0687-206-1000R7-C	03080492	0.687	2.060	6.188	2.257	3.438	2.750	1.000	1.378	SPGX0502	SCGX050204	0	0.020
SD523-0709-213-1000R7-C	03080495	0.709	2.130	6.258	2.327	3.508	2.750	1.000	1.378	SPGX0602	SCGX050204	0.013	0.008
SD523-0750-225-1000R7-C	03080496	0.750	2.250	6.378	2.447	3.628	2.750	1.000	1.378	SPGX0602	SCGX050204	0.004	0.017
SD523-0766-230-1000R7-C	03080500	0.766	2.300	6.428	2.497	3.678	2.750	1.000	1.378	SPGX0602	SCGX050204	0.001	0.020
SD523-0787-236-1000R7-C	03080502	0.787	2.360	6.488	2.557	3.738	2.750	1.000	1.378	SPGX0602	SCGX060204	0.003	0.018
SD523-0812-244-1000R7-C	03080504	0.812	2.440	6.568	2.637	3.818	2.750	1.000	1.378	SPGX0602	SCGX060204	0.001	0.020
SD523-0827-248-1000R7-C	03080506	0.827	2.480	6.608	2.677	3.858	2.750	1.000	1.378	SPGX0602	SCGX060204	0	0.020
SD523-0875-263-1000R7-C	03080508	0.875	2.630	6.758	2.827	4.008	2.750	1.000	1.378	SPGX0703	SCGX060204	0.015	0.020
SD523-0906-272-1000R7-C	03080511	0.906	2.720	6.848	2.917	4.098	2.750	1.000	1.378	SPGX0703	SCGX070308	0.013	0.020
SD523-0922-276-1000R7-C	03080513	0.922	2.760	6.888	2.957	4.138	2.750	1.000	1.378	SPGX0703	SCGX070308	0.010	0.020
SD523-0937-281-1000R7-C	03080515	0.937	2.810	6.938	3.007	4.188	2.750	1.000	1.378	SPGX0703	SCGX070308	0.004	0.020
SD523-0984-295-1250R7-C	03080517	0.984	2.950	7.078	3.147	4.328	2.750	1.250	1.654	SPGX0703	SCGX070308	0.004	0.020
SD523-1000-300-1250R7-C	03080519	1.000	3.000	7.128	3.197	4.378	2.750	1.250	1.654	SPGX0703	SCGX070308	0.004	0.020
SD523-1032-310-1250R7-C	03080520	1.032	3.100	7.228	3.297	4.478	2.750	1.250	1.654	SPGX0903	SCGX070308	0.020	0.004
SD523-1062-319-1250R7-C	03080523	1.062	3.190	7.318	3.387	4.568	2.750	1.250	1.654	SPGX0903	SCGX070308	0.020	0.010
SD523-1109-332-1250R7-C	03080524	1.109	3.320	7.448	3.517	4.698	2.750	1.250	1.654	SPGX0903	SCGX070308	0.009	0.020
SD523-1125-338-1250R7-C	03080527	1.125	3.380	7.508	3.577	4.758	2.750	1.250	1.654	SPGX0903	SCGX09T308	0.008	0.020
SD523-1172-351-1250R7-C	03080529	1.172	3.510	7.638	3.707	4.888	2.750	1.250	1.654	SPGX0903	SCGX09T308	0.005	0.020
SD523-1187-356-1250R7-C	03080531	1.187	3.560	7.688	3.757	4.938	2.750	1.250	1.654	SPGX0903	SCGX09T308	0.005	0.020
SD523-1250-375-1500R7-C	03080532	1.250	3.750	7.878	3.947	5.128	2.750	1.500	1.969	SPGX11T3	SCGX09T308	0.020	0.011
SD523-1312-394-1500R7-C	03080536	1.312	3.940	8.068	4.137	5.318	2.750	1.500	1.969	SPGX11T3	SCGX09T308	0.020	0.020
SD523-1344-403-1500R7-C	03080538	1.344	4.030	8.158	4.227	5.408	2.750	1.500	1.969	SPGX11T3	SCGX09T308	0.006	0.020
SD523-1375-413-1500R7-C	03080540	1.375	4.130	8.258	4.327	5.508	2.750	1.500	1.969	SPGX11T3	SCGX11T308	0.009	0.020
SD523-1422-426-1500R7-C	03080900	1.422	4.260	8.388	4.457	5.638	2.750	1.500	1.969	SPGX11T3	SCGX11T308	0.004	0.020
SD523-1437-431-1500R7-C	03080543	1.437	4.310	8.438	4.507	5.688	2.750	1.500	1.969	SPGX11T3	SCGX11T308	0.004	0.020
SD523-1500-450-1500R7-C	03080546	1.500	4.500	8.628	4.697	5.878	2.750	1.500	1.969	SPGX12T3	SCGX11T308	0.020	0.020
SD523-1562-469-1500R7-C	03080551	1.562	4.690	8.818	4.887	6.068	2.750	1.500	1.969	SPGX12T3	SCGX11T308	0.010	0.020
SD523-1625-488-1500R7-C	03080556	1.625	4.880	9.008	5.077	6.258	2.750	1.500	1.969	SPGX12T3	SCGX120408	0.007	0.020
SD523-1687-506-1500R7-C	03080561	1.687	5.060	9.188	5.257	6.438	2.750	1.500	1.969	SPGX12T3	SCGX120408	0.004	0.020
SD523-1750-525-1500R7-C	03080566	1.750	5.250	9.378	5.447	6.628	2.750	1.500	1.969	SPGX1504	SCGX120408	0.020	0.016
SD523-1812-544-1500R7-C	03080573	1.812	5.440	9.568	5.637	6.818	2.750	1.500	1.969	SPGX1504	SCGX150512	0.020	0.020
SD523-1875-563-1500R7-C	03080578	1.875	5.630	9.758	5.827	7.008	2.750	1.500	1.969	SPGX1504	SCGX150512	0.020	0.020

Introduzione

Foratura

Alesatura

Barenatura

Allegato

Introduzione

Codice di ordinazione	Codice prodotto	DC	LU	OAL	LUX	LFS	LS	DMM	DF	Inserto		Regolazione radiale	
		Inch	Inch	Inch	Inch	Inch	Inch	Inch	Inch	Inserto centrale	Inserto periferico	Inch -	Inch +
SD523-1937-581-1500R7-C	03080582	1.937	5.810	9.938	6.007	7.188	2.750	1.500	2.337	SPGX1504	SCGX150512	0.008	0.020
SD523-2000-600-1500R7-C	03080589	2.000	6.000	10.128	6.197	7.378	2.750	1.500	2.337	SPGX1504	SCGX150512	0.008	0.020
SD523-2125-638-1500R7-C	03080598	2.125	6.380	10.508	6.577	7.758	2.750	1.500	2.337	SPGX1904	SCGX150512	0.020	0.020
SD523-2250-675-1500R7-C	03080604	2.250	6.750	10.878	6.947	8.128	2.750	1.500	2.337	SPGX1904	SCGX150512	0.013	0.020
SD523-2375-713-1500R7-C	03080610	2.375	7.130	11.258	7.327	8.508	2.750	1.500	2.480	SPGX1904	SCGX150512	0.004	0.020

Parti di ricambio, comprese nella fornitura

Foratura

Per punta diametro (pollici)	Vite di bloccaggio inserto centrale	Vite di bloccaggio inserto periferico	Chiave	Grano
0.594-0.687	C02245-T07P	C02245-T07P	T07P-2	R1/4
0.709-0.766	C02205-T07P	C02245-T07P	T07P-2	R1/4
0.787-0.827	C02205-T07P	C02205-T07P	T07P-2	R1/4
0.875	C02506-T08P	C02506-T08P	T08P-2	R1/4
0.906-0.922	C02507-T08P	C03007-T08P	T08P-2	R1/4
0.906-0.922	C02506-T08P	C03007-T08P	T08P-2	R1/4
0.937-1.000	C02507-T08P	C03007-T08P	T08P-2	R1/4
1.032-1.109	C03007-T09P	-	T09P-2	R1/4
1.125-1.187	C03007-T09P	C03009-T09P	T09P-2	R1/4
1.250-1.562	C03508-T15P	-	T15P-2D	R1/4
1.625-1.687	C03508-T15P	C05012-T15P	T15P-2D	R1/4
1.750-2.375	C04011-T15P	C05012-T15P	T15P-2D	R1/4

Alesatura

Accessori

Per punta diametro (pollici)	Adattatore	Chiave dinamometrica
0.594-0.687	1310	T00-07P09
0.709-0.766	1310	T00-07P09
0.787-0.827	1310	T00-07P09
0.875	1310	T00-08P12
0.906-0.922	1310	T00-08P12
0.937-1.000	1310	T00-08P12
1.032-1.109	1310	T00-09P20
1.125-1.187	1310	T00-09P20
1.250-1.562	1310	T00-15P30
1.625-1.687	1310	T00-15P30
1.750-2.375	1310	T00-15P35

Barenatura

Allegato

SD523

Profondità di foratura ~ 3 x D – Misure metriche/Pollici

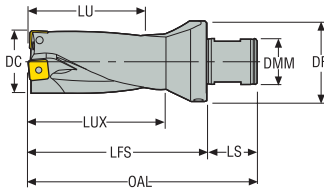

- Codolo compatibile ABS 50, -2
- Adduzione refrigerante interna
- Per le informazioni sugli inserti, vedere pagina(e) 297-303
- Per i parametri di taglio raccomandati, vedere pagina(e) 306-307
- Per i diametri intermedi, utilizzare MyDesign.

Codice di ordinazione	Codice prodotto	DC	LU	OAL	LUX	LFS	LS	DMM	DF	Inserto		Regolazione radiale	
										Inserto centrale	Inserto periferico	mm - Inch -	mm + Inch +
SD523-15-45-50R2	03080864	15,0 0.591	45,0 1.772	106,0 4.173	50,0 1.969	75,0 2.953	31,0 1.220	28,0 1.102	50,0 1.969	SPGX0502	SCGX050204	0,22 0.009	0,31 0.012
SD523-15.5-47-50R2	03080865	15,5 0.610	47,0 1.850	108,0 4.252	52,0 2.047	77,0 3.031	31,0 1.220	28,0 1.102	50,0 1.969	SPGX0502	SCGX050204	0,17 0.007	0,36 0.014
SD523-16-48-50R2	03080559	16,0 0.630	48,0 1.890	109,0 4.291	53,0 2.087	78,0 3.071	31,0 1.220	28,0 1.102	50,0 1.969	SPGX0502	SCGX050204	0,12 0.005	0,41 0.016
SD523-16.5-50-50R2	03080866	16,5 0.650	50,0 1.969	111,0 4.370	55,0 2.165	80,0 3.150	31,0 1.220	28,0 1.102	50,0 1.969	SPGX0502	SCGX050204	0,07 0.003	0,46 0.018
SD523-17-51-50R2	03080867	17,0 0.669	51,0 2.008	112,0 4.409	56,0 2.205	81,0 3.189	31,0 1.220	28,0 1.102	50,0 1.969	SPGX0502	SCGX050204	0,02 0.001	0,5 0.020
SD523-17.5-53-50R2	03080564	17,5 0.689	53,0 2.087	114,0 4.488	58,0 2.283	83,0 3.268	31,0 1.220	28,0 1.102	50,0 1.969	SPGX0602	SCGX050204	0,43 0.017	0,1 0.004
SD523-18-54-50R2	03080576	18,0 0.709	54,0 2.126	115,0 4.528	59,0 2.323	84,0 3.307	31,0 1.220	28,0 1.102	50,0 1.969	SPGX0602	SCGX050204	0,32 0.013	0,21 0.008
SD523-18.5-56-50R2	03080868	18,5 0.728	56,0 2.205	117,0 4.606	61,0 2.402	86,0 3.386	31,0 1.220	28,0 1.102	50,0 1.969	SPGX0602	SCGX050204	0,22 0.009	0,31 0.012
SD523-19-57-50R2	03080585	19,0 0.748	57,0 2.244	118,0 4.646	62,0 2.441	87,0 3.425	31,0 1.220	28,0 1.102	50,0 1.969	SPGX0602	SCGX050204	0,11 0.004	0,42 0.017
SD523-20-60-50R2	03080591	20,0 0.787	60,0 2.362	121,0 4.764	65,0 2.559	90,0 3.543	31,0 1.220	28,0 1.102	50,0 1.969	SPGX0602	SCGX060204	0,07 0.003	0,46 0.018
SD523-20.62-62-50R2	03080587	20,62 0.812	62,0 2.441	123,0 4.843	67,0 2.638	92,0 3.622	31,0 1.220	28,0 1.102	50,0 1.969	SPGX0602	SCGX060204	0,03 0.001	0,5 0.020
SD523-21-63-50R2	03080600	21,0 0.827	63,0 2.480	124,0 4.882	68,0 2.677	93,0 3.661	31,0 1.220	28,0 1.102	50,0 1.969	SPGX0602	SCGX060204	0,01 0	0,5 0.020
SD523-22-66-50R2	03080606	22,0 0.866	66,0 2.598	127,0 5.000	71,0 2.795	96,0 3.780	31,0 1.220	28,0 1.102	50,0 1.969	SPGX0703	SCGX060204	0,44 0.017	0,46 0.018
SD523-22.23-67-50R2	03080601	22,23 0.875	67,0 2.638	128,0 5.039	72,0 2.835	97,0 3.819	31,0 1.220	28,0 1.102	50,0 1.969	SPGX0703	SCGX060204	0,39 0.015	0,5 0.020
SD523-23-69-50R2	03080869	23,0 0.906	69,0 2.717	130,0 5.118	74,0 2.913	99,0 3.898	31,0 1.220	28,0 1.102	50,0 1.969	SPGX0703	SCGX070308	0,33 0.013	0,5 0.020
SD523-24-72-50R2	03080613	24,0 0.945	72,0 2.835	133,0 5.236	77,0 3.031	102,0 4.016	31,0 1.220	28,0 1.102	50,0 1.969	SPGX0703	SCGX070308	0,11 0.004	0,5 0.020
SD523-25-75-50R2	03080617	25,0 0.984	75,0 2.953	136,0 5.354	80,0 3.150	105,0 4.134	31,0 1.220	28,0 1.102	50,0 1.969	SPGX0703	SCGX070308	0,11 0.004	0,5 0.020
SD523-25.40-77-50R2	03080614	25,4 1.000	77,0 3.031	138,0 5.433	82,0 3.228	107,0 4.213	31,0 1.220	28,0 1.102	50,0 1.969	SPGX0703	SCGX070308	0,11 0.004	0,5 0.020
SD523-26-78-50R2	03080620	26,0 1.024	78,0 3.071	139,0 5.472	83,0 3.268	108,0 4.252	31,0 1.220	28,0 1.102	50,0 1.969	SPGX0903	SCGX070308	0,5 0.020	0,11 0.004
SD523-27-81-50R2	03080623	27,0 1.063	81,0 3.189	142,0 5.591	86,0 3.386	111,0 4.370	31,0 1.220	28,0 1.102	50,0 1.969	SPGX0903	SCGX070308	0,5 0.020	0,26 0.010
SD523-28-84-50R2	03080627	28,0 1.102	84,0 3.307	145,0 5.709	89,0 3.504	114,0 4.488	31,0 1.220	28,0 1.102	50,0 1.969	SPGX0903	SCGX070308	0,28 0.011	0,5 0.020
SD523-28.59-86-50R2	03080625	28,59 1.126	86,0 3.386	147,0 5.787	91,0 3.583	116,0 4.567	31,0 1.220	28,0 1.102	50,0 1.969	SPGX0903	SCGX09T308	0,21 0.008	0,5 0.020

Introduzione

Foratura

Alesatura

Barenatura



Allegato

Codice di ordinazione	Codice prodotto	DC	LU	OAL	LUX	LFS	LS	DMM	DF	Inserto		Regolazione radiale	
		mm Inch	mm Inch	mm Inch	mm Inch	mm Inch	mm Inch	mm Inch	mm Inch	mm Inch	mm - Inch -	mm + Inch +	
SD523-29-87-50R2	03080630	29,0 1.142	87,0 3.425	148,0 5.827	92,0 3.622	117,0 4.606	31,0 1.220	28,0 1.102	50,0 1.969	SPGX0903	SCGX09T308	0,18 0.007	0,5 0.020
SD523-30-90-50R2	03080633	30,0 1.181	90,0 3.543	151,0 5.945	95,0 3.740	120,0 4.724	31,0 1.220	28,0 1.102	50,0 1.969	SPGX0903	SCGX09T308	0,12 0.005	0,5 0.020
SD523-31-93-50R2	03080637	31,0 1.220	93,0 3.661	154,0 6.063	98,0 3.858	123,0 4.843	31,0 1.220	28,0 1.102	50,0 1.969	SPGX0903	SCGX09T308	0,12 0.005	0,5 0.020
SD523-31.75-96-50R2	03080635	31,75 1.250	96,0 3.780	157,0 6.181	101,0 3.976	126,0 4.961	31,0 1.220	28,0 1.102	50,0 1.969	SPGX11T3	SCGX09T308	0,5 0.020	0,28 0.011
SD523-32-96-50R2	03080640	32,0 1.260	96,0 3.780	157,0 6.181	101,0 3.976	126,0 4.961	31,0 1.220	28,0 1.102	50,0 1.969	SPGX11T3	SCGX09T308	0,5 0.020	0,31 0.012
SD523-33-99-50R2	03080643	33,0 1.299	99,0 3.898	160,0 6.299	104,0 4.094	129,0 5.079	31,0 1.220	28,0 1.102	50,0 1.969	SPGX11T3	SCGX09T308	0,5 0.020	0,46 0.018
SD523-34-102-50R2	03080646	34,0 1.339	102,0 4.016	163,0 6.417	107,0 4.213	132,0 5.197	31,0 1.220	28,0 1.102	50,0 1.969	SPGX11T3	SCGX09T308	0,22 0.009	0,5 0.020
SD523-35-105-50R2	03080650	35,0 1.378	105,0 4.134	166,0 6.535	110,0 4.331	135,0 5.315	31,0 1.220	28,0 1.102	50,0 1.969	SPGX11T3	SCGX11T308	0,22 0.009	0,5 0.020
SD523-36-108-50R2	03080870	36,0 1.417	108,0 4.252	169,0 6.654	113,0 4.449	138,0 5.433	31,0 1.220	28,0 1.102	50,0 1.969	SPGX11T3	SCGX11T308	0,09 0.004	0,5 0.020
SD523-37-111-50R2	03080871	37,0 1.457	111,0 4.370	172,0 6.772	116,0 4.567	141,0 5.551	31,0 1.220	28,0 1.102	50,0 1.969	SPGX11T3	SCGX11T308	0,09 0.004	0,5 0.020
SD523-38-114-50R2	03080657	38,0 1.496	114,0 4.488	175,0 6.890	119,0 4.685	144,0 5.669	31,0 1.220	28,0 1.102	50,0 1.969	SPGX12T3	SCGX11T308	0,5 0.020	0,5 0.020
SD523-39-117-50R2	03080660	39,0 1.535	117,0 4.606	178,0 7.008	122,0 4.803	147,0 5.787	31,0 1.220	28,0 1.102	50,0 1.969	SPGX12T3	SCGX11T308	0,39 0.015	0,5 0.020
SD523-40-120-50R2	03080872	40,0 1.575	120,0 4.724	181,0 7.126	125,0 4.921	150,0 5.906	31,0 1.220	28,0 1.102	50,0 1.969	SPGX12T3	SCGX11T308	0,19 0.007	0,5 0.020
SD523-41-123-50R2	03080873	41,0 1.614	123,0 4.843	184,0 7.244	128,0 5.039	153,0 6.024	31,0 1.220	28,0 1.102	50,0 1.969	SPGX12T3	SCGX120408	0,19 0.007	0,5 0.020
SD523-42-126-50R2	03080874	42,0 1.654	126,0 4.961	187,0 7.362	131,0 5.157	156,0 6.142	31,0 1.220	28,0 1.102	50,0 1.969	SPGX12T3	SCGX120408	0,19 0.007	0,5 0.020
SD523-43-129-50R2	03080875	43,0 1.693	129,0 5.079	190,0 7.480	134,0 5.276	159,0 6.260	31,0 1.220	28,0 1.102	50,0 1.969	SPGX12T3	SCGX120408	0,05 0.002	0,5 0.020
SD523-44-132-50R2	03080671	44,0 1.732	132,0 5.197	193,0 7.598	137,0 5.394	162,0 6.378	31,0 1.220	28,0 1.102	50,0 1.969	SPGX1504	SCGX120408	0,5 0.020	0,41 0.016
SD523-44.45-134-50R2	03080668	44,45 1.750	134,0 5.276	195,0 7.677	139,0 5.472	164,0 6.457	31,0 1.220	28,0 1.102	50,0 1.969	SPGX1504	SCGX120408	0,5 0.020	0,41 0.016

Parti di ricambio, comprese nella fornitura

Per punta diametro (mm)	Vite di bloccaggio inserto		Chiave per vite inserto
			
	Inserto centrale	Inserto periferico	
15,00-17,45	C02245-T07P	C02245-T07P	T07P-2
17,46-19,49	C02205-T07P	C02245-T07P	T07P-2
19,50-21,24	C02205-T07P	C02205-T07P	T07P-2
21,25-22,49	C02506-T08P	C02506-T08P	T08P-2
22,50-25,49	C02507-T08P	C03007-T08P	T08P-2
25,50-28,49	C03007-T09P	C03007-T09P	T09P-2
28,50-31,49	C03007-T09P	C03009-T09P	T09P-2
31,50-40,49	C03508-T15P	C03508-T15P	T15P-2D
40,50-43,24	C03508-T15P	C05012-T15P	T15P-2D
43,25-59,00	C04011-T15P	C05012-T15P	T15P-2D

Accessori

Per punta diametro (mm)	Chiave dinamometrica*	Bit sostituibile	Valore di coppia
			
15,00-17,45	T00-07P09	T00-07P	0,9 Nm
17,46-19,49	T00-07P09	T00-07P	0,9 Nm
19,50-21,24	T00-07P09	T00-07P	0,9 Nm
21,25-22,49	T00-08P12	T00-08P	1,2 Nm
22,50-25,49	T00-08P12	T00-08P	1,2 Nm
25,50-28,49	T00-09P20	T00-09P	2,0 Nm
28,50-31,49	T00-09P20	T00-09P	2,0 Nm
31,50-40,49	T00-15P30	T00-15P	3,0 Nm
40,50-43,24	T00-15P30	T00-15P	3,0 Nm
43,25-59,00	T00-15P30	T00-15P	3,0 Nm

*Lama inclusa.

Introduzione

Foratura

Alesatura

Barenatura

Allegato

SD523

Profondità di foratura ~ 3 x D – Misure metriche/Pollici

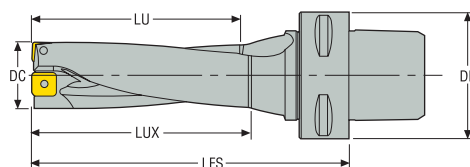

- Codolo C4 Seco-Capto™
- Adduzione refrigerante interna
- Per le informazioni sugli inserti, vedere pagina(e) 297-303
- Per i parametri di taglio raccomandati, vedere pagina(e) 306-307
- Per i diametri intermedi, utilizzare MyDesign.

Codice di ordinazione	Codice prodotto	DC	LU	LUX	LFS	DF	Inserto		Regolazione radiale	
							Inserto centrale	Inserto periferico	mm - Inch -	mm + Inch +
SD523-15-45-C4	03080920	15,0 0.591	45,0 1.772	50,0 1.969	82,0 3.228	40,0 1.575	SPGX0502	SCGX050204	0,22 0.009	0,31 0.012
SD523-15.5-47-C4	03080921	15,5 0.610	47,0 1.850	52,0 2.047	84,0 3.307	40,0 1.575	SPGX0502	SCGX050204	0,17 0.007	0,36 0.014
SD523-16-48-C4	03080922	16,0 0.630	48,0 1.890	53,0 2.087	86,0 3.386	40,0 1.575	SPGX0502	SCGX050204	0,12 0.005	0,41 0.016
SD523-16.5-50-C4	03080923	16,5 0.650	50,0 1.969	55,0 2.165	88,0 3.465	40,0 1.575	SPGX0502	SCGX050204	0,07 0.003	0,46 0.018
SD523-17-51-C4	03080925	17,0 0.669	51,0 2.008	56,0 2.205	89,0 3.504	40,0 1.575	SPGX0502	SCGX050204	0,02 0.001	0,5 0.020
SD523-17.5-53-C4	03080926	17,5 0.689	53,0 2.087	58,0 2.283	92,0 3.622	40,0 1.575	SPGX0602	SCGX050204	0,43 0.017	0,1 0.004
SD523-18-54-C4	03080927	18,0 0.709	54,0 2.126	59,0 2.323	93,0 3.661	40,0 1.575	SPGX0602	SCGX050204	0,32 0.013	0,21 0.008
SD523-18.5-56-C4	03080928	18,5 0.728	56,0 2.205	61,0 2.402	95,0 3.740	40,0 1.575	SPGX0602	SCGX050204	0,22 0.009	0,31 0.012
SD523-19-57-C4	03080929	19,0 0.748	57,0 2.244	62,0 2.441	96,0 3.780	40,0 1.575	SPGX0602	SCGX050204	0,11 0.004	0,42 0.017
SD523-20-60-C4	03080930	20,0 0.787	60,0 2.362	65,0 2.559	101,0 3.976	40,0 1.575	SPGX0602	SCGX060204	0,07 0.003	0,46 0.018
SD523-20.62-62-C4	03081006	20,62 0.812	62,0 2.441	67,0 2.638	103,0 4.055	40,0 1.575	SPGX0602	SCGX060204	0,03 0.001	0,5 0.020
SD523-21-63-C4	03080931	21,0 0.827	63,0 2.480	68,0 2.677	104,0 4.094	40,0 1.575	SPGX0602	SCGX060204	0,01 0	0,5 0.020
SD523-22-66-C4	03080932	22,0 0.866	66,0 2.598	71,0 2.795	107,0 4.213	40,0 1.575	SPGX0703	SCGX060204	0,44 0.017	0,46 0.018
SD523-22.23-67-C4	03081008	22,23 0.875	67,0 2.638	72,0 2.835	108,0 4.252	40,0 1.575	SPGX0703	SCGX060204	0,39 0.015	0,5 0.020
SD523-23-69-C4	03080933	23,0 0.906	69,0 2.717	74,0 2.913	111,0 4.370	40,0 1.575	SPGX0703	SCGX070308	0,33 0.013	0,5 0.020
SD523-24-72-C4	03080934	24,0 0.945	72,0 2.835	77,0 3.031	115,0 4.528	40,0 1.575	SPGX0703	SCGX070308	0,11 0.004	0,5 0.020
SD523-25-75-C4	03080935	25,0 0.984	75,0 2.953	80,0 3.150	119,0 4.685	40,0 1.575	SPGX0703	SCGX070308	0,11 0.004	0,5 0.020
SD523-25.4-77-C4	03081009	25,4 1.000	77,0 3.031	82,0 3.228	121,0 4.764	40,0 1.575	SPGX0703	SCGX070308	0,11 0.004	0,5 0.020
SD523-26-78-C4	03080936	26,0 1.024	78,0 3.071	83,0 3.268	122,0 4.803	40,0 1.575	SPGX0903	SCGX070308	0,5 0.020	0,11 0.004
SD523-27-81-C4	03080937	27,0 1.063	81,0 3.189	86,0 3.386	125,0 4.921	40,0 1.575	SPGX0903	SCGX070308	0,5 0.020	0,26 0.010
SD523-28-84-C4	03080938	28,0 1.102	84,0 3.307	89,0 3.504	129,0 5.079	40,0 1.575	SPGX0903	SCGX070308	0,28 0.011	0,5 0.020
SD523-28.59-86-C4	03081010	28,59 1.126	86,0 3.386	91,0 3.583	131,0 5.157	40,0 1.575	SPGX0903	SCGX09T308	0,21 0.008	0,5 0.020

Codice di ordinazione	Codice prodotto	DC	LU	LUX	LFS	DF	Inserto		Regolazione radiale	
		mm Inch	mm Inch	mm Inch	mm Inch	mm Inch	Inserto centrale	Inserto periferico	mm - Inch -	mm + Inch +
SD523-29-87-C4	03080939	29,0 1.142	87,0 3.425	92,0 3.622	132,0 5.197	40,0 1.575	SPGX0903	SCGX09T308	0,18 0.007	0,5 0.020
SD523-30-90-C4	03080940	30,0 1.181	90,0 3.543	95,0 3.740	135,0 5.315	40,0 1.575	SPGX0903	SCGX09T308	0,12 0.005	0,5 0.020

Parti di ricambio, comprese nella fornitura

Per punta diametro (mm)	Vite di bloccaggio inserto		Chiave per vite inserto
	Inserto centrale	Inserto periferico	
15,00-17,45	C02245-T07P	C02245-T07P	T07P-2
17,46-19,49	C02205-T07P	C02245-T07P	T07P-2
19,50-21,24	C02205-T07P	C02205-T07P	T07P-2
21,25-22,49	C02506-T08P	C02506-T08P	T08P-2
22,50-25,49	C02507-T08P	C03007-T08P	T08P-2
25,50-28,49	C03007-T09P	C03007-T09P	T09P-2
28,50-31,49	C03007-T09P	C03009-T09P	T09P-2
31,50-40,49	C03508-T15P	C03508-T15P	T15P-2D
40,50-43,24	C03508-T15P	C05012-T15P	T15P-2D
43,25-59,00	C04011-T15P	C05012-T15P	T15P-2D

Accessori

Per punta diametro (mm)	Chiave dinamometrica*	Bit sostituibile	Valore di coppia
15,00-17,45	T00-07P09	T00-07P	0,9 Nm
17,46-19,49	T00-07P09	T00-07P	0,9 Nm
19,50-21,24	T00-07P09	T00-07P	0,9 Nm
21,25-22,49	T00-08P12	T00-08P	1,2 Nm
22,50-25,49	T00-08P12	T00-08P	1,2 Nm
25,50-28,49	T00-09P20	T00-09P	2,0 Nm
28,50-31,49	T00-09P20	T00-09P	2,0 Nm
31,50-40,49	T00-15P30	T00-15P	3,0 Nm
40,50-43,24	T00-15P30	T00-15P	3,0 Nm
43,25-59,00	T00-15P30	T00-15P	3,0 Nm

*Lama inclusa.

Introduzione

Foratura

Alesatura

Barenatura

Allegato

SD523

Profondità di foratura ~ 3 x D – Misure metriche/Pollici

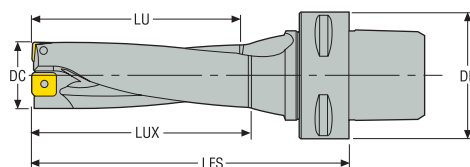

- Codolo C5 Seco-Capto™
- Addizione refrigerante interna
- Per le informazioni sugli inserti, vedere pagina(e) 297-303
- Per i parametri di taglio raccomandati, vedere pagina(e) 306-307
- Per i diametri intermedi, utilizzare MyDesign.

Codice di ordinazione	Codice prodotto	DC	LU	LUX	LFS	DF	Inserto		Regolazione radiale	
							Inserto centrale	Inserto periferico	mm - Inch -	mm + Inch +
SD523-15-45-C5	03080941	15,0 0.591	45,0 1.772	50,0 1.969	82,0 3.228	50,0 1.969	SPGX0502	SCGX050204	0,22 0.009	0,31 0.012
SD523-15.5-47-C5	03080942	15,5 0.610	47,0 1.850	52,0 2.047	84,0 3.307	50,0 1.969	SPGX0502	SCGX050204	0,17 0.007	0,36 0.014
SD523-16-48-C5	03080943	16,0 0.630	48,0 1.890	53,0 2.087	86,0 3.386	50,0 1.969	SPGX0502	SCGX050204	0,12 0.005	0,41 0.016
SD523-16.5-50-C5	03080944	16,5 0.650	50,0 1.969	55,0 2.165	88,0 3.465	50,0 1.969	SPGX0502	SCGX050204	0,07 0.003	0,46 0.018
SD523-17-51-C5	03080945	17,0 0.669	51,0 2.008	56,0 2.205	89,0 3.504	50,0 1.969	SPGX0502	SCGX050204	0,02 0.001	0,5 0.020
SD523-17.5-53-C5	03080946	17,5 0.689	53,0 2.087	58,0 2.283	92,0 3.622	50,0 1.969	SPGX0602	SCGX050204	0,43 0.017	0,1 0.004
SD523-18-54-C5	03080947	18,0 0.709	54,0 2.126	59,0 2.323	93,0 3.661	50,0 1.969	SPGX0602	SCGX050204	0,32 0.013	0,21 0.008
SD523-18.5-56-C5	03080948	18,5 0.728	56,0 2.205	61,0 2.402	95,0 3.740	50,0 1.969	SPGX0602	SCGX050204	0,22 0.009	0,31 0.012
SD523-19-57-C5	03080949	19,0 0.748	57,0 2.244	62,0 2.441	96,0 3.780	50,0 1.969	SPGX0602	SCGX050204	0,11 0.004	0,42 0.017
SD523-20-60-C5	03080950	20,0 0.787	60,0 2.362	65,0 2.559	101,0 3.976	50,0 1.969	SPGX0602	SCGX060204	0,07 0.003	0,46 0.018
SD523-20.62-62-C5	03081001	20,62 0.812	62,0 2.441	67,0 2.638	103,0 4.055	50,0 1.969	SPGX0602	SCGX060204	0,03 0.001	0,5 0.020
SD523-21-63-C5	03080951	21,0 0.827	63,0 2.480	68,0 2.677	104,0 4.094	50,0 1.969	SPGX0602	SCGX060204	0,01 0	0,5 0.020
SD523-22-66-C5	03080952	22,0 0.866	66,0 2.598	71,0 2.795	107,0 4.213	50,0 1.969	SPGX0703	SCGX060204	0,44 0.017	0,46 0.018
SD523-22.23-67-C5	03081002	22,23 0.875	67,0 2.638	72,0 2.835	108,0 4.252	50,0 1.969	SPGX0703	SCGX060204	0,39 0.015	0,5 0.020
SD523-23-69-C5	03080953	23,0 0.906	69,0 2.717	74,0 2.913	111,0 4.370	50,0 1.969	SPGX0703	SCGX070308	0,33 0.013	0,5 0.020
SD523-24-72-C5	03080954	24,0 0.945	72,0 2.835	77,0 3.031	115,0 4.528	50,0 1.969	SPGX0703	SCGX070308	0,11 0.004	0,5 0.020
SD523-25-75-C5	03080955	25,0 0.984	75,0 2.953	80,0 3.150	119,0 4.685	50,0 1.969	SPGX0703	SCGX070308	0,11 0.004	0,5 0.020
SD523-25.4-77-C5	03081003	25,4 1.000	77,0 3.031	82,0 3.228	121,0 4.764	50,0 1.969	SPGX0703	SCGX070308	0,11 0.004	0,5 0.020
SD523-26-78-C5	03080956	26,0 1.024	78,0 3.071	83,0 3.268	122,0 4.803	50,0 1.969	SPGX0903	SCGX070308	0,5 0.020	0,11 0.004
SD523-27-81-C5	03080957	27,0 1.063	81,0 3.189	86,0 3.386	125,0 4.921	50,0 1.969	SPGX0903	SCGX070308	0,5 0.020	0,26 0.010
SD523-28-84-C5	03080958	28,0 1.102	84,0 3.307	89,0 3.504	129,0 5.079	50,0 1.969	SPGX0903	SCGX070308	0,28 0.011	0,5 0.020
SD523-28.59-86-C5	03081004	28,59 1.126	86,0 3.386	91,0 3.583	131,0 5.157	50,0 1.969	SPGX0903	SCGX09T308	0,21 0.008	0,5 0.020



Codice di ordinazione	Codice prodotto	DC	LU	LUX	LFS	DF	Inserto		Regolazione radiale	
							Inserto centrale	Inserto periferico	mm - Inch -	mm + Inch +
SD523-29-87-C5	03080959	29,0 1.142	87,0 3.425	92,0 3.622	132,0 5.197	50,0 1.969	SPGX0903	SCGX09T308	0,18 0.007	0,5 0.020
SD523-30-90-C5	03080960	30,0 1.181	90,0 3.543	95,0 3.740	135,0 5.315	50,0 1.969	SPGX0903	SCGX09T308	0,12 0.005	0,5 0.020
SD523-31-93-C5	03080961	31,0 1.220	93,0 3.661	98,0 3.858	138,0 5.433	50,0 1.969	SPGX0903	SCGX09T308	0,12 0.005	0,5 0.020
SD523-31.75-96-C5	03081005	31,75 1.250	96,0 3.780	101,0 3.976	142,0 5.591	50,0 1.969	SPGX11T3	SCGX09T308	0,5 0.020	0,28 0.011
SD523-32-96-C5	03080962	32,0 1.260	96,0 3.780	101,0 3.976	142,0 5.591	50,0 1.969	SPGX11T3	SCGX09T308	0,5 0.020	0,31 0.012
SD523-33-99-C5	03080963	33,0 1.299	99,0 3.898	104,0 4.094	145,0 5.709	50,0 1.969	SPGX11T3	SCGX09T308	0,5 0.020	0,46 0.018
SD523-34-102-C5	03080964	34,0 1.339	102,0 4.016	107,0 4.213	148,0 5.827	50,0 1.969	SPGX11T3	SCGX09T308	0,22 0.009	0,5 0.020
SD523-35-105-C5	03080965	35,0 1.378	105,0 4.134	110,0 4.331	151,0 5.945	50,0 1.969	SPGX11T3	SCGX11T308	0,22 0.009	0,5 0.020
SD523-36-108-C5	03080966	36,0 1.417	108,0 4.252	113,0 4.449	154,0 6.063	50,0 1.969	SPGX11T3	SCGX11T308	0,09 0.004	0,5 0.020
SD523-37-111-C5	03080967	37,0 1.457	111,0 4.370	116,0 4.567	157,0 6.181	50,0 1.969	SPGX11T3	SCGX11T308	0,09 0.004	0,5 0.020
SD523-38-114-C5	03080968	38,0 1.496	114,0 4.488	119,0 4.685	160,0 6.299	50,0 1.969	SPGX12T3	SCGX11T308	0,5 0.020	0,5 0.020
SD523-39-117-C5	03080969	39,0 1.535	117,0 4.606	122,0 4.803	163,0 6.417	50,0 1.969	SPGX12T3	SCGX11T308	0,39 0.015	0,5 0.020
SD523-40-120-C5	03080970	40,0 1.575	120,0 4.724	125,0 4.921	166,0 6.535	50,0 1.969	SPGX12T3	SCGX11T308	0,19 0.007	0,5 0.020

Parti di ricambio, comprese nella fornitura

Per punta diametro (mm)	Vite di bloccaggio inserto		Chiave per vite inserto
	Inserto centrale	Inserto periferico	
15,00-17,45	C02245-T07P	C02245-T07P	T07P-2
17,46-19,49	C02205-T07P	C02245-T07P	T07P-2
19,50-21,24	C02205-T07P	C02205-T07P	T07P-2
21,25-22,49	C02506-T08P	C02506-T08P	T08P-2
22,50-25,49	C02507-T08P	C03007-T08P	T08P-2
25,50-28,49	C03007-T09P	C03007-T09P	T09P-2
28,50-31,49	C03007-T09P	C03009-T09P	T09P-2
31,50-40,49	C03508-T15P	C03508-T15P	T15P-2D
40,50-43,24	C03508-T15P	C05012-T15P	T15P-2D
43,25-59,00	C04011-T15P	C05012-T15P	T15P-2D



Accessori

Per punta diametro (mm)	Chiave dinamometrica*	Bit sostituibile	Valore di coppia
			
15,00-17,45	T00-07P09	T00-07P	0,9 Nm
17,46-19,49	T00-07P09	T00-07P	0,9 Nm
19,50-21,24	T00-07P09	T00-07P	0,9 Nm
21,25-22,49	T00-08P12	T00-08P	1,2 Nm
22,50-25,49	T00-08P12	T00-08P	1,2 Nm
25,50-28,49	T00-09P20	T00-09P	2,0 Nm
28,50-31,49	T00-09P20	T00-09P	2,0 Nm
31,50-40,49	T00-15P30	T00-15P	3,0 Nm
40,50-43,24	T00-15P30	T00-15P	3,0 Nm
43,25-59,00	T00-15P30	T00-15P	3,0 Nm

*Lama inclusa.

Introduzione

Foratura

Alesatura

Barenatura

Allegato

SD523

Profondità di foratura ~ 3 x D – Misure metriche/Pollici

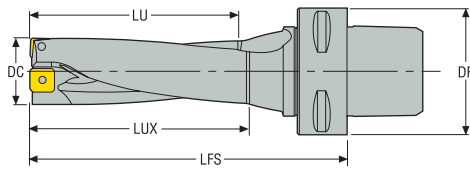

- Codolo C6 Seco-Capto™
- Adduzione refrigerante interna
- Per le informazioni sugli inserti, vedere pagina(e) 297-303
- Per i parametri di taglio raccomandati, vedere pagina(e) 306-307
- Per i diametri intermedi, utilizzare MyDesign.

Codice di ordinazione	Codice prodotto	DC	LU	LUX	LFS	DF	Inserto		Regolazione radiale	
							Inserto centrale	Inserto periferico	mm - Inch -	mm + Inch +
SD523-15-45-C6	03080971	15,0 0.591	45,0 1.772	50,0 1.969	84,0 3.307	63,0 2.480	SPGX0502	SCGX050204	0,22 0.009	0,31 0.012
SD523-15.5-47-C6	03080972	15,5 0.610	47,0 1.850	52,0 2.047	86,0 3.386	63,0 2.480	SPGX0502	SCGX050204	0,17 0.007	0,36 0.014
SD523-16-48-C6	03080973	16,0 0.630	48,0 1.890	53,0 2.087	88,0 3.465	63,0 2.480	SPGX0502	SCGX050204	0,12 0.005	0,41 0.016
SD523-16.5-50-C6	03080974	16,5 0.650	50,0 1.969	55,0 2.165	90,0 3.543	63,0 2.480	SPGX0502	SCGX050204	0,07 0.003	0,46 0.018
SD523-17-51-C6	03080975	17,0 0.669	51,0 2.008	56,0 2.205	91,0 3.583	63,0 2.480	SPGX0502	SCGX050204	0,02 0.001	0,5 0.020
SD523-17.5-53-C6	03080976	17,5 0.689	53,0 2.087	58,0 2.283	94,0 3.701	63,0 2.480	SPGX0602	SCGX050204	0,43 0.017	0,1 0.004
SD523-18-54-C6	03080977	18,0 0.709	54,0 2.126	59,0 2.323	95,0 3.740	63,0 2.480	SPGX0602	SCGX050204	0,32 0.013	0,21 0.008
SD523-18.5-56-C6	03080978	18,5 0.728	56,0 2.205	61,0 2.402	97,0 3.819	63,0 2.480	SPGX0602	SCGX050204	0,22 0.009	0,31 0.012
SD523-19-57-C6	03080979	19,0 0.748	57,0 2.244	62,0 2.441	98,0 3.858	63,0 2.480	SPGX0602	SCGX050204	0,11 0.004	0,42 0.017
SD523-20-60-C6	03080980	20,0 0.787	60,0 2.362	65,0 2.559	103,0 4.055	63,0 2.480	SPGX0602	SCGX060204	0,07 0.003	0,46 0.018
SD523-20.62-62-C6	03081011	20,62 0.812	62,0 2.441	67,0 2.638	105,0 4.134	63,0 2.480	SPGX0602	SCGX060204	0,03 0.001	0,5 0.020
SD523-21-63-C6	03080981	21,0 0.827	63,0 2.480	68,0 2.677	106,0 4.173	63,0 2.480	SPGX0602	SCGX060204	0,01 0	0,5 0.020
SD523-22-66-C6	03080982	22,0 0.866	66,0 2.598	71,0 2.795	109,0 4.291	63,0 2.480	SPGX0703	SCGX060204	0,44 0.017	0,46 0.018
SD523-22.23-67-C6	03081012	22,23 0.875	67,0 2.638	72,0 2.835	110,0 4.331	63,0 2.480	SPGX0703	SCGX060204	0,39 0.015	0,5 0.020
SD523-23-69-C6	03080983	23,0 0.906	69,0 2.717	74,0 2.913	113,0 4.449	63,0 2.480	SPGX0703	SCGX070308	0,33 0.013	0,5 0.020
SD523-24-72-C6	03080984	24,0 0.945	72,0 2.835	77,0 3.031	117,0 4.606	63,0 2.480	SPGX0703	SCGX070308	0,11 0.004	0,5 0.020
SD523-25-75-C6	03080985	25,0 0.984	75,0 2.953	80,0 3.150	121,0 4.764	63,0 2.480	SPGX0703	SCGX070308	0,11 0.004	0,5 0.020
SD523-25.4-77-C6	03081013	25,4 1.000	77,0 3.031	82,0 3.228	123,0 4.843	63,0 2.480	SPGX0703	SCGX070308	0,11 0.004	0,5 0.020
SD523-26-78-C6	03080986	26,0 1.024	78,0 3.071	83,0 3.268	124,0 4.882	63,0 2.480	SPGX0903	SCGX070308	0,5 0.020	0,11 0.004
SD523-27-81-C6	03080987	27,0 1.063	81,0 3.189	86,0 3.386	127,0 5.000	63,0 2.480	SPGX0903	SCGX070308	0,5 0.020	0,26 0.010
SD523-28-84-C6	03080988	28,0 1.102	84,0 3.307	89,0 3.504	131,0 5.157	63,0 2.480	SPGX0903	SCGX070308	0,28 0.011	0,5 0.020
SD523-28.59-86-C6	03081014	28,59 1.126	86,0 3.386	91,0 3.583	133,0 5.236	63,0 2.480	SPGX0903	SCGX09T308	0,21 0.008	0,5 0.020

Introduzione

Foratura

Alesatura

Barenatura

Allegato



Codice di ordinazione	Codice prodotto	DC	LU	LUX	LFS	DF	Inserto		Regolazione radiale	
		mm Inch	mm Inch	mm Inch	mm Inch	mm Inch	Inserto centrale	Inserto periferico	mm - Inch -	mm + Inch +
SD523-29-87-C6	03080989	29,0 1.142	87,0 3.425	92,0 3.622	134,0 5.276	63,0 2.480	SPGX0903	SCGX09T308	0,18 0.007	0,5 0.020
SD523-30-90-C6	03080990	30,0 1.181	90,0 3.543	95,0 3.740	137,0 5.394	63,0 2.480	SPGX0903	SCGX09T308	0,12 0.005	0,5 0.020
SD523-31-93-C6	03080991	31,0 1.220	93,0 3.661	98,0 3.858	140,0 5.512	63,0 2.480	SPGX0903	SCGX09T308	0,12 0.005	0,5 0.020
SD523-31.75-96-C6	03081015	31,75 1.250	96,0 3.780	101,0 3.976	144,0 5.669	63,0 2.480	SPGX11T3	SCGX09T308	0,5 0.020	0,28 0.011
SD523-32-96-C6	03080992	32,0 1.260	96,0 3.780	101,0 3.976	144,0 5.669	63,0 2.480	SPGX11T3	SCGX09T308	0,5 0.020	0,31 0.012
SD523-33-99-C6	03080993	33,0 1.299	99,0 3.898	104,0 4.094	147,0 5.787	63,0 2.480	SPGX11T3	SCGX09T308	0,5 0.020	0,46 0.018
SD523-34-102-C6	03080994	34,0 1.339	102,0 4.016	107,0 4.213	150,0 5.906	63,0 2.480	SPGX11T3	SCGX09T308	0,22 0.009	0,5 0.020
SD523-35-105-C6	03080995	35,0 1.378	105,0 4.134	110,0 4.331	153,0 6.024	63,0 2.480	SPGX11T3	SCGX11T308	0,22 0.009	0,5 0.020
SD523-36-108-C6	03080996	36,0 1.417	108,0 4.252	113,0 4.449	156,0 6.142	63,0 2.480	SPGX11T3	SCGX11T308	0,09 0.004	0,5 0.020
SD523-37-111-C6	03080997	37,0 1.457	111,0 4.370	116,0 4.567	159,0 6.260	63,0 2.480	SPGX11T3	SCGX11T308	0,09 0.004	0,5 0.020
SD523-38-114-C6	03080998	38,0 1.496	114,0 4.488	119,0 4.685	162,0 6.378	63,0 2.480	SPGX12T3	SCGX11T308	0,5 0.020	0,5 0.020
SD523-39-117-C6	03080999	39,0 1.535	117,0 4.606	122,0 4.803	165,0 6.496	63,0 2.480	SPGX12T3	SCGX11T308	0,39 0.015	0,5 0.020
SD523-40-120-C6	03081000	40,0 1.575	120,0 4.724	125,0 4.921	168,0 6.614	63,0 2.480	SPGX12T3	SCGX11T308	0,19 0.007	0,5 0.020

Parti di ricambio, comprese nella fornitura

Per punta diametro (mm)	Vite di bloccaggio inserto		Chiave per vite inserto
	Inserto centrale	Inserto periferico	
15,00-17,45	C02245-T07P	C02245-T07P	T07P-2
17,46-19,49	C02205-T07P	C02245-T07P	T07P-2
19,50-21,24	C02205-T07P	C02205-T07P	T07P-2
21,25-22,49	C02506-T08P	C02506-T08P	T08P-2
22,50-25,49	C02507-T08P	C03007-T08P	T08P-2
25,50-28,49	C03007-T09P	C03007-T09P	T09P-2
28,50-31,49	C03007-T09P	C03009-T09P	T09P-2
31,50-40,49	C03508-T15P	C03508-T15P	T15P-2D
40,50-43,24	C03508-T15P	C05012-T15P	T15P-2D
43,25-59,00	C04011-T15P	C05012-T15P	T15P-2D



Accessori

Per punta diametro (mm)	Chiave dinamometrica*	Bit sostituibile	Valore di coppia
			
15,00-17,45	T00-07P09	T00-07P	0,9 Nm
17,46-19,49	T00-07P09	T00-07P	0,9 Nm
19,50-21,24	T00-07P09	T00-07P	0,9 Nm
21,25-22,49	T00-08P12	T00-08P	1,2 Nm
22,50-25,49	T00-08P12	T00-08P	1,2 Nm
25,50-28,49	T00-09P20	T00-09P	2,0 Nm
28,50-31,49	T00-09P20	T00-09P	2,0 Nm
31,50-40,49	T00-15P30	T00-15P	3,0 Nm
40,50-43,24	T00-15P30	T00-15P	3,0 Nm
43,25-59,00	T00-15P30	T00-15P	3,0 Nm

*Lama inclusa.

Introduzione

Foratura

Alesatura

Barenatura

Allegato

SD524

Profondità di foratura ~ 4 x D – Misure metriche/Pollici

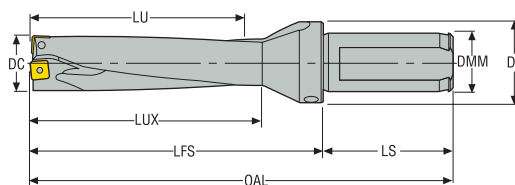

- Codolo ISO 9766, -7
- Adduzione refrigerante interna
- Per le informazioni sugli inserti, vedere pagina(e) 297-303
- Per i parametri di taglio raccomandati, vedere pagina(e) 308, 309
- Per i diametri intermedi, utilizzare MyDesign.

Codice di ordinazione	Codice prodotto	DC	LU	OAL	LUX	LFS	LS	DMM	DF	Inserto	
		mm Inch	mm Inch	mm Inch	mm Inch	mm Inch	mm Inch	mm Inch	mm Inch	mm Inch	Inserto centrale
SD524-17-68-25R7	03080330	17,0 0.669	68,0 2.677	154,0 6.063	73,0 2.874	98,0 3.858	56,0 2.205	25,0 0.984	35,0 1.378	SPGX0502	SCGX050204
SD524-17-70-25R7	03080326	17,5 0.689	70,0 2.756	156,0 6.142	75,0 2.953	100,0 3.937	56,0 2.205	25,0 0.984	35,0 1.378	SPGX0602	SCGX050204
SD524-18-72-25R7	03080333	18,0 0.709	72,0 2.835	158,0 6.220	77,0 3.031	102,0 4.016	56,0 2.205	25,0 0.984	35,0 1.378	SPGX0602	SCGX050204
SD524-18-74-25R7	03080331	18,5 0.728	74,0 2.913	160,0 6.299	79,0 3.110	104,0 4.094	56,0 2.205	25,0 0.984	35,0 1.378	SPGX0602	SCGX050204
SD524-19-76-25R7	03080336	19,0 0.748	76,0 2.992	162,0 6.378	81,0 3.189	106,0 4.173	56,0 2.205	25,0 0.984	35,0 1.378	SPGX0602	SCGX050204
SD524-20-80-25R7	03080340	20,0 0.787	80,0 3.150	166,0 6.535	85,0 3.346	110,0 4.331	56,0 2.205	25,0 0.984	35,0 1.378	SPGX0602	SCGX060204
SD524-21-84-25R7	03080344	21,0 0.827	84,0 3.307	170,0 6.693	89,0 3.504	114,0 4.488	56,0 2.205	25,0 0.984	35,0 1.378	SPGX0602	SCGX060204
SD524-22-88-25R7	03080348	22,0 0.866	88,0 3.465	174,0 6.850	93,0 3.661	118,0 4.646	56,0 2.205	25,0 0.984	35,0 1.378	SPGX0703	SCGX060204
SD524-23-92-25R7	03080351	23,0 0.906	92,0 3.622	178,0 7.008	97,0 3.819	122,0 4.803	56,0 2.205	25,0 0.984	35,0 1.378	SPGX0703	SCGX070308
SD524-24-96-25R7	03080352	24,0 0.945	96,0 3.780	182,0 7.165	101,0 3.976	126,0 4.961	56,0 2.205	25,0 0.984	35,0 1.378	SPGX0703	SCGX070308
SD524-25-100-32R7	03080353	25,0 0.984	100,0 3.937	190,0 7.480	105,0 4.134	130,0 5.118	60,0 2.362	32,0 1.260	42,0 1.654	SPGX0703	SCGX070308
SD524-26-104-32R7	03080354	26,0 1.024	104,0 4.094	194,0 7.638	109,0 4.291	134,0 5.276	60,0 2.362	32,0 1.260	42,0 1.654	SPGX0903	SCGX070308
SD524-27-108-32R7	03080355	27,0 1.063	108,0 4.252	198,0 7.795	113,0 4.449	138,0 5.433	60,0 2.362	32,0 1.260	42,0 1.654	SPGX0903	SCGX070308
SD524-28-112-32R7	03080356	28,0 1.102	112,0 4.409	202,0 7.953	117,0 4.606	142,0 5.591	60,0 2.362	32,0 1.260	42,0 1.654	SPGX0903	SCGX070308
SD524-29-116-32R7	03080357	29,0 1.142	116,0 4.567	206,0 8.110	121,0 4.764	146,0 5.748	60,0 2.362	32,0 1.260	42,0 1.654	SPGX0903	SCGX09T308
SD524-30-120-32R7	03080358	30,0 1.181	120,0 4.724	210,0 8.268	125,0 4.921	150,0 5.906	60,0 2.362	32,0 1.260	42,0 1.654	SPGX0903	SCGX09T308
SD524-31-124-32R7	03080360	31,0 1.220	124,0 4.882	214,0 8.425	129,0 5.079	154,0 6.063	60,0 2.362	32,0 1.260	42,0 1.654	SPGX0903	SCGX09T308
SD524-32-128-40R7	03080361	32,0 1.260	128,0 5.039	226,0 8.898	133,0 5.236	158,0 6.220	68,0 2.677	40,0 1.575	50,0 1.969	SPGX11T3	SCGX09T308
SD524-33-132-40R7	03080362	33,0 1.299	132,0 5.197	230,0 9.055	137,0 5.394	162,0 6.378	68,0 2.677	40,0 1.575	50,0 1.969	SPGX11T3	SCGX09T308
SD524-34-136-40R7	03080363	34,0 1.339	136,0 5.354	234,0 9.213	141,0 5.551	166,0 6.535	68,0 2.677	40,0 1.575	50,0 1.969	SPGX11T3	SCGX09T308
SD524-35-140-40R7	03080364	35,0 1.378	140,0 5.512	238,0 9.370	145,0 5.709	170,0 6.693	68,0 2.677	40,0 1.575	50,0 1.969	SPGX11T3	SCGX11T308
SD524-36-144-40R7	03080365	36,0 1.417	144,0 5.669	242,0 9.528	149,0 5.866	174,0 6.850	68,0 2.677	40,0 1.575	50,0 1.969	SPGX11T3	SCGX11T308

Codice di ordinazione	Codice prodotto	DC	LU	OAL	LUX	LFS	LS	DMM	DF	Inserito	
		mm Inch	mm Inch	mm Inch	mm Inch	mm Inch	mm Inch	mm Inch	mm Inch	mm Inch	Inserito centrale
SD524-37-148-40R7	03080366	37,0 1.457	148,0 5.827	246,0 9.685	153,0 6.024	178,0 7.008	68,0 2.677	40,0 1.575	50,0 1.969	SPGX11T3	SCGX11T308
SD524-38-152-40R7	03080367	38,0 1.496	152,0 5.984	250,0 9.843	157,0 6.181	182,0 7.165	68,0 2.677	40,0 1.575	50,0 1.969	SPGX12T3	SCGX11T308
SD524-39-156-40R7	03080368	39,0 1.535	156,0 6.142	254,0 10.000	161,0 6.339	186,0 7.323	68,0 2.677	40,0 1.575	50,0 1.969	SPGX12T3	SCGX11T308
SD524-40-160-40R7	03080369	40,0 1.575	160,0 6.299	258,0 10.157	165,0 6.496	190,0 7.480	68,0 2.677	40,0 1.575	50,0 1.969	SPGX12T3	SCGX11T308
SD524-41-164-40R7	03080370	41,0 1.614	164,0 6.457	262,0 10.315	169,0 6.654	194,0 7.638	68,0 2.677	40,0 1.575	50,0 1.969	SPGX12T3	SCGX120408
SD524-42-168-40R7	03080371	42,0 1.654	168,0 6.614	266,0 10.472	173,0 6.811	198,0 7.795	68,0 2.677	40,0 1.575	50,0 1.969	SPGX12T3	SCGX120408
SD524-43-172-40R7	03080372	43,0 1.693	172,0 6.772	270,0 10.630	177,0 6.969	202,0 7.953	68,0 2.677	40,0 1.575	50,0 1.969	SPGX12T3	SCGX120408
SD524-44-176-40R7	03080373	44,0 1.732	176,0 6.929	274,0 10.787	181,0 7.126	206,0 8.110	68,0 2.677	40,0 1.575	50,0 1.969	SPGX1504	SCGX120408
SD524-45-180-40R7	03080374	45,0 1.772	180,0 7.087	278,0 10.945	185,0 7.283	210,0 8.268	68,0 2.677	40,0 1.575	50,0 1.969	SPGX1504	SCGX150512
SD524-46-184-40R7	03080375	46,0 1.811	184,0 7.244	282,0 11.102	189,0 7.441	214,0 8.425	68,0 2.677	40,0 1.575	50,0 1.969	SPGX1504	SCGX150512
SD524-47-188-40R7	03080376	47,0 1.850	188,0 7.402	286,0 11.260	193,0 7.598	218,0 8.583	68,0 2.677	40,0 1.575	50,0 1.969	SPGX1504	SCGX150512
SD524-48-192-40R7	03080377	48,0 1.890	192,0 7.559	290,0 11.417	197,0 7.756	222,0 8.740	68,0 2.677	40,0 1.575	59,35 2.337	SPGX1504	SCGX150512
SD524-49-196-40R7	03080378	49,0 1.929	196,0 7.717	294,0 11.575	201,0 7.913	226,0 8.898	68,0 2.677	40,0 1.575	59,35 2.337	SPGX1504	SCGX150512
SD524-50-200-40R7	03080379	50,0 1.969	200,0 7.874	298,0 11.732	205,0 8.071	230,0 9.055	68,0 2.677	40,0 1.575	59,35 2.337	SPGX1504	SCGX150512
SD524-51-204-40R7	03080380	51,0 2.008	204,0 8.031	302,0 11.890	209,0 8.228	234,0 9.213	68,0 2.677	40,0 1.575	59,35 2.337	SPGX1504	SCGX150512
SD524-52-208-40R7	03080381	52,0 2.047	208,0 8.189	306,0 12.047	213,0 8.386	238,0 9.370	68,0 2.677	40,0 1.575	59,35 2.337	SPGX1904	SCGX150512
SD524-53-212-40R7	03080382	53,0 2.087	212,0 8.346	310,0 12.205	217,0 8.543	242,0 9.528	68,0 2.677	40,0 1.575	59,35 2.337	SPGX1904	SCGX150512
SD524-54-216-40R7	03080383	54,0 2.126	216,0 8.504	314,0 12.362	221,0 8.701	246,0 9.685	68,0 2.677	40,0 1.575	59,35 2.337	SPGX1904	SCGX150512
SD524-55-220-40R7	03080384	55,0 2.165	220,0 8.661	318,0 12.520	225,0 8.858	250,0 9.843	68,0 2.677	40,0 1.575	59,35 2.337	SPGX1904	SCGX150512
SD524-56-224-40R7	03080385	56,0 2.205	224,0 8.819	322,0 12.677	229,0 9.016	254,0 10.000	68,0 2.677	40,0 1.575	59,35 2.337	SPGX1904	SCGX150512
SD524-57-228-40R7	03080386	57,0 2.244	228,0 8.976	326,0 12.835	233,0 9.173	258,0 10.157	68,0 2.677	40,0 1.575	59,35 2.337	SPGX1904	SCGX150512
SD524-58-232-40R7	03080387	58,0 2.283	232,0 9.134	330,0 12.992	237,0 9.331	262,0 10.315	68,0 2.677	40,0 1.575	63,0 2.480	SPGX1904	SCGX150512
SD524-59-236-40R7	03080388	59,0 2.323	236,0 9.291	334,0 13.150	241,0 9.488	266,0 10.472	68,0 2.677	40,0 1.575	63,0 2.480	SPGX1904	SCGX150512

Introduzione

Foratura

Alesatura

Barenatura

Allegato

Parti di ricambio, comprese nella fornitura

Per punta diametro (mm)	Vite di bloccaggio inserto		Chiave per vite inserto
	Inserto centrale	Inserto periferico	
15,00-17,45	C02245-T07P	C02245-T07P	T07P-2
17,46-19,49	C02205-T07P	C02245-T07P	T07P-2
19,50-21,24	C02205-T07P	C02205-T07P	T07P-2
21,25-22,49	C02506-T08P	C02506-T08P	T08P-2
22,50-25,49	C02507-T08P	C03007-T08P	T08P-2
25,50-28,49	C03007-T09P	C03007-T09P	T09P-2
28,50-31,49	C03007-T09P	C03009-T09P	T09P-2
31,50-40,49	C03508-T15P	C03508-T15P	T15P-2D
40,50-43,24	C03508-T15P	C05012-T15P	T15P-2D
43,25-59,00	C04011-T15P	C05012-T15P	T15P-2D

Accessori

Per punta diametro (mm)	Chiave dinamometrica*	Bit sostituibile	Valore di coppia
15,00-17,45	T00-07P09	T00-07P	0,9 Nm
17,46-19,49	T00-07P09	T00-07P	0,9 Nm
19,50-21,24	T00-07P09	T00-07P	0,9 Nm
21,25-22,49	T00-08P12	T00-08P	1,2 Nm
22,50-25,49	T00-08P12	T00-08P	1,2 Nm
25,50-28,49	T00-09P20	T00-09P	2,0 Nm
28,50-31,49	T00-09P20	T00-09P	2,0 Nm
31,50-40,49	T00-15P30	T00-15P	3,0 Nm
40,50-43,24	T00-15P30	T00-15P	3,0 Nm
43,25-59,00	T00-15P30	T00-15P	3,0 Nm

*Lama inclusa.

Introduzione

Foratura

Alesatura

Barenatura

Allegato

SD524

Profondità di foratura ~ 4 x D – Pollici

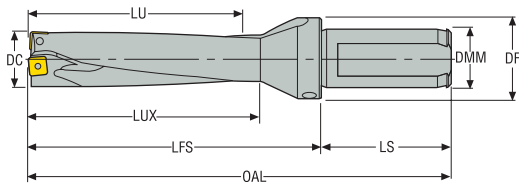

- Codolo ISO 9766, R7
- Adduzione refrigerante interna
- Per le informazioni sugli inserti, vedere pagina(e) 297-303
- Per i parametri di taglio raccomandati, vedere pagina(e) 308, 309
- Per i diametri intermedi, utilizzare MyDesign.

Codice di ordinazione	Codice prodotto	DC	LU	OAL	LUX	LFS	LS	DMM	DF	Inserto	
		<i>Inch</i>	<i>Inch</i>	<i>Inch</i>	<i>Inch</i>	<i>Inch</i>	<i>Inch</i>	<i>Inch</i>	<i>Inch</i>	<i>Inch</i>	Inserto centrale
SD524-0594-238-1000R7	03080280	0.594	2.380	5.811	2.577	3.561	2.250	1.000	1.378	SPGX0502	SCGX050204
SD524-0625-250-1000R7	03080281	0.625	2.500	5.931	2.697	3.681	2.250	1.000	1.378	SPGX0502	SCGX050204
SD524-0656-262-1000R7	03080283	0.656	2.620	6.051	2.817	3.801	2.250	1.000	1.378	SPGX0502	SCGX050204
SD524-0687-275-1000R7	03080285	0.687	2.750	6.181	2.947	3.931	2.250	1.000	1.378	SPGX0502	SCGX050204
SD524-0709-284-1000R7	03080286	0.709	2.840	6.271	3.037	4.021	2.250	1.000	1.378	SPGX0602	SCGX050204
SD524-0750-300-1000R7	03080288	0.750	3.000	6.431	3.197	4.181	2.250	1.000	1.378	SPGX0602	SCGX050204
SD524-0766-306-1000R7	03080289	0.766	3.060	6.491	3.257	4.241	2.250	1.000	1.378	SPGX0602	SCGX050204
SD524-0787-315-1000R7	03080290	0.787	3.150	6.581	3.347	4.331	2.250	1.000	1.378	SPGX0602	SCGX060204
SD524-0812-325-1000R7	03080292	0.812	3.250	6.681	3.447	4.431	2.250	1.000	1.378	SPGX0602	SCGX060204
SD524-0827-331-1000R7	03080294	0.827	3.310	6.741	3.507	4.491	2.250	1.000	1.378	SPGX0602	SCGX060204
SD524-0875-350-1000R7	03080295	0.875	3.500	6.931	3.697	4.681	2.250	1.000	1.378	SPGX0703	SCGX060204
SD524-0906-362-1000R7	03080297	0.906	3.620	7.051	3.817	4.801	2.250	1.000	1.378	SPGX0703	SCGX070308
SD524-0922-369-1000R7	03080298	0.922	3.690	7.121	3.887	4.871	2.250	1.000	1.378	SPGX0703	SCGX070308
SD524-0937-375-1000R7	03080299	0.937	3.750	7.181	3.947	4.931	2.250	1.000	1.378	SPGX0703	SCGX070308
SD524-0984-394-1250R7	03080301	0.984	3.940	7.496	4.137	5.121	2.375	1.250	1.654	SPGX0703	SCGX070308
SD524-1000-400-1250R7	03080302	1.000	4.000	7.556	4.197	5.181	2.375	1.250	1.654	SPGX0703	SCGX070308
SD524-1032-413-1250R7	03080304	1.032	4.130	7.686	4.327	5.311	2.375	1.250	1.654	SPGX0903	SCGX070308
SD524-1062-425-1250R7	03080305	1.062	4.250	7.806	4.447	5.431	2.375	1.250	1.654	SPGX0903	SCGX070308
SD524-1109-443-1250R7	03080307	1.109	4.430	7.986	4.627	5.611	2.375	1.250	1.654	SPGX0903	SCGX070308
SD524-1125-450-1250R7	03080308	1.125	4.500	8.056	4.697	5.681	2.375	1.250	1.654	SPGX0903	SCGX09T308
SD524-1172-469-1250R7	03080310	1.172	4.690	8.246	4.887	5.871	2.375	1.250	1.654	SPGX0903	SCGX09T308
SD524-1187-475-1250R7	03080311	1.187	4.750	8.306	4.947	5.931	2.375	1.250	1.654	SPGX0903	SCGX09T308
SD524-1250-500-1500R7	03080314	1.250	5.000	8.806	5.197	6.181	2.625	1.500	1.969	SPGX11T3	SCGX09T308
SD524-1312-525-1500R7	03080315	1.312	5.250	9.056	5.447	6.431	2.625	1.500	1.969	SPGX11T3	SCGX09T308
SD524-1344-538-1500R7	03080317	1.344	5.380	9.186	5.577	6.561	2.625	1.500	1.969	SPGX11T3	SCGX09T308
SD524-1375-550-1500R7	03080318	1.375	5.500	9.306	5.697	6.681	2.625	1.500	1.969	SPGX11T3	SCGX11T308
SD524-1437-575-1500R7	03080320	1.437	5.750	9.556	5.947	6.931	2.625	1.500	1.969	SPGX11T3	SCGX11T308
SD524-1500-600-1500R7	03080322	1.500	6.000	9.806	6.197	7.181	2.625	1.500	1.969	SPGX12T3	SCGX11T308
SD524-1562-625-1500R7	03080323	1.562	6.250	10.056	6.447	7.431	2.625	1.500	1.969	SPGX12T3	SCGX11T308
SD524-1625-650-1500R7	03080324	1.625	6.500	10.306	6.697	7.681	2.625	1.500	1.969	SPGX12T3	SCGX120408
SD524-1687-675-1500R7	03080325	1.687	6.750	10.556	6.947	7.931	2.625	1.500	1.969	SPGX12T3	SCGX120408
SD524-1750-700-1500R7	03080328	1.750	7.000	10.806	7.197	8.181	2.625	1.500	1.969	SPGX1504	SCGX120408
SD524-1812-725-1500R7	03080332	1.812	7.250	11.056	7.447	8.431	2.625	1.500	1.969	SPGX1504	SCGX150512
SD524-1875-750-1500R7	03080334	1.875	7.500	11.306	7.697	8.681	2.625	1.500	1.969	SPGX1504	SCGX150512
SD524-1937-775-1500R7	03080335	1.937	7.750	11.556	7.947	8.931	2.625	1.500	2.337	SPGX1504	SCGX150512
SD524-2000-800-1500R7	03080337	2.000	8.000	11.806	8.197	9.181	2.625	1.500	2.337	SPGX1504	SCGX150512

Introduzione

Foratura

Alesatura

Barenatura



Allegato

Introduzione

Codice di ordinazione	Codice prodotto	DC	LU	OAL	LUX	LFS	LS	DMM	DF	Inserto	
		<i>Inch</i>	<i>Inch</i>	<i>Inch</i>	<i>Inch</i>	<i>Inch</i>	<i>Inch</i>	<i>Inch</i>	<i>Inch</i>	<i>Inch</i>	Inserto centrale
SD524-2062-825-1500R7	03080339	2.062	8.250	12.056	8.447	9.431	2.625	1.500	2.337	SPGX1904	SCGX150512
SD524-2125-850-1500R7	03080342	2.125	8.500	12.306	8.697	9.681	2.625	1.500	2.337	SPGX1904	SCGX150512
SD524-2250-900-1500R7	03080346	2.250	9.000	12.806	9.197	10.181	2.625	1.500	2.337	SPGX1904	SCGX150512
SD524-2375-950-1500R7	03080349	2.375	9.500	13.306	9.697	10.681	2.625	1.500	2.480	SPGX1904	SCGX150512

Parti di ricambio, comprese nella fornitura

Foratura

Per punta diametro (pollici)	Vite di bloccaggio inserto centrale	Vite di bloccaggio inserto periferico	Chiave
			
0.594-0.687	C02245-T07P	C02245-T07P	T07P-2
0.709-0.766	C02205-T07P	C02245-T07P	T07P-2
0.787-0.827	C02205-T07P	C02205-T07P	T07P-2
0.875-0.905	C02506-T08P	C02506-T08P	T08P-2
0.906-1.000	C02507-T08P	C03007-T08P	T08P-2
1.032-1.109	C03007-T09P	C03007-T09P	T09P-2
1.125-1.187	C03007-T09P	C03009-T09P	T09P-2
1.250-1.562	C03508-T15P	C03508-T15P	T15P-2D
1.625-1.687	C03508-T15P	C05012-T15P	T15P-2D
1.750-2.375	C04011-T15P	C05012-T15P	T15P-2D

Accessori

Alesatura

Per punta diametro (pollici)	Chiave dinamometrica
	
0.594-0.687	T00-07P09
0.709-0.766	T00-07P09
0.787-0.827	T00-07P09
0.875-0.905	T00-08P12
0.906-1.000	T00-08P12
1.032-1.109	T00-09P20
1.125-1.187	T00-09P20
1.250-1.562	T00-15P30
1.625-1.687	T00-15P30
1.750-2.375	T00-15P35

Barenatura

Chiave dinamometrica con lama inclusa.

Allegato

SD524

Profondità di foratura ~ 4 x D – Pollici

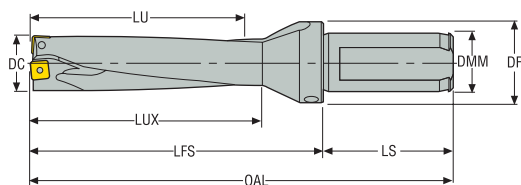

- Codolo ISO 9766, R7-C
- Adduzione refrigerante interna
- Per le informazioni sugli inserti, vedere pagina(e) 297-303
- Per i parametri di taglio raccomandati, vedere pagina(e) 308, 309
- Per i diametri intermedi, utilizzare MyDesign.
- Per applicazioni statiche

Codice di ordinazione	Codice prodotto	DC	LU	OAL	LUX	LFS	LS	DMM	DF	Inserto	
										Inserto centrale	Inserto periferico
SD524-0625-250-1000R7-C	03080282	0.625	2.500	6.628	2.697	3.878	2.750	1.000	1.378	SPGX0502	SCGX050204
SD524-0687-275-1000R7-C	03080284	0.687	2.750	6.878	2.947	4.128	2.750	1.000	1.378	SCGX0502	SCGX050204
SD524-0750-300-1000R7-C	03080287	0.750	3.000	7.128	3.197	4.378	2.750	1.000	1.378	SPGX0602	SCGX050204
SD524-0812-325-1000R7-C	03080293	0.812	3.250	7.378	3.447	4.628	2.750	1.000	1.378	SPGX0602	SCGX060204
SD524-0875-350-1000R7-C	03080296	0.875	3.500	7.628	3.697	4.878	2.750	1.000	1.378	SPGX0703	SCGX060204
SD524-0937-375-1000R7-C	03080300	0.937	3.750	7.878	3.947	5.128	2.750	1.000	1.378	SPGX0703	SCGX070308
SD524-1000-400-1250R7-C	03080303	1.000	4.000	8.128	4.197	5.378	2.750	1.250	1.654	SPGX0703	SCGX070308
SD524-1062-425-1250R7-C	03080306	1.062	4.250	8.378	4.447	5.628	2.750	1.250	1.654	SPGX0903	SCGX070308
SD524-1125-450-1250R7-C	03080309	1.125	4.500	8.628	4.697	5.878	2.750	1.250	1.654	SPGX0903	SCGX09T308
SD524-1187-475-1250R7-C	03080312	1.187	4.750	8.878	4.947	6.128	2.750	1.250	1.654	SPGX0903	SCGX09T308
SD524-1250-500-1500R7-C	03080313	1.250	5.000	9.128	5.197	6.378	2.750	1.500	1.969	SPGX11T3	SCGX09T308
SD524-1312-525-1500R7-C	03080316	1.312	5.250	9.378	5.447	6.628	2.750	1.500	1.969	SPGX11T3	SCGX09T308
SD524-1375-550-1500R7-C	03080319	1.375	5.500	9.628	5.697	6.878	2.750	1.500	1.969	SPGX11T3	SCGX11T308
SD524-1500-600-1500R7-C	03080321	1.500	6.000	10.128	6.197	7.378	2.750	1.500	1.969	SPGX12T3	SCGX11T308
SD524-1750-700-1500R7-C	03080329	1.750	7.000	11.128	7.197	8.378	2.750	1.500	1.969	SPGX1504	SCGX120408
SD524-2000-800-1500R7-C	03080338	2.000	8.000	12.128	8.197	9.378	2.750	1.500	2.337	SPGX1504	SCGX150512
SD524-2125-850-1500R7-C	03080343	2.125	8.500	12.628	8.697	9.878	2.750	1.500	2.337	SPGX1904	SCGX150512
SD524-2250-900-1500R7-C	03080347	2.250	9.000	13.128	9.197	10.378	2.750	1.500	2.337	SPGX1904	SCGX150512
SD524-2375-950-1500R7-C	03080350	2.375	9.500	13.628	9.697	10.878	2.750	1.500	2.480	SPGX1904	SCGX150512

Parti di ricambio, comprese nella fornitura

Per punta diametro (pollici)	Vite di bloccaggio inserto centrale	Vite di bloccaggio inserto periferico	Chiave	Grano
0.625-0.687	 C02245-T07P	 C02245-T07P	 T07P-2	 R1/4
0.750	C02205-T07P	C02245-T07P	T07P-2	R1/4
0.812	C02205-T07P	C02205-T07P	T07P-2	R1/4
0.875	C02506-T08P	C02506-T08P	T08P-2	R1/4
0.937-1.000	C02507-T08P	C03007-T08P	T08P-2	R1/4
1.062	C03007-T09P	C03007-T09P	T09P-2	R1/4
1.125-1.187	C03007-T09P	C03009-T09P	T09P-2	R1/4
1.250-1.375	C03508-T15P	C03508-T15P	T15P-2D	R1/4
1.750-2.375	C04011-T15P	C05012-T15P	T15P-2D	R1/4

Introduzione



Foratura

Alesatura

Barenatura

Allegato

Accessori

Per punta diametro (pollici)	Adattatore	Chiave dinamometrica
		
0.625-0.687	1310	T00-07P09
0.750	1310	T00-07P09
0.812	1310	T00-07P09
0.875	1310	T00-08P12
0.937-1.000	1310	T00-08P12
1.062	1310	T00-09P20
1.125-1.187	1310	T00-09P20
1.250-1.375	1310	T00-15P30
1.750-2.375	1310	T00-15P35

Introduzione

Foratura

Alesatura

Barenatura

Allegato

SD524

Profondità di foratura ~ 4 x D – Misure metriche/Pollici

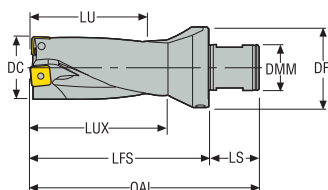

- Codolo compatibile ABS 50, -2
- Adduzione refrigerante interna
- Per le informazioni sugli inserti, vedere pagina(e) 297-303
- Per i parametri di taglio raccomandati, vedere pagina(e) 308, 309
- Per i diametri intermedi, utilizzare MyDesign.

Codice di ordinazione	Codice prodotto	DC	LU	OAL	LUX	LFS	LS	DMM	DF	Inserto	
										mm Inch	mm Inch
SD524-17-68-50R2	03080208	17,0 0.669	68,0 2.677	129,0 5.079	73,0 2.874	98,0 3.858	31,0 1.220	28,0 1.102	50,0 1.969	SPGX0502	SCGX050204
SD524-17.5-70-50R2	03080327	17,5 0.689	70,0 2.756	131,0 5.157	75,0 2.953	100,0 3.937	31,0 1.220	28,0 1.102	50,0 1.969	SPGX0602	SCGX050204
SD524-18-72-50R2	03080209	18,0 0.709	72,0 2.835	133,0 5.236	77,0 3.031	102,0 4.016	31,0 1.220	28,0 1.102	50,0 1.969	SPGX0602	SCGX050204
SD524-18.5-74-50R2	03080210	18,5 0.728	74,0 2.913	135,0 5.315	79,0 3.110	104,0 4.094	31,0 1.220	28,0 1.102	50,0 1.969	SPGX0602	SCGX050204
SD524-19-76-50R2	03080422	19,0 0.748	76,0 2.992	137,0 5.394	81,0 3.189	106,0 4.173	31,0 1.220	28,0 1.102	50,0 1.969	SPGX0602	SCGX050204
SD524-20-80-50R2	03080341	20,0 0.787	80,0 3.150	141,0 5.551	85,0 3.346	110,0 4.331	31,0 1.220	28,0 1.102	50,0 1.969	SPGX0602	SCGX060204
SD524-20.62-83-50R2	03080215	20,62 0.812	83,0 3.268	144,0 5.669	88,0 3.465	113,0 4.449	31,0 1.220	28,0 1.102	50,0 1.969	SPGX0602	SCGX060204
SD524-21-84-50R2	03080345	21,0 0.827	84,0 3.307	145,0 5.709	89,0 3.504	114,0 4.488	31,0 1.220	28,0 1.102	50,0 1.969	SPGX0602	SCGX060204
SD524-22-88-50R2	03080193	22,0 0.866	88,0 3.465	149,0 5.866	93,0 3.661	118,0 4.646	31,0 1.220	28,0 1.102	50,0 1.969	SPGX0703	SCGX060204
SD524-22.23-89-50R2	03080216	22,23 0.875	89,0 3.504	150,0 5.906	94,0 3.701	119,0 4.685	31,0 1.220	28,0 1.102	50,0 1.969	SPGX0703	SCGX060204
SD524-23-92-50R2	03080194	23,0 0.906	92,0 3.622	153,0 6.024	97,0 3.819	122,0 4.803	31,0 1.220	28,0 1.102	50,0 1.969	SPGX0703	SCGX070308
SD524-24-96-50R2	03080195	24,0 0.945	96,0 3.780	157,0 6.181	101,0 3.976	126,0 4.961	31,0 1.220	28,0 1.102	50,0 1.969	SPGX0703	SCGX070308
SD524-25-100-50R2	03080196	25,0 0.984	100,0 3.937	161,0 6.339	105,0 4.134	130,0 5.118	31,0 1.220	28,0 1.102	50,0 1.969	SPGX0703	SCGX070308
SD524-25.4-102-50R2	03080217	25,4 1.000	102,0 4.016	163,0 6.417	107,0 4.213	132,0 5.197	31,0 1.220	28,0 1.102	50,0 1.969	SPGX0703	SCGX070308
SD524-26-104-50R2	03080423	26,0 1.024	104,0 4.094	165,0 6.496	109,0 4.291	134,0 5.276	31,0 1.220	28,0 1.102	50,0 1.969	SPGX0903	SCGX070308
SD524-27-108-50R2	03080197	27,0 1.063	108,0 4.252	169,0 6.654	113,0 4.449	138,0 5.433	31,0 1.220	28,0 1.102	50,0 1.969	SPGX0903	SCGX070308
SD524-28-112-50R2	03080424	28,0 1.102	112,0 4.409	173,0 6.811	117,0 4.606	142,0 5.591	31,0 1.220	28,0 1.102	50,0 1.969	SPGX0903	SCGX070308
SD524-28.59-115-50R2	03080218	28,59 1.126	115,0 4.528	176,0 6.929	120,0 4.724	145,0 5.709	31,0 1.220	28,0 1.102	50,0 1.969	SPGX0903	SCGX070308
SD524-29-116-50R2	03080198	29,0 1.142	116,0 4.567	177,0 6.969	121,0 4.764	146,0 5.748	31,0 1.220	28,0 1.102	50,0 1.969	SPGX0903	SCGX09T308
SD524-30-120-50R2	03080199	30,0 1.181	120,0 4.724	181,0 7.126	125,0 4.921	150,0 5.906	31,0 1.220	28,0 1.102	50,0 1.969	SPGX0903	SCGX09T308
SD524-31-124-50R2	03080200	31,0 1.220	124,0 4.882	185,0 7.283	129,0 5.079	154,0 6.063	31,0 1.220	28,0 1.102	50,0 1.969	SPGX0903	SCGX09T308
SD524-31.75-127-50R2	03080359	31,75 1.250	127,0 5.000	188,0 7.402	132,0 5.197	157,0 6.181	31,0 1.220	50,0 1.969	50,0 1.969	SPGX11T3	SCGX09T308

Introduzione

Foratura



Alesatura

Barenatura



Allegato

Codice di ordinazione	Codice prodotto	DC	LU	OAL	LUX	LFS	LS	DMM	DF	Inserto	
		mm Inch	mm Inch	mm Inch	mm Inch	mm Inch	mm Inch	mm Inch	mm Inch	mm Inch	Inserto centrale
SD524-32-128-50R2	03080425	32,0 1.260	128,0 5.039	189,0 7.441	133,0 5.236	158,0 6.220	31,0 1.220	28,0 1.102	50,0 1.969	SPGX11T3	SCGX09T308
SD524-33-132-50R2	03080201	33,0 1.299	132,0 5.197	193,0 7.598	137,0 5.394	162,0 6.378	31,0 1.220	28,0 1.102	50,0 1.969	SPGX11T3	SCGX09T308
SD524-34-136-50R2	03080207	34,0 1.339	136,0 5.354	197,0 7.756	141,0 5.551	166,0 6.535	31,0 1.220	28,0 1.102	50,0 1.969	SPGX11T3	SCGX09T308
SD524-35-140-50R2	03080202	35,0 1.378	140,0 5.512	201,0 7.913	145,0 5.709	170,0 6.693	31,0 1.220	28,0 1.102	50,0 1.969	SPGX11T3	SCGX11T308
SD524-36-144-50R2	03080203	36,0 1.417	144,0 5.669	205,0 8.071	149,0 5.866	174,0 6.850	31,0 1.220	28,0 1.102	50,0 1.969	SPGX11T3	SCGX11T308
SD524-37-148-50R2	03080204	37,0 1.457	148,0 5.827	209,0 8.228	153,0 6.024	178,0 7.008	31,0 1.220	28,0 1.102	50,0 1.969	SPGX11T3	SCGX11T308
SD524-38-152-50R2	03080426	38,0 1.496	152,0 5.984	213,0 8.386	157,0 6.181	182,0 7.165	31,0 1.220	28,0 1.102	50,0 1.969	SPGX12T3	SCGX11T308
SD524-39-156-50R2	03080205	39,0 1.535	156,0 6.142	217,0 8.543	161,0 6.339	186,0 7.323	31,0 1.220	28,0 1.102	50,0 1.969	SPGX12T3	SCGX11T308
SD524-40-160-50R2	03080206	40,0 1.575	160,0 6.299	221,0 8.701	165,0 6.496	190,0 7.480	31,0 1.220	28,0 1.102	50,0 1.969	SPGX12T3	SCGX11T308

Parti di ricambio, comprese nella fornitura

Per punta diametro (mm)	Vite di bloccaggio inserto		Chiave per vite inserto
			
	Inserto centrale	Inserto periferico	
15,00-17,45	C02245-T07P	C02245-T07P	T07P-2
17,46-19,49	C02205-T07P	C02245-T07P	T07P-2
19,50-21,24	C02205-T07P	C02205-T07P	T07P-2
21,25-22,49	C02506-T08P	C02506-T08P	T08P-2
22,50-25,49	C02507-T08P	C03007-T08P	T08P-2
25,50-28,49	C03007-T09P	C03007-T09P	T09P-2
28,50-31,49	C03007-T09P	C03009-T09P	T09P-2
31,50-40,49	C03508-T15P	C03508-T15P	T15P-2D
40,50-43,24	C03508-T15P	C05012-T15P	T15P-2D
43,25-59,00	C04011-T15P	C05012-T15P	T15P-2D

Accessori

Per punta diametro (mm)	Chiave dinamometrica*	Bit sostituibile	Valore di coppia
			
15,00-17,45	T00-07P09	T00-07P	0,9 Nm
17,46-19,49	T00-07P09	T00-07P	0,9 Nm
19,50-21,24	T00-07P09	T00-07P	0,9 Nm
21,25-22,49	T00-08P12	T00-08P	1,2 Nm
22,50-25,49	T00-08P12	T00-08P	1,2 Nm
25,50-28,49	T00-09P20	T00-09P	2,0 Nm
28,50-31,49	T00-09P20	T00-09P	2,0 Nm
31,50-40,49	T00-15P30	T00-15P	3,0 Nm
40,50-43,24	T00-15P30	T00-15P	3,0 Nm
43,25-59,00	T00-15P30	T00-15P	3,0 Nm

*Lama inclusa.

SD524

Profondità di foratura ~ 4 x D – Misure metriche/Pollici

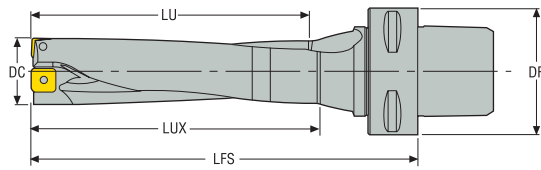

- Codolo C4 Seco-Capto™
- Adduzione refrigerante interna
- Per le informazioni sugli inserti, vedere pagina(e) 297-303
- Per i parametri di taglio raccomandati, vedere pagina(e) 308, 309
- Per i diametri intermedi, utilizzare MyDesign.

Codice di ordinazione	Codice prodotto	DC	LU	LUX	LFS	DF	Inserto	
		mm <i>Inch</i>	mm <i>Inch</i>	mm <i>Inch</i>	mm <i>Inch</i>	mm <i>Inch</i>	Inserto centrale	Inserto periferico
SD524-17-68-C4	03080219	17,0 <i>0.669</i>	68,0 <i>2.677</i>	73,0 <i>2.874</i>	106,0 <i>4.173</i>	40,0 <i>1.575</i>	SPGX0502	SCGX050204
SD524-17.5-70-C4	03080220	17,5 <i>0.689</i>	70,0 <i>2.756</i>	75,0 <i>2.953</i>	109,0 <i>4.291</i>	40,0 <i>1.575</i>	SPGX0602	SCGX050204
SD524-18-72-C4	03080221	18,0 <i>0.709</i>	72,0 <i>2.835</i>	77,0 <i>3.031</i>	111,0 <i>4.370</i>	40,0 <i>1.575</i>	SPGX0602	SCGX050204
SD524-18.5-74-C4	03080222	18,5 <i>0.728</i>	74,0 <i>2.913</i>	79,0 <i>3.110</i>	113,0 <i>4.449</i>	40,0 <i>1.575</i>	SPGX0602	SCGX050204
SD524-19-76-C4	03080223	19,0 <i>0.748</i>	76,0 <i>2.992</i>	81,0 <i>3.189</i>	115,0 <i>4.528</i>	40,0 <i>1.575</i>	SPGX0602	SCGX050204
SD524-20-80-C4	03080224	20,0 <i>0.787</i>	80,0 <i>3.150</i>	85,0 <i>3.346</i>	121,0 <i>4.764</i>	40,0 <i>1.575</i>	SPGX0602	SCGX060204
SD524-20.62-83-C4	03080413	20,62 <i>0.812</i>	83,0 <i>3.268</i>	88,0 <i>3.465</i>	124,0 <i>4.882</i>	40,0 <i>1.575</i>	SPGX0602	SCGX060204
SD524-21-84-C4	03080225	21,0 <i>0.827</i>	84,0 <i>3.307</i>	89,0 <i>3.504</i>	125,0 <i>4.921</i>	40,0 <i>1.575</i>	SPGX0602	SCGX060204
SD524-22-88-C4	03080226	22,0 <i>0.866</i>	88,0 <i>3.465</i>	93,0 <i>3.661</i>	129,0 <i>5.079</i>	40,0 <i>1.575</i>	SPGX0703	SCGX060204
SD524-22.23-89-C4	03080414	22,23 <i>0.875</i>	89,0 <i>3.504</i>	94,0 <i>3.701</i>	130,0 <i>5.118</i>	40,0 <i>1.575</i>	SPGX0703	SCGX060204
SD524-23-92-C4	03080227	23,0 <i>0.906</i>	92,0 <i>3.622</i>	97,0 <i>3.819</i>	134,0 <i>5.276</i>	40,0 <i>1.575</i>	SPGX0703	SCGX070308
SD524-24-96-C4	03080228	24,0 <i>0.945</i>	96,0 <i>3.780</i>	101,0 <i>3.976</i>	139,0 <i>5.472</i>	40,0 <i>1.575</i>	SPGX0703	SCGX070308
SD524-25-100-C4	03080229	25,0 <i>0.984</i>	100,0 <i>3.937</i>	105,0 <i>4.134</i>	144,0 <i>5.669</i>	40,0 <i>1.575</i>	SPGX0703	SCGX070308
SD524-25.4-102-C4	03080415	25,4 <i>1.000</i>	102,0 <i>4.016</i>	107,0 <i>4.213</i>	146,0 <i>5.748</i>	40,0 <i>1.575</i>	SPGX0703	SCGX070308
SD524-26-104-C4	03080230	26,0 <i>1.024</i>	104,0 <i>4.094</i>	109,0 <i>4.291</i>	148,0 <i>5.827</i>	40,0 <i>1.575</i>	SPGX0903	SCGX070308
SD524-27-108-C4	03080231	27,0 <i>1.063</i>	108,0 <i>4.252</i>	113,0 <i>4.449</i>	152,0 <i>5.984</i>	40,0 <i>1.575</i>	SPGX0903	SCGX070308
SD524-28-112-C4	03080232	28,0 <i>1.102</i>	112,0 <i>4.409</i>	117,0 <i>4.606</i>	157,0 <i>6.181</i>	40,0 <i>1.575</i>	SPGX0903	SCGX070308
SD524-28.59-115-C4	03080416	28,59 <i>1.126</i>	115,0 <i>4.528</i>	120,0 <i>4.724</i>	160,0 <i>6.299</i>	40,0 <i>1.575</i>	SPGX0903	SCGX070308
SD524-29-116-C4	03080233	29,0 <i>1.142</i>	116,0 <i>4.567</i>	121,0 <i>4.764</i>	161,0 <i>6.339</i>	40,0 <i>1.575</i>	SPGX0903	SCGX09T308
SD524-30-120-C4	03080234	30,0 <i>1.181</i>	120,0 <i>4.724</i>	125,0 <i>4.921</i>	165,0 <i>6.496</i>	40,0 <i>1.575</i>	SPGX0903	SCGX09T308

Introduzione

Foratura

Alesatura

Barenatura

Allegato

Parti di ricambio, comprese nella fornitura

Per punta diametro (mm)	Vite di bloccaggio inserto		Chiave per vite inserto
	Inserto centrale	Inserto periferico	
15,00-17,45	C02245-T07P	C02245-T07P	T07P-2
17,46-19,49	C02205-T07P	C02245-T07P	T07P-2
19,50-21,24	C02205-T07P	C02205-T07P	T07P-2
21,25-22,49	C02506-T08P	C02506-T08P	T08P-2
22,50-25,49	C02507-T08P	C03007-T08P	T08P-2
25,50-28,49	C03007-T09P	C03007-T09P	T09P-2
28,50-31,49	C03007-T09P	C03009-T09P	T09P-2
31,50-40,49	C03508-T15P	C03508-T15P	T15P-2D
40,50-43,24	C03508-T15P	C05012-T15P	T15P-2D
43,25-59,00	C04011-T15P	C05012-T15P	T15P-2D

Accessori

Per punta diametro (mm)	Chiave dinamometrica*	Bit sostituibile	Valore di coppia
15,00-17,45	T00-07P09	T00-07P	0,9 Nm
17,46-19,49	T00-07P09	T00-07P	0,9 Nm
19,50-21,24	T00-07P09	T00-07P	0,9 Nm
21,25-22,49	T00-08P12	T00-08P	1,2 Nm
22,50-25,49	T00-08P12	T00-08P	1,2 Nm
25,50-28,49	T00-09P20	T00-09P	2,0 Nm
28,50-31,49	T00-09P20	T00-09P	2,0 Nm
31,50-40,49	T00-15P30	T00-15P	3,0 Nm
40,50-43,24	T00-15P30	T00-15P	3,0 Nm
43,25-59,00	T00-15P30	T00-15P	3,0 Nm

*Lama inclusa.

Introduzione

Foratura

Alesatura

Barenatura

Allegato

SD524

Profondità di foratura ~ 4 x D – Misure metriche/Pollici

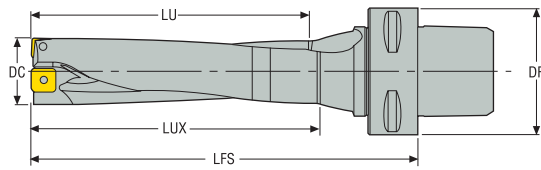

- Codolo C5 Seco-Capto™
- Adduzione refrigerante interna
- Per le informazioni sugli inserti, vedere pagina(e) 297-303
- Per i parametri di taglio raccomandati, vedere pagina(e) 308, 309
- Per i diametri intermedi, utilizzare MyDesign.

Codice di ordinazione	Codice prodotto	DC	LU	LUX	LFS	DF	Inserto	
		mm Inch	mm Inch	mm Inch	mm Inch	mm Inch	Inserto centrale	Inserto periferico
SD524-17-68-C5	03080235	17,0 0.669	68,0 2.677	73,0 2.874	106,0 4.173	50,0 1.969	SPGX0502	SCGX050204
SD524-17.5-70-C5	03080237	17,5 0.689	70,0 2.756	75,0 2.953	109,0 4.291	50,0 1.969	SPGX0602	SCGX050204
SD524-18-72-C5	03080238	18,0 0.709	72,0 2.835	77,0 3.031	111,0 4.370	50,0 1.969	SPGX0602	SCGX050204
SD524-18.5-74-C5	03080239	18,5 0.728	74,0 2.913	79,0 3.110	113,0 4.449	50,0 1.969	SPGX0602	SCGX050204
SD524-19-76-C5	03080240	19,0 0.748	76,0 2.992	81,0 3.189	115,0 4.528	50,0 1.969	SPGX0602	SCGX050204
SD524-20-80-C5	03080241	20,0 0.787	80,0 3.150	85,0 3.346	121,0 4.764	50,0 1.969	SPGX0602	SCGX060204
SD524-20.62-83-C5	03080408	20,62 0.812	83,0 3.268	88,0 3.465	124,0 4.882	50,0 1.969	SPGX0602	SCGX060204
SD524-21-84-C5	03080242	21,0 0.827	84,0 3.307	89,0 3.504	125,0 4.921	50,0 1.969	SPGX0602	SCGX060204
SD524-22-88-C5	03080243	22,0 0.866	88,0 3.465	93,0 3.661	129,0 5.079	50,0 1.969	SPGX0703	SCGX060204
SD524-22.23-89-C5	03080409	22,23 0.875	89,0 3.504	94,0 3.701	130,0 5.118	50,0 1.969	SPGX0703	SCGX060204
SD524-23-92-C5	03080244	23,0 0.906	92,0 3.622	97,0 3.819	134,0 5.276	50,0 1.969	SPGX0703	SCGX070308
SD524-24-96-C5	03080245	24,0 0.945	96,0 3.780	101,0 3.976	139,0 5.472	50,0 1.969	SPGX0703	SCGX070308
SD524-25-100-C5	03080246	25,0 0.984	100,0 3.937	105,0 4.134	144,0 5.669	50,0 1.969	SPGX0703	SCGX070308
SD524-25.4-102-C5	03080410	25,4 1.000	102,0 4.016	107,0 4.213	146,0 5.748	50,0 1.969	SPGX0703	SCGX070308
SD524-26-104-C5	03080247	26,0 1.024	104,0 4.094	109,0 4.291	148,0 5.827	50,0 1.969	SPGX0903	SCGX070308
SD524-27-108-C5	03080248	27,0 1.063	108,0 4.252	113,0 4.449	152,0 5.984	50,0 1.969	SPGX0903	SCGX070308
SD524-28-112-C5	03080249	28,0 1.102	112,0 4.409	117,0 4.606	157,0 6.181	50,0 1.969	SPGX0903	SCGX070308
SD524-28.59-115-C5	03080411	28,59 1.126	115,0 4.528	120,0 4.724	160,0 6.299	50,0 1.969	SPGX0903	SCGX070308
SD524-29-116-C5	03080250	29,0 1.142	116,0 4.567	121,0 4.764	161,0 6.339	50,0 1.969	SPGX0903	SCGX09T308
SD524-30-120-C5	03080251	30,0 1.181	120,0 4.724	125,0 4.921	165,0 6.496	50,0 1.969	SPGX0903	SCGX09T308
SD524-31-124-C5	03080252	31,0 1.220	124,0 4.882	129,0 5.079	169,0 6.654	50,0 1.969	SPGX0903	SCGX09T308
SD524-31.75-127-C5	03080412	31,75 1.250	127,0 5.000	132,0 5.197	173,0 6.811	50,0 1.969	SPGX11T3	SCGX09T308

Introduzione

Foratura

Alesatura

Barenatura

Allegato

Codice di ordinazione	Codice prodotto	DC	LU	LUX	LFS	DF	Inserto	
		mm Inch	mm Inch	mm Inch	mm Inch	mm Inch	Inserto centrale	Inserto periferico
SD524-32-128-C5	03080253	32,0 1.260	128,0 5.039	133,0 5.236	174,0 6.850	50,0 1.969	SPGX11T3	SCGX09T308
SD524-33-132-C5	03080254	33,0 1.299	132,0 5.197	137,0 5.394	178,0 7.008	50,0 1.969	SPGX11T3	SCGX09T308
SD524-34-136-C5	03080255	34,0 1.339	136,0 5.354	141,0 5.551	182,0 7.165	50,0 1.969	SPGX11T3	SCGX09T308
SD524-35-140-C5	03080256	35,0 1.378	140,0 5.512	145,0 5.709	186,0 7.323	50,0 1.969	SPGX11T3	SCGX11T308
SD524-36-144-C5	03080257	36,0 1.417	144,0 5.669	149,0 5.866	190,0 7.480	50,0 1.969	SPGX11T3	SCGX11T308
SD524-37-148-C5	03080258	37,0 1.457	148,0 5.827	153,0 6.024	194,0 7.638	50,0 1.969	SPGX11T3	SCGX11T308
SD524-38-152-C5	03080259	38,0 1.496	152,0 5.984	157,0 6.181	198,0 7.795	50,0 1.969	SPGX12T3	SCGX11T308
SD524-39-156-C5	03080260	39,0 1.535	156,0 6.142	161,0 6.339	202,0 7.953	50,0 1.969	SPGX12T3	SCGX11T308
SD524-40-160-C5	03080261	40,0 1.575	160,0 6.299	165,0 6.496	206,0 8.110	50,0 1.969	SPGX12T3	SCGX11T308

Parti di ricambio, comprese nella fornitura

Per punta diametro (mm)	Vite di bloccaggio inserto		Chiave per vite inserto
			
	Inserto centrale	Inserto periferico	
15,00-17,45	C02245-T07P	C02245-T07P	T07P-2
17,46-19,49	C02205-T07P	C02245-T07P	T07P-2
19,50-21,24	C02205-T07P	C02205-T07P	T07P-2
21,25-22,49	C02506-T08P	C02506-T08P	T08P-2
22,50-25,49	C02507-T08P	C03007-T08P	T08P-2
25,50-28,49	C03007-T09P	C03007-T09P	T09P-2
28,50-31,49	C03007-T09P	C03009-T09P	T09P-2
31,50-40,49	C03508-T15P	C03508-T15P	T15P-2D
40,50-43,24	C03508-T15P	C05012-T15P	T15P-2D
43,25-59,00	C04011-T15P	C05012-T15P	T15P-2D

Accessori

Per punta diametro (mm)	Chiave dinamometrica*	Bit sostituibile	Valore di coppia
			
15,00-17,45	T00-07P09	T00-07P	0,9 Nm
17,46-19,49	T00-07P09	T00-07P	0,9 Nm
19,50-21,24	T00-07P09	T00-07P	0,9 Nm
21,25-22,49	T00-08P12	T00-08P	1,2 Nm
22,50-25,49	T00-08P12	T00-08P	1,2 Nm
25,50-28,49	T00-09P20	T00-09P	2,0 Nm
28,50-31,49	T00-09P20	T00-09P	2,0 Nm
31,50-40,49	T00-15P30	T00-15P	3,0 Nm
40,50-43,24	T00-15P30	T00-15P	3,0 Nm
43,25-59,00	T00-15P30	T00-15P	3,0 Nm

*Lama inclusa.

SD524

Profondità di foratura ~ 4 x D – Misure metriche/Pollici

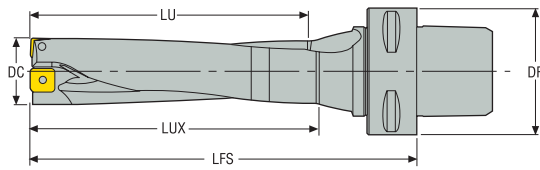

- Codolo C6 Seco-Capto™
- Adduzione refrigerante interna
- Per le informazioni sugli inserti, vedere pagina(e) 297-303
- Per i parametri di taglio raccomandati, vedere pagina(e) 308, 309
- Per i diametri intermedi, utilizzare MyDesign.

Codice di ordinazione	Codice prodotto	DC	LU	LUX	LFS	DF	Inserto	
		mm <i>Inch</i>	mm <i>Inch</i>	mm <i>Inch</i>	mm <i>Inch</i>	mm <i>Inch</i>	Inserto centrale	Inserto periferico
SD524-17-68-C6	03080262	17,0 <i>0.669</i>	68,0 <i>2.677</i>	73,0 <i>2.874</i>	108,0 <i>4.252</i>	63,0 <i>2.480</i>	SPGX0502	SCGX050204
SD524-17.5-70-C6	03080263	17,5 <i>0.689</i>	70,0 <i>2.756</i>	75,0 <i>2.953</i>	111,0 <i>4.370</i>	63,0 <i>2.480</i>	SPGX0602	SCGX050204
SD524-18-72-C6	03080265	18,0 <i>0.709</i>	72,0 <i>2.835</i>	77,0 <i>3.031</i>	113,0 <i>4.449</i>	63,0 <i>2.480</i>	SPGX0602	SCGX050204
SD524-18.5-74-C6	03080266	18,5 <i>0.728</i>	74,0 <i>2.913</i>	79,0 <i>3.110</i>	115,0 <i>4.528</i>	63,0 <i>2.480</i>	SPGX0602	SCGX050204
SD524-19-76-C6	03080267	19,0 <i>0.748</i>	76,0 <i>2.992</i>	81,0 <i>3.189</i>	117,0 <i>4.606</i>	63,0 <i>2.480</i>	SPGX0602	SCGX050204
SD524-20-80-C6	03080268	20,0 <i>0.787</i>	80,0 <i>3.150</i>	85,0 <i>3.346</i>	123,0 <i>4.843</i>	63,0 <i>2.480</i>	SPGX0602	SCGX060204
SD524-20.62-83-C6	03080417	20,62 <i>0.812</i>	83,0 <i>3.268</i>	88,0 <i>3.465</i>	126,0 <i>4.961</i>	63,0 <i>2.480</i>	SPGX0602	SCGX060204
SD524-21-84-C6	03080269	21,0 <i>0.827</i>	84,0 <i>3.307</i>	89,0 <i>3.504</i>	127,0 <i>5.000</i>	63,0 <i>2.480</i>	SPGX0602	SCGX060204
SD524-22-88-C6	03080270	22,0 <i>0.866</i>	88,0 <i>3.465</i>	93,0 <i>3.661</i>	131,0 <i>5.157</i>	63,0 <i>2.480</i>	SPGX0703	SCGX060204
SD524-22.23-89-C6	03080418	22,23 <i>0.875</i>	89,0 <i>3.504</i>	94,0 <i>3.701</i>	132,0 <i>5.197</i>	63,0 <i>2.480</i>	SPGX0703	SCGX060204
SD524-23-92-C6	03080271	23,0 <i>0.906</i>	92,0 <i>3.622</i>	97,0 <i>3.819</i>	136,0 <i>5.354</i>	63,0 <i>2.480</i>	SPGX0703	SCGX070308
SD524-24-96-C6	03080272	24,0 <i>0.945</i>	96,0 <i>3.780</i>	101,0 <i>3.976</i>	141,0 <i>5.551</i>	63,0 <i>2.480</i>	SPGX0703	SCGX070308
SD524-25-100-C6	03080392	25,0 <i>0.984</i>	100,0 <i>3.937</i>	105,0 <i>4.134</i>	146,0 <i>5.748</i>	63,0 <i>2.480</i>	SPGX0703	SCGX070308
SD524-25.4-102-C6	03080419	25,4 <i>1.000</i>	102,0 <i>4.016</i>	107,0 <i>4.213</i>	148,0 <i>5.827</i>	63,0 <i>2.480</i>	SPGX0703	SCGX070308
SD524-26-104-C6	03080393	26,0 <i>1.024</i>	104,0 <i>4.094</i>	109,0 <i>4.291</i>	150,0 <i>5.906</i>	63,0 <i>2.480</i>	SPGX0903	SCGX070308
SD524-27-108-C6	03080394	27,0 <i>1.063</i>	108,0 <i>4.252</i>	113,0 <i>4.449</i>	154,0 <i>6.063</i>	63,0 <i>2.480</i>	SPGX0903	SCGX070308
SD524-28-112-C6	03080395	28,0 <i>1.102</i>	112,0 <i>4.409</i>	117,0 <i>4.606</i>	159,0 <i>6.260</i>	63,0 <i>2.480</i>	SPGX0903	SCGX070308
SD524-28.59-115-C6	03080420	28,59 <i>1.126</i>	115,0 <i>4.528</i>	120,0 <i>4.724</i>	162,0 <i>6.378</i>	63,0 <i>2.480</i>	SPGX0903	SCGX070308
SD524-29-116-C6	03080396	29,0 <i>1.142</i>	116,0 <i>4.567</i>	121,0 <i>4.764</i>	163,0 <i>6.417</i>	63,0 <i>2.480</i>	SPGX0903	SCGX09T308
SD524-30-120-C6	03080397	30,0 <i>1.181</i>	120,0 <i>4.724</i>	125,0 <i>4.921</i>	167,0 <i>6.575</i>	63,0 <i>2.480</i>	SPGX0903	SCGX09T308
SD524-31-124-C6	03080398	31,0 <i>1.220</i>	124,0 <i>4.882</i>	129,0 <i>5.079</i>	171,0 <i>6.732</i>	63,0 <i>2.480</i>	SPGX0903	SCGX09T308
SD524-31.75-127-C6	03080421	31,75 <i>1.250</i>	127,0 <i>5.000</i>	132,0 <i>5.197</i>	175,0 <i>6.890</i>	63,0 <i>2.480</i>	SPGX0903	SCGX09T308

Introduzione

Foratura



Alesatura

Barenatura



Allegato

Codice di ordinazione	Codice prodotto	DC	LU	LUX	LFS	DF	Inserto	
		mm Inch	mm Inch	mm Inch	mm Inch	mm Inch	Inserto centrale	Inserto periferico
SD524-32-128-C6	03080399	32,0 1.260	128,0 5.039	133,0 5.236	176,0 6.929	63,0 2.480	SPGX11T3	SCGX09T308
SD524-33-132-C6	03080400	33,0 1.299	132,0 5.197	137,0 5.394	180,0 7.087	63,0 2.480	SPGX11T3	SCGX09T308
SD524-34-136-C6	03080401	34,0 1.339	136,0 5.354	141,0 5.551	184,0 7.244	63,0 2.480	SPGX11T3	SCGX09T308
SD524-35-140-C6	03080402	35,0 1.378	140,0 5.512	145,0 5.709	188,0 7.402	63,0 2.480	SPGX11T3	SCGX11T308
SD524-36-144-C6	03080403	36,0 1.417	144,0 5.669	149,0 5.866	192,0 7.559	63,0 2.480	SPGX11T3	SCGX11T308
SD524-37-148-C6	03080404	37,0 1.457	148,0 5.827	153,0 6.024	196,0 7.717	63,0 2.480	SPGX11T3	SCGX11T308
SD524-38-152-C6	03080405	38,0 1.496	152,0 5.984	157,0 6.181	200,0 7.874	63,0 2.480	SPGX12T3	SCGX11T308
SD524-39-156-C6	03080406	39,0 1.535	156,0 6.142	161,0 6.339	204,0 8.031	63,0 2.480	SPGX12T3	SCGX11T308
SD524-40-160-C6	03080407	40,0 1.575	160,0 6.299	165,0 6.496	208,0 8.189	63,0 2.480	SPGX12T3	SCGX11T308

Parti di ricambio, comprese nella fornitura

Per punta diametro (mm)	Vite di bloccaggio inserto		Chiave per vite inserto
			
	Inserto centrale	Inserto periferico	
15,00-17,45	C02245-T07P	C02245-T07P	T07P-2
17,46-19,49	C02205-T07P	C02245-T07P	T07P-2
19,50-21,24	C02205-T07P	C02205-T07P	T07P-2
21,25-22,49	C02506-T08P	C02506-T08P	T08P-2
22,50-25,49	C02507-T08P	C03007-T08P	T08P-2
25,50-28,49	C03007-T09P	C03007-T09P	T09P-2
28,50-31,49	C03007-T09P	C03009-T09P	T09P-2
31,50-40,49	C03508-T15P	C03508-T15P	T15P-2D
40,50-43,24	C03508-T15P	C05012-T15P	T15P-2D
43,25-59,00	C04011-T15P	C05012-T15P	T15P-2D

Accessori

Per punta diametro (mm)	Chiave dinamometrica*	Bit sostituibile	Valore di coppia
			
15,00-17,45	T00-07P09	T00-07P	0,9 Nm
17,46-19,49	T00-07P09	T00-07P	0,9 Nm
19,50-21,24	T00-07P09	T00-07P	0,9 Nm
21,25-22,49	T00-08P12	T00-08P	1,2 Nm
22,50-25,49	T00-08P12	T00-08P	1,2 Nm
25,50-28,49	T00-09P20	T00-09P	2,0 Nm
28,50-31,49	T00-09P20	T00-09P	2,0 Nm
31,50-40,49	T00-15P30	T00-15P	3,0 Nm
40,50-43,24	T00-15P30	T00-15P	3,0 Nm
43,25-59,00	T00-15P30	T00-15P	3,0 Nm

*Lama inclusa.

SD525

Profondità di foratura ~ 5 x D – Misure metriche/Pollici

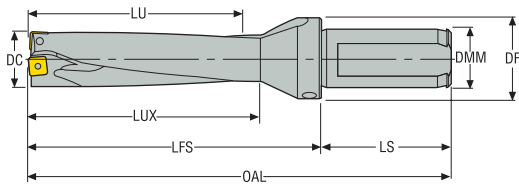

- Codolo ISO 9766, -7
- Adduzione refrigerante interna
- Per le informazioni sugli inserti, vedere pagina(e) 297-303
- Per i parametri di taglio raccomandati, vedere pagina(e) 310, 311
- Per i diametri intermedi, utilizzare MyDesign.

Codice di ordinazione	Codice prodotto	DC	LU	OAL	LUX	LFS	LS	DMM	DF	Inserto	
										mm Inch	mm Inch
SD525-19-95-25R7	03079580	19,0 0.748	95,0 3.740	181,0 7.126	100,0 3.937	125,0 4.921	56,0 2.205	25,0 0.984	35,0 1.378	SPGX0602	SCGX050204
SD525-20-100-25R7	03079582	20,0 0.787	100,0 3.937	186,0 7.323	105,0 4.134	130,0 5.118	56,0 2.205	25,0 0.984	35,0 1.378	SPGX0602	SCGX060204
SD525-21-105-25R7	03079583	21,0 0.827	105,0 4.134	191,0 7.520	110,0 4.331	135,0 5.315	56,0 2.205	25,0 0.984	35,0 1.378	SPGX0602	SCGX060204
SD525-22-110-25R7	03079584	22,0 0.866	110,0 4.331	196,0 7.717	115,0 4.528	140,0 5.512	56,0 2.205	25,0 0.984	35,0 1.378	SPGX0703	SCGX060204
SD525-23-115-25R7	03079585	23,0 0.906	115,0 4.528	201,0 7.913	120,0 4.724	145,0 5.709	56,0 2.205	25,0 0.984	35,0 1.378	SPGX0703	SCGX070308
SD525-24-120-25R7	03079586	24,0 0.945	120,0 4.724	206,0 8.110	125,0 4.921	150,0 5.906	56,0 2.205	25,0 0.984	35,0 1.378	SPGX0703	SCGX070308
SD525-25-125-32R7	03079587	25,0 0.984	125,0 4.921	215,0 8.465	130,0 5.118	155,0 6.102	60,0 2.362	32,0 1.260	42,0 1.654	SPGX0703	SCGX070308
SD525-26-130-32R7	03079588	26,0 1.024	130,0 5.118	220,0 8.661	135,0 5.315	160,0 6.299	60,0 2.362	32,0 1.260	42,0 1.654	SPGX0903	SCGX070308
SD525-27-135-32R7	03079589	27,0 1.063	135,0 5.315	225,0 8.858	140,0 5.512	165,0 6.496	60,0 2.362	32,0 1.260	42,0 1.654	SPGX0903	SCGX070308
SD525-28-140-32R7	03079590	28,0 1.102	140,0 5.512	230,0 9.055	145,0 5.709	170,0 6.693	60,0 2.362	32,0 1.260	42,0 1.654	SPGX0903	SCGX070308
SD525-29-145-32R7	03079591	29,0 1.142	145,0 5.709	235,0 9.252	150,0 5.906	175,0 6.890	60,0 2.362	32,0 1.260	42,0 1.654	SPGX0903	SCGX09T308
SD525-30-150-32R7	03079592	30,0 1.181	150,0 5.906	240,0 9.449	155,0 6.102	180,0 7.087	60,0 2.362	32,0 1.260	42,0 1.654	SPGX0903	SCGX09T308
SD525-31-155-32R7	03079593	31,0 1.220	155,0 6.102	245,0 9.646	160,0 6.299	185,0 7.283	60,0 2.362	32,0 1.260	42,0 1.654	SPGX0903	SCGX09T308
SD525-32-160-40R7	03079595	32,0 1.260	160,0 6.299	258,0 10.157	165,0 6.496	190,0 7.480	68,0 2.677	40,0 1.575	50,0 1.969	SPGX11T3	SCGX09T308
SD525-33-165-40R7	03079596	33,0 1.299	165,0 6.496	263,0 10.354	170,0 6.693	195,0 7.677	68,0 2.677	40,0 1.575	50,0 1.969	SPGX11T3	SCGX09T308
SD525-34-170-40R7	03079597	34,0 1.339	170,0 6.693	268,0 10.551	175,0 6.890	200,0 7.874	68,0 2.677	40,0 1.575	50,0 1.969	SPGX11T3	SCGX09T308
SD525-35-175-40R7	03079598	35,0 1.378	175,0 6.890	273,0 10.748	180,0 7.087	205,0 8.071	68,0 2.677	40,0 1.575	50,0 1.969	SPGX11T3	SCGX11T308
SD525-36-180-40R7	03079599	36,0 1.417	180,0 7.087	278,0 10.945	185,0 7.283	210,0 8.268	68,0 2.677	40,0 1.575	50,0 1.969	SPGX11T3	SCGX11T308
SD525-37-185-40R7	03079600	37,0 1.457	185,0 7.283	283,0 11.142	190,0 7.480	215,0 8.465	68,0 2.677	40,0 1.575	50,0 1.969	SPGX11T3	SCGX11T308
SD525-38-190-40R7	03079601	38,0 1.496	190,0 7.480	288,0 11.339	195,0 7.677	220,0 8.661	68,0 2.677	40,0 1.575	50,0 1.969	SPGX12T3	SCGX11T308
SD525-39-195-40R7	03079602	39,0 1.535	195,0 7.677	293,0 11.535	200,0 7.874	225,0 8.858	68,0 2.677	40,0 1.575	50,0 1.969	SPGX12T3	SCGX11T308
SD525-40-200-40R7	03079603	40,0 1.575	200,0 7.874	298,0 11.732	205,0 8.071	230,0 9.055	68,0 2.677	40,0 1.575	50,0 1.969	SPGX12T3	SCGX11T308

Introduzione

Foratura

Alesatura

Barenatura

Allegato

Introduzione

Codice di ordinazione	Codice prodotto	DC	LU	OAL	LUX	LFS	LS	DMM	DF	Inserto	
		mm Inch	mm Inch	mm Inch	mm Inch	mm Inch	mm Inch	mm Inch	mm Inch	mm Inch	Inserto centrale
SD525-41-205-40R7	03079604	41,0 1.614	205,0 8.071	303,0 11.929	210,0 8.268	235,0 9.252	68,0 2.677	40,0 1.575	50,0 1.969	SPGX12T3	SCGX120408
SD525-42-210-40R7	03079605	42,0 1.654	210,0 8.268	308,0 12.126	215,0 8.465	240,0 9.449	68,0 2.677	40,0 1.575	50,0 1.969	SPGX12T3	SCGX120408
SD525-43-215-40R7	03079606	43,0 1.693	215,0 8.465	313,0 12.323	220,0 8.661	245,0 9.646	68,0 2.677	40,0 1.575	50,0 1.969	SPGX12T3	SCGX120408
SD525-44-220-40R7	03079607	44,0 1.732	220,0 8.661	318,0 12.520	225,0 8.858	250,0 9.843	68,0 2.677	40,0 1.575	50,0 1.969	SPGX1504	SCGX120408
SD525-45-225-40R7	03079608	45,0 1.772	225,0 8.858	323,0 12.717	230,0 9.055	255,0 10.039	68,0 2.677	40,0 1.575	50,0 1.969	SPGX1504	SCGX150512

Foratura

Parti di ricambio, comprese nella fornitura

Per punta diametro (mm)	Vite di bloccaggio inserto		Chiave per vite inserto
	Inserto centrale	Inserto periferico	
15,00-17,45	C02245-T07P	C02245-T07P	T07P-2
17,46-19,49	C02205-T07P	C02245-T07P	T07P-2
19,50-21,24	C02205-T07P	C02205-T07P	T07P-2
21,25-22,49	C02506-T08P	C02506-T08P	T08P-2
22,50-25,49	C02507-T08P	C03007-T08P	T08P-2
25,50-28,49	C03007-T09P	C03007-T09P	T09P-2
28,50-31,49	C03007-T09P	C03009-T09P	T09P-2
31,50-40,49	C03508-T15P	C03508-T15P	T15P-2D
40,50-43,24	C03508-T15P	C05012-T15P	T15P-2D
43,25-59,00	C04011-T15P	C05012-T15P	T15P-2D

Alesatura

Accessori

Per punta diametro (mm)	Chiave dinamometrica*	Bit sostituibile	Valore di coppia
15,00-17,45	T00-07P09	T00-07P	0,9 Nm
17,46-19,49	T00-07P09	T00-07P	0,9 Nm
19,50-21,24	T00-07P09	T00-07P	0,9 Nm
21,25-22,49	T00-08P12	T00-08P	1,2 Nm
22,50-25,49	T00-08P12	T00-08P	1,2 Nm
25,50-28,49	T00-09P20	T00-09P	2,0 Nm
28,50-31,49	T00-09P20	T00-09P	2,0 Nm
31,50-40,49	T00-15P30	T00-15P	3,0 Nm
40,50-43,24	T00-15P30	T00-15P	3,0 Nm
43,25-59,00	T00-15P30	T00-15P	3,0 Nm

Barenatura

*Lama inclusa.

Allegato

SD525

Profondità di foratura ~ 5 x D – Pollici

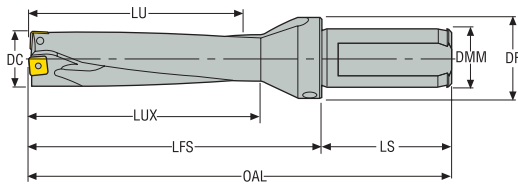

- Codolo ISO 9766, -7
- Adduzione refrigerante interna
- Per le informazioni sugli inserti, vedere pagina(e) 297-303
- Per i parametri di taglio raccomandati, vedere pagina(e) 310, 311
- Per i diametri intermedi, utilizzare MyDesign.

Codice di ordinazione	Codice prodotto	DC	LU	OAL	LUX	LFS	LS	DMM	DF	Inserto	
		Inch	Inch	Inch	Inch	Inch	Inch	Inch	Inch	Inch	Inserto centrale
SD525-0750-375-1000R7	03079565	0.750	3.750	7.181	3.947	4.931	2.250	1.000	1.378	SPGX0602	SCGX050204
SD525-0812-406-1000R7	03079566	0.812	4.060	7.491	4.257	5.241	2.250	1.000	1.378	SPGX0602	SCGX060204
SD525-0875-438-1000R7	03079567	0.875	4.380	7.811	4.577	5.561	2.250	1.000	1.378	SPGX0703	SCGX060204
SD525-0937-469-1000R7	03079568	0.937	4.690	8.121	4.887	5.871	2.250	1.000	1.378	SPGX0703	SCGX070308
SD525-1000-500-1250R7	03079569	1.000	5.000	8.556	5.197	6.181	2.375	1.250	1.654	SPGX0703	SCGX070308
SD525-1062-531-1250R7	03079570	1.062	5.310	8.866	5.507	6.491	2.375	1.250	1.654	SPGX0903	SCGX070308
SD525-1125-563-1250R7	03079571	1.125	5.630	9.186	5.827	6.811	2.375	1.250	1.654	SPGX0903	SCGX09T308
SD525-1187-594-1250R7	03079572	1.187	5.940	9.496	6.137	7.121	2.375	1.250	1.654	SPGX0903	SCGX09T308
SD525-1250-625-1500R7	03079573	1.250	6.250	10.056	6.447	7.431	2.625	1.500	1.969	SPGX11T3	SCGX09T308
SD525-1375-687-1500R7	03079574	1.375	6.870	10.676	7.067	8.051	2.625	1.500	1.969	SPGX11T3	SCGX11T308
SD525-1500-750-1500R7	03079575	1.500	7.500	11.306	7.697	8.681	2.625	1.500	1.969	SPGX12T3	SCGX11T308
SD525-1625-812-1500R7	03079576	1.625	8.120	11.926	8.317	9.301	2.625	1.500	1.969	SPGX12T3	SCGX120408
SD525-1750-875-1500R7	03079577	1.750	8.750	12.556	8.947	9.931	2.625	1.500	1.969	SPGX1504	SCGX120408
SD525-1875-937-1500R7	03079578	1.875	9.370	13.176	9.567	10.551	2.625	1.500	1.969	SPGX1504	SCGX150512
SD525-1937-968-1500R7	03079579	1.937	9.680	13.486	9.877	10.861	2.625	1.500	2.337	SPGX1504	SCGX150512
SD525-2000-1000-1500R7	03079581	2.000	10.000	13.806	10.197	11.181	2.625	1.500	2.337	SPGX1504	SCGX150512

Parti di ricambio, comprese nella fornitura
Accessori

Per punta diametro (pollici)	Vite di bloccaggio inserto centrale	Vite di bloccaggio inserto periferico	Chiave	Chiave dinamometrica
0.750	 C02205-T07P	 C02245-T07P	 T07P-2	 T00-07P09
0.812	C02205-T07P	C02205-T07P	T07P-2	T00-07P09
0.875	C02506-T08P	C02506-T08P	T08P-2	T00-08P12
0.937-1.000	C02507-T08P	C03007-T08P	T08P-2	T00-08P12
1.062	C03007-T09P	C03007-T09P	T09P-2	T00-09P20
1.125-1.187	C03007-T09P	C03009-T09P	T09P-2	T00-09P20
1.250-1.500	C03508-T15P	C03508-T15P	T15P-2D	T00-15P30
1.625	C03508-T15P	C05012-T15P	T15P-2D	T00-15P30
1.750-2.000	C04011-T15P	C05012-T15P	T15P-2D	T00-15P35

SD542

Profondità di foratura ~ 2,5 x D – Misure metriche

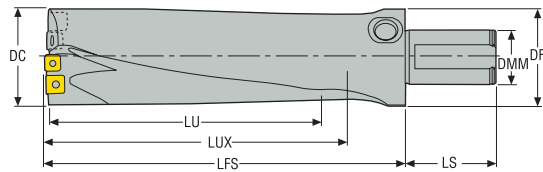

- Codolo ISO 9766, -7
- Adduzione refrigerante interna
- Per le informazioni sugli inserti, vedere pagina(e) 297-303
- Per i parametri di taglio raccomandati, vedere pagina(e) 312, 313
- Per i diametri intermedi, utilizzare MyDesign.

Codice di ordinazione	Codice prodotto	DC	LU	LUX	LFS	LS	DMM	DF	Inserto	
		mm	mm	mm	mm	mm	mm	mm	Inserto centrale	Inserto periferico
SD542-60-150-40R7	02590456	60,0	150,0	156,0	201,5	68,0	40,0	79,0	SPGX0903-C1	SCGX09T308..
SD542-65-162.5-40R7	02590457	65,0	162,5	169,5	214,0	68,0	40,0	79,0	SPGX11T3-C1	SCGX09T308..
SD542-70-175-40R7	02590458	70,0	175,0	182,5	226,5	68,0	40,0	79,0	SPGX11T3-C1	SCGX120408..
SD542-75-187.5-50R7	02590459	75,0	187,5	196,0	239,0	78,0	50,0	79,0	SPGX11T3-C1	SCGX120408..
SD542-80-200-50R7	02590460	80,0	200,0	210,0	251,5	78,0	50,0	79,0	SPGX12T3-C1	SCGX120408..
SD542-85-212.5-50R7	02590461	85,0	212,5	221,0	264,0	78,0	50,0	89,0	SPGX12T3-C1	SCGX120408..

Parti di ricambio, comprese nella fornitura

Per punta diametro (mm)	Vite di bloccaggio inserto	Chiave per vite inserto	Grano	Adattatore
	Inserto centrale	Inserto periferico		
60,00-64,99	C03007-T09P	C03009-T09P	T09P-2	R3/8
65,00-68,99	C03508-T15P	C03508-T15P	T15P-2D	R3/8
69,00-86,99	C03508-T15P	C05012-T15P	T15P-2D	R3/8

Accessori

Per punta diametro (mm)	Chiave dinamometrica*	Bit sostituibile	Valore di coppia
15,00-17,45	T00-09P20	T00-09P	3,0 Nm
17,46-19,49	T00-15P30	T00-15P	3,0 Nm
19,50-21,24	T00-15P30	T00-15P	3,0 Nm

*Lama inclusa.

SD542

Profondità di foratura ~ 2.5 X D – Pollici

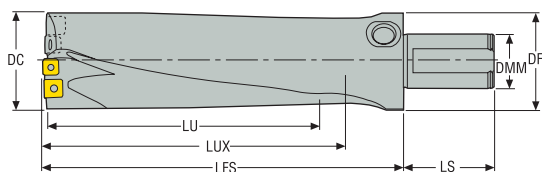

- Codolo ISO 9766, -7
- Adduzione refrigerante interna
- Per le informazioni sugli inserti, vedere pagina(e) 297-303
- Per i parametri di taglio raccomandati, vedere pagina(e) 312, 313
- Per i diametri intermedi, utilizzare MyDesign.

Codice di ordinazione	Codice prodotto	DC	LU	LUX	LFS	LS	DMM	DF	Inserto	
									Inserto centrale	Inserto periferico
		Inch	Inch	Inch	Inch	Inch	Inch	Inch		
SD542-2250-563-1500R7	02602085	2.250	5.630	5.800	7.000	4.500	1.500	3.110	SPGX 0903-C1	SCGX 09T308..
SD542-2500-625-1500R7	02602087	2.500	6.250	6.520	8.280	4.500	1.500	3.110	SPGX 0903-C1	SCGX 09T308..
SD542-2750-688-1500R7	02602088	2.750	6.880	7.190	8.900	4.500	1.500	3.110	SPGX 11T3-C1	SCGX 120408..
SD542-3000-750-2000R7	02602089	3.000	7.500	7.860	9.530	4.500	2.000	3.110	SPGX 11T3-C1	SCGX 120408..
SD542-3250-813-2500R7	02602090	3.250	8.130	8.460	10.150	4.500	2.500	3.500	SPGX 12T3-C1	SCGX 120408..
SD542-3500-875-2500R7	02602091	3.500	8.750	9.140	10.780	4.500	2.500	3.500	SPGX 1504-C1	SCGX 120408..

Parti di ricambio, comprese nella fornitura

Per punta diametro (mm)	Vite di bloccaggio inserto		Chiave per vite inserto	Grano	Adattatore
	Inserto centrale	Inserto periferico			
60,00-64,99	C03007-T09P	C03009-T09P	T09P-2	R3/8	R3/8-HA
65,00-68,99	C03508-T15P	C03508-T15P	T15P-2D	R3/8	R3/8-HA
69,00-86,99	C03508-T15P	C05012-T15P	T15P-2D	R3/8	R3/8-HA

Accessori

Per punta diametro (mm)	Chiave dinamometrica*	Bit sostituibile	Valore di coppia
15,00-17,45	T00-09P20	T00-09P	3,0 Nm
17,46-19,49	T00-15P30	T00-15P	3,0 Nm
19,50-21,24	T00-15P30	T00-15P	3,0 Nm

*Lama inclusa.

SD572

Profondità di foratura ~ 2 x D – Misure metriche

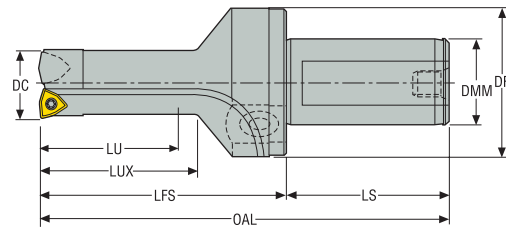



- Codolo ISO 9766, -7
- Adduzione refrigerante interna
- Per le informazioni sugli inserti, vedere pagina(e) 297-303
- Per i parametri di taglio raccomandati, vedere pagina(e) 314-315
- Per i diametri intermedi, utilizzare MyDesign.

Codice di ordinazione	Codice prodotto	Diam. foro min-max	DC	LU	LUX	LFS	LS	DMM	DF	Inserto	
										mm	mm
SD572-15-30-25R7	02595777	14,8 -18	15,0	30,0	35,0	65,0	56,0	25,0	42,0	WCMX030208-86	WCMX030208..
SD572-16-32-25R7	02595778	15,8 -18	16,0	32,0	37,0	67,0	56,0	25,0	42,0	WCMX030208-86	WCMX030208..
SD572-17-34-25R7	02595779	16,8 -19	17,0	34,0	39,0	69,0	56,0	25,0	42,0	WCMX030208-86	WCMX030208..
SD572-19-38-25R7	02595780	18,8 -22	19,0	38,0	43,0	73,0	56,0	25,0	42,0	WCMX040208-86	WCMX030208..
SD572-22-44-25R7	02595781	21,8 -27	22,0	44,0	49,0	79,0	56,0	25,0	42,0	WCMX050308-86	WCMX040208..
SD572-27-54-32R7	02595783	26,8 -33	27,0	54,0	59,0	89,0	60,0	32,0	50,0	WCMX06T308-86	WCMX050308..
SD572-33-66-40R7	02595784	32,8 -41	33,0	66,0	71,0	101,0	68,0	40,0	59,0	WCMX080412-86	WCMX06T308..
SD572-41-82-40R7	02595785	40,8 -47	41,0	82,0	87,0	117,0	68,0	40,0	59,0	WCMX080412-86	WCMX080412..
SD572-47-94-40R7	02595786	46,8 -52	47,0	94,0	99,0	129,0	68,0	40,0	59,0	WCMX080412-86	WCMX080412..

Parti di ricambio, comprese nella fornitura

Per punta diametro (mm)	Vite di bloccaggio inserto		Chiave per vite inserto	Grano	Adattatore
	Inserto centrale	Inserto periferico			
15,00-20,50	C02205-T07P	C02205-T07P	T07P-2	R1/4	1310
20,51-24,50	C03007-T08P	C02506-T08P	T08P-2	R1/4	1310
24,51-32,50	C03508-T15P	C03007-T08P	T08P-2, T15P-2D	R1/4	1310
32,51-36,50	C03508-T15P	C03508-T15P	T15P-2D	R1/4	1310
36,51-59,00	C04011-T15P	C04011-T15P	T15P-2D	R1/4	1310

Accessori

Per punta diametro (mm)	Chiave dinamometrica*	Bit sostituibile	Valore di coppia
			
15,00-20,50	T00-07P09	T00-07P	0,9 Nm
20,51-24,50	T00-08P12	T00-08P	1,2 Nm
24,51-32,50	T00-08P12	T00-08P	1,2 Nm
32,51-36,50	T00-15P30	T00-15P	3,0 Nm
36,51-59,00	T00-15P30	T00-15P	3,0 Nm

*Lama inclusa.

Introduzione

Foratura

Alesatura

Barenatura

Allegato

SD572

Profondità di foratura ~ 2 x D – Pollici

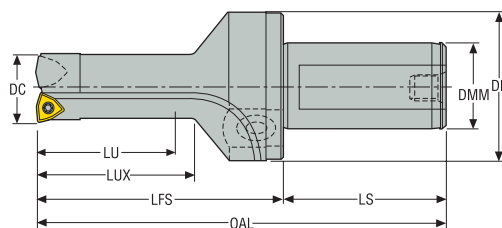

- Codolo ISO 9766, -7
- Adduzione refrigerante interna
- Per le informazioni sugli inserti, vedere pagina(e) 297-303
- Per i parametri di taglio raccomandati, vedere pagina(e) 314-315
- Per i diametri intermedi, utilizzare MyDesign.

Codice di ordinazione	Codice prodotto	Diam. foro min-max (pollici)	DC	LU	LUX	LFS	DF	Inserto	
		Inch	Inch	Inch	Inch	Inch	Inch	Inserto centrale	Inserto periferico
SD572-0591-118-1000R7	02602128	0.591--	0.591	1.182	1.379	2,56	1,775	WCMX030208-86	WCMX 030208..
SD572-0669-134-1000R7	02602129	0.669--	0.669	1.338	1.535	2,716	1,775	WCMX030208-86	WCMX 030208..
SD572-0748-150-1000R7	02602131	0.748--	0.748	1.496	1.69	2,874	1,775	WCMX040208-86	WCMX 030208..
SD572-0866-173-1000R7	02602132	0.866--	0.866	1.732	1.929	3,11	1,775	WCMX050308-86	WCMX 040208..
SD572-1062-212-1250R7	02602133	1.062--	1.062	2.124	2.321	3,502	2,165	WCMX06T308-86	WCMX 050308..
SD572-1299-260-1500R7	02602134	1.299--	1.299	2.598	2.795	3,976	2,303	WCMX080412-86	WCMX 06T308..
SD572-1614-322-1500R7	02602135	1.614--	1.614	3.228	3.425	4,606	2,303	WCMX080412-86	WCMX 080412..
SD572-1850-370-1500R7	02602136	1.850--	1.85	3.7	3.7	5,078	2,303	WCMX080412-86	WCMX 080412..

Parti di ricambio, comprese nella fornitura

Per punta diametro (pollici)	Connettore refrigerante	Chiave per vite inserto	Vite di bloccaggio inserto centrale	Vite di bloccaggio inserto periferico	Chiave (a bandiera)	Vite
0.591-0.748	1310	T07P-2	C02205-T07P	C02245-T07P	C02245-T07P	R1/4
0.866	1310	T08P-2	C02506-T08P	C03007-T08P	-	R1/4
1.062	1310	T08P-2	C03508-T15P	C03007-T08P	T15P-2D	R1/4
1.299	1310	T15P-2D	C03508-T15P	C02506-T08P	C02506-T08P	R1/4
1.614-1.850	1310	T15P-2D	C04011-T15P	C04011-T15P	-	R1/4

Accessori

Per punta diametro (pollici)	Bit	Chiave dinamometrica
0.591-0.748	-	T00-07P09
0.866	-	T00-08P12
1.062	T00-15P	T00-15P30
1.299	-	T00-15P30
1.614-1.850	-	T00-15P30

SD572

Profondità di foratura ~ 2 x D – Misure metriche

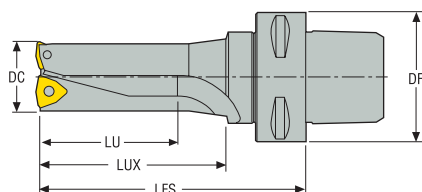



- Codolo C5 Seco-Capto™
- Adduzione refrigerante interna
- Per le informazioni sugli inserti, vedere pagina(e) 297-303
- Per i parametri di taglio raccomandati, vedere pagina(e) 314-315
- Per i diametri intermedi, utilizzare MyDesign.

Codice di ordinazione	Codice prodotto	Diam. foro min-max	DC	LU	LUX	LFS	DF	Inserto	
								Inserto centrale	Inserto periferico
		mm	mm	mm	mm	mm	mm		
SD572-15-30-C5	02595831	14,8 -18	15,0	30,0	35,0	85,0	50,0	WCMX030208-86	WCMX030208..
SD572-16-32-C5	02595832	15,8 -18	16,0	32,0	37,0	87,0	50,0	WCMX030208-86	WCMX030208..
SD572-17-34-C5	02595833	16,8 -19	17,0	34,0	39,0	89,0	50,0	WCMX030208-86	WCMX030208..
SD572-19-38-C5	02595834	18,8 -22	19,0	38,0	43,0	93,0	50,0	WCMX040208-86	WCMX030208..
SD572-22-44-C5	02595835	21,8 -27	22,0	44,0	49,0	99,0	50,0	WCMX050308-86	WCMX040208..
SD572-27-54-C5	02595836	26,8 -33	27,0	54,0	59,0	109,0	50,0	WCMX06T308-86	WCMX050308..
SD572-33-66-C5	02595837	32,8 -41	33,0	66,0	71,0	121,0	50,0	WCMX080412-86	WCMX06T308..
SD572-41-82-C5	02595838	40,8 -47	41,0	82,0	87,0	157,0	50,0	WCMX080412-86	WCMX080412..
SD572-47-94-C5	02595839	46,8 -52	47,0	94,0	99,0	169,0	50,0	WCMX080412-86	WCMX080412..

Parti di ricambio, comprese nella fornitura

Per punta diametro (mm)	Vite di bloccaggio inserto		Chiave per vite inserto	Grano	Adattatore
	Inserto centrale	Inserto periferico			
15,00-20,50	C02205-T07P	C02205-T07P	T07P-2	R1/4	1310
20,51-24,50	C03007-T08P	C02506-T08P	T08P-2	R1/4	1310
24,51-32,50	C03508-T15P	C03007-T08P	T08P-2, T15P-2D	R1/4	1310
32,51-36,50	C03508-T15P	C03508-T15P	T15P-2D	R1/4	1310
36,51-59,00	C04011-T15P	C04011-T15P	T15P-2D	R1/4	1310

Accessori

Per punta diametro (mm)	Chiave dinamometrica*	Bit sostituibile	Valore di coppia
15,00-20,50	 T00-07P09	 T00-07P	0,9 Nm
20,51-24,50	T00-08P12	T00-08P	1,2 Nm
24,51-32,50	T00-08P12	T00-08P	1,2 Nm
32,51-36,50	T00-15P30	T00-15P	3,0 Nm
36,51-59,00	T00-15P30	T00-15P	3,0 Nm

*Lama inclusa.

Introduzione

Foratura

Alesatura

Barenatura

Allegato



Perfomax® SD602

Perfomax® SD602 di Seco è un sistema di testine di foratura modulari, progettato specificamente per lavorare in modo sicuro ed efficiente fori profondi e di grandi diametri.

- Gli inserti di qualità DP3000 offrono la robustezza necessaria per ottimizzare Perfomax® SD602
- La qualità consente velocità e avanzamenti elevati
- Elevata flessibilità grazie all'uso delle prolunghie che consentono di raggiungere la profondità di foratura richiesta

Chiavi di codifica

Corpi punta

Introduzione



Punta pilota

Foratura

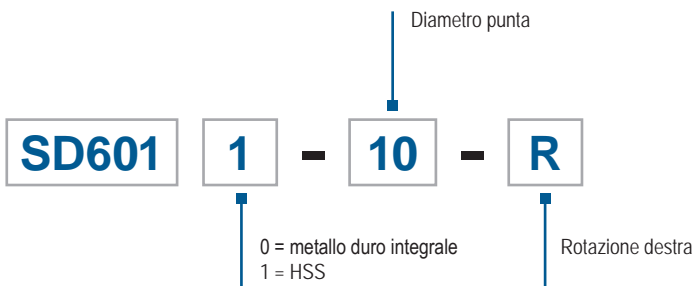

(La punta pilota deve essere acquistata separatamente)

Modulo

Alesatura

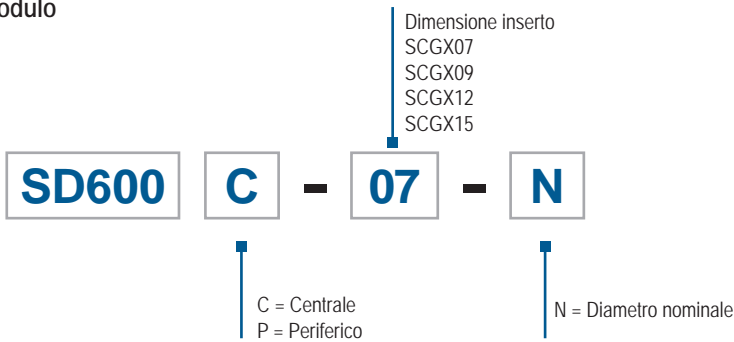

-N



-U

Kit

Barenatura

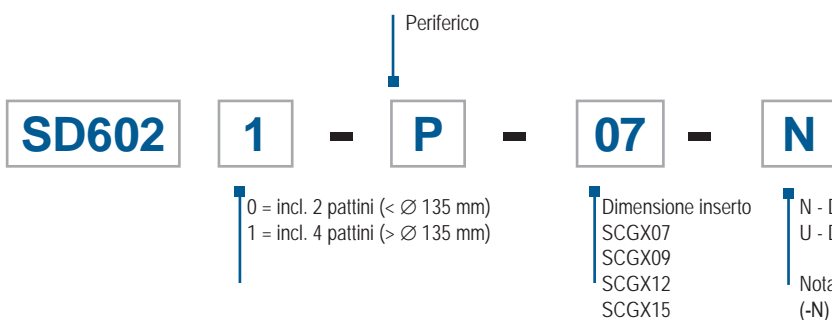

-N



-U

Nota: Selezionare il kit di parti di ricambio "D" con diametro nominale (-N) o inferiore (-U) a pagina 291 per completare il montaggio del corpo punta. Il kit "D" deve essere ordinato separatamente.

Pollici



Pattino

Allegato

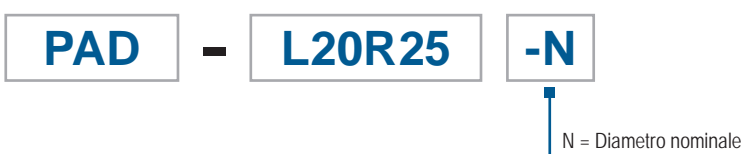

Testina di foratura modulare, componenti

SD602-59/60-40RG



Esempio: Diametro 59; SD602-59-40RG
Utilizzare il kit: SD6020-P07*



Esempio: Diametro 60; SD602-60-40RG
Utilizzare il kit: SD6020-P07-N*

Istruzioni di montaggio

Montaggio della cartuccia e del pattino di guida

- Serrare la vite di bloccaggio del modulo
- Montare gli inserti
- Montare la punta pilota e fissarla al fondo del foro; per estrarre ulteriormente la punta pilota usare la vite di regolazione
- Montare le prolunghe

- Montare il modulo
- Verificare che non vi siano interstizi tra il modulo e le pareti
- Serrare la vite di bloccaggio del modulo con la chiave dinamometrica:
SD600-x-07: 3 Nm
SD600-x-09: 3 Nm
SD600-x-12: 8 Nm
SD600-x-15: 8 Nm
- Montare il pattino di guida
- Serrare la vite di bloccaggio del pattino



* Non incluso nella fornitura. Kit periferico, punta pilota ed inserti devono essere ordinati separatamente.

SD602

Testa di foratura modulare – Misure metriche/Pollici

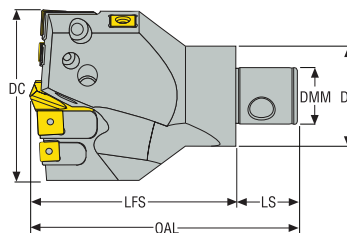

- Adduzione refrigerante interna
- Per le informazioni sugli inserti, vedere pagina(e) 297-303
- Per i parametri di taglio raccomandati, vedere pagina(e) 316-317
- Punta pilota regolabile

Codice di ordinazione	Codice prodotto	Dimensione Graflex	Capacità								Peso	Inserto
			DCN	DCX	OAL	LFS	LS	DF	DMM			
			mm Inch	mm Inch	mm Inch	mm Inch	mm Inch	mm Inch	mm Inch	mm Inch	kg lb	
SD602-59/60-40RG	02846688	G4	59,0 2.323	60,0 2.362	129,0 5.079	105,0 4.134	24,0 0.945	40,0 1.575	22,0 0.866	1,0 2.200	SCGX07	
SD602-69/70-40RG	02846689	G4	69,0 2.717	70,0 2.756	129,0 5.079	105,0 4.134	24,0 0.945	40,0 1.575	22,0 0.866	1,2 2.650	SCGX09	
SD602-79/80-50RG	02846690	G5	79,0 3.110	80,0 3.150	160,0 6.299	130,0 5.118	30,0 1.181	50,0 1.969	28,0 1.102	1,9 4.190	SCGX09	
SD602-89/90-50RG	02846691	G5	89,0 3.504	90,0 3.543	160,0 6.299	130,0 5.118	30,0 1.181	50,0 1.969	28,0 1.102	2,0 4.410	SCGX09/12	
SD602-99/100-63RG	02846692	G6	99,0 3.898	100,0 3.937	185,0 7.283	145,0 5.709	40,0 1.575	63,0 2.480	36,0 1.417	3,3 7.280	SCGX12	
SD602-119/120-63RG	02846693	G6	119,0 4.685	120,0 4.724	185,0 7.283	145,0 5.709	40,0 1.575	63,0 2.480	36,0 1.417	3,5 7.720	SCGX15	
SD602-139/140-90RG	02846694	G7	139,0 5.472	140,0 5.512	210,0 8.268	160,0 6.299	50,0 1.969	90,0 3.543	46,0 1.811	6,1 13.450	SCGX12	
SD602-159/160-90RG	02846695	G7	159,0 6.260	160,0 6.299	210,0 8.268	160,0 6.299	50,0 1.969	90,0 3.543	46,0 1.811	7,0 15.430	SCGX12/15	
SD602-2500-40RG	02846698	G4	62,5 2.461	63,5 2.500	129,0 5.079	105,0 4.134	24,0 0.945	40,0 1.575	22,0 0.866	1,0 2.200	SCGX07	
SD602-2750-40RG	02846699	G4	68,85 2.711	69,85 2.750	129,0 5.079	105,0 4.134	24,0 0.945	40,0 1.575	22,0 0.866	1,1 2.430	SCGX07/09	
SD602-3000-40RG	02846700	G4	75,2 2.961	76,2 3.000	129,0 5.079	105,0 4.134	24,0 0.945	40,0 1.575	22,0 0.866	1,3 2.870	SCGX09	
SD602-3250-50RG	02846701	G5	81,55 3.211	82,55 3.250	160,0 6.299	130,0 5.118	30,0 1.181	50,0 1.969	28,0 1.102	1,8 3.970	SCGX09/12	
SD602-3500-50RG	02846702	G5	87,9 3.461	88,9 3.500	160,0 6.299	130,0 5.118	30,0 1.181	50,0 1.969	28,0 1.102	2,1 4.630	SCGX09/12	
SD602-4000-63RG	02846703	G6	100,6 3.961	101,6 4.000	185,0 7.283	145,0 5.709	40,0 1.575	63,0 2.480	36,0 1.417	3,2 7.050	SCGX12	

Parti di ricambio, comprese nella fornitura

Modulo	Modulo	Vite di bloccaggio modulo	Rondella	Vite di bloccaggio inserto	Chiave per vite inserto	Pattino di guida*	Pattino di guida*	Vite pattino
SD600-C-07	SD600-P-07-N	K6S4x8	LW0408	C03007-T09P	T09P-2, T15P-2D	PAD-L20R25	PAD-L20R25-N	C04014-T15P
SD600-C-09	SD600-P-09-N	K6S4x8	LW0408	C03508-T15P	T15P-2D	PAD-L20R25	PAD-L20R25-N	C04014-T15P
SD600-C-12	SD600-P-12-N	K6S6x10	LW0611	C05012-T15P	T15P-2D	PAD-L20R25	PAD-L20R25-N	C04014-T15P
SD600-C-15	SD600-P-15-N	K6S6x12	LW0611	C05012-T15P	T15P-2D	PAD-L20R25	PAD-L20R25-N	C04014-T15P

*Non incluso nella fornitura

SD602

Testa di foratura modulare

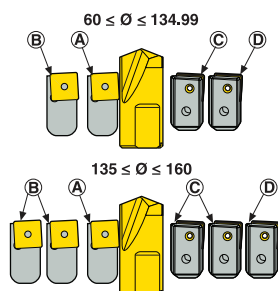
Parti di ricambio, comprese nella fornitura

Codice di ordinazione	Per punta diametro (mm)	Per punta diametro (pollici)	Vite pilota	Vite di regolazione	Modulo (A)	Modulo (B)	Modulo (C)	Kit Periferico* (D)	Punta pilota* x=0 Metallo duro x=1 HSS
SD602-59/60-40RG	59	2.323	P6SS 8X8	19TLR0816	SD600-C-07	SD600-C-07	SD600-P-07	SD6020-P-07-U	SD601x-10-R
SD602-59/60-40RG	60	2.362	P6SS 8X8	19TLR0816	SD600-C-07	SD600-C-07	SD600-P-07	SD6020-P-07-N	SD601x-10-R
SD602-2500-40RG	62,5	2.461	P6SS 8X8	19TLR0816	SD600-C-07	SD600-C-07	SD600-P-07	SD6020-P-07-U	SD601x-10-R
SD602-2500-40RG	63,5	2.500	P6SS 8X8	19TLR0816	SD600-C-07	SD600-C-07	SD600-P-07	SD6020-P-07-N	SD601x-10-R
SD602-2750-40RG	68,85	2.711	P6SS 8X8	19TLR0816	SD600-C-09	SD600-C-07	SD600-P-07	SD6020-P-07-U	SD601x-10-R
SD602-2750-40RG	69,85	2.750	P6SS 8X8	19TLR0816	SD600-C-09	SD600-C-07	SD600-P-07	SD6020-P-07-N	SD601x-10-R
SD602-69/70-40RG	69	2.717	P6SS 8X8	19TLR0816	SD600-C-09	SD600-C-09	SD600-P-09	SD6020-P-09-U	SD601x-10-R
SD602-69/70-40RG	70	2.756	P6SS 8X8	19TLR0816	SD600-C-09	SD600-C-09	SD600-P-09	SD6020-P-09-N	SD601x-10-R
SD602-3000-40RG	75,2	2.961	P6SS 10X10	19TLR1016	SD600-C-09	SD600-C-09	SD600-P-09	SD6020-P-09-U	SD601x-15-R
SD602-3000-40RG	76,2	3.000	P6SS 10X10	19TLR1016	SD600-C-09	SD600-C-09	SD600-P-09	SD6020-P-09-N	SD601x-15-R
SD602-79/80-50RG	79	3.110	P6SS 10X10	19TLR1016	SD600-C-09	SD600-C-09	SD600-P-09	SD6020-P-09-U	SD601x-15-R
SD602-79/80-50RG	80	3.150	P6SS 10X10	19TLR1016	SD600-C-09	SD600-C-09	SD600-P-09	SD6020-P-09-N	SD601x-15-R
SD602-3250-50RG	81,55	3.211	P6SS 10X10	19TLR1016	SD600-C-12	SD600-C-09	SD600-P-09	SD6020-P-09-U	SD601x-15-R
SD602-3250-50RG	82,55	3.250	P6SS 10X10	19TLR1016	SD600-C-12	SD600-C-09	SD600-P-09	SD6020-P-09-N	SD601x-15-R
SD602-3500-50RG	87,9	3.461	P6SS 10X10	19TLR1016	SD600-C-12	SD600-C-09	SD600-P-09	SD6020-P-12-U	SD601x-15-R
SD602-3500-50RG	88,9	3.500	P6SS 10X10	19TLR1016	SD600-C-12	SD600-C-09	SD600-P-09	SD6020-P-12-N	SD601x-15-R
SD602-89/90-50RG	89	3.504	P6SS 10X10	19TLR1016	SD600-C-12	SD600-C-09	SD600-P-09	SD6020-P-12-U	SD601x-15-R
SD602-89/90-50RG	90	3.543	P6SS 10X10	19TLR1016	SD600-C-12	SD600-C-09	SD600-P-09	SD6020-P-12-N	SD601x-15-R
SD602-99/100-63RG	99	3.898	P6SS 10X10	19TLR1016	SD600-C-12	SD600-C-12	SD600-P-12	SD6020-P-12-U	SD601x-15-R
SD602-99/100-63RG	100	3.937	P6SS 10X10	19TLR1016	SD600-C-12	SD600-C-12	SD600-P-12	SD6020-P-12-N	SD601x-15-R
SD602-4000-63RG	100,6	3.961	P6SS 10X10	19TLR1016	SD600-C-12	SD600-C-12	SD600-P-12	SD6020-P-12-U	SD601x-15-R
SD602-4000-63RG	101,6	4.000	P6SS 10X10	19TLR1016	SD600-C-12	SD600-C-12	SD600-P-12	SD6020-P-12-N	SD601x-15-R
SD602-119/120-63RG	119	4.685	P6SS 10X10	19TLR1016	SD600-C-15	SD600-C-15	SD600-P-15	SD6020-P-15-U	SD601x-15-R
SD602-119/120-63RG	120	4.724	P6SS 10X10	19TLR1016	SD600-C-15	SD600-C-15	SD600-P-15	SD6020-P-15-N	SD601x-15-R
SD602-139/140-90RG	139	5.472	P6SS 12X12	19TLR1216	SD600-C-12	SD600-C-12	SD600-P-12	SD6021-P-12-U	SD601x-25-R
SD602-139/140-90RG	140	5.512	P6SS 12X12	19TLR1216	SD600-C-12	SD600-C-12	SD600-P-12	SD6021-P-12-N	SD601x-25-R
SD602-159/160-90RG	159	6.260	P6SS 12X12	19TLR1216	SD600-C-15	SD600-C-12	SD600-P-12	SD6021-P-15-U	SD601x-25-R
SD602-159/160-90RG	160	6.299	P6SS 12X12	19TLR1216	SD600-C-15	SD600-C-12	SD600-P-12	SD6021-P-15-N	SD601x-25-R

*Non incluso nella fornitura. Kit Periferico, U- Diametro inferiore, N- Diametro nominale.
Per la dimensione dell'inserto vedere le pagine 297-303

Istruzioni per la riaffilatura di SD602

Specifiche:

Specifiche della mola diamantata per riaffilatura:

Spoglia conica: mola forma 12A2 Dimensione grana D54 (figura 1).

Snocciolatura: mola forma 1A1 o 1V1 Dimensione grana D64-D46 (figure 2-3).

Smusso: mola forma 1A1 o 12A2 (figura 1).

Preparazione tagliente: fase negativa o spazzolatura (figura 2).

Importante:

- I taglienti devono essere uniformi su tutta la preparazione del tagliente.
- La preparazione dei taglienti deve essere applicata sull'intera lunghezza dei taglienti.

1. Angolo di punta

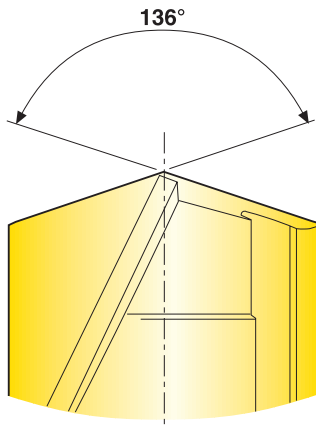

Preparazione del tagliente 0-0,1 mm (0-0,004") x 20°. Angolo di spoglia conico della punta 10°.

2. Smusso

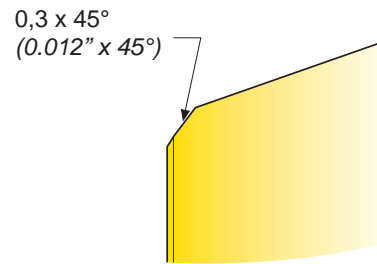

3.

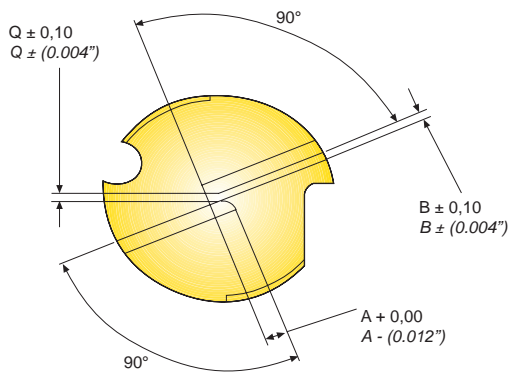

4.

Dimensioni in mm (pollici)

Diametro	A	B	C	Lunghezza minima
10 mm	1,5 (0.059)	0,5 (0.020)	0,57 (0.022)	38 (1.496)
15 mm	1,5 (0.059)	0,6 (0.024)	0,68 (0.027)	45 (1.772)
25 mm	1,5 (0.059)	1,4 (0.055)	1,6 (0.063)	57 (2.244)

Testina di foratura modulare, componenti

Caratteristica: Punta pilota regolabile

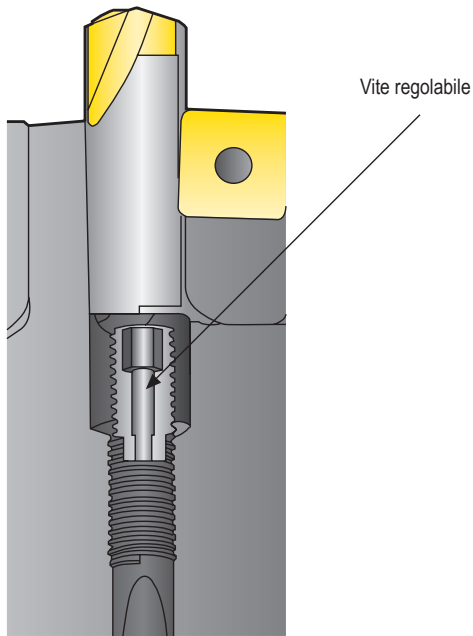

Campo di regolazione sporgenza punta pilota ADJRG

Punta	mm	pollici
SD602-59/60-40RG	3,0	0.118
SD602-69/70-40RG	3,0	0.118
SD602-79/80-50RG	5,0	0.197
SD602-89/90-50RG	5,0	0.197
SD602-99/100-63RG	5,0	0.197
SD602-119/120-63RG	5,0	0.197
SD602-139/140-90RG	5,0	0.197
SD602-159/160-90RG	5,0	0.197
SD602-2500-40RG	3,0	0.118
SD602-2750-40RG	3,0	0.118
SD602-3000-40RG	5,0	0.197
SD602-3250-50RG	5,0	0.197
SD602-3500-50RG	5,0	0.197
SD602-4000-63RG	5,0	0.197

Caratteristica: Campo di regolazione sporgenza punta pilota

Benefici: Stessa sporgenza dopo la riaffilatura della punta pilota.
 Possibilità di regolare la sporgenza della punta pilota.
 Con profondità di foratura $> 5 \times D$, si consiglia di estrarre la punta pilota di ulteriori 5 mm (0,197").
 Raccomandazioni: In caso di re-ingresso nel foro, la punta pilota deve essere estratta di ulteriori 3 mm (0,118") dalla sua posizione originale, per assicurare un centraggio migliore.

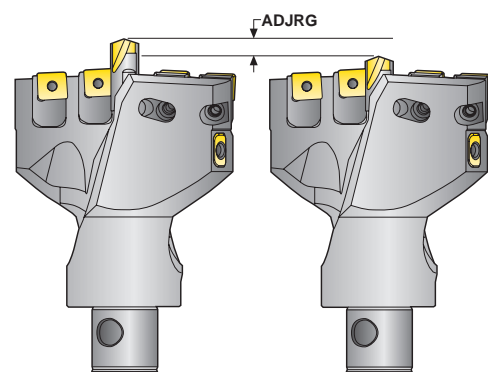

Testina di foratura modulare, componenti

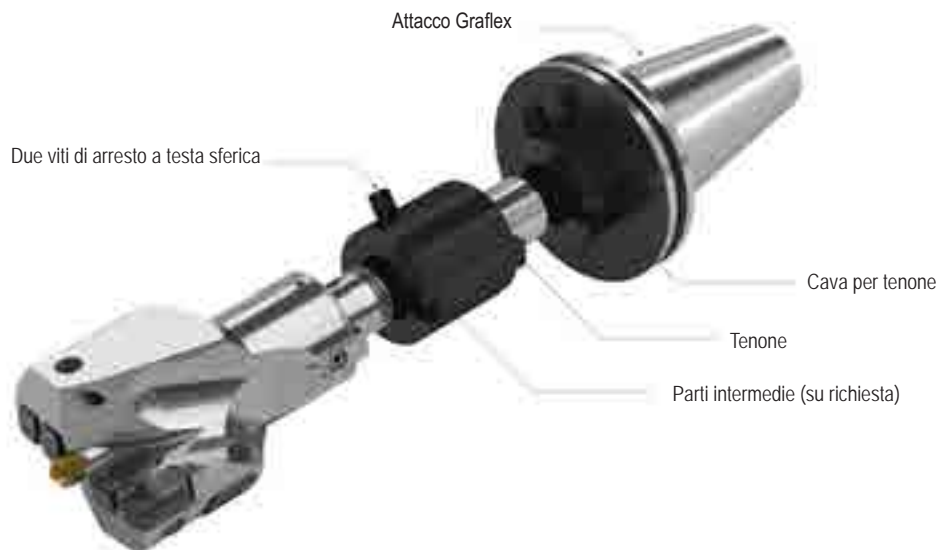

Istruzioni di montaggio

1. Pulire le due parti da assemblare ed applicare un prodotto antiossidante.
2. Assemblare le parti assicurandosi che il lato sinistro del tenone sia a contatto con la cava.
3. Serrare leggermente la vite A (le testine di foratura devono essere spostate avanti e indietro per trovare il punto più basso per la vite A).
4. Serrare leggermente la vite B.
5. 'Serrare' la vite di bloccaggio C.
6. 'Serrare' la vite A.
7. 'Serrare' la vite B.
8. Ricontrollare il serraggio della vite di bloccaggio.

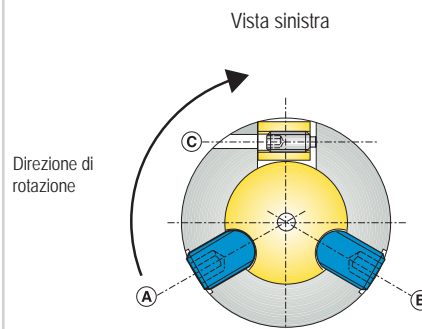
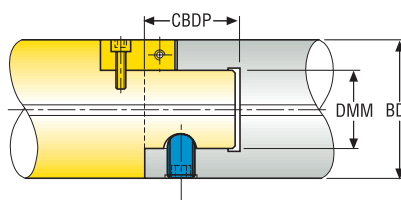

Coppie di serraggio raccomandate per la connessione Graflex

Dimensioni Graflex	DMM mm (pollici)	BD mm (pollici)	CBDP mm (pollici)	Viti a sfera (A) e (B)	Vite di bloccaggio tenone (C)
4	22 (0,866)	40 (1,575)	24 (0,945)	20 Nm (14,7 ft/lb)	0,7 Nm (0,5 ft/lb)
5	28 (1,102)	50 (1,969)	30 (1,181)	25 Nm (18,4 ft/lb)	2 Nm (1,5 ft/lb)
6	36 (1,417)	63 (2,480)	40 (1,575)	35 Nm (25,8 ft/lb)	4 Nm (2,9 ft/lb)
7	46 (1,811)	90 (3,543)	50 (1,969)	60 Nm (44,2 ft/lb)	8 Nm (5,9 ft/lb)



Qualità dell'inserto

Caratteristiche:

- 4 taglienti per inserto
- Robusti inserti quadri

Benefici:

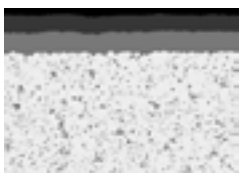
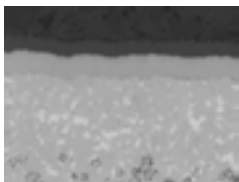
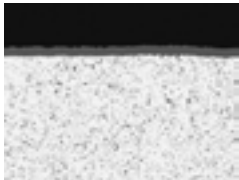
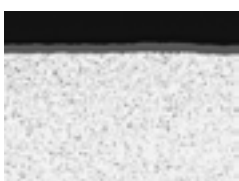
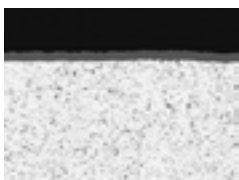
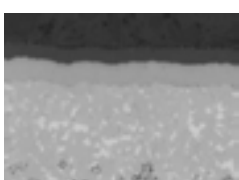
- Economia
- Affidabilità
- Produttività
- Basso costo per foro

Peripheral insert		
DP2000		<p>Tecnologia di rivestimento DURATOMIC®</p> <p>Qualità ottimizzata per la lavorazione di acciaio e ghisa</p> <p>Per lavorazioni con velocità di taglio molto elevate</p> <p>Ottima tenacità del tagliente ed elevata resistenza all'usura grazie all'elevato spessore del rivestimento Ti(C,N) + Al₂O₃ DURATOMIC®</p>
DP3000		<p>Tecnologia di rivestimento DURATOMIC®</p> <p>Qualità universale</p> <p>Resistenza all'usura e tenacità del tagliente eccellenti</p> <p>Qualità tenace per la massima sicurezza applicativa</p> <p>Ti(C,N) + Al₂O₃ DURATOMIC®</p> <p>Tenacità del substrato</p>
DS2050		<p>Qualità ottimizzata per titanio, super leghe e acciaio inossidabile di difficile lavorabilità con rivestimento PVD</p> <p>TiAlN + NbN</p>
T250D		<p>Prima scelta per acciaio temprato e alluminio ad alto contenuto di Si. Tagliente affilato grazie al substrato micrograna e al rivestimento pvd</p> <p>(TiAl)N + TiN</p>
Centro		
T400D		<p>Prima scelta</p> <p>Qualità dell'inserto centrale tenace per la massima sicurezza di applicazione</p> <p>Rivestimento PVD</p> <p>(Ti, Al)N + TiN</p>
DP3000		<p>Tecnologia di rivestimento DURATOMIC®</p> <p>Qualità universale</p> <p>Resistenza all'usura e tenacità del tagliente eccellenti</p> <p>Qualità tenace per la massima sicurezza applicativa</p> <p>Ti(C,N) + Al₂O₃ DURATOMIC®</p> <p>Tenacità del substrato</p>
DS4050		<p>Qualità ottimizzata per titanio, super leghe e acciaio inossidabile di difficile lavorabilità con rivestimento PVD</p> <p>TiAlN + NbN</p>

Geometrie



1. Forma inserto			2. Spoglia laterale inserto			4. Tipo																																																																			
						X = Speciale																																																																			
3. Tolleranze			5. Lunghezza del tagliente																																																																						
<table border="1"> <thead> <tr> <th rowspan="2">Toll. classe</th> <th colspan="3">Tolleranza +/- mm (pollici)</th> <th colspan="10">Per IC, dimensione in mm (pollici)</th> </tr> <tr> <th>m</th> <th>S</th> <th>IC</th> <th>5,556 (0.2187)</th> <th>6,35 (0.2500)</th> <th>7,937 (0.3125)</th> <th>7,94 (0.3126)</th> <th>9,525 (0.3750)</th> <th>11,509 (0.4531)</th> <th>12,7 (0.5000)</th> <th>15,875 (0.6250)</th> <th>19,05 (0.7500)</th> </tr> </thead> <tbody> <tr> <td>G</td> <td>0,025 (0.001)</td> <td>0,13 (0.005)</td> <td>0,025 (0.001)</td> <td>•</td> <td>•</td> <td>•</td> <td>•</td> <td>•</td> <td>•</td> <td>•</td> <td>•</td> <td>•</td> </tr> <tr> <td>M</td> <td>0,013 (0.005)</td> <td>0,13 (0.005)</td> <td>0,05 (0.002)</td> <td>•</td> <td>•</td> <td>•</td> <td>•</td> <td>•</td> <td>•</td> <td>•</td> <td>•</td> <td>•</td> </tr> <tr> <td>M</td> <td>0,013 (0.005)</td> <td>0,13 (0.005)</td> <td>0,08 (0.003)</td> <td></td> <td></td> <td></td> <td></td> <td></td> <td></td> <td>•</td> <td></td> <td></td> </tr> </tbody> </table>			Toll. classe	Tolleranza +/- mm (pollici)			Per IC, dimensione in mm (pollici)										m	S	IC	5,556 (0.2187)	6,35 (0.2500)	7,937 (0.3125)	7,94 (0.3126)	9,525 (0.3750)	11,509 (0.4531)	12,7 (0.5000)	15,875 (0.6250)	19,05 (0.7500)	G	0,025 (0.001)	0,13 (0.005)	0,025 (0.001)	•	•	•	•	•	•	•	•	•	M	0,013 (0.005)	0,13 (0.005)	0,05 (0.002)	•	•	•	•	•	•	•	•	•	M	0,013 (0.005)	0,13 (0.005)	0,08 (0.003)							•								
Toll. classe	Tolleranza +/- mm (pollici)			Per IC, dimensione in mm (pollici)																																																																					
	m	S	IC	5,556 (0.2187)	6,35 (0.2500)	7,937 (0.3125)	7,94 (0.3126)	9,525 (0.3750)	11,509 (0.4531)	12,7 (0.5000)	15,875 (0.6250)	19,05 (0.7500)																																																													
G	0,025 (0.001)	0,13 (0.005)	0,025 (0.001)	•	•	•	•	•	•	•	•	•																																																													
M	0,013 (0.005)	0,13 (0.005)	0,05 (0.002)	•	•	•	•	•	•	•	•	•																																																													
M	0,013 (0.005)	0,13 (0.005)	0,08 (0.003)							•																																																															
6. Spessore			7. Inserti con smusso/raggio di punta			10. Descrizione interna																																																																			
<p>02 = 2,38 mm (0.094") 03 = 3,18 mm (0.125") T3 = 3,97 mm (0.156")</p> <p>04 = 4,76 mm (0.187") 05 = 5,56 mm (0.219")</p>			<p>raggio di punta</p> <p>04 = 0,4 mm (0.016") 08 = 0,8 mm (0.031") 12 = 1,2 mm (0.047") ecc.</p>			<p>ad esempio, descrizione del formatrucciolo</p> <p>P1 = xx P2 = xx 85 = xx 86 = xx</p>																																																																			

Introduzione

Foratura

Alesatura

Barenatura

Allegato

Inserti sostituibili – Inserto periferico, tipo P1*

per SD522, SD523, SD524, SD525, SD542, SD602

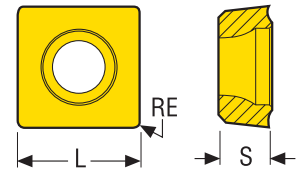
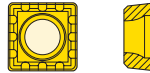
 Tolleranze:
 L = ±0,025 (0.001")
 S = ±0,13 (0.005")
 RE = ±0,1 (0.004")

SCGX-P1

Codice di ordinazione	Inserti	Dimensioni			Qualità		
		L mm Inch	S mm Inch	RE mm Inch	T250D	DP2000	DP3000
SCGX060204-P1	SCGX-P1	6,35 0,25	2,381 0,094	0,4 0,016	00059712	02590849	02807362
SCGX070308-P1	SCGX-P1	7,938 0,313	3,18 0,125	0,8 0,031	00059713	02590850	02807363
SCGX09T308-P1	SCGX-P1	9,525 0,375	3,969 0,156	0,8 0,031	00059714	02590851	02807364
SCGX11T308-P1	SCGX-P1	11,509 0,453	3,97 0,156	0,8 0,031	03136962	03136963	03136964
SCGX120408-P1	SCGX-P1	12,7 0,5	4,762 0,187	0,8 0,031	00059715	02590852	02807365
SCGX150512-P1	SCGX-P1	15,875 0,625	5,556 0,219	1,2 0,047	00059716	02590853	02807366

*Formatruolo per bassi avanzamenti e per una buona finitura superficiale in tutti i materiali da lavorare

Inserti sostituibili – Inserto periferico, tipo P2**

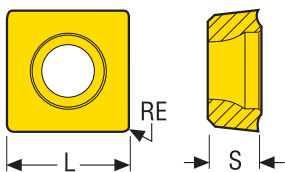
per SD522, SD523, SD524, SD525, SD542, SD602



Tolleranze:
L = ±0,025 (0.001")
S = ±0,13 (0.005")
RE = ±0,1 (0.004")

SCGX-P2



Codice di ordinazione	Inserti	L			S			RE		
		mm	Inch	mm	Inch	mm	Inch	T250D	DP2000	DP3000
SCGX050204-P2	SCGX-P2	5,556	0,219	2,38	0,094	0,4	0,016	00059711	02590854	02807356
SCGX060204-P2	SCGX-P2	6,35	0,25	2,38	0,094	0,4	0,016	02526803	02590855	02807357
SCGX070308-P2	SCGX-P2	7,937	0,312	3,18	0,125	0,8	0,031	02526787	02590856	02807358
SCGX09T308-P2	SCGX-P2	9,525	0,375	3,97	0,156	0,8	0,031	02794476	02590857	02807359
SCGX11T308-P2	SCGX-P2	11,509	0,453	3,97	0,156	0,8	0,031	03097760	03097761	03097762
SCGX120408-P2	SCGX-P2	12,7	0,5	4,76	0,187	0,8	0,031	02794477	02590858	02807360
SCGX150512-P2	SCGX-P2	15,875	0,625	5,56	0,219	1,2	0,047	02794478	02590859	02807361

**Formatruciolo per elevati avanzamenti su acciaio, acciaio inossidabile e ghisa

Introduzione

Foratura

Alesatura

Barenatura

Allegato

Inserti sostituibili – Inserto periferico, tipo MP

per SD522, SD523, SD524, SD525, SD542, SD602

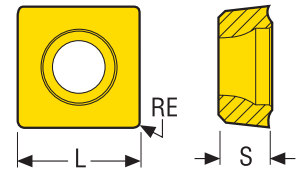
 Tolleranze:
 $L = \pm 0,025 (0.001")$
 $S = \pm 0,13 (0.005")$
 $RE = \pm 0,1 (0.004")$

SCGX-MP



Codice di ordinazione	Inserti	L		S		RE		Qualità
		mm	Inch	mm	Inch	mm	Inch	
SCGX050204-MP	SCGX-MP	5,56	0,219	2,38	0,094	0,4	0,016	03134312
SCGX060204-MP	SCGX-MP	6,35	0,25	6,35	0,25	0,4	0,016	03134313
SCGX070308-MP	SCGX-MP	7,94	0,313	3,18	0,125	0,8	0,031	03134314
SCGX09T308-MP	SCGX-MP	9,525	0,375	3,97	0,156	0,8	0,031	03134315
SCGX11T308-MP	SCGX-MP	11,509	0,453	3,97	0,156	0,8	0,031	03134316
SCGX120408-MP	SCGX-MP	12,7	0,5	4,76	0,187	0,8	0,031	03134317
SCGX150512-MP	SCGX-MP	15,875	0,625	5,56	0,219	1,2	0,047	03134318

Inserti sostituibili – Inserto centrale, tipo C1

per SD522, SD523, SD524, SD525, SD542

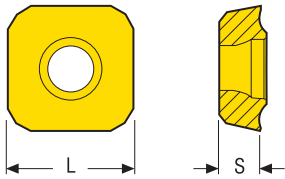

Tolleranze:
L = ±0,025 (0.001")
S = ±0,13 (0.005")

SPGX-C1



Codice di ordinazione	Inserti	L		S		Qualità	
		mm	Inch	mm	Inch	T400D	DP3000
SPGX0502-C1	SPGX-C1	5,556	0,219	2,38	0,094	74077370	02807367
SPGX0602-C1	SPGX-C1	6,35	0,25	2,38	0,094	74077371	02807368
SPGX0703-C1	SPGX-C1	7,937	0,312	3,18	0,125	74077372	02807369
SPGX0903-C1	SPGX-C1	9,525	0,375	3,18	0,125	74077373	02807370
SPGX11T3-C1	SPGX-C1	11,509	0,453	3,97	0,156	74077374	02807371
SPGX12T3-C1	SPGX-C1	12,7	0,5	3,97	0,156	74077375	02807372
SPGX1504-C1	SPGX-C1	15,875	0,625	4,76	0,187	74077376	02807373
SPGX1904-C1	SPGX-C1	19,05	0,75	4,76	0,187	74077377	02807374

Introduzione

Foratura

Alesatura

Barenatura

Allegato

Inserti sostituibili – Inserto centrale, tipo MC

per SD522, SD523, SD524, SD525, SD542

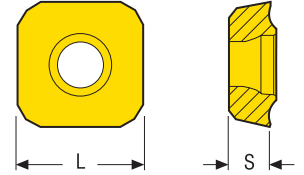
 Tolleranze:
 $L = \pm 0,025$ (0.001")
 $S = \pm 0,13$ (0.005")

SPGX-MC

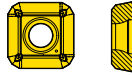

Codice di ordinazione	Inserti	L		S	Qualità
		mm	Inch		
					DS4050
SPGX0502-MC	SPGX-MC	5,56	0,219	2,38	03134319
SPGX0602-MC	SPGX-MC	6,35	0,25	2,38	03134320
SPGX0703-MC	SPGX-MC	7,94	0,313	3,18	03134321
SPGX0903-MC	SPGX-MC	9,525	0,375	3,18	03134322
SPGX11T3-MC	SPGX-MC	11,509	0,453	3,97	03134323
SPGX12T3-MC	SPGX-MC	12,7	0,5	3,97	03134324
SPGX1504-MC	SPGX-MC	15,875	0,625	4,76	03134325
SPGX1904-MC	SPGX-MC	19,05	0,75	4,76	03134326

Inserti sostituibili – Inserto periferico, tipo 85*

per SD572

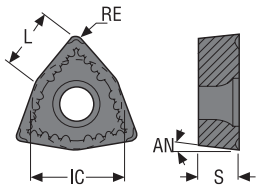

Tolleranze:
S = $\pm 0,13$ (0.005")
RE = $\pm 0,1$ (0.004")

WCMX-85

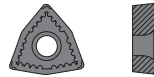

Codice di ordinazione	Inserti	IC	L	S	RE	Qualità
		mm Inch	mm Inch	mm Inch	mm Inch	
						DP3000
WCMX040208-85	WCMX-85	6,35 0,25	3,99 0,157	2,38 0,094	0,8 0,031	02807375
WCMX050308-85	WCMX-85	7,94 0,313	5,07 0,2	3,18 0,125	0,8 0,031	02807376
WCMX06T308-85	WCMX-85	9,525 0,375	6,14 0,242	3,97 0,156	0,8 0,031	02807377
WCMX080412-85	WCMX-85	12,7 0,5	8,14 0,32	4,76 0,187	1,2 0,047	02807378

**Formatrucciolo per elevati avanzamenti su acciaio, acciaio inossidabile e ghisa

Inserto centrale ed inserto periferico, formatruciolo 86**

per SD572

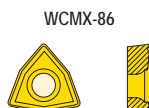
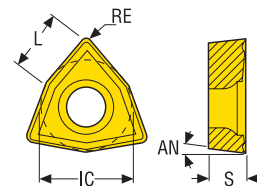
 Tolleranze:
 $S = \pm 0,13$ (0.005")
 $RE = \pm 0,1$ (0.004")

Codice di ordinazione	Inserti	IC	L	S	RE	Qualità		
						T400D	DP2000	DP3000
		mm Inch	mm Inch	mm Inch	mm Inch			
WCMX030208-86	WCMX-86	5,556 0,219	3,46 0,136	2,38 0,094	0,8 0,031	02506629	02899808	02807379
WCMX040208-86	WCMX-86	6,35 0,25	3,99 0,157	2,38 0,094	0,8 0,031	02506638	02899809	02807380
WCMX050308-86	WCMX-86	7,94 0,313	5,07 0,2	3,18 0,125	0,8 0,031	02506640	02899810	02807381
WCMX06T308-86	WCMX-86	9,525 0,375	6,14 0,242	3,97 0,156	0,8 0,031	02506645	02899811	02807382
WCMX080412-86	WCMX-86	12,7 0,5	8,14 0,32	4,76 0,187	1,2 0,047	02506646	02899812	02807383

**Formatruciolo per elevati avanzamenti su acciaio, acciaio inossidabile e ghisa

SD522 Ø 15-60 mm / 0.590-2.375 pollici

	SMG	f							V _c		
		Ø 15,00-19,49 Ø 0.590-0.767	Ø 19,50-22,49 Ø 0.768-0.885	Ø 22,50-28,49 Ø 0.886-1.121	Ø 28,50-34,49 Ø 1.122-1.357	Ø 34,50-40,49 Ø 1.358-1.593	Ø 40,49-44,49 Ø 1.594-1.751	Ø 44,50-59,99 Ø 1.752-2.375			
Introduzione	P1	P1 DP2000	0,060	0,070	0,085	0,095	0,11	0,12	0,13	460	
		P1 DP2000	0,0024	0,0028	0,0034	0,0038	0,0044	0,0048	0,0050	1500	
	P2	P1 DP2000	0,060	0,070	0,085	0,10	0,11	0,12	0,13	450	
		P1 DP2000	0,0024	0,0028	0,0034	0,0040	0,0044	0,0048	0,0050	1475	
	P3	P2 DP3000	0,12	0,14	0,17	0,19	0,22	0,22	0,26	345	
		P2 DP3000	0,0048	0,0055	0,0065	0,0075	0,0085	0,0085	0,010	1125	
	P4	P2 DP3000	0,12	0,13	0,16	0,19	0,22	0,22	0,25	220	
		P2 DP3000	0,0048	0,0050	0,0065	0,0075	0,0085	0,0085	0,010	720	
	P5	P2 DP3000	0,11	0,13	0,16	0,18	0,20	0,22	0,25	210	
		P2 DP3000	0,0044	0,0050	0,0065	0,0070	0,0080	0,0085	0,010	690	
	P6	P2 DP3000	0,11	0,13	0,16	0,18	0,20	0,22	0,25	235	
		P2 DP3000	0,0044	0,0050	0,0065	0,0070	0,0080	0,0085	0,010	770	
	P7	P2 DP3000	0,11	0,13	0,16	0,18	0,20	0,22	0,25	225	
		P2 DP3000	0,0044	0,0050	0,0065	0,0070	0,0080	0,0085	0,010	740	
	P8	P2 DP3000	0,12	0,14	0,17	0,19	0,22	0,22	0,26	210	
		P2 DP3000	0,0048	0,0055	0,0065	0,0075	0,0085	0,0085	0,010	690	
	P11	P2 DP3000	0,11	0,13	0,16	0,18	0,20	0,22	0,25	215	
		P2 DP3000	0,0044	0,0050	0,0065	0,0070	0,0080	0,0085	0,010	710	
P12	P2 DP3000	0,075	0,090	0,11	0,12	0,14	0,15	0,17	130		
	P2 DP3000	0,0030	0,0036	0,0044	0,0048	0,0055	0,0060	0,0065	425		
Foratura	M1	P2 DP3000	0,085	0,10	0,12	0,14	0,16	0,17	0,19	260	
		P2 DP3000	0,0034	0,0040	0,0048	0,0055	0,0065	0,0065	0,0075	850	
	M2	P2 DP3000	0,080	0,090	0,11	0,13	0,14	0,15	0,17	210	
		P2 DP3000	0,0032	0,0036	0,0044	0,0050	0,0055	0,0060	0,0065	690	
	M3	MP DS2050	0,065	0,075	0,090	0,10	0,12	0,13	0,14	160	
		MP DS2050	0,0026	0,0030	0,0036	0,0040	0,0048	0,0050	0,0055	520	
	M4	MP DS2050	0,055	0,065	0,080	0,090	0,10	0,11	0,12	140	
		MP DS2050	0,0022	0,0026	0,0032	0,0036	0,0040	0,0044	0,0048	460	
	M5	MP DS2050	0,055	0,065	0,080	0,090	0,10	0,11	0,12	115	
		MP DS2050	0,0022	0,0026	0,0032	0,0036	0,0040	0,0044	0,0048	375	
	Alesatura	K1	P2 DP2000	0,12	0,14	0,17	0,20	0,22	0,24	0,26	250
			P2 DP2000	0,0048	0,0055	0,0065	0,0080	0,0085	0,0095	0,010	820
		K2	P2 DP2000	0,11	0,13	0,16	0,18	0,20	0,22	0,24	215
			P2 DP2000	0,0044	0,0050	0,0065	0,0070	0,0080	0,0085	0,0095	710
		K3	P2 DP2000	0,11	0,13	0,16	0,18	0,20	0,22	0,24	185
			P2 DP2000	0,0044	0,0050	0,0065	0,0070	0,0080	0,0085	0,0095	610
		K4	P2 DP2000	0,11	0,13	0,16	0,18	0,20	0,22	0,24	175
			P2 DP2000	0,0044	0,0050	0,0065	0,0070	0,0080	0,0085	0,0095	570
K5		P2 DP2000	0,10	0,11	0,14	0,16	0,18	0,19	0,22	105	
		P2 DP2000	0,0040	0,0044	0,0055	0,0065	0,0070	0,0075	0,0085	345	
N11		N1	P1 T250D	0,12	0,14	0,17	0,20	0,22	0,24	0,26	365
			P1 T250D	0,0048	0,0055	0,0065	0,0080	0,0085	0,0095	0,010	1200
		N2	P1 T250D	0,12	0,14	0,17	0,20	0,22	0,24	0,26	235
			P1 T250D	0,0048	0,0055	0,0065	0,0080	0,0085	0,0095	0,010	770
		N3	P1 T250D	0,12	0,14	0,17	0,20	0,22	0,24	0,26	155
			P1 T250D	0,0048	0,0055	0,0065	0,0080	0,0085	0,0095	0,010	510
Barenatura		S1	P1 T250D	0,12	0,14	0,17	0,20	0,22	0,24	0,26	310
			P1 T250D	0,0048	0,0055	0,0065	0,0080	0,0085	0,0095	0,010	1025
	S2	MP DS2050	0,090	0,11	0,13	0,15	0,17	0,18	0,20	60	
		MP DS2050	0,0036	0,0044	0,0050	0,0060	0,0065	0,0070	0,0080	195	
	S3	MP DS2050	0,090	0,11	0,13	0,15	0,17	0,18	0,20	48	
		MP DS2050	0,0036	0,0044	0,0050	0,0060	0,0065	0,0070	0,0080	155	
	S11	MP DS2050	0,085	0,10	0,12	0,14	0,16	0,17	0,19	41	
		MP DS2050	0,0034	0,0040	0,0048	0,0055	0,0065	0,0065	0,0075	135	
	S12	MP DS2050	0,11	0,12	0,15	0,17	0,19	0,20	0,24	85	
		MP DS2050	0,0044	0,0048	0,0060	0,0065	0,0075	0,0080	0,0095	280	
	S13	MP DS2050	0,11	0,12	0,15	0,17	0,19	0,20	0,24	65	
		MP DS2050	0,0044	0,0048	0,0060	0,0065	0,0075	0,0080	0,0095	215	
	Allegato	H3	MP DS2050	0,090	0,11	0,13	0,15	0,17	0,18	0,20	50
			MP DS2050	0,0036	0,0044	0,0050	0,0060	0,0065	0,0070	0,0080	165
		H5	P1 T250D	0,050	0,060	0,070	0,080	0,095	0,10	0,11	70
			P1 T250D	0,0020	0,0024	0,0028	0,0032	0,0038	0,0040	0,0044	230
		H7	P1 T250D	0,075	0,090	0,11	0,12	0,14	0,15	0,17	130
			P1 T250D	0,0030	0,0036	0,0044	0,0048	0,0055	0,0060	0,0065	425
H8		P1 T250D	0,050	0,060	0,070	0,080	0,095	0,10	0,11	70	
		P1 T250D	0,0020	0,0024	0,0028	0,0032	0,0038	0,0040	0,0044	230	
H11		P1 T250D	0,060	0,070	0,085	0,095	0,11	0,11	0,13	130	
		P1 T250D	0,0024	0,0028	0,0034	0,0038	0,0044	0,0044	0,0050	425	
H12		P1 T250D	0,075	0,090	0,11	0,12	0,14	0,15	0,17	165	
		P1 T250D	0,0030	0,0036	0,0044	0,0048	0,0055	0,0060	0,0065	540	
H21		P1 T250D	0,060	0,070	0,085	0,095	0,11	0,11	0,13	150	
		P1 T250D	0,0024	0,0028	0,0034	0,0038	0,0044	0,0044	0,0050	490	
H21		P1 T250D	0,060	0,070	0,085	0,095	0,11	0,11	0,13	130	
		P1 T250D	0,0024	0,0028	0,0034	0,0038	0,0044	0,0044	0,0050	425	

SMG = Gruppo materiale Seco

f = mm/giro

v_c = m/min

Tutti i parametri di taglio sono valori di partenza

SMG	V _c			
	DP2000	DP3000	T250D	DS2050
P1	460	415	315	415
	1500	1350	1025	1350
P2	450	405	305	405
	1475	1325	1000	1325
P3	385	345	265	345
	1275	1125	870	1125
P4	285	220	140	—
	940	720	460	—
P5	270	210	135	—
	890	690	445	—
P6	305	235	150	—
	1000	770	490	—
P7	285	225	140	—
	940	740	460	—
P8	270	210	135	—
	890	690	445	—
P11	280	215	140	—
	920	710	460	—
P12	165	130	80	—
	540	425	260	—
M1	—	260	160	—
	—	850	520	—
M2	—	210	130	—
	—	690	425	—
M3	—	160	100	160
	—	520	330	520
M4	—	120	75	140
	—	395	245	460
M5	—	100	60	115
	—	330	195	375
K1	250	235	—	—
	820	770	—	—
K2	215	205	—	—
	710	670	—	—
K3	185	175	—	—
	610	570	—	—
K4	175	165	—	—
	570	540	—	—
K5	105	100	—	—
	345	330	—	—
N1	—	420	365	365
	—	1375	1200	1200
N2	—	270	235	235
	—	890	770	770
N3	—	180	155	155
	—	590	510	510
N11	—	350	310	310
	—	1150	1025	1025
S1	—	—	40	60
	—	—	130	195
S2	—	—	30	48
	—	—	100	155
S3	—	—	30	41
	—	—	100	135
S11	—	—	80	85
	—	—	260	280
S12	—	—	60	65
	—	—	195	215
S13	—	—	46	50
	—	—	150	165
H3	—	70	70	—
	—	230	230	—
H5	—	130	130	—
	—	425	425	—
H7	—	70	70	—
	—	230	230	—
H8	—	130	130	—
	—	425	425	—
H11	—	165	165	—
	—	540	540	—
H12	—	75	150	—
	—	245	490	—
H21	—	130	130	—
	—	425	425	—

SMG = gruppo materiale Seco V_c = m/min Tutti i parametri di taglio sono valori di partenza

Introduzione

Foratura

Alesatura

Barenatura

Allegato

Foratura
Perfomax® – Parametri di taglio



SD523 Ø 15-60 mm / 0.590-2.375 pollici

SMG		f							V _c
		Ø 15,00-19,49 Ø 0.590-0.767	Ø 19,50-22,49 Ø 0.768-0.885	Ø 22,50-28,49 Ø 0.886-1.121	Ø 28,50-34,49 Ø 1.122-1.357	Ø 34,50-40,49 Ø 1.358-1.593	Ø 40,49-44,49 Ø 1.594-1.751	Ø 44,50-59,99 Ø 1.752-2.375	
P1	P1 DP2000	0,060	0,070	0,085	0,095	0,11	0,12	0,13	415
	<i>P1 DP2000</i>	<i>0.0024</i>	<i>0.0028</i>	<i>0.0034</i>	<i>0.0038</i>	<i>0.0044</i>	<i>0.0048</i>	<i>0.0050</i>	1350
P2	P1 DP2000	0,060	0,070	0,085	0,10	0,11	0,12	0,13	405
	<i>P1 DP2000</i>	<i>0.0024</i>	<i>0.0028</i>	<i>0.0034</i>	<i>0.0040</i>	<i>0.0044</i>	<i>0.0048</i>	<i>0.0050</i>	1325
P3	P2 DP3000	0,12	0,14	0,17	0,19	0,22	0,22	0,26	310
	<i>P2 DP3000</i>	<i>0.0048</i>	<i>0.0055</i>	<i>0.0065</i>	<i>0.0075</i>	<i>0.0085</i>	<i>0.0085</i>	<i>0.010</i>	1025
P4	P2 DP3000	0,12	0,13	0,16	0,19	0,22	0,22	0,25	190
	<i>P2 DP3000</i>	<i>0.0048</i>	<i>0.0050</i>	<i>0.0065</i>	<i>0.0075</i>	<i>0.0085</i>	<i>0.0085</i>	<i>0.010</i>	620
P5	P2 DP3000	0,11	0,13	0,16	0,18	0,20	0,22	0,25	180
	<i>P2 DP3000</i>	<i>0.0044</i>	<i>0.0050</i>	<i>0.0065</i>	<i>0.0070</i>	<i>0.0080</i>	<i>0.0085</i>	<i>0.010</i>	590
P6	P2 DP3000	0,11	0,13	0,16	0,18	0,20	0,22	0,25	200
	<i>P2 DP3000</i>	<i>0.0044</i>	<i>0.0050</i>	<i>0.0065</i>	<i>0.0070</i>	<i>0.0080</i>	<i>0.0085</i>	<i>0.010</i>	660
P7	P2 DP3000	0,11	0,13	0,16	0,18	0,20	0,22	0,25	190
	<i>P2 DP3000</i>	<i>0.0044</i>	<i>0.0050</i>	<i>0.0065</i>	<i>0.0070</i>	<i>0.0080</i>	<i>0.0085</i>	<i>0.010</i>	620
P8	P2 DP3000	0,12	0,14	0,17	0,19	0,22	0,22	0,26	180
	<i>P2 DP3000</i>	<i>0.0048</i>	<i>0.0055</i>	<i>0.0065</i>	<i>0.0075</i>	<i>0.0085</i>	<i>0.0085</i>	<i>0.010</i>	590
P11	P2 DP3000	0,11	0,13	0,16	0,18	0,20	0,22	0,25	185
	<i>P2 DP3000</i>	<i>0.0044</i>	<i>0.0050</i>	<i>0.0065</i>	<i>0.0070</i>	<i>0.0080</i>	<i>0.0085</i>	<i>0.010</i>	610
P12	P2 DP3000	0,075	0,090	0,11	0,12	0,14	0,15	0,17	110
	<i>P2 DP3000</i>	<i>0.0030</i>	<i>0.0036</i>	<i>0.0044</i>	<i>0.0048</i>	<i>0.0055</i>	<i>0.0060</i>	<i>0.0065</i>	360
M1	P2 DP3000	0,085	0,10	0,12	0,14	0,16	0,17	0,19	245
	<i>P2 DP3000</i>	<i>0.0034</i>	<i>0.0040</i>	<i>0.0048</i>	<i>0.0055</i>	<i>0.0065</i>	<i>0.0065</i>	<i>0.0075</i>	800
M2	P2 DP3000	0,080	0,090	0,11	0,13	0,14	0,15	0,17	195
	<i>P2 DP3000</i>	<i>0.0032</i>	<i>0.0036</i>	<i>0.0044</i>	<i>0.0050</i>	<i>0.0055</i>	<i>0.0060</i>	<i>0.0065</i>	640
M3	MP DS2050	0,065	0,075	0,090	0,10	0,12	0,13	0,14	150
	<i>MP DS2050</i>	<i>0.0026</i>	<i>0.0030</i>	<i>0.0036</i>	<i>0.0040</i>	<i>0.0048</i>	<i>0.0050</i>	<i>0.0055</i>	490
M4	MP DS2050	0,055	0,065	0,080	0,090	0,10	0,11	0,12	120
	<i>MP DS2050</i>	<i>0.0022</i>	<i>0.0026</i>	<i>0.0032</i>	<i>0.0036</i>	<i>0.0040</i>	<i>0.0044</i>	<i>0.0048</i>	395
M5	MP DS2050	0,055	0,065	0,080	0,090	0,10	0,11	0,12	100
	<i>MP DS2050</i>	<i>0.0022</i>	<i>0.0026</i>	<i>0.0032</i>	<i>0.0036</i>	<i>0.0040</i>	<i>0.0044</i>	<i>0.0048</i>	330
K1	P2 DP2000	0,12	0,14	0,17	0,20	0,22	0,24	0,26	225
	<i>P2 DP2000</i>	<i>0.0048</i>	<i>0.0055</i>	<i>0.0065</i>	<i>0.0080</i>	<i>0.0085</i>	<i>0.0095</i>	<i>0.010</i>	740
K2	P2 DP2000	0,11	0,13	0,16	0,18	0,20	0,22	0,24	195
	<i>P2 DP2000</i>	<i>0.0044</i>	<i>0.0050</i>	<i>0.0065</i>	<i>0.0070</i>	<i>0.0080</i>	<i>0.0085</i>	<i>0.0095</i>	640
K3	P2 DP2000	0,11	0,13	0,16	0,18	0,20	0,22	0,24	165
	<i>P2 DP2000</i>	<i>0.0044</i>	<i>0.0050</i>	<i>0.0065</i>	<i>0.0070</i>	<i>0.0080</i>	<i>0.0085</i>	<i>0.0095</i>	540
K4	P2 DP2000	0,11	0,13	0,16	0,18	0,20	0,22	0,24	160
	<i>P2 DP2000</i>	<i>0.0044</i>	<i>0.0050</i>	<i>0.0065</i>	<i>0.0070</i>	<i>0.0080</i>	<i>0.0085</i>	<i>0.0095</i>	520
K5	P2 DP2000	0,10	0,11	0,14	0,16	0,18	0,19	0,22	95
	<i>P2 DP2000</i>	<i>0.0040</i>	<i>0.0044</i>	<i>0.0055</i>	<i>0.0065</i>	<i>0.0070</i>	<i>0.0075</i>	<i>0.0085</i>	310
N1	P1 T250D	0,12	0,14	0,17	0,20	0,22	0,24	0,26	310
	<i>P1 T250D</i>	<i>0.0048</i>	<i>0.0055</i>	<i>0.0065</i>	<i>0.0080</i>	<i>0.0085</i>	<i>0.0095</i>	<i>0.010</i>	1025
N2	P1 T250D	0,12	0,14	0,17	0,20	0,22	0,24	0,26	200
	<i>P1 T250D</i>	<i>0.0048</i>	<i>0.0055</i>	<i>0.0065</i>	<i>0.0080</i>	<i>0.0085</i>	<i>0.0095</i>	<i>0.010</i>	660
N3	P1 T250D	0,12	0,14	0,17	0,20	0,22	0,24	0,26	135
	<i>P1 T250D</i>	<i>0.0048</i>	<i>0.0055</i>	<i>0.0065</i>	<i>0.0080</i>	<i>0.0085</i>	<i>0.0095</i>	<i>0.010</i>	445
N11	P1 T250D	0,12	0,14	0,17	0,20	0,22	0,24	0,26	260
	<i>P1 T250D</i>	<i>0.0048</i>	<i>0.0055</i>	<i>0.0065</i>	<i>0.0080</i>	<i>0.0085</i>	<i>0.0095</i>	<i>0.010</i>	850
S1	MP DS2050	0,090	0,11	0,13	0,15	0,17	0,18	0,20	55
	<i>MP DS2050</i>	<i>0.0036</i>	<i>0.0044</i>	<i>0.0050</i>	<i>0.0060</i>	<i>0.0065</i>	<i>0.0070</i>	<i>0.0080</i>	180
S2	MP DS2050	0,090	0,11	0,13	0,15	0,17	0,18	0,20	43
	<i>MP DS2050</i>	<i>0.0036</i>	<i>0.0044</i>	<i>0.0050</i>	<i>0.0060</i>	<i>0.0065</i>	<i>0.0070</i>	<i>0.0080</i>	140
S3	MP DS2050	0,085	0,10	0,12	0,14	0,16	0,17	0,19	37
	<i>MP DS2050</i>	<i>0.0034</i>	<i>0.0040</i>	<i>0.0048</i>	<i>0.0055</i>	<i>0.0065</i>	<i>0.0065</i>	<i>0.0075</i>	120
S11	MP DS2050	0,11	0,12	0,15	0,17	0,19	0,20	0,24	75
	<i>MP DS2050</i>	<i>0.0044</i>	<i>0.0048</i>	<i>0.0060</i>	<i>0.0065</i>	<i>0.0075</i>	<i>0.0080</i>	<i>0.0095</i>	245
S12	MP DS2050	0,11	0,12	0,15	0,17	0,19	0,20	0,24	60
	<i>MP DS2050</i>	<i>0.0044</i>	<i>0.0048</i>	<i>0.0060</i>	<i>0.0065</i>	<i>0.0075</i>	<i>0.0080</i>	<i>0.0095</i>	195
S13	MP DS2050	0,090	0,11	0,13	0,15	0,17	0,18	0,20	45
	<i>MP DS2050</i>	<i>0.0036</i>	<i>0.0044</i>	<i>0.0050</i>	<i>0.0060</i>	<i>0.0065</i>	<i>0.0070</i>	<i>0.0080</i>	150
H3	P1 T250D	0,050	0,060	0,070	0,080	0,095	0,10	0,11	60
	<i>P1 T250D</i>	<i>0.0020</i>	<i>0.0024</i>	<i>0.0028</i>	<i>0.0032</i>	<i>0.0038</i>	<i>0.0040</i>	<i>0.0044</i>	195
H5	P1 T250D	0,075	0,090	0,11	0,12	0,14	0,15	0,17	110
	<i>P1 T250D</i>	<i>0.0030</i>	<i>0.0036</i>	<i>0.0044</i>	<i>0.0048</i>	<i>0.0055</i>	<i>0.0060</i>	<i>0.0065</i>	360
H7	P1 T250D	0,050	0,060	0,070	0,080	0,095	0,10	0,11	60
	<i>P1 T250D</i>	<i>0.0020</i>	<i>0.0024</i>	<i>0.0028</i>	<i>0.0032</i>	<i>0.0038</i>	<i>0.0040</i>	<i>0.0044</i>	195
H8	P1 T250D	0,060	0,070	0,085	0,095	0,11	0,11	0,13	110
	<i>P1 T250D</i>	<i>0.0024</i>	<i>0.0028</i>	<i>0.0034</i>	<i>0.0038</i>	<i>0.0044</i>	<i>0.0044</i>	<i>0.0050</i>	360
H11	P1 T250D	0,075	0,090	0,11	0,12	0,14	0,15	0,17	140
	<i>P1 T250D</i>	<i>0.0030</i>	<i>0.0036</i>	<i>0.0044</i>	<i>0.0048</i>	<i>0.0055</i>	<i>0.0060</i>	<i>0.0065</i>	460
H12	P1 T250D	0,060	0,070	0,085	0,095	0,11	0,11	0,13	130
	<i>P1 T250D</i>	<i>0.0024</i>	<i>0.0028</i>	<i>0.0034</i>	<i>0.0038</i>	<i>0.0044</i>	<i>0.0044</i>	<i>0.0050</i>	425
H21	P1 T250D	0,060	0,070	0,085	0,095	0,11	0,11	0,13	110
	<i>P1 T250D</i>	<i>0.0024</i>	<i>0.0028</i>	<i>0.0034</i>	<i>0.0038</i>	<i>0.0044</i>	<i>0.0044</i>	<i>0.0050</i>	360

SMG = Gruppo materiale Seco

f = mm/giro

V_c = m/min

Tutti i parametri di taglio sono valori di partenza

SMG	V _c			
	DP2000	DP3000	T250D	DS2050
P1	415	370	265	370
	1350	1225	870	1225
P2	405	360	260	360
	1325	1175	850	1175
P3	345	310	225	310
	1125	1025	740	1025
P4	230	190	120	—
	750	620	395	—
P5	220	180	115	—
	720	590	375	—
P6	250	200	130	—
	820	660	425	—
P7	235	190	120	—
	770	620	395	—
P8	220	180	115	—
	720	590	375	—
P11	225	185	115	—
	740	610	375	—
P12	135	110	70	—
	445	360	230	—
M1	—	245	135	—
	—	800	445	—
M2	—	195	110	—
	—	640	360	—
M3	—	150	85	150
	—	490	280	490
M4	—	115	65	120
	—	375	215	395
M5	—	95	55	100
	—	310	180	330
K1	225	215	—	—
	740	710	—	—
K2	195	185	—	—
	640	610	—	—
K3	165	160	—	—
	540	520	—	—
K4	160	150	—	—
	520	490	—	—
K5	95	90	—	—
	310	295	—	—
N1	—	360	310	310
	—	1175	1025	1025
N2	—	230	200	200
	—	750	660	660
N3	—	155	135	135
	—	510	445	445
N11	—	300	260	260
	—	980	850	850
S1	—	—	34	55
	—	—	110	180
S2	—	—	25	43
	—	—	80	140
S3	—	—	25	37
	—	—	80	120
S11	—	—	65	75
	—	—	215	245
S12	—	—	50	60
	—	—	165	195
S13	—	—	39	45
	—	—	130	150
H3	—	60	60	—
	—	195	195	—
H5	—	115	110	—
	—	375	360	—
H7	—	60	60	—
	—	195	195	—
H8	—	115	110	—
	—	375	360	—
H11	—	145	140	—
	—	475	460	—
H12	—	65	130	—
	—	215	425	—
H21	—	115	110	—
	—	375	360	—

SMG = gruppo materiale Seco V_c = m/min Tutti i parametri di taglio sono valori di partenza

Introduzione

Foratura

Alesatura

Barenatura

Allegato

Foratura
Perfomax® – Parametri di taglio



SD524 Ø 17-60 mm / 0.590-2.375 pollici

Introduzione

Foratura

Alesatura

Barenatura

Allegato

SMG	f								V _c
	Ø 15,00-19,49 Ø 0.590-0.767	Ø 19,50-22,49 Ø 0.768-0.885	Ø 22,50-28,49 Ø 0.886-1.121	Ø 28,50-34,49 Ø 1.122-1.357	Ø 34,50-40,49 Ø 1.358-1.593	Ø 40,49-44,49 Ø 1.594-1.751	Ø 44,50-59,99 Ø 1.752-2.375		
P1	P1 DP2000	0,060	0,070	0,085	0,095	0,11	0,12	0,13	380
	P1 DP2000	0,0024	0,0028	0,0034	0,0038	0,0044	0,0048	0,0050	1250
P2	P1 DP2000	0,060	0,070	0,085	0,10	0,11	0,12	0,13	370
	P1 DP2000	0,0024	0,0028	0,0034	0,0040	0,0044	0,0048	0,0050	1225
P3	P2 DP3000	0,12	0,14	0,17	0,19	0,22	0,22	0,26	285
	P2 DP3000	0,0048	0,0055	0,0065	0,0075	0,0085	0,0085	0,010	940
P4	P2 DP3000	0,12	0,13	0,16	0,19	0,22	0,22	0,25	165
	P2 DP3000	0,0048	0,0050	0,0065	0,0075	0,0085	0,0085	0,010	540
P5	P2 DP3000	0,11	0,13	0,16	0,18	0,20	0,22	0,25	160
	P2 DP3000	0,0044	0,0050	0,0065	0,0070	0,0080	0,0085	0,010	520
P6	P2 DP3000	0,11	0,13	0,16	0,18	0,20	0,22	0,25	180
	P2 DP3000	0,0044	0,0050	0,0065	0,0070	0,0080	0,0085	0,010	590
P7	P2 DP3000	0,11	0,13	0,16	0,18	0,20	0,22	0,25	170
	P2 DP3000	0,0044	0,0050	0,0065	0,0070	0,0080	0,0085	0,010	560
P8	P2 DP3000	0,12	0,14	0,17	0,19	0,22	0,22	0,26	160
	P2 DP3000	0,0048	0,0055	0,0065	0,0075	0,0085	0,0085	0,010	520
P11	P2 DP3000	0,11	0,13	0,16	0,18	0,20	0,22	0,25	165
	P2 DP3000	0,0044	0,0050	0,0065	0,0070	0,0080	0,0085	0,010	540
P12	P2 DP3000	0,075	0,090	0,11	0,12	0,14	0,15	0,17	95
	P2 DP3000	0,0030	0,0036	0,0044	0,0048	0,0055	0,0060	0,0065	310
M1	P2 DP3000	0,085	0,10	0,12	0,14	0,16	0,17	0,19	235
	P2 DP3000	0,0034	0,0040	0,0048	0,0055	0,0065	0,0065	0,0075	770
M2	P2 DP3000	0,080	0,090	0,11	0,13	0,14	0,15	0,17	190
	P2 DP3000	0,0032	0,0036	0,0044	0,0050	0,0055	0,0060	0,0065	620
M3	MP DS2050	0,065	0,075	0,090	0,10	0,12	0,13	0,14	145
	MP DS2050	0,0026	0,0030	0,0036	0,0040	0,0048	0,0050	0,0055	475
M4	MP DS2050	0,055	0,065	0,080	0,090	0,10	0,11	0,12	105
	MP DS2050	0,0022	0,0026	0,0032	0,0036	0,0040	0,0044	0,0048	345
M5	MP DS2050	0,055	0,065	0,080	0,090	0,10	0,11	0,12	90
	MP DS2050	0,0022	0,0026	0,0032	0,0036	0,0040	0,0044	0,0048	295
K1	P2 DP2000	0,12	0,14	0,17	0,20	0,22	0,24	0,26	210
	P2 DP2000	0,0048	0,0055	0,0065	0,0080	0,0085	0,0095	0,010	690
K2	P2 DP2000	0,11	0,13	0,16	0,18	0,20	0,22	0,24	180
	P2 DP2000	0,0044	0,0050	0,0065	0,0070	0,0080	0,0085	0,0095	590
K3	P2 DP2000	0,11	0,13	0,16	0,18	0,20	0,22	0,24	155
	P2 DP2000	0,0044	0,0050	0,0065	0,0070	0,0080	0,0085	0,0095	510
K4	P2 DP2000	0,11	0,13	0,16	0,18	0,20	0,22	0,24	145
	P2 DP2000	0,0044	0,0050	0,0065	0,0070	0,0080	0,0085	0,0095	475
K5	P2 DP2000	0,10	0,11	0,14	0,16	0,18	0,19	0,22	85
	P2 DP2000	0,0040	0,0044	0,0055	0,0065	0,0070	0,0075	0,0085	280
N1	P1 T250D	0,12	0,14	0,17	0,20	0,22	0,24	0,26	270
	P1 T250D	0,0048	0,0055	0,0065	0,0080	0,0085	0,0095	0,010	890
N2	P1 T250D	0,12	0,14	0,17	0,20	0,22	0,24	0,26	175
	P1 T250D	0,0048	0,0055	0,0065	0,0080	0,0085	0,0095	0,010	570
N3	P1 T250D	0,12	0,14	0,17	0,20	0,22	0,24	0,26	115
	P1 T250D	0,0048	0,0055	0,0065	0,0080	0,0085	0,0095	0,010	375
N11	P1 T250D	0,12	0,14	0,17	0,20	0,22	0,24	0,26	230
	P1 T250D	0,0048	0,0055	0,0065	0,0080	0,0085	0,0095	0,010	750
S1	MP DS2050	0,090	0,11	0,13	0,15	0,17	0,18	0,20	48
	MP DS2050	0,0036	0,0044	0,0050	0,0060	0,0065	0,0070	0,0080	155
S2	MP DS2050	0,090	0,11	0,13	0,15	0,17	0,18	0,20	39
	MP DS2050	0,0036	0,0044	0,0050	0,0060	0,0065	0,0070	0,0080	130
S3	MP DS2050	0,085	0,10	0,12	0,14	0,16	0,17	0,19	33
	MP DS2050	0,0034	0,0040	0,0048	0,0055	0,0065	0,0065	0,0075	110
S11	MP DS2050	0,11	0,12	0,15	0,17	0,19	0,20	0,24	70
	MP DS2050	0,0044	0,0048	0,0060	0,0065	0,0075	0,0080	0,0095	230
S12	MP DS2050	0,11	0,12	0,15	0,17	0,19	0,20	0,24	55
	MP DS2050	0,0044	0,0048	0,0060	0,0065	0,0075	0,0080	0,0095	180
S13	MP DS2050	0,090	0,11	0,13	0,15	0,17	0,18	0,20	41
	MP DS2050	0,0036	0,0044	0,0050	0,0060	0,0065	0,0070	0,0080	135
H3	P1 T250D	0,050	0,060	0,070	0,080	0,095	0,10	0,11	50
	P1 T250D	0,0020	0,0024	0,0028	0,0032	0,0038	0,0040	0,0044	165
H5	P1 T250D	0,075	0,090	0,11	0,12	0,14	0,15	0,17	95
	P1 T250D	0,0030	0,0036	0,0044	0,0048	0,0055	0,0060	0,0065	310
H7	P1 T250D	0,050	0,060	0,070	0,080	0,095	0,10	0,11	50
	P1 T250D	0,0020	0,0024	0,0028	0,0032	0,0038	0,0040	0,0044	165
H8	P1 T250D	0,060	0,070	0,085	0,095	0,11	0,11	0,13	95
	P1 T250D	0,0024	0,0028	0,0034	0,0038	0,0044	0,0044	0,0050	310
H11	P1 T250D	0,075	0,090	0,11	0,12	0,14	0,15	0,17	125
	P1 T250D	0,0030	0,0036	0,0044	0,0048	0,0055	0,0060	0,0065	410
H12	P1 T250D	0,060	0,070	0,085	0,095	0,11	0,11	0,13	110
	P1 T250D	0,0024	0,0028	0,0034	0,0038	0,0044	0,0044	0,0050	360
H21	P1 T250D	0,060	0,070	0,085	0,095	0,11	0,11	0,13	95
	P1 T250D	0,0024	0,0028	0,0034	0,0038	0,0044	0,0044	0,0050	310

SMG = Gruppo materiale Seco
f = mm/giro
v_c = m/min
Tutti i parametri di taglio sono valori di partenza

SMG	V _c			
	DP2000	DP3000	T250D	DS2050
P1	380	340	230	340
	1250	1125	750	1125
P2	370	330	225	330
	1225	1075	740	1075
P3	320	285	195	285
	1050	940	640	940
P4	195	165	105	—
	640	540	345	—
P5	185	160	100	—
	610	520	330	—
P6	210	180	110	—
	690	590	360	—
P7	195	170	105	—
	640	560	345	—
P8	185	160	100	—
	610	520	330	—
P11	190	165	100	—
	620	540	330	—
P12	110	95	60	—
	360	310	195	—
M1	—	235	120	—
	—	770	395	—
M2	—	190	95	—
	—	620	310	—
M3	—	145	75	145
	—	475	245	475
M4	—	110	55	105
	—	360	180	345
M5	—	90	46	90
	—	295	150	295
K1	210	200	—	—
	690	660	—	—
K2	180	170	—	—
	590	560	—	—
K3	155	145	—	—
	510	475	—	—
K4	145	140	—	—
	475	460	—	—
K5	85	85	—	—
	280	280	—	—
N1	—	315	270	270
	—	1025	890	890
N2	—	205	175	175
	—	670	570	570
N3	—	135	115	115
	—	445	375	375
N11	—	265	230	230
	—	870	750	750
S1	—	—	29	48
	—	—	95	155
S2	—	—	22	39
	—	—	70	130
S3	—	—	22	33
	—	—	70	110
S11	—	—	55	70
	—	—	180	230
S12	—	—	44	55
	—	—	145	180
S13	—	—	34	41
	—	—	110	135
H3	—	55	50	—
	—	180	165	—
H5	—	100	95	—
	—	330	310	—
H7	—	55	50	—
	—	180	165	—
H8	—	100	95	—
	—	330	310	—
H11	—	125	125	—
	—	410	410	—
H12	—	55	110	—
	—	180	360	—
H21	—	100	95	—
	—	330	310	—

SMG = gruppo materiale Seco V_c = m/min Tutti i parametri di taglio sono valori di partenza

Introduzione

Foratura

Alesatura

Barenatura

Allegato

SD525 Ø 19-45 mm / 0.768-2.000 pollici

	SMG	f					V _c	
		Ø 19,50-22,49 Ø 0.768-0.885	Ø 22,50-28,49 Ø 0.886-1.121	Ø 28,50-34,49 Ø 1.122-1.357	Ø 34,50-40,49 Ø 1.358-1.593	Ø 40,49-45,00 Ø 1.594-2.000		
Introduzione	P1	P2 DP3000 P2 DP3000	0,070 0.0028	0,085 0.0034	0,095 0.0038	0,11 0.0044	0,12 0.0048	320 1050
	P2	P2 DP3000 P2 DP3000	0,070 0.0028	0,085 0.0034	0,10 0.0040	0,11 0.0044	0,12 0.0048	310 1025
	P3	P2 DP3000 P2 DP3000	0,14 0.0055	0,17 0.0065	0,19 0.0075	0,22 0.0085	0,22 0.0085	265 870
	P4	P2 DP3000 P2 DP3000	0,13 0.0050	0,16 0.0065	0,19 0.0075	0,22 0.0085	0,22 0.0085	150 490
	P5	P2 DP3000 P2 DP3000	0,13 0.0050	0,16 0.0065	0,18 0.0070	0,20 0.0080	0,22 0.0085	140 460
	P6	P2 DP3000 P2 DP3000	0,13 0.0050	0,16 0.0065	0,18 0.0070	0,20 0.0080	0,22 0.0085	160 520
Foratura	P7	P2 DP3000 P2 DP3000	0,13 0.0050	0,16 0.0065	0,18 0.0070	0,20 0.0080	0,22 0.0085	150 490
	P8	P2 DP3000 P2 DP3000	0,14 0.0055	0,17 0.0065	0,19 0.0075	0,22 0.0085	0,22 0.0085	140 460
	P11	P2 DP3000 P2 DP3000	0,13 0.0050	0,16 0.0065	0,18 0.0070	0,20 0.0080	0,22 0.0085	145 475
	P12	P2 DP3000 P2 DP3000	0,090 0.0036	0,11 0.0044	0,12 0.0048	0,14 0.0055	0,15 0.0060	85 280
	M1	P2 DP3000 P2 DP3000	0,10 0.0040	0,12 0.0048	0,14 0.0055	0,16 0.0065	0,17 0.0065	225 740
	M2	P2 DP3000 P2 DP3000	0,090 0.0036	0,11 0.0044	0,13 0.0050	0,14 0.0055	0,15 0.0060	180 590
	M3	MP DS2050 MP DS2050	0,075 0.0030	0,090 0.0036	0,10 0.0040	0,12 0.0048	0,13 0.0050	140 460
	M4	MP DS2050 MP DS2050	0,065 0.0026	0,080 0.0032	0,090 0.0036	0,10 0.0040	0,11 0.0044	95 310
	M5	MP DS2050 MP DS2050	0,065 0.0026	0,080 0.0032	0,090 0.0036	0,10 0.0040	0,11 0.0044	80 260
	K1	P2 DP3000 P2 DP3000	0,14 0.0055	0,17 0.0065	0,20 0.0080	0,22 0.0085	0,24 0.0095	185 610
	K2	P2 DP3000 P2 DP3000	0,13 0.0050	0,16 0.0065	0,18 0.0070	0,20 0.0080	0,22 0.0085	160 520
	K3	P2 DP3000 P2 DP3000	0,13 0.0050	0,16 0.0065	0,18 0.0070	0,20 0.0080	0,22 0.0085	135 445
Alesatura	K4	P2 DP3000 P2 DP3000	0,13 0.0050	0,16 0.0065	0,18 0.0070	0,20 0.0080	0,22 0.0085	130 425
	K5	P2 DP3000 P2 DP3000	0,11 0.0044	0,14 0.0055	0,16 0.0065	0,18 0.0070	0,19 0.0075	80 260
	N1	P1 T250D P1 T250D	0,14 0.0055	0,17 0.0065	0,20 0.0080	0,22 0.0085	0,24 0.0095	240 790
	N2	P1 T250D P1 T250D	0,14 0.0055	0,17 0.0065	0,20 0.0080	0,22 0.0085	0,24 0.0095	155 510
	N3	P1 T250D P1 T250D	0,14 0.0055	0,17 0.0065	0,20 0.0080	0,22 0.0085	0,24 0.0095	100 330
Barenatura	N11	P1 T250D P1 T250D	0,14 0.0055	0,17 0.0065	0,20 0.0080	0,22 0.0085	0,24 0.0095	200 660
	S1	MP DS2050 MP DS2050	0,11 0.0044	0,13 0.0050	0,15 0.0060	0,17 0.0065	0,18 0.0070	44 145
	S2	MP DS2050 MP DS2050	0,11 0.0044	0,13 0.0050	0,15 0.0060	0,17 0.0065	0,18 0.0070	36 120
	S3	MP DS2050 MP DS2050	0,10 0.0040	0,12 0.0048	0,14 0.0055	0,16 0.0065	0,17 0.0065	31 100
	S11	MP DS2050 MP DS2050	0,12 0.0048	0,15 0.0060	0,17 0.0065	0,19 0.0075	0,20 0.0080	65 215
	S12	MP DS2050 MP DS2050	0,12 0.0048	0,15 0.0060	0,17 0.0065	0,19 0.0075	0,20 0.0080	49 160
	S13	MP DS2050 MP DS2050	0,11 0.0044	0,13 0.0050	0,15 0.0060	0,17 0.0065	0,18 0.0070	38 125
Allegato	H3	P1 T250D P1 T250D	0,060 0.0024	0,070 0.0028	0,085 0.0034	0,095 0.0038	0,10 0.0040	46 150
	H5	P1 T250D P1 T250D	0,090 0.0036	0,11 0.0044	0,12 0.0048	0,14 0.0055	0,15 0.0060	85 280
	H7	P1 T250D P1 T250D	0,060 0.0024	0,070 0.0028	0,085 0.0034	0,095 0.0038	0,10 0.0040	46 150
	H8	P1 T250D P1 T250D	0,070 0.0028	0,085 0.0034	0,095 0.0038	0,11 0.0044	0,11 0.0044	85 280
	H11	P1 T250D P1 T250D	0,090 0.0036	0,11 0.0044	0,12 0.0048	0,14 0.0055	0,15 0.0060	110 360
	H12	P1 T250D P1 T250D	0,070 0.0028	0,085 0.0034	0,095 0.0038	0,11 0.0044	0,11 0.0044	100 330
	H21	P1 T250D P1 T250D	0,070 0.0028	0,085 0.0034	0,095 0.0038	0,11 0.0044	0,11 0.0044	85 280

SMG = Gruppo materiale Seco

f = mm/giro

v_c = m/min

Tutti i parametri di taglio sono valori di partenza

SMG	V _c			
	DP2000	DP3000	T250D	DS2050
P1	355	320	205	320
	1175	1050	670	1050
P2	345	310	200	310
	1125	1025	660	1025
P3	295	265	170	265
	970	870	560	870
P4	165	150	90	—
	540	490	295	—
P5	155	140	90	—
	510	460	295	—
P6	175	160	100	—
	570	520	330	—
P7	165	150	95	—
	540	490	310	—
P8	155	140	90	—
	510	460	295	—
P11	160	145	90	—
	520	475	295	—
P12	95	85	55	—
	310	280	180	—
M1	—	225	105	—
	—	740	345	—
M2	—	180	85	—
	—	590	280	—
M3	—	140	65	140
	—	460	215	460
M4	—	105	49	95
	—	345	160	310
M5	—	85	41	80
	—	280	135	260
K1	195	185	—	—
	640	610	—	—
K2	170	160	—	—
	560	520	—	—
K3	145	135	—	—
	475	445	—	—
K4	140	130	—	—
	460	425	—	—
K5	80	80	—	—
	260	260	—	—
N1	—	285	240	240
	—	940	790	790
N2	—	185	155	155
	—	610	510	510
N3	—	120	100	100
	—	395	330	330
N11	—	235	200	200
	—	770	660	660
S1	—	—	26	44
	—	—	85	145
S2	—	—	20	36
	—	—	65	120
S3	—	—	20	31
	—	—	65	100
S11	—	—	50	65
	—	—	165	215
S12	—	—	39	49
	—	—	130	160
S13	—	—	30	38
	—	—	100	125
H3	—	48	46	—
	—	155	150	—
H5	—	90	85	—
	—	295	280	—
H7	—	48	46	—
	—	155	150	—
H8	—	90	85	—
	—	295	280	—
H11	—	115	110	—
	—	375	360	—
H12	—	50	100	—
	—	165	330	—
H21	—	90	85	—
	—	295	280	—

SMG = gruppo materiale Seco V_c = m/min Tutti i parametri di taglio sono valori di partenza

Introduzione

Foratura

Alesatura

Barenatura

Allegato

SD542 Ø 60-85 mm / 2.250-3.500 pollici

SMG		f		V _c
		Ø 60,00-65,00 Ø 2.250-2.559	Ø 70,00-85,00 Ø 2.750-3.500	
P1	P2 DP3000	0,095	0,12	390
	<i>P2 DP3000</i>	<i>0.0038</i>	<i>0.0048</i>	1275
P2	P2 DP3000	0,10	0,12	380
	<i>P2 DP3000</i>	<i>0.0040</i>	<i>0.0048</i>	1250
P3	P2 DP3000	0,19	0,22	325
	<i>P2 DP3000</i>	<i>0.0075</i>	<i>0.0085</i>	1075
P4	P2 DP3000	0,19	0,22	205
	<i>P2 DP3000</i>	<i>0.0075</i>	<i>0.0085</i>	670
P5	P2 DP3000	0,18	0,22	195
	<i>P2 DP3000</i>	<i>0.0070</i>	<i>0.0085</i>	640
P6	P2 DP3000	0,18	0,22	220
	<i>P2 DP3000</i>	<i>0.0070</i>	<i>0.0085</i>	720
P7	P2 DP3000	0,18	0,22	205
	<i>P2 DP3000</i>	<i>0.0070</i>	<i>0.0085</i>	670
P8	P2 DP3000	0,19	0,22	195
	<i>P2 DP3000</i>	<i>0.0075</i>	<i>0.0085</i>	640
P11	P2 DP3000	0,18	0,22	200
	<i>P2 DP3000</i>	<i>0.0070</i>	<i>0.0085</i>	660
P12	P2 DP3000	0,12	0,15	120
	<i>P2 DP3000</i>	<i>0.0048</i>	<i>0.0060</i>	395
M1	P2 DP3000	0,14	0,17	250
	<i>P2 DP3000</i>	<i>0.0055</i>	<i>0.0065</i>	820
M2	P2 DP3000	0,13	0,15	205
	<i>P2 DP3000</i>	<i>0.0050</i>	<i>0.0060</i>	670
M3	P1 T250D	0,10	0,12	90
	<i>P1 T250D</i>	<i>0.0040</i>	<i>0.0048</i>	295
M4	P1 T250D	0,090	0,11	70
	<i>P1 T250D</i>	<i>0.0036</i>	<i>0.0044</i>	230
M5	P1 T250D	0,090	0,11	55
	<i>P1 T250D</i>	<i>0.0036</i>	<i>0.0044</i>	180
K1	P2 DP3000	0,20	0,24	225
	<i>P2 DP3000</i>	<i>0.0080</i>	<i>0.0095</i>	740
K2	P2 DP3000	0,18	0,22	195
	<i>P2 DP3000</i>	<i>0.0070</i>	<i>0.0085</i>	640
K3	P2 DP3000	0,18	0,22	165
	<i>P2 DP3000</i>	<i>0.0070</i>	<i>0.0085</i>	540
K4	P2 DP3000	0,18	0,22	160
	<i>P2 DP3000</i>	<i>0.0070</i>	<i>0.0085</i>	520
K5	P2 DP3000	0,16	0,19	95
	<i>P2 DP3000</i>	<i>0.0065</i>	<i>0.0075</i>	310
N1	P1 T250D	0,20	0,24	335
	<i>P1 T250D</i>	<i>0.0080</i>	<i>0.0095</i>	1100
N2	P1 T250D	0,20	0,24	215
	<i>P1 T250D</i>	<i>0.0080</i>	<i>0.0095</i>	710
N3	P1 T250D	0,20	0,24	145
	<i>P1 T250D</i>	<i>0.0080</i>	<i>0.0095</i>	475
N11	P1 T250D	0,20	0,24	285
	<i>P1 T250D</i>	<i>0.0080</i>	<i>0.0095</i>	940
S1	MP DS2050	0,15	0,18	55
	<i>MP DS2050</i>	<i>0.0060</i>	<i>0.0070</i>	180
S2	MP DS2050	0,15	0,18	45
	<i>MP DS2050</i>	<i>0.0060</i>	<i>0.0070</i>	150
S3	MP DS2050	0,14	0,17	39
	<i>MP DS2050</i>	<i>0.0055</i>	<i>0.0065</i>	130
S11	MP DS2050	0,17	0,20	80
	<i>MP DS2050</i>	<i>0.0065</i>	<i>0.0080</i>	260
S12	MP DS2050	0,17	0,20	60
	<i>MP DS2050</i>	<i>0.0065</i>	<i>0.0080</i>	195
S13	MP DS2050	0,15	0,18	48
	<i>MP DS2050</i>	<i>0.0060</i>	<i>0.0070</i>	155
H3	P1 T250D	0,080	0,10	65
	<i>P1 T250D</i>	<i>0.0032</i>	<i>0.0040</i>	215
H5	P1 T250D	0,12	0,15	120
	<i>P1 T250D</i>	<i>0.0048</i>	<i>0.0060</i>	395
H7	P1 T250D	0,080	0,10	65
	<i>P1 T250D</i>	<i>0.0032</i>	<i>0.0040</i>	215
H8	P1 T250D	0,095	0,11	120
	<i>P1 T250D</i>	<i>0.0038</i>	<i>0.0044</i>	395
H11	P1 T250D	0,12	0,15	155
	<i>P1 T250D</i>	<i>0.0048</i>	<i>0.0060</i>	510
H12	P1 T250D	0,095	0,11	140
	<i>P1 T250D</i>	<i>0.0038</i>	<i>0.0044</i>	460
H21	P1 T250D	0,095	0,11	120
	<i>P1 T250D</i>	<i>0.0038</i>	<i>0.0044</i>	395

SMG = Gruppo materiale Seco

f = mm/giro

v_c = m/min

Tutti i parametri di taglio sono valori di partenza

SMG	V _c			
	DP2000	DP3000	T250D	DS2050
P1	435	390	290	390
	1425	1275	950	1275
P2	425	380	280	380
	1400	1250	920	1250
P3	365	325	240	325
	1200	1075	790	1075
P4	255	205	130	—
	840	670	425	—
P5	245	195	125	—
	800	640	410	—
P6	275	220	140	—
	900	720	460	—
P7	260	205	130	—
	850	670	425	—
P8	245	195	125	—
	800	640	410	—
P11	250	200	125	—
	820	660	410	—
P12	150	120	75	—
	490	395	245	—
M1	—	250	150	—
	—	820	490	—
M2	—	205	120	—
	—	670	395	—
M3	—	155	90	155
	—	510	295	510
M4	—	115	70	130
	—	375	230	425
M5	—	95	55	105
	—	310	180	345
K1	235	225	—	—
	770	740	—	—
K2	205	195	—	—
	670	640	—	—
K3	175	165	—	—
	570	540	—	—
K4	165	160	—	—
	540	520	—	—
K5	100	95	—	—
	330	310	—	—
N1	—	390	335	335
	—	1275	1100	1100
N2	—	250	215	215
	—	820	710	710
N3	—	165	145	145
	—	540	475	475
N11	—	325	285	285
	—	1075	940	940
S1	—	—	37	55
	—	—	120	180
S2	—	—	27	45
	—	—	90	150
S3	—	—	27	39
	—	—	90	130
S11	—	—	70	80
	—	—	230	260
S12	—	—	55	60
	—	—	180	195
S13	—	—	43	48
	—	—	140	155
H3	—	65	65	—
	—	215	215	—
H5	—	120	120	—
	—	395	395	—
H7	—	65	65	—
	—	215	215	—
H8	—	120	120	—
	—	395	395	—
H11	—	155	155	—
	—	510	510	—
H12	—	70	140	—
	—	230	460	—
H21	—	120	120	—
	—	395	395	—

SMG = gruppo materiale Seco V_c = m/min Tutti i parametri di taglio sono valori di partenza

Introduzione

Foratura

Alesatura

Barenatura

Allegato

Foratura
Perfomax® – Parametri di taglio



SD572 Ø 15-52 mm / 0.590-2.0472 pollici

SMG	f							V _c
	Ø 15,00-17,00 Ø 0.590-0.669	Ø 18,00-20,00 Ø 0.670-0.787	Ø 21,00-24,00 Ø 0.788-0.944	Ø 25,00-32,00 Ø 0.945-1.259	Ø 33,00-36,00 Ø 1.260-1.417	Ø 37,00-52,00 Ø 1.418-1.850		
P1	85 DP3000	0,042	0,042	0,048	0,060	0,070	0,085	310
	85 DP3000	0.0017	0.0017	0.0019	0.0024	0.0028	0.0034	1025
P2	85 DP3000	0,042	0,042	0,050	0,060	0,070	0,085	305
	85 DP3000	0.0017	0.0017	0.0020	0.0024	0.0028	0.0034	1000
P3	86 DP3000	0,12	0,12	0,13	0,17	0,19	0,22	260
	86 DP3000	0.0048	0.0048	0.0050	0.0065	0.0075	0.0085	850
P4	86 DP3000	0,11	0,11	0,13	0,16	0,19	0,22	230
	86 DP3000	0.0044	0.0044	0.0050	0.0065	0.0075	0.0085	750
P5	86 DP3000	0,11	0,11	0,13	0,16	0,18	0,22	220
	86 DP3000	0.0044	0.0044	0.0050	0.0065	0.0070	0.0085	720
P6	86 DP3000	0,11	0,11	0,13	0,16	0,18	0,22	245
	86 DP3000	0.0044	0.0044	0.0050	0.0065	0.0070	0.0085	800
P7	86 DP3000	0,11	0,11	0,13	0,16	0,18	0,22	235
	86 DP3000	0.0044	0.0044	0.0050	0.0065	0.0070	0.0085	770
P8	86 DP3000	0,12	0,12	0,13	0,17	0,19	0,22	220
	86 DP3000	0.0048	0.0048	0.0050	0.0065	0.0075	0.0085	720
P11	86 DP3000	0,11	0,11	0,13	0,16	0,18	0,22	225
	86 DP3000	0.0044	0.0044	0.0050	0.0065	0.0070	0.0085	740
P12	86 DP3000	0,075	0,075	0,085	0,11	0,12	0,15	135
	86 DP3000	0.0030	0.0030	0.0034	0.0044	0.0048	0.0060	445
M1	86 DP3000	0,075	0,075	0,085	0,11	0,12	0,15	235
	86 DP3000	0.0030	0.0030	0.0034	0.0044	0.0048	0.0060	770
M2	86 DP3000	0,070	0,070	0,080	0,10	0,11	0,14	190
	86 DP3000	0.0028	0.0028	0.0032	0.0040	0.0044	0.0055	620
M3	85 DP3000	0,034	0,034	0,040	0,048	0,055	0,070	145
	85 DP3000	0.0013	0.0013	0.0016	0.0019	0.0022	0.0028	475
M4	85 DP3000	0,030	0,030	0,034	0,042	0,050	0,060	110
	85 DP3000	0.0012	0.0012	0.0013	0.0017	0.0020	0.0024	360
M5	85 DP3000	0,030	0,030	0,034	0,042	0,050	0,060	90
	85 DP3000	0.0012	0.0012	0.0013	0.0017	0.0020	0.0024	295
K1	86 DP3000	0,12	0,12	0,14	0,17	0,20	0,24	180
	86 DP3000	0.0048	0.0048	0.0055	0.0065	0.0080	0.0095	590
K2	86 DP3000	0,11	0,11	0,13	0,16	0,18	0,22	155
	86 DP3000	0.0044	0.0044	0.0050	0.0065	0.0070	0.0085	510
K3	86 DP3000	0,11	0,11	0,13	0,16	0,18	0,22	130
	86 DP3000	0.0044	0.0044	0.0050	0.0065	0.0070	0.0085	425
K4	86 DP3000	0,11	0,11	0,13	0,16	0,18	0,22	125
	86 DP3000	0.0044	0.0044	0.0050	0.0065	0.0070	0.0085	410
K5	86 DP3000	0,10	0,10	0,11	0,14	0,16	0,19	75
	86 DP3000	0.0040	0.0040	0.0044	0.0055	0.0065	0.0075	245
S1	85 DP3000	0,055	0,055	0,060	0,075	0,090	0,11	40
	85 DP3000	0.0022	0.0022	0.0024	0.0030	0.0036	0.0044	130
S2	85 DP3000	0,055	0,055	0,060	0,075	0,090	0,11	30
	85 DP3000	0.0022	0.0022	0.0024	0.0030	0.0036	0.0044	100
S3	85 DP3000	0,050	0,050	0,060	0,070	0,085	0,10	30
	85 DP3000	0.0020	0.0020	0.0024	0.0028	0.0034	0.0040	100
S11	85 DP3000	0,060	0,060	0,070	0,090	0,10	0,12	80
	85 DP3000	0.0024	0.0024	0.0028	0.0036	0.0040	0.0048	260
S12	85 DP3000	0,060	0,060	0,070	0,090	0,10	0,12	60
	85 DP3000	0.0024	0.0024	0.0028	0.0036	0.0040	0.0048	195
S13	85 DP3000	0,055	0,055	0,060	0,075	0,090	0,11	47
	85 DP3000	0.0022	0.0022	0.0024	0.0030	0.0036	0.0044	155
H3	86 DP3000	0,050	0,050	0,060	0,070	0,085	0,10	80
	86 DP3000	0.0020	0.0020	0.0024	0.0028	0.0034	0.0040	260
H5	86 DP3000	0,075	0,075	0,085	0,11	0,12	0,15	150
	86 DP3000	0.0030	0.0030	0.0034	0.0044	0.0048	0.0060	490
H7	86 DP3000	0,050	0,050	0,060	0,070	0,085	0,10	80
	86 DP3000	0.0020	0.0020	0.0024	0.0028	0.0034	0.0040	260
H8	86 DP3000	0,060	0,060	0,065	0,085	0,095	0,11	150
	86 DP3000	0.0024	0.0024	0.0026	0.0034	0.0038	0.0044	490
H11	86 DP3000	0,075	0,075	0,085	0,11	0,12	0,15	195
	86 DP3000	0.0030	0.0030	0.0034	0.0044	0.0048	0.0060	640
H12	86 DP3000	0,060	0,060	0,065	0,085	0,095	0,11	80
	86 DP3000	0.0024	0.0024	0.0026	0.0034	0.0038	0.0044	260
H21	86 DP3000	0,060	0,060	0,065	0,085	0,095	0,11	150
	86 DP3000	0.0024	0.0024	0.0026	0.0034	0.0038	0.0044	490

SMG = Gruppo materiale Seco

f = mm/giro

v_c = m/min

Tutti i parametri di taglio sono valori di partenza

Allegato

SMG	V _c	
	DP2000	
P1	375	
	1225	
P2	365	
	1200	
P3	315	
	1025	
P4	280	
	920	
P5	265	
	870	
P6	300	
	980	
P7	280	
	920	
P8	265	
	870	
P11	275	
	900	
P12	160	
	520	
M1	285	
	940	
M2	230	
	750	
M3	175	
	570	
M4	130	
	425	
M5	110	
	360	
K1	215	
	710	
K2	185	
	610	
K3	160	
	520	
K4	150	
	490	
K5	90	
	295	
S1	—	
	—	
S2	—	
	—	
S3	—	
	—	
S11	—	
	—	
S12	—	
	—	
S13	—	
	—	
H3	80	
	260	
H5	150	
	490	
H7	80	
	260	
H8	150	
	490	
H11	195	
	640	
H12	95	
	310	
H21	150	
	490	

SMG = gruppo materiale Seco V_c = m/min Tutti i parametri di taglio sono valori di partenza

Introduzione

Foratura

Alesatura

Barenatura

Allegato

SD602 Ø 60-160 mm / 2.362-6.300 pollici

SMG		f					V _c
		Ø 60,00-69,99 Ø 2.362-2.755	Ø 70,00-91,99 Ø 2.756-3.621	Ø 92,00-110,99 Ø 3.622-4.369	Ø 111,00-134,99 Ø 4.370-4.314	Ø 135,00-160,00 Ø 4.315-6.300	
P1	P2 DP3000	0,085	0,095	0,12	0,13	0,12	295
	P2 DP3000	0.0034	0.0038	0.0048	0.0050	0.0048	970
P2	P2 DP3000	0,085	0,10	0,12	0,13	0,12	285
	P2 DP3000	0.0034	0.0040	0.0048	0.0050	0.0048	940
P3	P2 DP3000	0,17	0,19	0,22	0,26	0,22	245
	P2 DP3000	0.0065	0.0075	0.0085	0.010	0.0085	800
P4	P2 DP3000	0,16	0,19	0,22	0,25	0,22	130
	P2 DP3000	0.0065	0.0075	0.0085	0.010	0.0085	425
P5	P2 DP3000	0,16	0,18	0,22	0,25	0,22	125
	P2 DP3000	0.0065	0.0070	0.0085	0.010	0.0085	410
P6	P2 DP3000	0,16	0,18	0,22	0,25	0,22	140
	P2 DP3000	0.0065	0.0070	0.0085	0.010	0.0085	460
P7	P2 DP3000	0,16	0,18	0,22	0,25	0,22	135
	P2 DP3000	0.0065	0.0070	0.0085	0.010	0.0085	445
P8	P2 DP3000	0,17	0,19	0,22	0,26	0,22	125
	P2 DP3000	0.0065	0.0075	0.0085	0.010	0.0085	410
P11	P2 DP3000	0,16	0,18	0,22	0,25	0,22	130
	P2 DP3000	0.0065	0.0070	0.0085	0.010	0.0085	425
P12	P2 DP3000	0,11	0,12	0,15	0,17	0,15	75
	P2 DP3000	0.0044	0.0048	0.0060	0.0065	0.0060	245
M1	P2 DP3000	0,12	0,14	0,17	0,19	0,17	215
	P2 DP3000	0.0048	0.0055	0.0065	0.0075	0.0065	710
M2	P2 DP3000	0,11	0,13	0,15	0,17	0,15	175
	P2 DP3000	0.0044	0.0050	0.0060	0.0065	0.0060	570
M3	P1 DP3000	0,090	0,10	0,12	0,14	0,12	135
	P1 DP3000	0.0036	0.0040	0.0048	0.0055	0.0048	445
M4	P1 DP3000	0,075	0,090	0,11	0,12	0,11	100
	P1 DP3000	0.0030	0.0036	0.0044	0.0048	0.0044	330
M5	P1 DP3000	0,075	0,090	0,11	0,12	0,11	85
	P1 DP3000	0.0030	0.0036	0.0044	0.0048	0.0044	280
K1	P2 DP3000	0,17	0,20	0,24	0,26	0,24	175
	P2 DP3000	0.0065	0.0080	0.0095	0.010	0.0095	570
K2	P2 DP3000	0,16	0,18	0,22	0,24	0,22	150
	P2 DP3000	0.0065	0.0070	0.0085	0.0095	0.0085	490
K3	P2 DP3000	0,16	0,18	0,22	0,24	0,22	130
	P2 DP3000	0.0065	0.0070	0.0085	0.0095	0.0085	425
K4	P2 DP3000	0,16	0,18	0,22	0,24	0,22	120
	P2 DP3000	0.0065	0.0070	0.0085	0.0095	0.0085	395
K5	P2 DP3000	0,14	0,16	0,19	0,22	0,19	75
	P2 DP3000	0.0055	0.0065	0.0075	0.0085	0.0075	245
H3	P2 DP3000	0,070	0,080	0,10	0,11	0,10	42
	P2 DP3000	0.0028	0.0032	0.0040	0.0044	0.0040	140
H5	P2 DP3000	0,11	0,12	0,15	0,17	0,15	80
	P2 DP3000	0.0044	0.0048	0.0060	0.0065	0.0060	260
H7	P2 DP3000	0,070	0,080	0,10	0,11	0,10	42
	P2 DP3000	0.0028	0.0032	0.0040	0.0044	0.0040	140
H8	P2 DP3000	0,085	0,095	0,11	0,13	0,11	80
	P2 DP3000	0.0034	0.0038	0.0044	0.0050	0.0044	260
H11	P2 DP3000	0,11	0,12	0,15	0,17	0,15	100
	P2 DP3000	0.0044	0.0048	0.0060	0.0065	0.0060	330
H12	P2 DP3000	0,085	0,095	0,11	0,13	0,11	45
	P2 DP3000	0.0034	0.0038	0.0044	0.0050	0.0044	150
H21	P2 DP3000	0,085	0,095	0,11	0,13	0,11	80
	P2 DP3000	0.0034	0.0038	0.0044	0.0050	0.0044	260

SMG = Gruppo materiale Seco

f = mm/giro

v_c = m/min

Tutti i parametri di taglio sono valori di partenza

SMG	V _c	
	T250D	DS2050
P1	180	295
	590	970
P2	175	285
	570	940
P3	150	245
	490	800
P4	80	—
	260	—
P5	75	—
	245	—
P6	85	—
	280	—
P7	80	—
	260	—
P8	75	—
	245	—
P11	80	—
	260	—
P12	46	—
	150	—
M1	90	—
	295	—
M2	75	—
	245	—
M3	55	135
	180	445
M4	43	85
	140	280
M5	36	70
	120	230
K1	—	—
	—	—
K2	—	—
	—	—
K3	—	—
	—	—
K4	—	—
	—	—
K5	—	—
	—	—
H3	40	—
	130	—
H5	75	—
	245	—
H7	40	—
	130	—
H8	75	—
	245	—
H11	95	—
	310	—
H12	85	—
	280	—
H21	75	—
	245	—

SMG = gruppo materiale Seco V_c = m/min Tutti i parametri di taglio sono valori di partenza

Introduzione

Foratura

Alesatura

Barenatura

Allegato

Parametri di lavorazione SD522, SD523, SD524, SD525, SD542 e SD572 - Grafici di potenza assorbita, portata refrigerante e forze applicate

I valori dei grafici variano in funzione dei parametri di taglio, dei materiali, dell'efficienza della macchina e dell'usura dell'utensile.

I grafici sono validi per foratura di materiali appartenenti ai gruppi Seco P5-P6 e per una velocità di taglio di 200 m/min (655 sf/min).

Forza di avanzamento

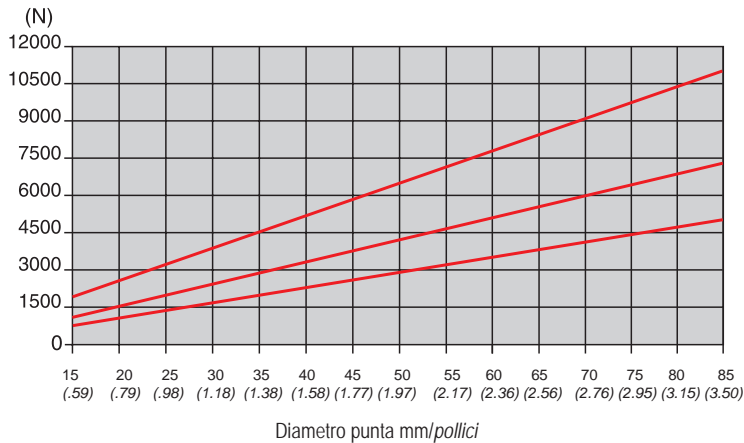

f = 0,18 mm/giro
(f = 0,007 pollici/giro)

f = 0,12 mm/giro
(f = 0,005 pollici/giro)

f = 0,08 mm/giro
(f = 0,003 pollici/giro)

Potenza assorbita

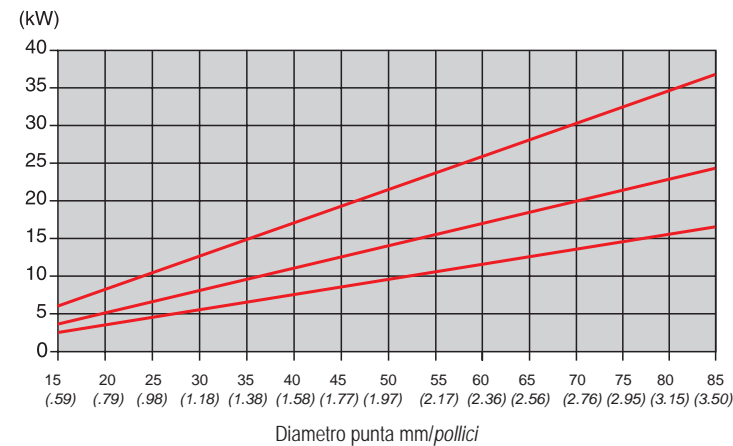

f = 0,18 mm/giro
(f = 0,007 pollici/giro)

f = 0,12 mm/giro
(f = 0,005 pollici/giro)

f = 0,08 mm/giro
(f = 0,003 pollici/giro)

Coppia applicata

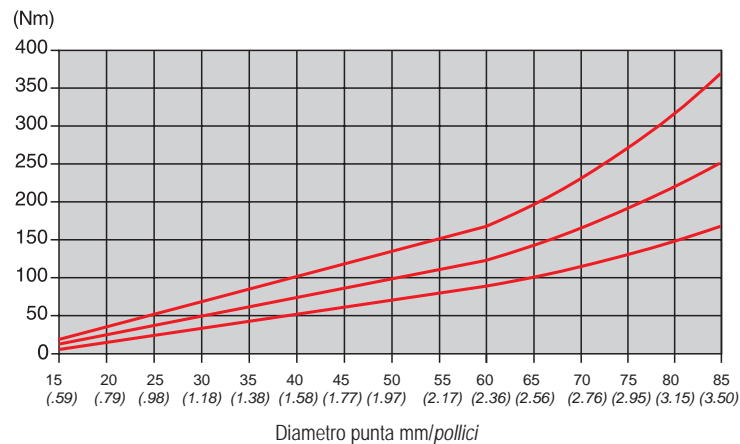

f = 0,18 mm/giro
(f = 0,007 pollici/giro)

f = 0,12 mm/giro
(f = 0,005 pollici/giro)

f = 0,08 mm/giro
(f = 0,003 pollici/giro)

Parametri di lavorazione

Requisiti del volume di refrigerante

Litri/minuto (galloni/minuto)

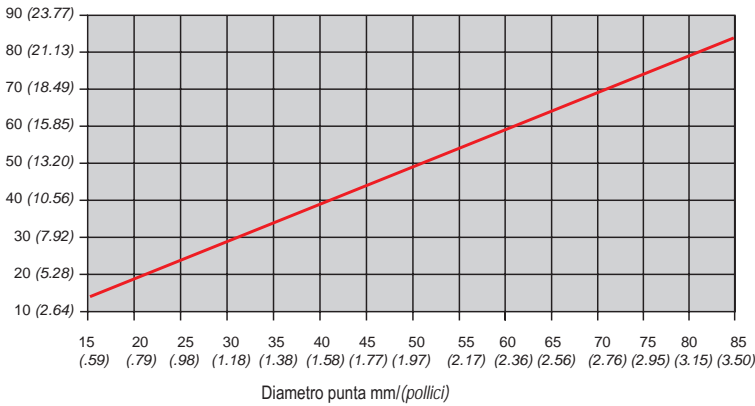

Pressione refrigerante necessaria

Pressione consigliata in bar (PSI)

Profondità di foratura	Diametro punta mm (pollici)		
	15-25 (0,591-0,984)	> 25-40 > 0,984-1,575	> 40 > 1,575
< 3 x D	6 (87)	4,5 (65)	3 (44)
≥ 3 x D	12 (174)	9 (130)	6 (87)

Forature a pacco

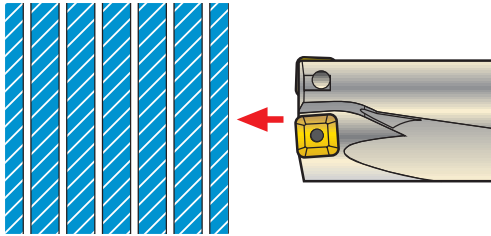

A condizione che il traferro (distanza fra le piastre) sia max 0,2 mm (0,008"), la foratura di piastre a pacco può essere effettuata con punte SD522 2 x D, SD523 3 x D e SD542 2,5 x D. I componenti devono essere fissati saldamente in modo da evitare flessioni durante l'attraversamento di ciascuna piastra.

Parametri di taglio ed inserti consigliati per la foratura di elementi a pacco

Geometria inserto:	Geometria inserto	Qualità di metallo duro
Inserto centrale	SPGX-C1	T400D
Inserto periferico	SCGX-P2	DP3000

Velocità di taglio: Vedere consigli per qualità DP3000 in metallo duro

Avanzamento/giro: Vedere consigli per geometria P2

Se insorgono problemi nel passaggio da una piastra all'altra, ridurre l'avanzamento/giro del 30-50%.

Attenzione!

Nei fori passanti viene generato un dischetto che, nelle applicazioni su tornio, può essere espulso ad alta velocità. È importante assicurarsi che la macchina abbia le dovute protezioni per salvaguardare la sicurezza dell'operatore.

Montaggio

Regolazioni del diametro del foro e consigli per l'applicazione

La punta può essere posizionata radialmente fuori centro in modo da ottenere un diametro maggiore o minore del nominale.

Il valore massimo del fuori centro è riportato nella colonna "Regolazione radiale" nella sezione relativa alle punte ad inserti.

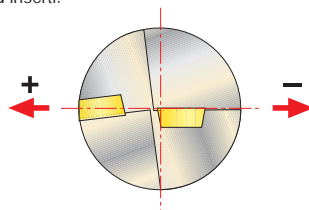

Utensili rotanti

I mandrini regolabili Seco sono consigliati per eseguire fori di precisione IT10 con punte SD522 e SD523, 3xD in applicazioni rotanti.

Utensili non rotanti

In fase di montaggio della punta, verificare che i taglienti siano paralleli alle slitte trasversali della macchina e che l'asse della punta e del pezzo siano allineati. Per ottenere fori maggiorati, posizionare la punta in modo che l'inserto periferico sia più distante dall'asse del pezzo.

Parametri di lavorazione SD602 – Grafici di potenza assorbita, portata refrigerante e forze applicate

I valori dei grafici variano, ad esempio, in funzione dei parametri di taglio e del materiale, con un'efficienza macchina dell'80%.

I grafici sono validi per i gruppi materiale Seco P5-P6 e per una velocità di taglio di 200 m/min (655 sf/min).

Forza di avanzamento

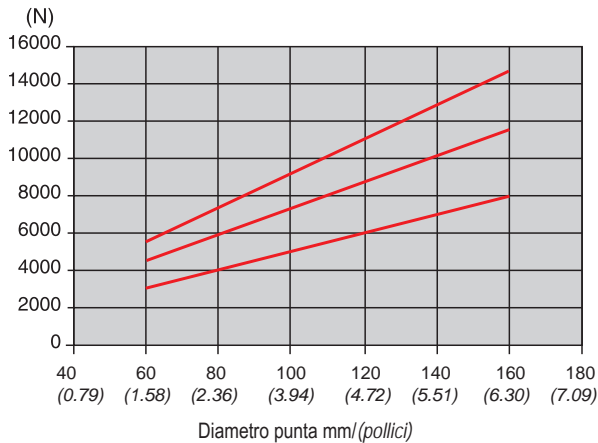

f = 0,18 mm/giro
(f = 0,007 pollici/giro)

f = 0,12 mm/giro
(f = 0,005 pollici/giro)

f = 0,08 mm/giro
(f = 0,003 pollici/giro)

Potenza assorbita

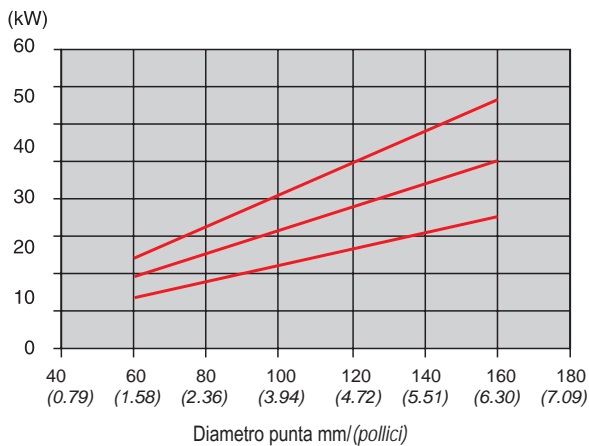

f = 0,18 mm/giro
(f = 0,007 pollici/giro)

f = 0,12 mm/giro
(f = 0,005 pollici/giro)

f = 0,08 mm/giro
(f = 0,003 pollici/giro)

Coppia applicata

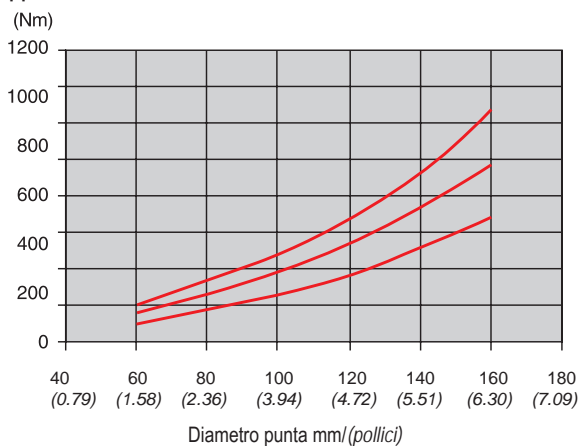

f = 0,18 mm/giro
(f = 0,007 pollici/giro)

f = 0,12 mm/giro
(f = 0,005 pollici/giro)

f = 0,08 mm/giro
(f = 0,003 pollici/giro)

Parametri di lavorazione SD602

Requisiti del volume di refrigerante

Litri/minuto (galloni/minuto)

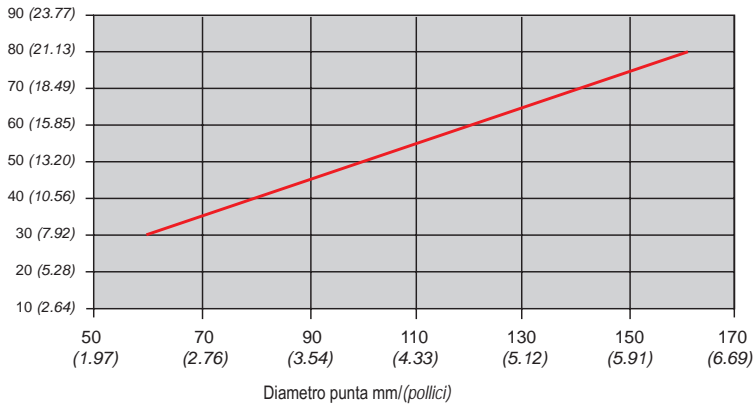

Metodi

Non consigliato	Soluzione
	<p>1. </p> <p>2. </p>
	<p>1. </p> <p>2. </p>
	<p>1. </p> <p>2. </p> <p>> 5xD</p>

Versatilità

Introduzione

Applicazioni

1. Foro con ingresso inclinato
2. Barenatura
3. Foratura attraverso un foro preesistente
4. Foratura e penetrazione assiale
5. Foratura e svasatura mediante interpolazione circolare
6. Penetrazione assiale

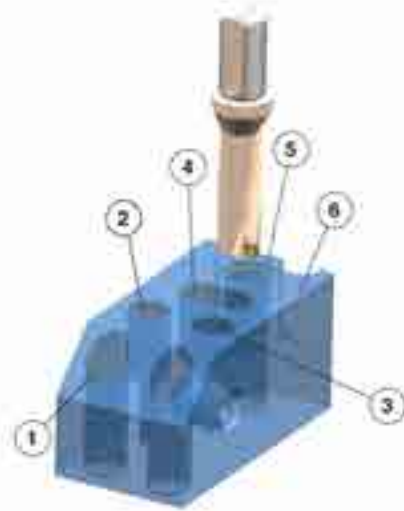

Foratura

Scelta multipla in operazioni non rotanti

1. Foratura
2. Barenatura / Foratura conica
3. Smusso

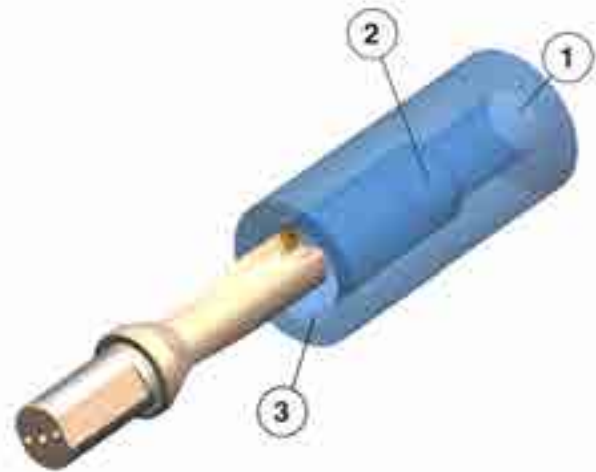

Alesatura

Raccomandazioni

- Punta 2 x D e 3 x D (SD522, SD523)
- Ridurre l'avanzamento di circa il 50% quando la punta non è completamente impegnata
- Usare la qualità DP3000
- Usare il formatruciolo -P2

Barenatura

Allegato

Risoluzione dei problemi

Vibrazioni

Applicazioni

- Controllare il montaggio della punta
- Controllare il montaggio del pezzo
- Aumentare l'avanzamento. Se si lavorano materiali teneri, ridurre l'avanzamento ed aumentare la velocità di taglio
- Ridurre la velocità di taglio

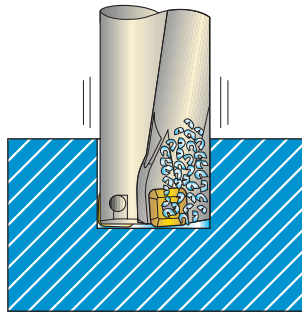

Coppia insufficiente

- Ridurre l'avanzamento
- Utilizzare una geometria per bassi avanzamenti con formatruciolo più robusto

Potenza insufficiente

- Ridurre la velocità di taglio
- Ridurre l'avanzamento
- Utilizzare una geometria per bassi avanzamenti con formatruciolo più robusto (SCGX-P1)

Problemi di truciolo lungo

Trucioli lunghi che causano problemi di evacuazione

- Incrementare l'avanzamento. Se si lavorano materiali teneri, ridurre l'avanzamento ed aumentare la velocità di taglio
- Utilizzare una geometria per bassi avanzamenti con formatruciolo più robusto (SCGX-P1)

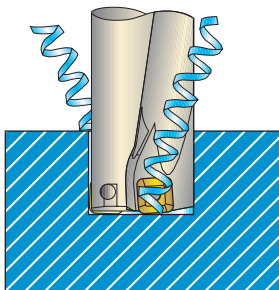

Intasamento vano scarico truciolo (truciolo corto)

- Aumentare pressione/volume del refrigerante
- Ridurre la velocità di taglio

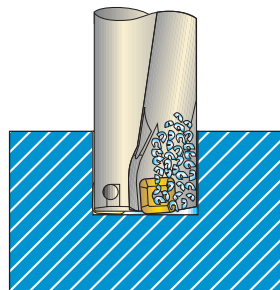

Rapida usura sul fianco sulla punta pilota

- Ridurre la velocità di taglio
- Aumentare la concentrazione del refrigerante

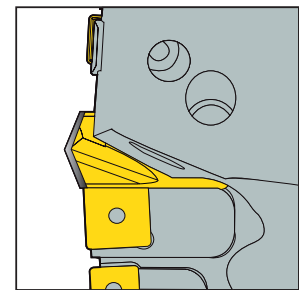

Problemi di durata

Scheggiatura dell'inserto periferico

- Ridurre l'avanzamento in entrata
- Scegliere una qualità più tenace
- Utilizzare una geometria per elevati avanzamenti (SCGX-P2)
- Ridurre l'avanzamento
- Ridurre la velocità di taglio



Scheggiatura dell'inserto centrale

- Controllare il montaggio della punta
- Controllare il montaggio del pezzo
- Ridurre l'avanzamento in entrata
- Aumentare l'avanzamento
- Ridurre la velocità di taglio



Rapida usura sul fianco sull'inserto periferico

- Ridurre la velocità di taglio
- Aumentare pressione/volume del refrigerante
- Scegliere una qualità più resistente all'usura



Adattatori regolabili per punte

Introduzione

Foratura

Alesatura

Barenatura

Allegato

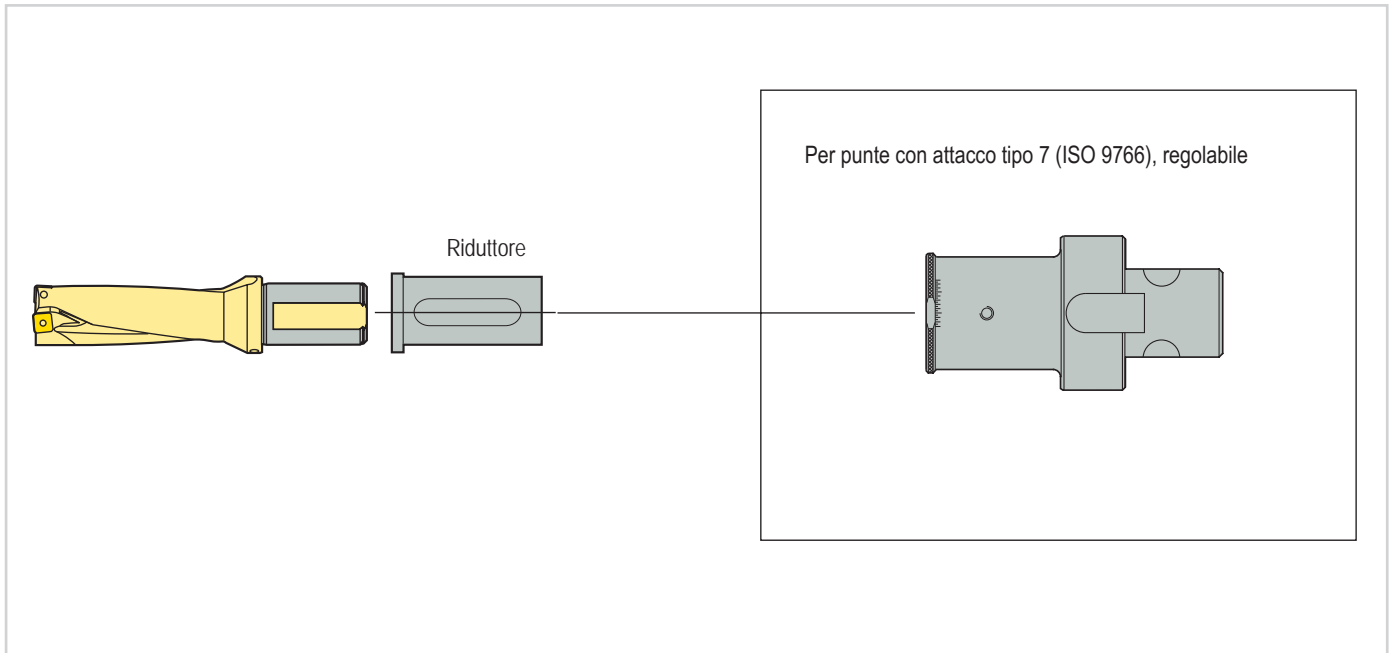

ADH 6101– Attacchi per punte regolabili, per punte con codoli tipo 7

Graflex®

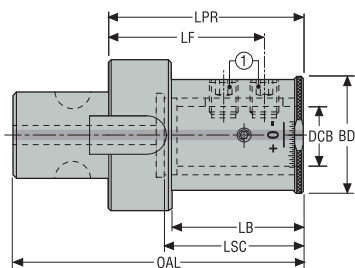

1. Vite di bloccaggio



- Per punte PerfoMAX®
- Regolabile da -0,3 mm a +0,8 mm

Codice di ordinazione	Codice prodotto	Lato macchina Dimensione attacco Graflex	Lato utensile		OAL	LPR	BD	LF	LB	LSC	Peso	Equilibratura
			Per corpo punta	DCB								
					mm Inch	mm Inch	mm Inch	mm Inch	mm Inch	mm Inch	kg lb	
BM061610025	02422113	G6	R7	25,0 0.984	110,0 4.331	70,0 2.756	49,0 1.929	55,0 2.165	54,0 2.126	54,0 2.126	1,12 2.470	PB
BM061610032	02422114	G6	R7	32,0 1.260	125,0 4.921	85,0 3.346	71,0 2.795	70,0 2.756	66,0 2.598	60,5 2.382	2,1 4.630	PB
BM061610040	02422115	G6	R7	40,0 1.575	125,0 4.921	85,0 3.346	81,0 3.189	70,0 2.756	66,0 2.598	60,5 2.382	2,4 5.290	PB
BM061610125	02422116	G6	R7	25,4 1.000	110,0 4.331	70,0 2.756	49,0 1.929	55,0 2.165	54,0 2.126	54,5 2.146	1,11 2.450	PB
BM061610138	02422118	G6	R7	38,1 1.500	125,0 4.921	85,0 3.346	81,0 3.189	70,0 2.756	66,0 2.598	60,5 2.382	2,45 5.400	PB

Parti di ricambio, comprese nella fornitura

Per DCB	Vite di bloccaggio	Tenone
25/0.984	950AF1210014	90M61
32/1.260	-	90M61
40/1.575	-	90M61
25,4/1.000	950AF1210014	90M61
38,1/1.500	-	90M61

Accessori

Per DCB	Chiave (impugnatura a T)	Chiave
25/0.984	DOUBLE-T	H6B-H6.0L
32/1.260	DOUBLE-T	H6B-H6.0L
40/1.575	DOUBLE-T	H6B-H6.0L
25,4/1.000	DOUBLE-T	H6B-H6.0L
38,1/1.500	-	-

PB=Pre-equilibratura (per ulteriori dettagli, vedere la pagina relativa alla guida all'equilibratura nel catalogo Tooling Systems (Sistemi di utensili))

Integrale o ad inserto – Scegliere la soluzione migliore

Qualità, prestazioni e basso costo dell'utensile sono gli obiettivi da raggiungere. La scelta di un utensile per alesatura dipende dalla tolleranza richiesta, dal numero di pezzi da produrre e dal tempo di lavorazione. I sistemi Seco per la lavorazione fori soddisfano queste richieste.

Gli alesatori Precimaster, Bifix, Xfix e Nanofix di Seco possono risolvere tutti i problemi riguardanti l'alesatura.

Lo schema sotto riportato guida alla scelta dell'utensile ideale per l'alesatura

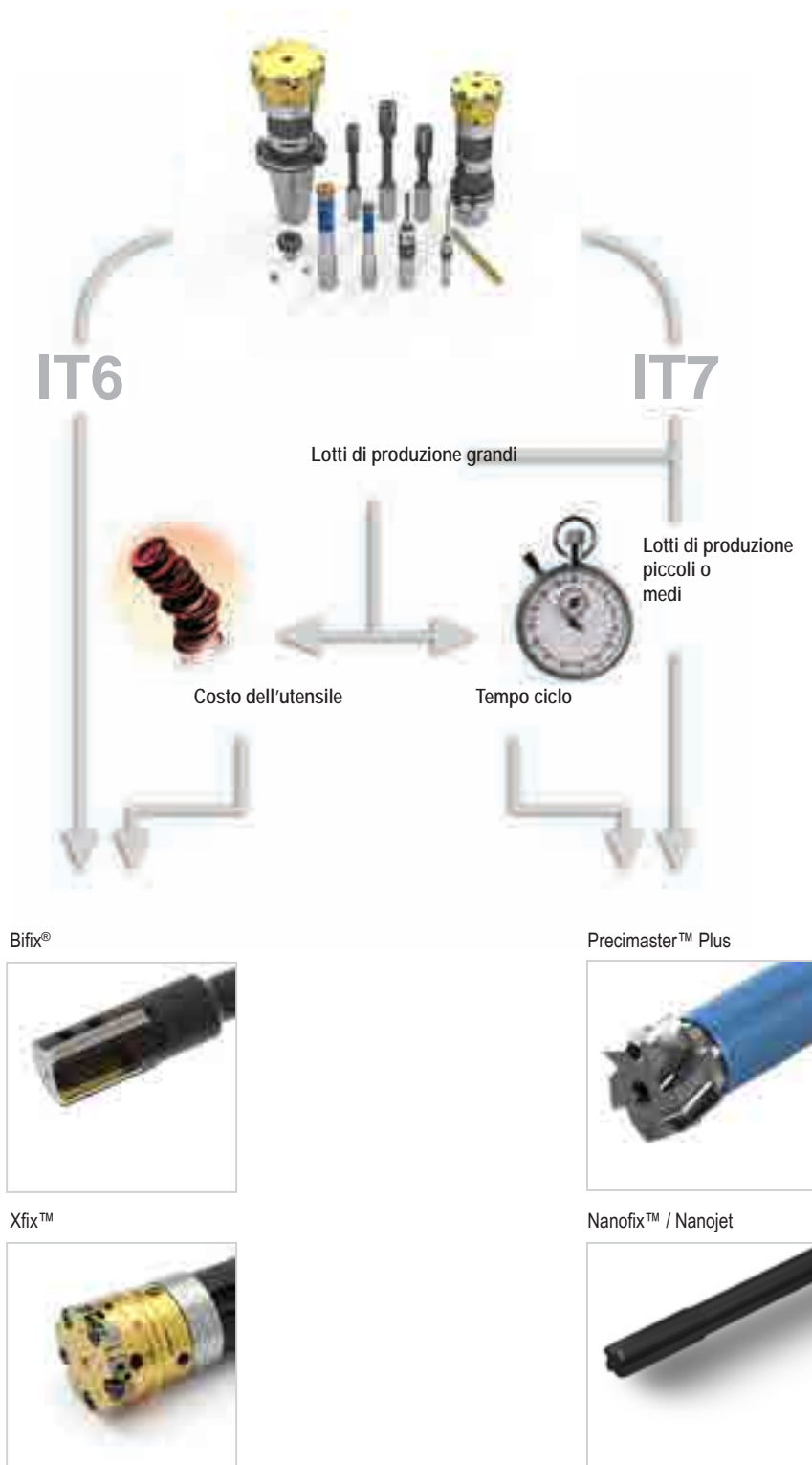

Introduzione

Foratura

Alesatura

Barenatura

Allegato

Panoramica della gamma

	Gamma ∅	Profondità di alesatura	Tolleranza ∅ foro	Diametro intermedio	Finitura superficiale
Precimaster™ Plus  Pagine 328-367	7,75-60,500 mm (0.3051-2.3818")	~ 2-10 x D	IT 6-7-8	Disponibile tramite My Design	R _a 0,2-1,2 μm (R _a 7.87-47.2 μin)
Nanofix™  Pagine 368-401	2,970-12,050 mm (0.1169-0.4744")	~ 5-12 x D	IT 7	Disponibile tramite My Design	R _a 0,2-1,2 μm (R _a 7.87-47.2 μin)
Nanojet  Pagine 402-422	1,461-9,960 mm (0.057-0.392")	~ 4-7 x D	IT 7	Disponibile tramite My Design	R _a 0,2-1,2 μm (R _a 7.87-47.2 μin)
Bifix®  Pagine 423-449	5,900-60,500 mm (0.2323-2.3819")	~ 2-7 x D	IT 6-7	Disponibile tramite My Design	R _a 0,2-0,8 μm (R _a 7.87-31.5 μin)
Xfix™  Pagine 450-490	39,500-154,500 mm (1.5551-6.0827")	~ 2,5-6,5 x D	IT 6	Disponibile tramite My Design	R _a 0,8-1,6 μm (R _a 31-63 μin)



Precimaster™ Plus

Precimaster™ Plus è un sistema di alesatura modulare che privilegia la velocità, la stabilità e la versatilità dell'alesatura, per una realizzazione di fori economicamente vantaggiosa e di elevata precisione.

- Il sistema è caratterizzato da una connessione innovativa e molto precisa, testine in metallo duro integrale e steli standard per la realizzazione di fori ciechi e passanti
- Consente di realizzare fori con campi di tolleranza da 15 a 25 micron e finiture superficiali da R_a 0,4 a R_a 0,8 μm (RMS da 15 a 35 micro/pollici)

Precimaster™ Plus – Panoramica della gamma

	Gamma ∅	Profondità di alesatura	Tolleranza ∅ foro	Diametro intermedio	Finitura superficiale
PMX5 / PMX6 / PMX8 	7,75-60 mm (0.3051-2.3622")	~ 2-3 x D	IT 6-7-8	Disponibile tramite My Design	R _a 0,2-1,2 μm (R _a 7.87-47.2 μin)
PMX5 / PMX6 / PMX8 	7,75-60 mm (0.3051-2.3622")	~ 4-5 x D	IT 6-7-8	Disponibile tramite My Design	R _a 0,2-1,2 μm (R _a 7.87-47.2 μin)
PMX5 / PMX6 / PMX8 	7,75-60 mm (0.3051-2.3622")	~ 8-10 x D	IT 6-7-8	Disponibile tramite My Design	R _a 0,2-1,2 μm (R _a 7.87-47.2 μin)

Introduzione

Foratura

Alesatura

Barenatura

Allegato

Chiavi di codifica

Gli steli Precimaster Plus sono adatti sia per fori ciechi sia per fori passanti.

Stelo

Introduzione

Foratura

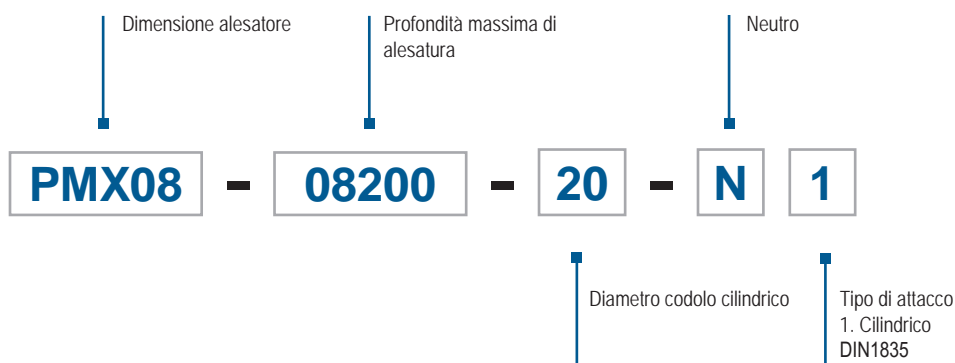

Testina

Alesatura

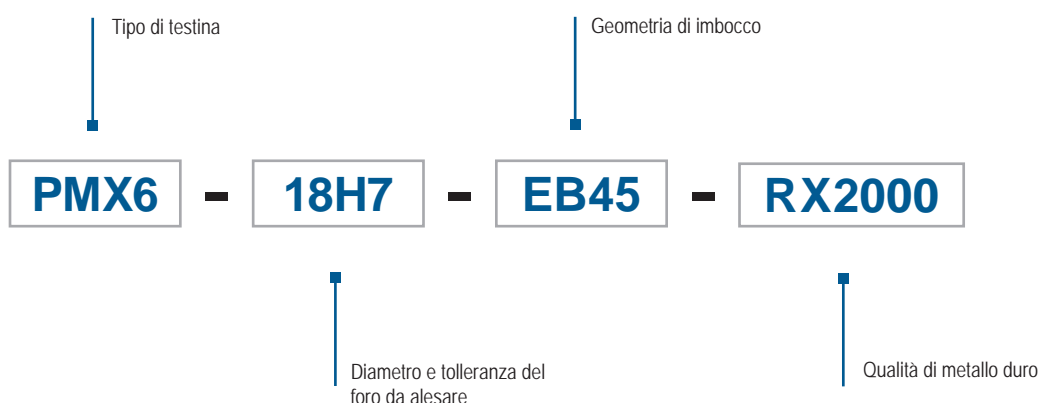

PMX6

Diametro intermedio testina

Barenatura

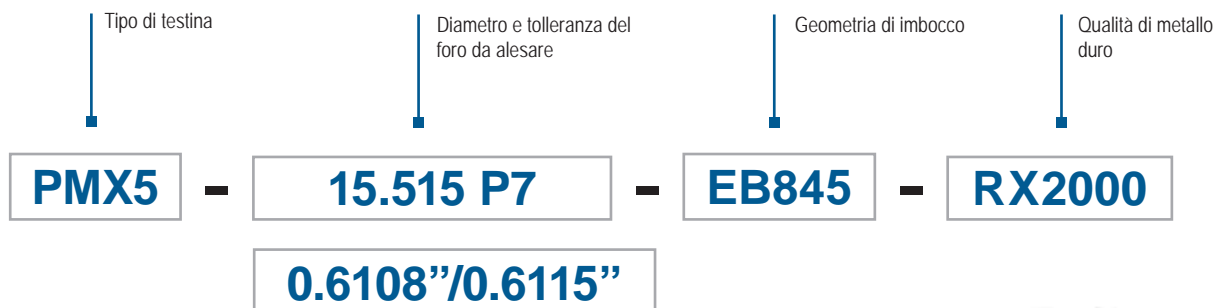

PMX4: Versione elicoidale DX, adatta solo a fori ciechi.
 PMX5: Versione con elica diritta, adatta a fori ciechi e fori passanti.
 PMX6: Versione elicoidale SX, adatta solo a fori passanti.
 PMX8: Versione espandibile, con elica diritta, adatta a fori ciechi e fori passanti.
 L'elica sinistra facilita l'evacuazione del truciolo in avanti.
 L'elica destra facilita l'evacuazione del truciolo in avanti.
 Vedere la pagina 337 per la scelta della testina Precimaster Plus



PMX4



PMX5



PMX8

Allegato

Chiavi di codifica

Gli steli Precimaster Plus sono adatti sia per fori ciechi che per fori passanti.

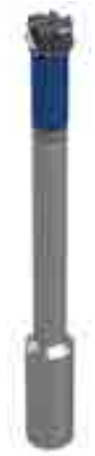
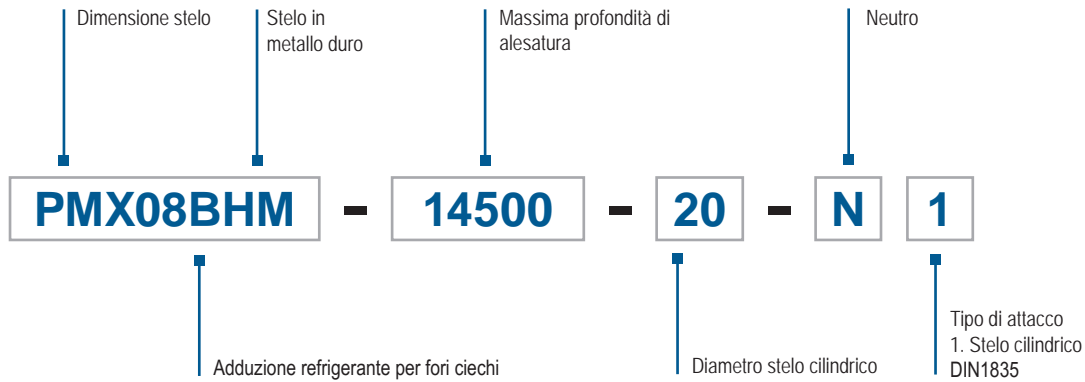

Introduzione

Foratura

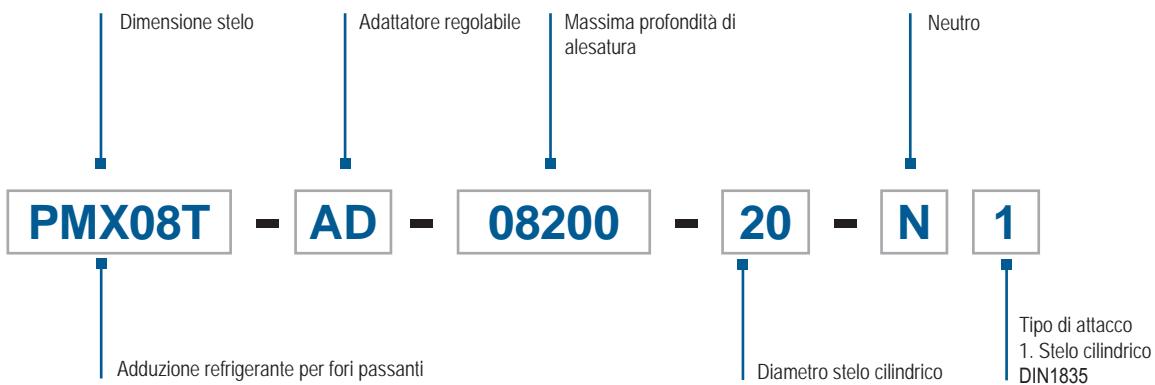

Alesatura

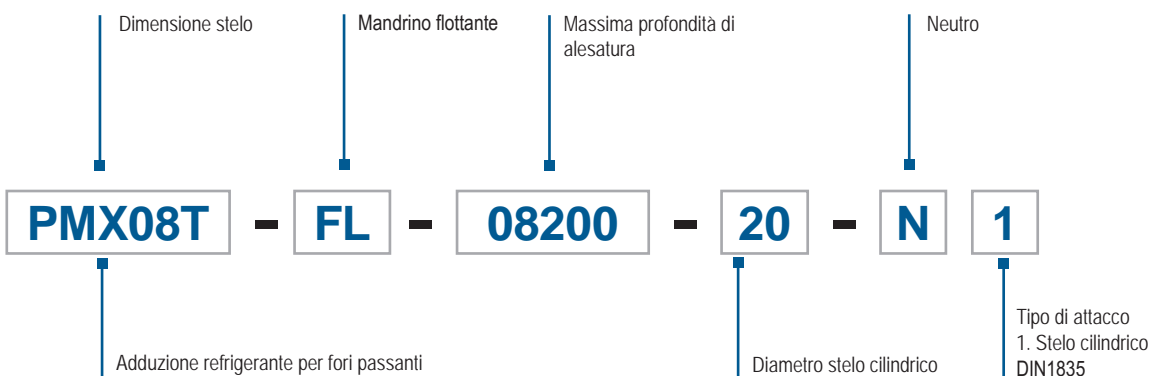

Barenatura

Allegato

Impostazione del refrigerante

Procedura per l'impostazione dell'uscita refrigerante: descrizione parti di ricambio

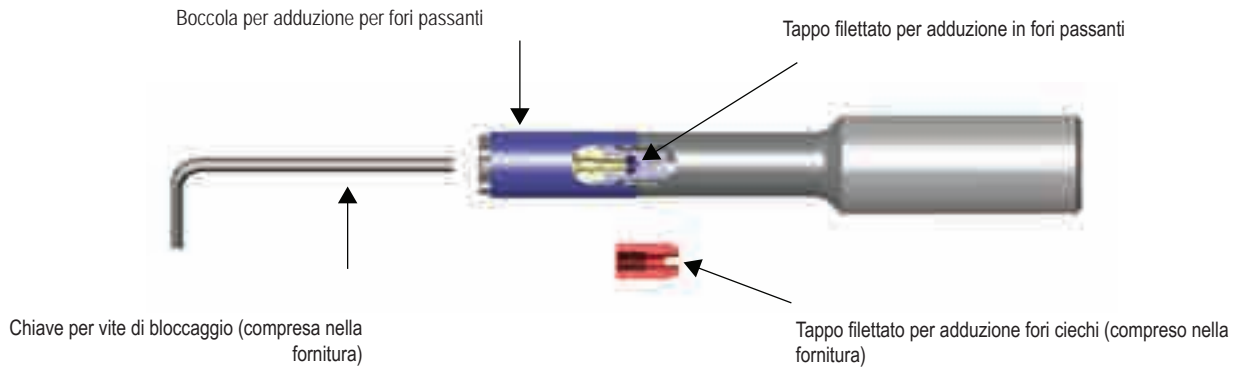

Procedura per l'impostazione dell'uscita refrigerante: Impostazione dell'utensile per adduzione fori ciechi

1.

Rimuovere il tappo filettato per fori passanti (blu)
Nota: i tappi filettati hanno filettatura sinistra



Dimensione stelo	Dimensione cacciavite a taglio in mm	Dimensione cacciavite a taglio in pollici	Dimensione chiave esagonale in mm	Dimensione chiave esagonale in pollici
PMX05	1,2 x 4 x 120	0,05 x 0,16 x 4,72	2 x 120	0,08 x 4,72
PMX06	1,0 x 5,5 x 150	0,04 x 0,22 x 5,9	2,5 x 150	0,10 x 5,9
PMX08	1,2 x 6,5 x 200	0,05 x 0,26 x 7,87	3 x 200	0,12 x 7,87
PMX12	1,2 x 8 x 200	0,05 x 0,31 x 6,89	5 x 200	0,2 x 6,89

Usare un cacciavite a taglio OPPURE una chiave esagonale, delle dimensioni indicate nella tabella

2.

Rimuovere la boccola per adduzione



3.

Montare il tappo filettato per adduzione fori ciechi
Nota: i tappi filettati hanno filettatura sinistra



Montaggio della testina

<p>1. Verificare che la geometria della testina sia adatta alla tipologia di refrigerante</p>	<p>PMX5/PMX8 PMX6</p> <p>PMX5/PMX8</p> <p>Fori passanti</p> <p>Fori ciechi</p>	Introduzione												
<p>2. Posizionare il sistema di bloccaggio prima di montare la testina</p>		Foratura												
<p>3. Allineare la scanalatura in corrispondenza del punto rosso sul corpo</p>	<p>Scanalature piccole</p> <p>Scanalature grandi</p>	Alesatura												
<p>4. Posizionare la testina sul corpo</p>		Barenatura												
<p>5. Spingere la testina nel corpo fino a quando si sente "clic"</p>	<p>Click</p>	Allegato												
<p>6. Bloccare la testina con la chiave esagonale</p>	<table border="1" data-bbox="1054 1787 1437 1957"> <thead> <tr> <th>PMX Dimensione codolo</th> <th>Coppia di serraggio consigliata</th> </tr> </thead> <tbody> <tr> <td>PMX05</td> <td>0,5 Nm</td> </tr> <tr> <td>PMX06</td> <td>0,9 Nm</td> </tr> <tr> <td>PMX08</td> <td>1,2 Nm</td> </tr> <tr> <td>PMX12</td> <td>2,0 Nm</td> </tr> <tr> <td>PMX16</td> <td>5,0 Nm</td> </tr> </tbody> </table>	PMX Dimensione codolo	Coppia di serraggio consigliata	PMX05	0,5 Nm	PMX06	0,9 Nm	PMX08	1,2 Nm	PMX12	2,0 Nm	PMX16	5,0 Nm	Allegato
PMX Dimensione codolo	Coppia di serraggio consigliata													
PMX05	0,5 Nm													
PMX06	0,9 Nm													
PMX08	1,2 Nm													
PMX12	2,0 Nm													
PMX16	5,0 Nm													

Montaggio – Errore di concentricità

Utensile rotante

Massima eccentricità raccomandata: 10-15 μm (393,7008-590,5512 μin).
Si consigliano mandrini idraulici o a calettamento termico o un porta pinze di precisione.
Per il miglior controllo dell'eccentricità, consigliamo l'uso degli adattatori regolabili Precimaster Plus PMX-AD, vedere le pagine 350-351.



Utensile fermo

Usare steli flottanti Precimaster Plus PMX - FL, vedere le pagine 352-353.

I mandrini flottanti consentono all'alesatore di auto-centrarsi nel preforo.



Requisiti del refrigerante

Per la massima durata utensile ed una buona qualità del foro, si devono soddisfare i seguenti requisiti relativi al refrigerante.
Si raccomanda l'adduzione del refrigerante attraverso l'utensile. L'adduzione esterna è possibile se la profondità di alesatura è $< 2 \times D$.
Olio solubile di qualità con almeno il 40% di olio minerale.
Per l'acciaio inossidabile si consiglia olio puro.
Concentrazione minima 6-8%.
Filtrazione 30-50 μm (1200-2000 μin).
Volume minimo 0,5 l/min/mm (3,35 gal/min/pollici) nel diametro utensile.
(Esempio: alesatore $\varnothing 10$, il volume minimo è 5 l/min (1,3 gal/min).



Misura diametro



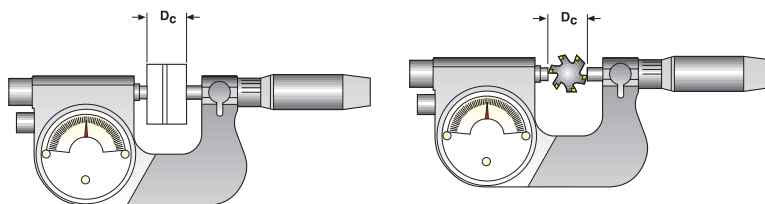

Calibrare il micrometro a quadrante prima della misura del \varnothing .

Importante
Gli alesatori Precimaster hanno passo differenziato. Durante la misura del diametro, è necessario assicurarsi di misurare due lame opposte a 180°.

Per le rilevazioni, utilizzare un micrometro a quadrante e dei tastatori comparatori.



Regolazione della configurazione degli attacchi:

<p>1. Montare il master per controllo errore (fornito con attacco regolabile).</p> <p>Montare l'utensile sul mandrino.</p> <p>2. Impostare l'orologio come mostrato.</p>		<p>Introduzione</p>
<p>3. Ruotare l'utensile a mano fino a trovare il valore più basso indicato.</p>		
<p>4. Procedere alla compensazione dell'eccentricità mediante le viti di regolazione. Direzione indicata dalle frecce.</p> <p>5. Controllare l'eccentricità e ripetere la compensazione se necessario.</p>		<p>Alesatura</p>
<p>6. Quando l'eccentricità (run-out) massima è inferiore a 5 mm (197 μin), serrare le viti per bloccare la regolazione</p>		<p>Barenatura</p>
<p>Allegato</p>	<p>Allegato</p>	<p>Allegato</p>









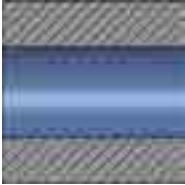

Configurazione attacchi flottanti:

Introduzione	<p>1. Bloccare completamente lo stelo flottante ruotando l'anello di regolazione in senso orario.</p>	
Foratura	<p>2. Aprire lo stelo flottante di 2 o 3 scatti, ruotando l'anello di regolazione in senso antiorario</p>	
Alesatura	<p>3. Se necessario, procedere a un'ulteriore regolazione dell'anello flottante. Un valore troppo variabile può creare condizioni instabili all'ingresso del foro. Un gioco del flottante troppo piccolo può creare vibrazioni ed un foro conico.</p>	

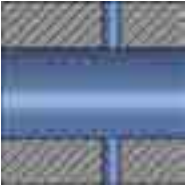
Compensazione usura dell'alesatore espandibile

Barenatura	<p>1. Usare la chiave esagonale per compensare l'usura dell'utensile sul \emptyset (incrementi di $60^\circ =$ circa $0,005 \mu\text{m}$ ($0,197 \mu\text{in}$) di compensazione sul \emptyset)</p>	
Allegato	<p>2. Dopo l'espansione, controllare il \emptyset usando un micrometro a quadrante</p>	

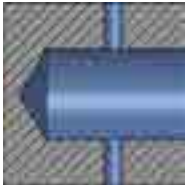
Scelta della testa

Pezzo in lavorazione		Diametro da alesare \varnothing 8-60 mm (0,3150-2,3622")		
<p>Foro passante corto < 3 x D</p> 	<p>PMX5 / PMX8</p> 		Introduzione	
<p>Foro passante lungo > 3 x D</p> 	<p>PMX6</p> <p>Per fori passanti, l'uscita di refrigerante del portautensile deve essere impostata per fori passanti: vedere le pagine relative all'impostazione del refrigerante</p> 			Foratura
<p>Foro passante attraverso un foro preesistente</p> 				
<p>Foro cieco</p> 	<p>PMX5 / PMX8</p> <p>Per fori ciechi, l'uscita di refrigerante del portautensile deve essere impostata per fori ciechi: vedere le pagine relative all'impostazione del refrigerante</p> 		Barenatura	
<p>Foro cieco attraverso un foro preesistente</p> 				Allegato
<p>Foro cieco > 3x D</p> 	<p>PMX4</p> <p>Per fori ciechi, l'uscita di refrigerante del portautensile deve essere impostata per fori ciechi: vedere le pagine relative all'impostazione del refrigerante</p> 			

Scelta della geometria – Applicazioni

Introduzione	<h3>Geometria di imbocco - EB45</h3>	
Foratura	<h3>Geometria di imbocco - EBS45</h3>	
Alesatura	<h3>Geometria di imbocco - EB845</h3>	

Controllo truciolo ++
Finitura superficiale+++ R_a 0,8-1,2 μm
(Finitura superficiale+++ R_a 31-47 μin)
Versatile

Controllo truciolo +++
Finitura superficiale + R_a 0,8-1,2
(Finitura superficiale + R_a 31-47 μin)
EB45 corto

Controllo truciolo ++
Finitura superficiale+++ R_a 0,2-0,8 μm
(Finitura superficiale+++ R_a 8-31 μin)

Scelta della geometria – Applicazioni

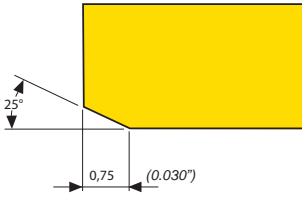
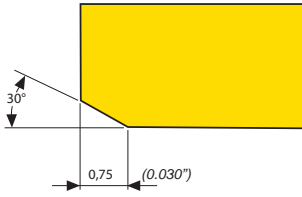
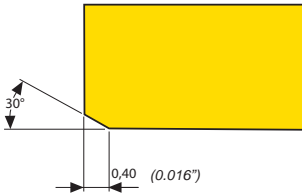



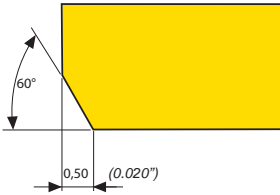
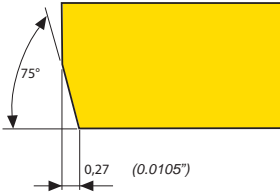



Geometria di imbocco - EB25	
<p>Possibilità di avanzamenti elevati +++ Finitura superficiale ++ R_a 0,4-0,8 μm (Finitura superficiale ++ R_a 16-31 μin) Controllo truciolo +</p>	
Geometria di imbocco - EB30	
<p>Possibilità di avanzamenti elevati +++ Finitura superficiale ++ (R_a 0,4-0,8 μm) (Finitura superficiale ++ R_a 16-31 μin) Controllo truciolo +</p>	
Geometria di imbocco - EBS30	
<p>Possibilità di avanzamenti elevati +++ Finitura superficiale ++ R_a 0,4-0,8 μm (Finitura superficiale ++ R_a 16-31 μin) Controllo truciolo + EB30 corto</p>	

Scelta della geometria – Applicazioni

Introduzione	<h3>Geometria di imbocco - EB60</h3>	
Foratura	<p>Possibilità di avanzamenti elevati + Finitura superficiale ++ R_a 0,8-1,2 μm (Finitura superficiale ++ R_a 31-47 μin) Controllo truciolo ++</p>	
Alesatura	<h3>Geometria di imbocco - EB75</h3>	
Barenatura	<p>Possibilità di avanzamenti elevati + Finitura superficiale ++ R_a 0,8-1,2 μm (Finitura superficiale ++ R_a 31-47 μin) Controllo truciolo ++</p>	
Allegato		

Scelta della geometria – Applicazioni

Geometria di imbocco - RE040	
<p>Possibilità di avanzamenti elevati ++ Finitura superficiale ++ R_a 0,4-0,8 μm (Finitura superficiale ++ R_a 16-31 μin) Controllo truciolo +</p>	 <p>Non per spallamenti</p> <p>R0,40 (R.016")</p>
Geometria di imbocco - RE080	
<p>Possibilità di avanzamenti elevati ++ Finitura superficiale ++ R_a 0,4-0,8 μm (Finitura superficiale ++ R_a 16-31 μin) Controllo truciolo +</p>	 <p>Non per spallamenti</p> <p>R0,80 (R.031")</p>
Geometria di imbocco - RE120	
<p>Possibilità di avanzamenti elevati ++ Finitura superficiale ++ R_a 0,4-0,8 μm (Finitura superficiale ++ R_a 16-31 μin) Controllo truciolo + Disponibile da \varnothing 14 mm (0,551")</p>	 <p>Non per spallamenti</p> <p>R1,20 (R.047")</p>

Qualità		
Introduzione		RX2000 Rivestita Qualità rivestita ad alte prestazioni per tutti i materiali da lavorare.
		CP20 Rivestita Qualità rivestita versatile adatta per la maggior parte dei materiali da lavorare, tranne l'alluminio. TiN
Foratura		H15 Non rivestita Qualità micrograna tenace per tutti i materiali da lavorare. Adatta per operazioni di finitura, grazie all'affilatura del tagliente.
		CF Cermet Qualità resistente all'usura per l'ottimizzazione delle prestazioni su acciaio.
		RX1500 Cermet rivestito Qualità rivestita resistente per l'ottimizzazione delle prestazioni su acciaio e ghisa.
Alesatura		RN2010 Non rivestita Qualità sub-micrograna non rivestita con geometrie ottimizzate per materiali N (non ferrosi).
		RM2020 Rivestita Qualità rivestita tenace per operazioni di finitura con geometrie ottimizzate per materiali M.
		RM2090 Rivestita Qualità rivestita resistente all'usura con geometrie specifiche per materiali M. Ottimizzazione su materiali M.
Barenatura		RK2050 Rivestita Qualità rivestita tenace per operazioni di finitura con geometrie ottimizzate per materiali K.
		RK1550 Cermet rivestito Qualità rivestita resistente all'usura con geometrie specifiche per materiali K. Ottimizzazione per materiali K.
Allegato		RS2090 Rivestita Qualità rivestita resistente all'usura con geometrie specifiche per materiali S. Ottimizzazione su materiali S.

Teste per fori passanti e ciechi

Ø 8-32 mm / 0.315-1.260"

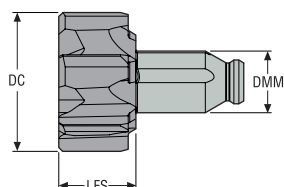

- Per la scelta della geometria, vedere le pagine 338-341
- Per i parametri di taglio raccomandati, vedere pagina(e) 360-367

Codice di ordinazione	Codice prodotto	DC	Dimensione della punta*			LFS	DMM	Dimensione stelo	Geometrie			Qualità				
			mm	mm					mm	mm	EB45	EB45	EB30	H15	CP20	RX2000
PMX5-8H7-EB45	03123158	8,0	7,8/7,9	6	6,0	4,5	PMX05-xx	■	□	□	□	□	■	-	-	
PMX5-9H7-EB45	03123159	9,0	8,8/8,9	6	6,0	4,5	PMX05-xx	■	□	□	□	□	■	-	-	
PMX5-10H7-EB30	10020602	10,0	9,8/9,9	6	7,0	6,0	PMX06-xx	□	□	■	□	□	■	□	□	
PMX6-10H7-EB45	02965863	10,0	9,8/9,9	6	7,0	6,0	PMX06-xx	■	□	□	□	□	■	□	□	
PMX5-11H7-EB45	02925754	11,0	10,8/10,9	6	7,0	6,0	PMX06-xx	■	□	□	□	□	■	□	□	
PMX5-12H7-EB30	10019482	12,0	11,8/11,908	6	7,0	6,0	PMX06-xx	□	□	■	□	□	■	□	□	
PMX5-12H7-EB45	02925755	12,0	11,8/11,908	6	7,0	6,0	PMX06-xx	■	□	□	□	□	■	□	□	
PMX5-13H7-EB30	10019483	13,0	12,8/12,9	6	7,0	6,0	PMX06-xx	□	□	■	□	□	■	□	□	
PMX5-13H7-EB45	02925756	13,0	12,8/12,9	6	7,0	6,0	PMX06-xx	■	□	□	□	□	■	□	□	
PMX5-14H7-EB30	10019484	14,0	13,8/13,891	6	7,0	6,0	PMX06-xx	□	□	■	□	□	■	□	□	
PMX5-14H7-EB45	02925757	14,0	13,8/13,891	6	7,0	6,0	PMX06-xx	■	□	□	□	□	■	□	□	
PMX5-15H7-EB30	10019485	15,0	14,8/14,9	6	10,0	8,0	PMX08-xx	□	□	■	□	□	■	□	□	
PMX5-15H7-EB45	02925758	15,0	14,8/14,9	6	10,0	8,0	PMX08-xx	■	□	□	□	□	■	□	□	
PMX5-16H7-EB30	10019486	16,0	15,8/15,9	6	10,0	8,0	PMX08-xx	□	□	■	□	□	■	□	□	
PMX5-16H7-EB45	02925759	16,0	15,8/15,9	6	10,0	8,0	PMX08-xx	■	□	□	□	□	■	□	□	
PMX5-17H7-EB30	10019487	17,0	16,8/16,9	6	10,0	8,0	PMX08-xx	□	□	■	□	□	■	□	□	
PMX5-17H7-EB45	02925760	17,0	16,8/16,9	6	10,0	8,0	PMX08-xx	■	□	□	□	□	■	□	□	
PMX5-18H7-EB30	10019488	18,0	17,8/17,9	6	10,0	8,0	PMX08-xx	□	□	■	□	□	■	□	□	
PMX5-18H7-EB45	02925761	18,0	17,8/17,9	6	10,0	8,0	PMX08-xx	■	□	□	□	□	■	□	□	
PMX5-19H7-EB30	10019489	19,0	18,8/18,9	6	10,0	8,0	PMX08-xx	□	□	■	□	□	■	□	□	
PMX5-19H7-EB45	02925762	19,0	18,8/18,9	6	10,0	8,0	PMX08-xx	■	□	□	□	□	■	□	□	
PMX5-20H7-EB30	10020603	20,0	19,8/19,9	6	10,0	8,0	PMX08-xx	□	□	■	□	□	■	□	□	
PMX5-20H7-EB45	02925763	20,0	19,8/19,9	6	10,0	8,0	PMX08-xx	■	□	□	□	□	■	□	□	
PMX5-21H7-EB45	02925764	21,0	20,8/20,9	6	10,0	8,0	PMX08-xx	■	□	□	□	□	■	□	□	
PMX5-22H7-EB30	10020604	22,0	21,8/21,9	8	12,0	12,0	PMX12-xx	□	□	■	□	□	■	□	□	
PMX5-22H7-EB45	02925765	22,0	21,8/21,9	8	12,0	12,0	PMX12-xx	■	□	□	□	□	■	□	□	
PMX5-23H7-EB30	10019490	23,0	22,8/22,9	8	12,0	12,0	PMX12-xx	□	□	■	□	□	■	□	□	
PMX5-23H7-EB45	02925766	23,0	22,8/22,9	8	12,0	12,0	PMX12-xx	■	□	□	□	□	■	□	□	
PMX5-24H7-EB30	10019491	24,0	23,813/23,9	8	12,0	12,0	PMX12-xx	□	□	■	□	□	■	□	□	
PMX5-24H7-EB45	02925767	24,0	23,813/23,9	8	12,0	12,0	PMX12-xx	■	□	□	□	□	■	□	□	
PMX5-25H7-EB30	10019492	25,0	24,8/24,9	8	12,0	12,0	PMX12-xx	□	□	■	□	□	■	□	□	
PMX5-25H7-EB45	02925768	25,0	24,8/24,9	8	12,0	12,0	PMX12-xx	■	□	□	□	□	■	□	□	
PMX5-26H7-EB30	10019493	26,0	25,8/25,9	8	12,0	12,0	PMX12-xx	□	□	■	□	□	■	□	□	
PMX5-26H7-EB45	02925769	26,0	25,8/25,9	8	12,0	12,0	PMX12-xx	■	□	□	□	□	■	□	□	
PMX5-27H7-EB45	02925770	27,0	26,8/26,9	8	12,0	12,0	PMX12-xx	■	□	□	□	□	■	□	□	
PMX5-28H7-EB30	10019494	28,0	26,8/26,9	8	12,0	12,0	PMX12-xx	□	□	■	□	□	■	□	□	

Introduzione

Foratura

Alesatura

Barenatura

Allegato

Codice di ordinazione	Codice prodotto	DC	Dimensione della punta*		LFS	DMM	Dimensione stelo	Geometrie			Qualità				
			mm	mm					mm	mm	EB45	EB845	EB30	H15	CP20
PMX5-28H7-EB45	02925771	28,0	27,8/27,9	8	12,0	12,0	PMX12-xx	<input checked="" type="checkbox"/>	<input type="checkbox"/>	<input type="checkbox"/>	<input type="checkbox"/>	<input type="checkbox"/>	<input checked="" type="checkbox"/>	<input type="checkbox"/>	<input type="checkbox"/>
PMX5-29H7-EB45	02925772	29,0	28,8/28,9	8	12,0	12,0	PMX12-xx	<input checked="" type="checkbox"/>	<input type="checkbox"/>	<input type="checkbox"/>	<input type="checkbox"/>	<input type="checkbox"/>	<input checked="" type="checkbox"/>	<input type="checkbox"/>	<input type="checkbox"/>
PMX5-30H7-EB30	10019495	30,0	29,8/29,9	8	12,0	12,0	PMX12-xx	<input type="checkbox"/>	<input type="checkbox"/>	<input checked="" type="checkbox"/>	<input type="checkbox"/>	<input type="checkbox"/>	<input checked="" type="checkbox"/>	<input type="checkbox"/>	<input type="checkbox"/>
PMX5-30H7-EB45	02925773	30,0	29,8/29,9	8	12,0	12,0	PMX12-xx	<input checked="" type="checkbox"/>	<input type="checkbox"/>	<input type="checkbox"/>	<input type="checkbox"/>	<input type="checkbox"/>	<input checked="" type="checkbox"/>	<input type="checkbox"/>	<input type="checkbox"/>
PMX5-32H7-EB30	10019496	32,0	31,8/31,9	8	12,0	12,0	PMX12-xx	<input type="checkbox"/>	<input type="checkbox"/>	<input checked="" type="checkbox"/>	<input type="checkbox"/>	<input type="checkbox"/>	<input checked="" type="checkbox"/>	<input type="checkbox"/>	<input type="checkbox"/>
PMX5-32H7-EB45	02925775	32,0	31,8/31,9	8	12,0	12,0	PMX12-xx	<input checked="" type="checkbox"/>	<input type="checkbox"/>	<input type="checkbox"/>	<input type="checkbox"/>	<input type="checkbox"/>	<input checked="" type="checkbox"/>	<input type="checkbox"/>	<input type="checkbox"/>

*Per ulteriori informazioni su quale punta scegliere e su come utilizzarla, vedere le pagine 8
 Prodotto standard a stock Prodotto standard non a stock.

Introduzione

Foratura

Alesatura

Barenatura

Allegato

Teste per fori passanti

Ø 8-32 mm / 0.315-1.260"

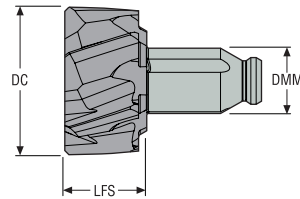

- Per la scelta della geometria, vedere le pagine 338-341
- Per i parametri di taglio raccomandati, vedere pagina(e) 360-367

Codice di ordinazione	Codice prodotto	DC	Dimensione della punta*			LFS	DMM	Dimensione stelo	Geometrie			Qualità				
			mm	mm					mm	mm	EB45	EB45	EB30	H15	CP20	RX2000
PMX6-8H7-EB45	03123161	8,0	7,8/7,9	6	6,0	4,5	PMX05-xx	<input checked="" type="checkbox"/>	<input type="checkbox"/>	<input type="checkbox"/>	<input type="checkbox"/>	<input type="checkbox"/>	<input checked="" type="checkbox"/>	-	-	
PMX6-9H7-EB45	03123162	9,0	8,8/8,9	6	6,0	4,5	PMX05-xx	<input checked="" type="checkbox"/>	<input type="checkbox"/>	<input type="checkbox"/>	<input type="checkbox"/>	<input type="checkbox"/>	<input checked="" type="checkbox"/>	-	-	
PMX6-10H7-EB45	02965863	10,0	9,8/9,9	6	7,0	6,0	PMX06-xx	<input checked="" type="checkbox"/>	<input type="checkbox"/>	<input type="checkbox"/>	<input type="checkbox"/>	<input type="checkbox"/>	<input checked="" type="checkbox"/>	<input type="checkbox"/>	<input type="checkbox"/>	
PMX6-11H7-EB45	02925776	11,0	10,8/10,9	6	7,0	6,0	PMX06-xx	<input checked="" type="checkbox"/>	<input type="checkbox"/>	<input type="checkbox"/>	<input type="checkbox"/>	<input type="checkbox"/>	<input checked="" type="checkbox"/>	<input type="checkbox"/>	<input type="checkbox"/>	
PMX6-12H7-EB45	02925777	12,0	11,8/11,908	6	7,0	6,0	PMX06-xx	<input checked="" type="checkbox"/>	<input type="checkbox"/>	<input type="checkbox"/>	<input type="checkbox"/>	<input type="checkbox"/>	<input checked="" type="checkbox"/>	<input type="checkbox"/>	<input type="checkbox"/>	
PMX6-13H7-EB45	02925778	13,0	12,8/12,9	6	7,0	6,0	PMX06-xx	<input checked="" type="checkbox"/>	<input type="checkbox"/>	<input type="checkbox"/>	<input type="checkbox"/>	<input type="checkbox"/>	<input checked="" type="checkbox"/>	<input type="checkbox"/>	<input type="checkbox"/>	
PMX6-14H7-EB45	02925779	14,0	13,8/13,891	6	7,0	6,0	PMX06-xx	<input checked="" type="checkbox"/>	<input type="checkbox"/>	<input type="checkbox"/>	<input type="checkbox"/>	<input type="checkbox"/>	<input checked="" type="checkbox"/>	<input type="checkbox"/>	<input type="checkbox"/>	
PMX6-15H7-EB45	02925780	15,0	14,8/14,9	6	10,0	8,0	PMX08-xx	<input checked="" type="checkbox"/>	<input type="checkbox"/>	<input type="checkbox"/>	<input type="checkbox"/>	<input type="checkbox"/>	<input checked="" type="checkbox"/>	<input type="checkbox"/>	<input type="checkbox"/>	
PMX6-16H7-EB45	02925781	16,0	15,8/15,9	6	10,0	8,0	PMX08-xx	<input checked="" type="checkbox"/>	<input type="checkbox"/>	<input type="checkbox"/>	<input type="checkbox"/>	<input type="checkbox"/>	<input checked="" type="checkbox"/>	<input type="checkbox"/>	<input type="checkbox"/>	
PMX6-17H7-EB45	02925782	17,0	16,8/16,9	6	10,0	8,0	PMX08-xx	<input checked="" type="checkbox"/>	<input type="checkbox"/>	<input type="checkbox"/>	<input type="checkbox"/>	<input type="checkbox"/>	<input checked="" type="checkbox"/>	<input type="checkbox"/>	<input type="checkbox"/>	
PMX6-18H7-EB45	02925783	18,0	17,8/17,9	6	10,0	8,0	PMX08-xx	<input checked="" type="checkbox"/>	<input type="checkbox"/>	<input type="checkbox"/>	<input type="checkbox"/>	<input type="checkbox"/>	<input checked="" type="checkbox"/>	<input type="checkbox"/>	<input type="checkbox"/>	
PMX6-19H7-EB45	02925784	19,0	18,8/18,9	6	10,0	8,0	PMX08-xx	<input checked="" type="checkbox"/>	<input type="checkbox"/>	<input type="checkbox"/>	<input type="checkbox"/>	<input type="checkbox"/>	<input checked="" type="checkbox"/>	<input type="checkbox"/>	<input type="checkbox"/>	
PMX6-20H7-EB45	02925785	20,0	19,8/19,9	6	10,0	8,0	PMX08-xx	<input checked="" type="checkbox"/>	<input type="checkbox"/>	<input type="checkbox"/>	<input type="checkbox"/>	<input type="checkbox"/>	<input checked="" type="checkbox"/>	<input type="checkbox"/>	<input type="checkbox"/>	
PMX6-21H7-EB45	02925786	21,0	20,8/20,9	6	10,0	8,0	PMX08-xx	<input checked="" type="checkbox"/>	<input type="checkbox"/>	<input type="checkbox"/>	<input type="checkbox"/>	<input type="checkbox"/>	<input checked="" type="checkbox"/>	<input type="checkbox"/>	<input type="checkbox"/>	
PMX6-22H7-EB45	02925030	22,0	21,8/21,9	8	12,0	12,0	PMX12-xx	<input checked="" type="checkbox"/>	<input type="checkbox"/>	<input type="checkbox"/>	<input type="checkbox"/>	<input type="checkbox"/>	<input checked="" type="checkbox"/>	<input type="checkbox"/>	<input type="checkbox"/>	
PMX6-23H7-EB45	02925031	23,0	22,8/22,9	8	12,0	12,0	PMX12-xx	<input checked="" type="checkbox"/>	<input type="checkbox"/>	<input type="checkbox"/>	<input type="checkbox"/>	<input type="checkbox"/>	<input checked="" type="checkbox"/>	<input type="checkbox"/>	<input type="checkbox"/>	
PMX6-24H7-EB45	02925032	24,0	23,813/23,9	8	12,0	12,0	PMX12-xx	<input checked="" type="checkbox"/>	<input type="checkbox"/>	<input type="checkbox"/>	<input type="checkbox"/>	<input type="checkbox"/>	<input checked="" type="checkbox"/>	<input type="checkbox"/>	<input type="checkbox"/>	
PMX6-25H7-EB45	02925033	25,0	24,8/24,9	8	12,0	12,0	PMX12-xx	<input checked="" type="checkbox"/>	<input type="checkbox"/>	<input type="checkbox"/>	<input type="checkbox"/>	<input type="checkbox"/>	<input checked="" type="checkbox"/>	<input type="checkbox"/>	<input type="checkbox"/>	
PMX6-26H7-EB45	02925034	26,0	25,8/25,9	8	12,0	12,0	PMX12-xx	<input checked="" type="checkbox"/>	<input type="checkbox"/>	<input type="checkbox"/>	<input type="checkbox"/>	<input type="checkbox"/>	<input checked="" type="checkbox"/>	<input type="checkbox"/>	<input type="checkbox"/>	
PMX6-27H7-EB45	02925035	27,0	26,8/26,9	8	12,0	12,0	PMX12-xx	<input checked="" type="checkbox"/>	<input type="checkbox"/>	<input type="checkbox"/>	<input type="checkbox"/>	<input type="checkbox"/>	<input checked="" type="checkbox"/>	<input type="checkbox"/>	<input type="checkbox"/>	
PMX6-28H7-EB45	02925036	28,0	27,8/27,9	8	12,0	12,0	PMX12-xx	<input checked="" type="checkbox"/>	<input type="checkbox"/>	<input type="checkbox"/>	<input type="checkbox"/>	<input type="checkbox"/>	<input checked="" type="checkbox"/>	<input type="checkbox"/>	<input type="checkbox"/>	
PMX6-29H7-EB45	02925037	29,0	28,8/28,9	8	12,0	12,0	PMX12-xx	<input checked="" type="checkbox"/>	<input type="checkbox"/>	<input type="checkbox"/>	<input type="checkbox"/>	<input type="checkbox"/>	<input checked="" type="checkbox"/>	<input type="checkbox"/>	<input type="checkbox"/>	
PMX6-30H7-EB45	02925038	30,0	29,8/29,9	8	12,0	12,0	PMX12-xx	<input checked="" type="checkbox"/>	<input type="checkbox"/>	<input type="checkbox"/>	<input type="checkbox"/>	<input type="checkbox"/>	<input checked="" type="checkbox"/>	<input type="checkbox"/>	<input type="checkbox"/>	
PMX6-31H7-EB45	02925039	31,0	30,8/30,9	8	12,0	12,0	PMX12-xx	<input checked="" type="checkbox"/>	<input type="checkbox"/>	<input type="checkbox"/>	<input type="checkbox"/>	<input type="checkbox"/>	<input checked="" type="checkbox"/>	<input type="checkbox"/>	<input type="checkbox"/>	
PMX6-32H7-EB45	02925040	32,0	31,8/31,9	8	12,0	12,0	PMX12-xx	<input checked="" type="checkbox"/>	<input type="checkbox"/>	<input type="checkbox"/>	<input type="checkbox"/>	<input type="checkbox"/>	<input checked="" type="checkbox"/>	<input type="checkbox"/>	<input type="checkbox"/>	

*Per ulteriori informazioni su quale punta scegliere e su come utilizzarla, vedere le pagine 8

Prodotto standard a stock Prodotto standard non a stock.

Codoli per fori ciechi e passanti

Ø 7,75-60,500 mm / 0.305-2.381"

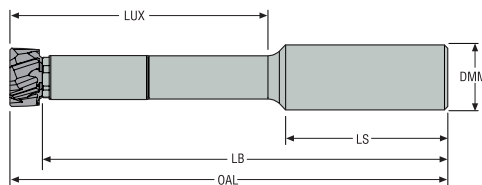

- Per la scelta della geometria, vedere le pagine 338-341
- Per i parametri di taglio raccomandati, vedere pagina(e) 360-367



Code di ordinazione	Codice prodotto	Materiale del codolo	DC	OAL	LB	LS	LUX	DMM
			mm	mm	mm	mm	mm	mm
PMX05-02800-10N1	03123012	Acciaio	7,75 - 9,9	69,0	63,0	40,0	28,0	10,0
PMX05-04100-10N1	02929923	Acciaio	7,75 - 9,9	84,0	78,0	40,0	41,0	10,0
PMX05-10000-10N1	03123013	Acciaio	7,75 - 9,9	143,0	137,0	40,0	100,0	10,0
PMX06-03700-12N1	02925828	Acciaio	9,901 - 14,499	84,0	77,0	45,0	37,0	12,0
PMX06-05700-12N1	02925829	Acciaio	9,901 - 14,499	104,0	97,0	45,0	57,0	12,0
PMX06-12000-12N1	02925830	Acciaio	9,901 - 14,499	167,0	160,0	45,0	120,0	12,0
PMX06HM-12000-12N1	02925831	Metallo duro	9,901 - 14,499	167,0	160,0	45,0	120,0	12,0
PMX08-04600-20N1	02925832	Acciaio	14,5 - 21,499	99,0	89,0	50,0	46,0	20,0
PMX08-08200-20N1	02925833	Acciaio	14,5 - 21,499	135,0	125,0	50,0	82,0	20,0
PMX08-14500-20N1	02925834	Acciaio	14,5 - 21,499	198,0	188,0	50,0	145,0	20,0
PMX08HM-14500-20N1	02925835	Metallo duro	14,5 - 21,499	198,0	188,0	50,0	145,0	20,0
PMX12-06800-25N1	02925836	Acciaio	21,5 - 32,499	127,0	115,0	56,0	68,0	25,0
PMX12-10400-25N1	02925837	Acciaio	21,5 - 32,499	163,0	151,0	56,0	104,0	25,0
PMX12-17000-25N1	02925838	Acciaio	21,5 - 32,499	229,0	217,0	56,0	170,0	25,0
PMX12HM-17000-25N1	02925839	Metallo duro	21,5 - 32,499	229,0	217,0	56,0	170,0	25,0
PMX16-06300-32N1	02925840	Acciaio	32,5 - 60,5	124,0	110,0	60,0	63,0	32,0
PMX16-12700-32N1	02925841	Acciaio	32,5 - 60,5	188,0	174,0	60,0	127,0	32,0
PMX16-17000-32N1	02925842	Acciaio	32,5 - 60,5	231,0	217,0	60,0	170,0	32,0
PMX16HM-17000-32N1	02925843	Metallo duro	32,5 - 60,5	231,0	217,0	61,0	170,0	32,0

Parti di ricambio, comprese nella fornitura

Per codolo	Per Ø (mm)	Chiave per vite staffa	Kit di bloccaggio	Kit refrigerante	Tappo, filettato, foro cieco	Tappo, filettato, foro passante
PMX05	7,75-9,900	1.5SMS795	PMX05-CLKI	RT05-KI	SB05	ST05
PMX06	9,901-14,499	2SMS795	PMX06-CLKI	RT06-KI	SB06	ST06
PMX08	14,5-21,499	2.5SMS795	PMX08-CLKI	RT08-KI	SB08	ST08
PMX12	21,5-32,499	4SMS795	PMX12-CLKI	RT12-KI	SB12	ST12
PMX16	32,5-60	5SMS795	PMX16-CLKI	-	SB16	ST16

* Ricambi solo per steli PMX16. Per PMX16, le viti vengono utilizzate anche per il serraggio.

Accessori

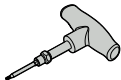
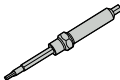
Per Ø (mm)	Dimensione codolo	Codice prodotto	Chiave dinamometrica	Codice prodotto	Bit sostituibile	Codice prodotto	Chiave dinamometrica	Codice prodotto	Bit sostituibile	Valore di coppia
										
7,750-9,900	PMX05	03178196	H00-1505-27	03178237	H00-1.5-27	-	-	-	-	0,5 Nm
9,901-14,499	PMX06	03178197	H00-2009-33	03178238	H00-2.0-33	-	-	-	-	0,9 Nm
14,500-21,499	PMX08	03178199	H00-2512-40	03178240	H00-2.5-40	-	-	-	-	1,2 Nm
21,500-32,499	PMX12	03178201	H00-4020-60	03178242	H00-4.0-60	-	-	-	-	2,0 Nm
32,500-60,500	PMX16	-	-	-	-	03271887	H00T-5050	02506761	H00T-5,0	5,0 Nm

Introduzione

Foratura

Alesatura

Barenatura

Allegato

Codoli per fori ciechi

Ø 7,75-60,500 mm / 0.305-2.381"

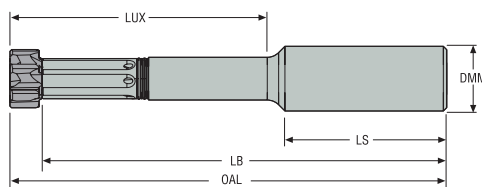

- Per la scelta della geometria, vedere le pagine 338-341
- Per i parametri di taglio raccomandati, vedere pagina(e) 360-367



Codice di ordinazione	Codice prodotto	Materiale del codolo	DC	OAL	LB	LS	LUX	DMM
			mm	mm	mm	mm	mm	mm
PMX05B-02800-10N1	03144322	Acciaio	7,75 - 9,9	69,0	63,0	40,0	28,0	10,0
PMX05B-04100-10N1	03144323	Acciaio	7,75 - 9,9	84,0	78,0	40,0	41,0	10,0
PMX05B-10000-10N1	03144324	Acciaio	7,75 - 9,9	143,0	137,0	40,0	100,0	10,0
PMX06B-03700-12N1	03075433	Acciaio	9,901 - 14,499	84,0	77,0	45,0	37,0	12,0
PMX06B-05700-12N1	03075434	Acciaio	9,901 - 14,499	104,0	97,0	45,0	57,0	12,0
PMX06B-12000-12N1	03075435	Acciaio	9,901 - 14,499	167,0	160,0	45,0	120,0	12,0
PMX06BHM-12000-12N1	03075436	Metallo duro	9,901 - 14,499	167,0	160,0	45,0	120,0	12,0
PMX08B-04600-20N1	03075437	Acciaio	14,5 - 21,499	99,0	89,0	50,0	46,0	20,0
PMX08B-08200-20N1	03075438	Acciaio	14,5 - 21,499	135,0	125,0	50,0	82,0	20,0
PMX08B-14500-20N1	03075439	Acciaio	14,5 - 21,499	198,0	188,0	50,0	145,0	20,0
PMX08BHM-14500-20N1	03075440	Metallo duro	14,5 - 21,499	198,0	188,0	50,0	145,0	20,0
PMX12B-06800-25N1	03075441	Acciaio	21,5 - 32,499	127,0	115,0	56,0	68,0	25,0
PMX12B-10400-25N1	03075442	Acciaio	21,5 - 32,499	163,0	151,0	56,0	104,0	25,0
PMX12B-17000-25N1	03075443	Acciaio	21,5 - 32,499	229,0	217,0	56,0	170,0	25,0
PMX12BHM-17000-25N1	03075444	Metallo duro	21,5 - 32,499	229,0	217,0	56,0	170,0	25,0
PMX16B-06300-32N1	03075445	Acciaio	32,5 - 60,5	124,0	110,0	61,0	63,0	32,0
PMX16B-12700-32N1	03075446	Acciaio	32,5 - 60,5	188,0	174,0	61,0	127,0	32,0
PMX16B-17000-32N1	03075447	Acciaio	32,5 - 60,5	231,0	217,0	61,0	170,0	32,0
PMX16BHM-17000-32N1	03075448	Metallo duro	32,5 - 60,5	231,0	217,0	61,0	170,0	32,0

Parti di ricambio, comprese nella fornitura

Per codolo	Per Ø (mm)	Chiave per vite staffa	Kit di bloccaggio	Tappo, filettato, foro cieco
PMX05B	7,75-9,900	1.5SMS795	PMX05-CLKI	SB05
PMX06B	9,901-14,499	2SMS795	PMX06-CLKI	SB06
PMX08B	14,500-21,499	2.5SMS795	PMX08-CLKI	SB08
PMX12B	21,500-32,499	4SMS795	PMX12-CLKI	SB12
PMX16B	32,500-60,000	5SMS795	PMX16-CLKI	SB16

* Ricambi solo per steli PMX16. Per PMX16, le viti vengono utilizzate anche per il serraggio.

Accessori

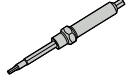
Per Ø (mm)	Dimensione codolo	Codice prodotto	Chiave dinamometrica	Codice prodotto	Bit sostituibile	Codice prodotto	Chiave dinamometrica	Codice prodotto	Bit sostituibile	Valore di coppia
										
7,750-9,900	PMX05	03178196	H00-1505-27	03178237	H00-1.5-27	-	-	-	-	0,5 Nm
9,901-14,499	PMX06	03178197	H00-2009-33	03178238	H00-2.0-33	-	-	-	-	0,9 Nm
14,500-21,499	PMX08	03178199	H00-2512-40	03178240	H00-2.5-40	-	-	-	-	1,2 Nm
21,500-32,499	PMX12	03178201	H00-4020-60	03178242	H00-4.0-60	-	-	-	-	2,0 Nm
32,500-60,500	PMX16	-	-	-	-	03271887	H00T-5050	02506761	H00T-5,0	5,0 Nm

Introduzione

Foratura

Alesatura

Barenatura

Allegato

Codoli regolabili per fori passanti

∅ 7,75-60,500 mm / 0.305-2.381"

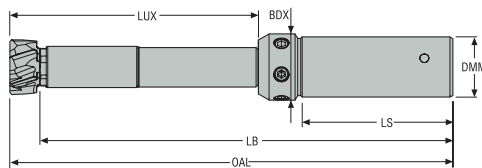

- Per la scelta della geometria, vedere le pagine 338-341
- Per i parametri di taglio raccomandati, vedere pagina(e) 360-367

Codice di ordinazione	Codice prodotto	DC	OAL	LB	LS	LUX	DMM
		mm	mm	mm	mm	mm	mm
PMX05T-AD-04100-16N1	03271918	7,75 - 9,9	102,0	96,0	48,0	41,0	16,0
PMX06T-AD-05700-16N1	03002833	9,901 - 14,499	117,0	110,0	48,0	57,0	16,0
PMX08T-AD-08200-20N1	03002835	14,5 - 21,499	147,0	137,0	50,0	82,0	20,0
PMX12T-AD-10400-25N1	03002837	21,5 - 32,499	179,0	167,0	56,0	104,0	25,0
PMX16T-AD-12700-32N1	03002839	32,5 - 60,5	214,0	200,0	60,0	127,0	32,0

Parti di ricambio, comprese nella fornitura

Per codolo	Per ∅ (mm)	Chiave per vite staffa	Anello addz. refrigerante	Chiave di regolazione	Master per controllo errore di concentricità	Vite di regolazione
PMX05T	7,750-9,900	1.5SMS795	RT05-KI	2SMS795	PMX05-MSTR	HCM4X4X0.5/ISO4026
PMX06T	9,901-14,499	2SMS795	RT06-KI	-	PMX06-MSTR	HCM4X4X0.5/ISO4026
PMX08T	14,50-21,499	2.5SMS795	RT08-KI	-	PMX08-MSTR	HCM5X5X0.5/ISO4026
PMX12T	21,50-32,499	4SMS795	RT12-KI	3SMS795	PMX12-MSTR	HCM6X6X0.75/ISO4026
PMX16T	32,50-60,000	5SMS795	-	3SMS795	-	HCM6X6X0.75/ISO4026

Accessori

Per ∅ (mm)	Dimensione codolo	Codice prodotto	Chiave dinamometrica	Codice prodotto	Bit sostituibile	Codice prodotto	Chiave dinamometrica	Codice prodotto	Bit sostituibile	Valore di coppia
7,750-9,900	PMX05	03178196	H00-1505-27	03178237	H00-1.5-27	-	-	-	-	0,5 Nm
9,901-14,499	PMX06	03178197	H00-2009-33	03178238	H00-2.0-33	-	-	-	-	0,9 Nm
14,500-21,499	PMX08	03178199	H00-2512-40	03178240	H00-2.5-40	-	-	-	-	1,2 Nm
21,500-32,499	PMX12	03178201	H00-4020-60	03178242	H00-4.0-60	-	-	-	-	2,0 Nm
32,500-60,500	PMX16	-	-	-	-	03271887	H00T-5050	02506761	H00T-5,0	5,0 Nm

Nota: Il kit staffa per riparazione PMxx-CLKI non è adatto per gli steli PMX FL & AD

Codoli regolabili per fori ciechi

Ø 7,75-60,500 mm / 0.305-2.381"

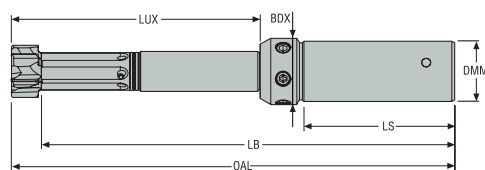

- Per la scelta della geometria, vedere le pagine 338-341
- Per i parametri di taglio raccomandati, vedere pagina(e) 360-367

Codice di ordinazione	Codice prodotto	DC	OAL	LB	LS	LUX	DMM
		mm	mm	mm	mm	mm	mm
PMX05B-AD-04100-16N1	03271919	7,75 - 9,9	102,0	96,0	48,0	41,0	16,0
PMX06B-AD-05700-16N1	03002834	9,901 - 14,499	117,0	110,0	48,0	57,0	16,0
PMX08B-AD-08200-20N1	03002836	14,5 - 21,499	147,0	137,0	50,0	82,0	20,0
PMX12B-AD-10400-25N1	03002838	21,5 - 32,499	179,0	167,0	56,0	104,0	25,0
PMX16B-AD-12700-32N1	03002840	32,5 - 60,5	214,0	200,0	60,0	127,0	32,0

Parti di ricambio, comprese nella fornitura

Per codolo	Per Ø (mm)	Chiave per vite staffa	Chiave di regolazione	Master per controllo errore di concentricità	Vite di regolazione
PMX05B	7,750-9,900	1.5SMS795	2SMS795	PMX05-MSTR	HCM4X4X0.5/ISO4026
PMX06B	9,901-14,499	2SMS795	-	PMX06-MSTR	HCM4X4X0.5/ISO4026
PMX08B	14,50-21,499	2.5SMS795	-	PMX08-MSTR	HCM5X5X0.5/ISO4026
PMX12B	21,50-32,499	4SMS795	3SMS795	PMX12-MSTR	HCM6X6X0.75/ISO4026
PMX16B	32,50-60,000	5SMS795	3SMS795	-	HCM6X6X0.75/ISO4026

Accessori

Per Ø (mm)	Dimensione codolo	Codice prodotto	Chiave dinamometrica	Codice prodotto	Bit sostituibile	Codice prodotto	Chiave dinamometrica	Codice prodotto	Bit sostituibile	Valore di coppia
7,750-9,900	PMX05	03178196	H00-1505-27	03178237	H00-1.5-27	-	-	-	-	0,5 Nm
9,901-14,499	PMX06	03178197	H00-2009-33	03178238	H00-2.0-33	-	-	-	-	0,9 Nm
14,500-21,499	PMX08	03178199	H00-2512-40	03178240	H00-2.5-40	-	-	-	-	1,2 Nm
21,500-32,499	PMX12	03178201	H00-4020-60	03178242	H00-4.0-60	-	-	-	-	2,0 Nm
32,500-60,500	PMX16	-	-	-	-	03271887	H00T-5050	02506761	H00T-5,0	5,0 Nm

Nota: Il kit staffa per riparazione PMxx-CLKI non è adatto per gli steli PMX FL & AD

Codoli flottanti per fori passanti

Ø 7,75-60,500 mm / 0.305-2.381"

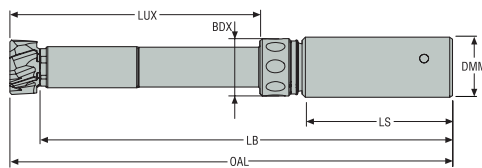

- Per la scelta della geometria, vedere le pagine 338-341
- Per i parametri di taglio raccomandati, vedere pagina(e) 360-367

Codice di ordinazione	Codice prodotto	DC	OAL	LB	LS	LUX	DMM
		mm	mm	mm	mm	mm	mm
PMX05T-FL-04100-16N1	03197751	7,75 - 9,9	102,0	96,0	48,0	41,0	16,0
PMX06T-FL-05700-16N1	03002825	9,901 - 14,499	117,0	110,0	48,0	57,0	16,0
PMX08T-FL-08200-20N1	03002827	14,5 - 21,499	147,0	137,0	50,0	82,0	20,0
PMX12T-FL-10400-25N1	03002829	21,5 - 32,499	179,0	167,0	56,0	104,0	25,0
PMX16T-FL-12700-32N1	03002831	32,5 - 60,5	214,0	200,0	60,0	127,0	32,0

Parti di ricambio, comprese nella fornitura

Per codolo	Per Ø (mm)	Chiave per vite staffa	Anello addz. refrigerante
PMX05T	7,750-9,900	1.5SMS795	RT05-KI
PMX06T	9,901-14,499	2SMS795	RT06-KI
PMX08T	14,50-21,499	2.5SMS795	RT08-KI
PMX12T	21,50-32,499	4SMS795	RT12-KI
PMX16T	32,50-60,000	5SMS795	-

Accessori

Per Ø (mm)	Dimensione codolo	Codice prodotto	Chiave dinamometrica	Codice prodotto	Bit sostituibile	Codice prodotto	Chiave dinamometrica	Codice prodotto	Bit sostituibile	Valore di coppia
7,750-9,900	PMX05	03178196	H00-1505-27	03178237	H00-1.5-27	-	-	-	-	0,5 Nm
9,901-14,499	PMX06	03178197	H00-2009-33	03178238	H00-2.0-33	-	-	-	-	0,9 Nm
14,500-21,499	PMX08	03178199	H00-2512-40	03178240	H00-2.5-40	-	-	-	-	1,2 Nm
21,500-32,499	PMX12	03178201	H00-4020-60	03178242	H00-4.0-60	-	-	-	-	2,0 Nm
32,500-60,500	PMX16	-	-	-	-	03271887	H00T-5050	02506761	H00T-5,0	5,0 Nm

Nota: Il kit staffa per riparazione PMxx-CLKI non è adatto per gli steli PMX FL & AD

Codoli flottanti per fori ciechi

Ø 7,75-60,500 mm / 0.305-2.381"

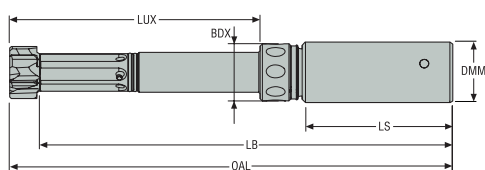

- Per la scelta della geometria, vedere le pagine 338-341
- Per i parametri di taglio raccomandati, vedere pagina(e) 360-367

Codice di ordinazione	Codice prodotto	DC	OAL	LB	LS	LUX	DMM
		mm	mm	mm	mm	mm	mm
PMX05B-FL-04100-16N1	03271916	7,75 - 9,9	102,0	96,0	48,0	41,0	16,0
PMX06B-FL-05700-16N1	03002826	9,901 - 14,499	117,0	110,0	48,0	57,0	16,0
PMX08B-FL-08200-20N1	03002828	14,5 - 21,499	147,0	137,0	50,0	82,0	20,0
PMX12B-FL-10400-25N1	03002830	21,5 - 32,499	179,0	167,0	56,0	104,0	25,0
PMX16B-FL-12700-32N1	03002832	32,5 - 60,5	214,0	200,0	60,0	127,0	32,0

Parti di ricambio, comprese nella fornitura

Per codolo	Per Ø (mm)	Chiave per vite staffa
PMX05B	7,750-9,900	1.5SMS795
PMX06B	9,901-14,499	2SMS795
PMX08B	14,50-21,499	2.5SMS795
PMX12B	21,50-32,499	4SMS795
PMX16B	32,50-60,500	5SMS795

Accessori

Per Ø (mm)	Dimensione codolo	Codice prodotto	Chiave dinamometrica	Codice prodotto	Bit sostituibile	Codice prodotto	Chiave dinamometrica	Codice prodotto	Bit sostituibile	Valore di coppia
7,750-9,900	PMX05	03178196	H00-1505-27	03178237	H00-1.5-27	-	-	-	-	0,5 Nm
9,901-14,499	PMX06	03178197	H00-2009-33	03178238	H00-2.0-33	-	-	-	-	0,9 Nm
14,500-21,499	PMX08	03178199	H00-2512-40	03178240	H00-2.5-40	-	-	-	-	1,2 Nm
21,500-32,499	PMX12	03178201	H00-4020-60	03178242	H00-4.0-60	-	-	-	-	2,0 Nm
32,500-60,500	PMX16	-	-	-	-	03271887	H00T-5050	02506761	H00T-5,0	5,0 Nm

Nota: Il kit staffa per riparazione PMxx-CLKI non è adatto per gli steli PMX FL & AD

Teste per fori passanti e ciechi, Utensili speciali

Ø 7,75-60,500 mm / 0.305-2.381"

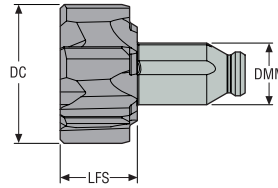

- Per la scelta della geometria, vedere le pagine 338-341
- Per i parametri di taglio raccomandati, vedere pagina(e) 360-367

Codice di ordinazione	DCN	DCX	LFS	DMM	Dimensione stelo	Geometrie	Qualità												
	mm Inch	mm Inch	mm Inch	mm Inch				H15	CP20	RX2000	RK2050	RK1550	CF	RX1500	RN2010	RM2020	RM2090	RS2090	
PMX5-7.75-XX-XXXX	7,75 0.305	9,9 0.390	6,0 0.236	4,5 0.177	6	PMX05-xx	EB45 EB845 EB30	<input type="checkbox"/>	<input type="checkbox"/>	<input type="checkbox"/>	<input type="checkbox"/>	<input type="checkbox"/>	-	-	<input type="checkbox"/>	<input type="checkbox"/>	<input type="checkbox"/>	<input type="checkbox"/>	<input type="checkbox"/>
PMX5-10.0-XX-XXXX	9,901 0.390	14,499 0.571	7,0 0.276	6,0 0.236	6	PMX06-xx	EB45 EB845 EB30	<input type="checkbox"/>	<input type="checkbox"/>	<input type="checkbox"/>	<input type="checkbox"/>	<input type="checkbox"/>	<input type="checkbox"/>	<input type="checkbox"/>	<input type="checkbox"/>	<input type="checkbox"/>	<input type="checkbox"/>	<input type="checkbox"/>	<input type="checkbox"/>
PMX5-14.5-XX-XXXX	14,5 0.571	21,499 0.846	10,0 0.394	8,0 0.315	6	PMX08-xx	EB45 EB845 EB30	<input type="checkbox"/>	<input type="checkbox"/>	<input type="checkbox"/>	<input type="checkbox"/>	<input type="checkbox"/>	<input type="checkbox"/>	<input type="checkbox"/>	<input type="checkbox"/>	<input type="checkbox"/>	<input type="checkbox"/>	<input type="checkbox"/>	<input type="checkbox"/>
PMX5-21.5-XX-XXXX	21,5 0.846	32,499 1.279	12,0 0.472	12,0 0.472	8	PMX12-XX	EB45 EB845 EB30	<input type="checkbox"/>	<input type="checkbox"/>	<input type="checkbox"/>	<input type="checkbox"/>	<input type="checkbox"/>	<input type="checkbox"/>	<input type="checkbox"/>	<input type="checkbox"/>	<input type="checkbox"/>	<input type="checkbox"/>	<input type="checkbox"/>	<input type="checkbox"/>
PMX5-32.5-XX-XXXX	32,5 1.280	60,5 2.382	14,0 0.551	16,0 0.630	10	PMX16-xx	EB45 EB845 EB30	<input type="checkbox"/>	<input type="checkbox"/>	<input type="checkbox"/>	<input type="checkbox"/>	<input type="checkbox"/>	<input type="checkbox"/>	<input type="checkbox"/>	<input type="checkbox"/>	<input type="checkbox"/>	<input type="checkbox"/>	<input type="checkbox"/>	<input type="checkbox"/>

= Prodotto standard non presente a magazzino.

Nota: Quando si ordinano alesatori Precimaster Plus per diametri intermedi, indicare il diametro e la tolleranza del foro da alesare.

Esempio d'ordine: PMX5-16.515 P7-EB45 RM2020.

Teste per fori passanti, Utensili speciali

Ø 7,75-60,500 mm / 0.305-2.381"

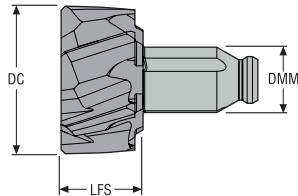

- Per la scelta della geometria, vedere le pagine 338-341
- Per i parametri di taglio raccomandati, vedere pagina(e) 360-367

Codice di ordinazione	DCN	DCX	LFS	DMM	Dimensione stelo	Geometrie	Qualità												
	mm Inch	mm Inch	mm Inch	mm Inch				H15	CP20	RX2000	RK2050	RK1550	CF	RX1500	RN2010	RM2020	RM2090	RS2090	
PMX6-7.75-XX-XXXX	7,75 0.305	9,9 0.390	6,0 0.236	4,5 0.177	6	PMX05-xx	EB45 EB845 EB30	<input type="checkbox"/>	<input type="checkbox"/>	<input type="checkbox"/>	<input type="checkbox"/>	<input type="checkbox"/>	-	-	<input type="checkbox"/>	<input type="checkbox"/>	<input type="checkbox"/>	<input type="checkbox"/>	<input type="checkbox"/>
PMX6-10.0-XX-XXXX	9,901 0.390	14,499 0.571	7,0 0.276	6,0 0.236	6	PMX06-xx	EB45 EB845 EB30	<input type="checkbox"/>	<input type="checkbox"/>	<input type="checkbox"/>	<input type="checkbox"/>	<input type="checkbox"/>	<input type="checkbox"/>	<input type="checkbox"/>	<input type="checkbox"/>	<input type="checkbox"/>	<input type="checkbox"/>	<input type="checkbox"/>	<input type="checkbox"/>
PMX6-14.5-XX-XXXX	14,5 0.571	21,499 0.846	10,0 0.394	8,0 0.315	6	PMX08-xx	EB45 EB845 EB30	<input type="checkbox"/>	<input type="checkbox"/>	<input type="checkbox"/>	<input type="checkbox"/>	<input type="checkbox"/>	<input type="checkbox"/>	<input type="checkbox"/>	<input type="checkbox"/>	<input type="checkbox"/>	<input type="checkbox"/>	<input type="checkbox"/>	<input type="checkbox"/>
PMX6-21.5-XX-XXXX	21,5 0.846	32,499 1.279	12,0 0.472	12,0 0.472	8	PMX12-XX	EB45 EB845 EB30	<input type="checkbox"/>	<input type="checkbox"/>	<input type="checkbox"/>	<input type="checkbox"/>	<input type="checkbox"/>	<input type="checkbox"/>	<input type="checkbox"/>	<input type="checkbox"/>	<input type="checkbox"/>	<input type="checkbox"/>	<input type="checkbox"/>	<input type="checkbox"/>
PMX6-32.5-XX-XXXX	32,5 1.280	60,5 2.382	14,0 0.551	16,0 0.630	10	PMX16-xx	EB45 EB845 EB30	<input type="checkbox"/>	<input type="checkbox"/>	<input type="checkbox"/>	<input type="checkbox"/>	<input type="checkbox"/>	<input type="checkbox"/>	<input type="checkbox"/>	<input type="checkbox"/>	<input type="checkbox"/>	<input type="checkbox"/>	<input type="checkbox"/>	<input type="checkbox"/>

= Prodotto standard non presente a magazzino.

Nota: Quando si ordinano alesatori Precimaster Plus per diametri intermedi, indicare il diametro e la tolleranza del foro da alesare.

Esempio d'ordine: PMX6-16.515 P7-EB45 RM2020.

Teste per fori ciechi, Utensili speciali

Ø 7,75-60,500 mm / 0.305-2.381"

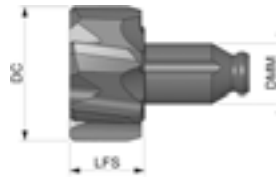

- Per la scelta della geometria, vedere le pagine 338-341
- Per i parametri di taglio raccomandati, vedere pagina(e) 360-367

Codice di ordinazione	DCN	DCX	LFS	DMM	Dimensione stelo	Geometrie	Qualità												
	mm Inch	mm Inch	mm Inch	mm Inch				H15	CP20	RX2000	RK2050	RK1550	CF	RX1500	RN2010	RM2020	RM2090	RS2090	
PMX4-7.75-XX-XXXX	7,75 0.305	9,9 0.390	6,0 0.236	4,5 0.177	6	PMX05-xx	EB45 EB84 EB30	<input type="checkbox"/>	<input type="checkbox"/>	<input type="checkbox"/>	<input type="checkbox"/>	<input type="checkbox"/>	-	-	<input type="checkbox"/>	<input type="checkbox"/>	<input type="checkbox"/>	<input type="checkbox"/>	<input type="checkbox"/>
PMX4-10.0-XX-XXXX	9,901 0.390	14,499 0.571	7,0 0.276	6,0 0.236	6	PMX06-xx	EB45 EB84 EB30	<input type="checkbox"/>	<input type="checkbox"/>	<input type="checkbox"/>	<input type="checkbox"/>	<input type="checkbox"/>	<input type="checkbox"/>	<input type="checkbox"/>	<input type="checkbox"/>	<input type="checkbox"/>	<input type="checkbox"/>	<input type="checkbox"/>	<input type="checkbox"/>
PMX4-14.5-XX-XXXX	14,5 0.571	21,499 0.846	10,0 0.394	8,0 0.315	6	PMX08-xx	EB45 EB84 EB30	<input type="checkbox"/>	<input type="checkbox"/>	<input type="checkbox"/>	<input type="checkbox"/>	<input type="checkbox"/>	<input type="checkbox"/>	<input type="checkbox"/>	<input type="checkbox"/>	<input type="checkbox"/>	<input type="checkbox"/>	<input type="checkbox"/>	<input type="checkbox"/>
PMX4-21.5-XX-XXXX	21,5 0.846	32,499 1.279	12,0 0.472	12,0 0.472	8	PMX12-xx	EB45 EB84 EB30	<input type="checkbox"/>	<input type="checkbox"/>	<input type="checkbox"/>	<input type="checkbox"/>	<input type="checkbox"/>	<input type="checkbox"/>	<input type="checkbox"/>	<input type="checkbox"/>	<input type="checkbox"/>	<input type="checkbox"/>	<input type="checkbox"/>	<input type="checkbox"/>
PMX4-32.5-XX-XXXX	32,5 1.280	60,5 2.382	14,0 0.551	16,0 0.630	10	PMX16-xx	EB45 EB84 EB30	<input type="checkbox"/>	<input type="checkbox"/>	<input type="checkbox"/>	<input type="checkbox"/>	<input type="checkbox"/>	<input type="checkbox"/>	<input type="checkbox"/>	<input type="checkbox"/>	<input type="checkbox"/>	<input type="checkbox"/>	<input type="checkbox"/>	<input type="checkbox"/>

= Prodotto standard non presente a magazzino.

Nota: Quando si ordinano alesatori Precimaster Plus per diametri intermedi, indicare il diametro e la tolleranza del foro da alesare.

Esempio d'ordine: PMX4-16.515 P7-EB45 RM2020.

Teste espandibili per fori ciechi e passanti

Ø 10,00-32,500 mm / 0.393-1.279"

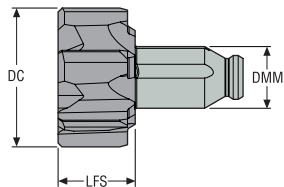

- Per la scelta della geometria, vedere le pagine 338-341
- Per i parametri di taglio raccomandati, vedere pagina(e) 360-367

Codice di ordinazione	DCN	DCX	LFS	DMM	Dimensione stelo	Geometrie	Qualità												
	mm Inch	mm Inch	mm Inch	mm Inch			H15	CP20	RX2000	RK2050	RK1550	CF	RX1500	RN2010	RM2020	RM2090	RS2090		
PMX8-10.0-XX-XXXX	10,0 0.394	14,499 0.571	7,0 0.276	6,0 0.236	6	PMX06-xx	EB45 EB845 EB30	<input type="checkbox"/>	<input type="checkbox"/>	<input type="checkbox"/>	<input type="checkbox"/>	<input type="checkbox"/>	<input type="checkbox"/>	<input type="checkbox"/>	<input type="checkbox"/>	<input type="checkbox"/>	<input type="checkbox"/>	<input type="checkbox"/>	<input type="checkbox"/>
PMX8-14.5-XX-XXXX	14,5 0.571	21,499 0.846	10,0 0.394	8,0 0.315	6	PMX08-xx	EB45 EB845 EB30	<input type="checkbox"/>	<input type="checkbox"/>	<input type="checkbox"/>	<input type="checkbox"/>	<input type="checkbox"/>	<input type="checkbox"/>	<input type="checkbox"/>	<input type="checkbox"/>	<input type="checkbox"/>	<input type="checkbox"/>	<input type="checkbox"/>	<input type="checkbox"/>
PMX8-21.5-XX-XXXX	21,5 0.846	32,499 1.279	12,0 0.472	12,0 0.472	8	PMX12-xx	EB45 EB845 EB30	<input type="checkbox"/>	<input type="checkbox"/>	<input type="checkbox"/>	<input type="checkbox"/>	<input type="checkbox"/>	<input type="checkbox"/>	<input type="checkbox"/>	<input type="checkbox"/>	<input type="checkbox"/>	<input type="checkbox"/>	<input type="checkbox"/>	<input type="checkbox"/>

= Prodotto standard non presente a magazzino.

Nota: Quando si ordinano alesatori Precimaster Plus per diametri intermedi, indicare il diametro e la tolleranza del foro da alesare.

Esempio d'ordine: PMX8-16.515 P7-EB45 RM2020.

Risoluzione dei problemi

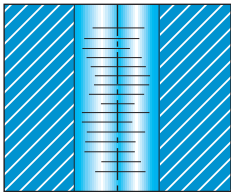
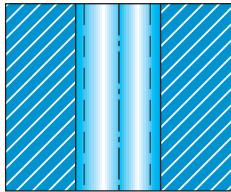
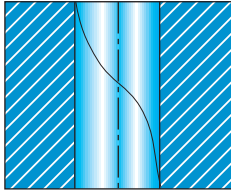
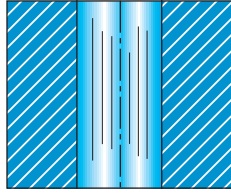
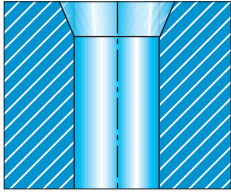
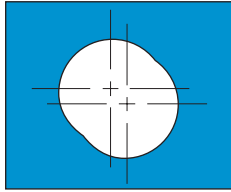
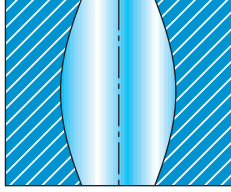
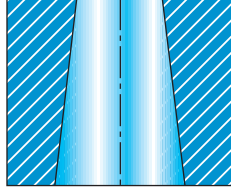
Introduzione	Cattiva finitura superficiale <ul style="list-style-type: none"> • Controllare il sovrametallo • Migliorare le condizioni di lubrificazione (tipo di adduzione, pressione, qualità) • Ridurre l'avanzamento 	Foro maggiorato <ul style="list-style-type: none"> • Migliorare il centraggio (asse alesatore/foro) 
	Rigature di ritorno <ul style="list-style-type: none"> • Migliorare le condizioni di lubrificazione (tipo di adduzione, pressione, qualità) • Migliorare il centraggio (asse alesatore/foro) • Ridurre la velocità di ritorno 	Rigature <ul style="list-style-type: none"> • Migliorare il centraggio (asse alesatore/foro) • Controllare il sovrametallo 
Alesatura	Foro conico all'entrata <ul style="list-style-type: none"> • Ridurre l'avanzamento • Migliorare il centraggio (asse alesatore/foro) • Ridurre l'eccentricità radiale 	Foro fuori centro/ovale <ul style="list-style-type: none"> • Migliorare il serraggio (deformazione del pezzo) • Controllare il sovrametallo • Migliorare il centraggio (asse alesatore/foro) 
	Foro deformato <ul style="list-style-type: none"> • Migliorare il serraggio (deformazione del pezzo) 	Foro conico <ul style="list-style-type: none"> • Migliorare il centraggio (asse alesatore/foro) 
Barenatura		
Allegato		

Istruzioni per la riaffilatura

Specifiche

Mola diamantata
Dimensione grana:
D6 – Per il primo angolo di spoglia (β_1 - β_3)
D64 – Per il secondo angolo di spoglia (β_2)

Importante:

La riaffilatura riduce il diametro dell'alesatore
La riapplicazione del rivestimento può generare un aumento del diametro
Errore di concentricità massimo sugli smussi di imbocco $10\ \mu\text{m}$ ($394\ \mu\text{in}$)

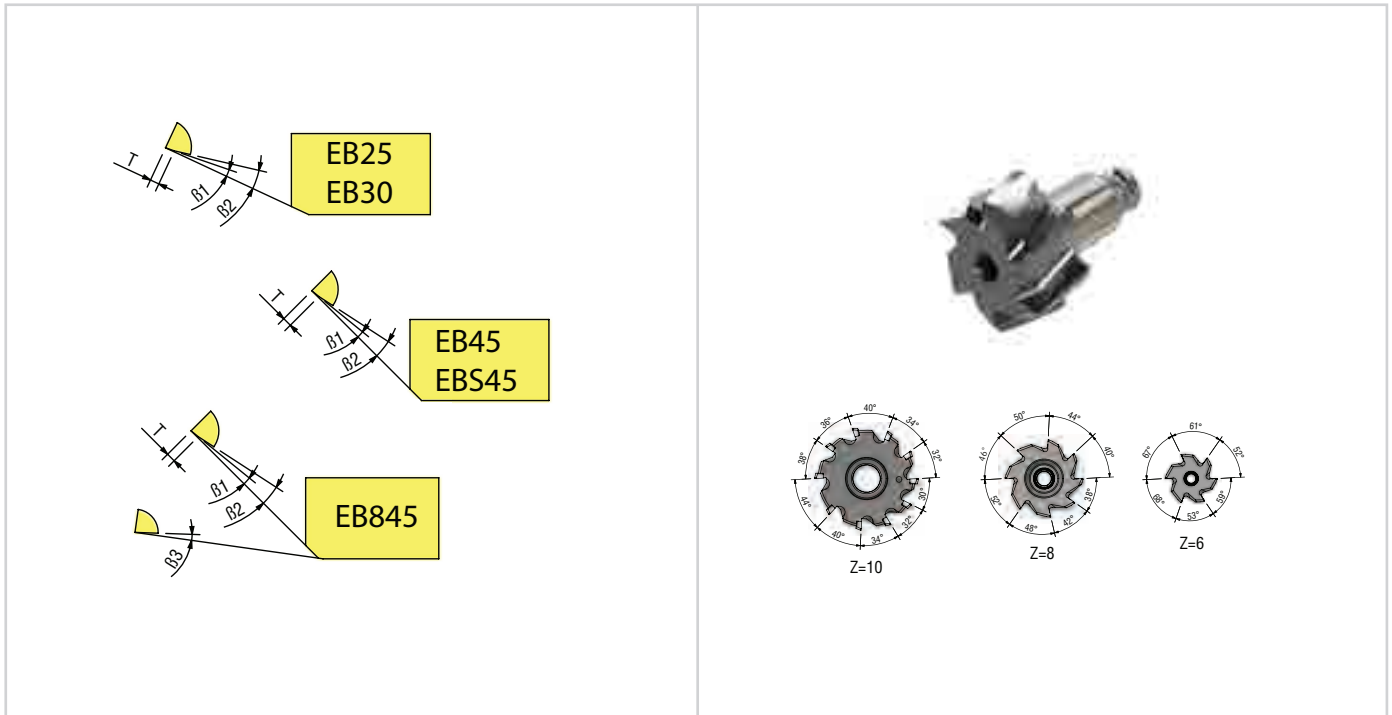

\varnothing Precimaster Plus mm (pollici)	β_1	β_2	β_3	T mm (pollici)
7,75–9,999 (0.3151–0.3937)	8°	18°	8°	0,20 (0.008)
10,00–14,499 (0.3937–0.5708)	8°	18°	8°	0,20 (0.008)
14,500–21,499 (0.5709–0.8464)	8°	18°	8°	0,20 (0.008)
21,500–32,499 (0.8465–1.2795)	8°	18°	8°	0,25 (0.010)
32,500–60,499 (1.2795–2.3819)	8°	15°	8°	0,30 (0.012)

Parametri di taglio – PM Plus... -EB45 misure metriche

SMG		a_p (°)		f			V_c												
		z=6	z=8 z=10	z=6	z=8	z=10	H15	CP20	RX2000	RK2050	CF	RX1500	RK1550	RN2010	RM2020	RM2090	RS2090		
Introduzione	P1	PMXxx .6 .8 -EB45	0,10 -0,20	0,10 -0,30	0,30 -0,90	0,40 -1,20	0,50 -1,50	25 (15-30)	60 (30-100)	80 (30-150)	-	180 (90-200)	220 (120-300)	-	-	-	-	-	
	P2	PMXxx .6 .8 -EB45	0,10 -0,20	0,10 -0,30	0,30 -0,90	0,40 -1,20	0,50 -1,50	25 (15-30)	60 (30-100)	80 (30-150)	-	180 (90-200)	220 (120-300)	-	-	-	-	-	
	P3	PMXxx .6 .8 -EB45	0,10 -0,20	0,10 -0,30	0,30 -0,90	0,40 -1,20	0,50 -1,50	25 (15-30)	60 (30-100)	80 (30-150)	-	180 (90-200)	220 (120-300)	-	-	-	-	-	
	P4	PMXxx .6 .8 -EB45	0,10 -0,20	0,10 -0,30	0,20 -0,70	0,30 -1,00	0,40 -1,20	20 (10-25)	50 (30-80)	60 (30-120)	-	120 (80-150)	180 (90-200)	-	-	-	-	-	
	P5	PMXxx .6 .8 -EB45	0,10 -0,20	0,10 -0,30	0,20 -0,70	0,30 -1,00	0,40 -1,20	20 (10-25)	50 (30-80)	60 (30-120)	-	120 (80-150)	180 (90-200)	-	-	-	-	-	
	P6	PMXxx .6 .8 -EB45	0,10 -0,20	0,10 -0,30	0,20 -0,70	0,30 -1,00	0,40 -1,20	20 (10-25)	50 (30-80)	60 (30-120)	-	120 (80-150)	180 (90-200)	-	-	-	-	-	
	P7	PMXxx .6 .8 -EB45	0,10 -0,20	0,10 -0,30	0,20 -0,70	0,30 -1,00	0,40 -1,20	20 (10-25)	50 (30-80)	60 (30-120)	-	120 (80-150)	180 (90-200)	-	-	-	-	-	
	P8	PMXxx .6 .8 -EB45	0,10 -0,20	0,10 -0,30	0,20 -0,70	0,30 -1,00	0,40 -1,20	15 (10-20)	35 (20-60)	40 (20-80)	-	80 (60-120)	120 (80-180)	-	-	-	-	-	
Foratura	P11	PMXxx .6 .8 -EB45	0,10 -0,20	0,10 -0,30	0,20 -0,70	0,30 -1,00	0,40 -1,20	15 (10-20)	35 (20-60)	40 (20-80)	-	80 (60-120)	120 (80-180)	-	-	-	-	-	
	P12	PMXxx .6 .8 -EB45	0,10 -0,20	0,10 -0,30	0,20 -0,70	0,30 -1,00	0,40 -1,20	12 (8-15)	25 (15-45)	30 (15-65)	-	65 (45-95)	95 (65-145)	-	-	-	-	-	
	M1	PMXxx .6 .8 -EB45	0,08 -0,15	0,10 -0,20	0,20 -0,60	0,30 -0,80	0,40 -1,00	12 (9-15)	25 (15-45)	35 (20-70)	-	-	-	-	-	25 (15-40)	40 (25-80)	-	
	M2	PMXxx .6 .8 -EB45	0,08 -0,15	0,10 -0,20	0,20 -0,60	0,30 -0,80	0,40 -1,00	-	25 (15-45)	35 (20-70)	-	-	-	-	-	25 (15-40)	40 (25-80)	-	
	M3	PMXxx .6 .8 -EB45	0,08 -0,15	0,10 -0,20	0,20 -0,60	0,30 -0,80	0,40 -1,00	-	25 (15-45)	35 (20-70)	-	-	-	-	-	25 (15-40)	40 (25-80)	-	
Alesatura	M4	PMXxx .6 .8 -EB45	0,08 -0,15	0,10 -0,20	0,20 -0,60	0,30 -0,80	0,40 -1,00	-	20 (10-30)	25 (15-50)	-	-	-	-	-	20 (10-30)	30 (20-60)	-	
	M5	PMXxx .6 .8 -EB45	0,08 -0,15	0,10 -0,20	0,20 -0,60	0,30 -0,80	0,40 -1,00	-	20 (10-30)	25 (15-50)	-	-	-	-	-	20 (10-30)	30 (20-60)	-	
	K1	PMXxx .6 .8 -EB45	0,10 -0,20	0,10 -0,25	0,30 -0,90	0,40 -1,20	0,50 -1,50	25 (15-30)	60 (40-100)	80 (30-150)	90 (35-170)	-	220 (120-300)	245 (135-335)	-	-	-	-	
	K2	PMXxx .6 .8 -EB45	0,10 -0,20	0,10 -0,25	0,30 -0,90	0,40 -1,20	0,50 -1,50	-	25 (20-40)	40 (30-70)	45 (35-80)	-	80 (50-100)	90 (55-110)	-	-	-	-	
	K3	PMXxx .6 .8 -EB45	0,10 -0,20	0,10 -0,25	0,30 -0,90	0,40 -1,20	0,50 -1,50	25 (15-30)	60 (40-100)	80 (30-150)	90 (35-170)	-	220 (120-300)	245 (135-335)	-	-	-	-	
	K4	PMXxx .6 .8 -EB45	0,10 -0,20	0,10 -0,25	0,30 -0,90	0,40 -1,20	0,50 -1,50	25 (15-30)	45 (30-70)	70 (40-120)	80 (45-135)	100 (70-150)	150 (80-200)	170 (90-225)	-	-	-	-	
	K5	PMXxx .6 .8 -EB45	0,10 -0,20	0,10 -0,25	0,30 -0,90	0,40 -1,20	0,50 -1,50	25 (15-30)	45 (30-70)	70 (40-120)	80 (45-135)	100 (70-150)	150 (80-200)	170 (90-225)	-	-	-	-	
	K6	PMXxx .6 .8 -EB45	0,10 -0,20	0,10 -0,25	0,30 -0,90	0,40 -1,20	0,50 -1,50	-	60 (40-100)	80 (30-150)	90 (35-170)	-	220 (120-300)	245 (135-335)	-	-	-	-	
	K7	PMXxx .6 .8 -EB45	0,10 -0,20	0,10 -0,25	0,30 -0,90	0,40 -1,20	0,50 -1,50	-	60 (40-100)	80 (30-150)	90 (35-170)	-	220 (120-300)	245 (135-335)	-	-	-	-	
	Barenatura	N1	PMXxx .6 .8 -EB45	0,10 -0,20	0,10 -0,30	0,30 -0,90	0,40 -1,20	0,50 -1,50	50 (30-100)	-	80 (30-150)	-	-	-	50 (30-100)	-	-	-	-
		N2	PMXxx .6 .8 -EB45	0,10 -0,20	0,10 -0,30	0,30 -0,90	0,40 -1,20	0,50 -1,50	50 (30-100)	-	80 (30-150)	-	-	-	50 (30-100)	-	-	-	-
		N3	PMXxx .6 .8 -EB45	0,10 -0,20	0,10 -0,30	0,30 -0,90	0,40 -1,20	0,50 -1,50	50 (30-100)	-	80 (30-150)	-	-	-	50 (30-100)	-	-	-	-
		N11	PMXxx .6 .8 -EB45	0,10 -0,20	0,10 -0,30	0,30 -0,90	0,40 -1,20	0,50 -1,50	50 (30-100)	-	80 (30-150)	-	-	-	50 (30-100)	-	-	-	-
S1		PMXxx .6 .8 -EB45	0,08 -0,15	0,10 -0,15	0,20 -0,60	0,30 -0,80	0,40 -1,00	-	20 (10-25)	20 (10-25)	-	-	-	-	-	-	-	25 (12-30)	
S2		PMXxx .6 .8 -EB45	0,08 -0,15	0,10 -0,15	0,20 -0,60	0,30 -0,80	0,40 -1,00	-	20 (10-25)	20 (10-25)	-	-	-	-	-	-	-	25 (12-30)	
Allegato	S3	PMXxx .6 .8 -EB45	0,08 -0,15	0,10 -0,15	0,20 -0,60	0,30 -0,80	0,40 -1,00	-	20 (10-25)	20 (10-25)	-	-	-	-	-	-	-	25 (12-30)	
	S11	PMXxx .6 .8 -EB45	0,08 -0,15	0,10 -0,15	0,20 -0,60	0,30 -0,80	0,40 -1,00	20 (15-30)	30 (15-40)	40 (20-50)	-	-	-	-	-	-	-	50 (25-65)	
	S12	PMXxx .6 .8 -EB45	0,08 -0,15	0,10 -0,15	0,20 -0,60	0,30 -0,80	0,40 -1,00	20 (15-30)	30 (15-40)	40 (20-50)	-	-	-	-	-	-	-	50 (25-65)	
	S13	PMXxx .6 .8 -EB45	0,08 -0,15	0,10 -0,15	0,20 -0,60	0,30 -0,80	0,40 -1,00	20 (15-30)	30 (15-40)	40 (20-50)	-	-	-	-	-	-	-	50 (25-65)	

La tabella continua alla pagina successiva.

Parametri di taglio – PM Plus... -EB45 misure metriche

SMG		a _p (°)		f			v _c										
		z=6	z=8 z=10	z=6	z=8	z=10	H15	CP20	RX2000	RK2050	CF	RX1500	RK1550	RN2010	RM2020	RM2090	RS2090
H3	PMXxx ..6 ..8 -EB45	0,08 -0,15	0,10 -0,15	0,20 -0,40	0,30 -0,60	0,40 -0,75	-	-	10 (8-15)	-	-	-	-	-	-	-	-
H5	PMXxx ..6 ..8 -EB45	0,08 -0,15	0,10 -0,15	0,20 -0,40	0,30 -0,60	0,40 -0,75	-	-	10 (8-15)	-	-	-	-	-	-	-	-
H7	PMXxx ..6 ..8 -EB45	0,08 -0,15	0,10 -0,15	0,20 -0,40	0,30 -0,60	0,40 -0,75	-	-	10 (8-15)	-	-	-	-	-	-	-	-
H8	PMXxx ..6 ..8 -EB45	0,08 -0,15	0,10 -0,15	0,20 -0,40	0,30 -0,60	0,40 -0,75	-	-	10 (8-15)	-	-	-	-	-	-	-	-
H11	PMXxx ..6 ..8 -EB45	0,08 -0,15	0,10 -0,15	0,20 -0,40	0,30 -0,60	0,40 -0,75	-	-	10 (8-15)	-	-	-	-	-	-	-	-
H12	PMXxx ..6 ..8 -EB45	0,08 -0,15	0,10 -0,15	0,20 -0,40	0,30 -0,60	0,40 -0,75	-	-	10 (8-15)	-	-	-	-	-	-	-	-
H21	PMXxx ..6 ..8 -EB45	0,08 -0,15	0,10 -0,15	0,20 -0,40	0,30 -0,60	0,40 -0,75	-	-	10 (8-15)	-	-	-	-	-	-	-	-
H31	PMXxx ..6 ..8 -EB45	0,08 -0,15	0,10 -0,15	0,20 -0,40	0,30 -0,60	0,40 -0,75	-	-	10 (8-15)	-	-	-	-	-	-	-	-
PM1	PMXxx ..6 ..8 -EB45	0,10 -0,20	0,10 -0,30	0,30 -0,90	0,40 -1,20	0,50 -1,50	-	50 (30-80)	70 (40-100)	-	-	-	-	-	-	-	-
PM2	PMXxx ..6 ..8 -EB45	0,10 -0,20	0,10 -0,30	0,30 -0,90	0,40 -1,20	0,50 -1,50	-	50 (30-80)	70 (40-100)	-	-	-	-	-	-	-	-
PM3	PMXxx ..6 ..8 -EB45	0,10 -0,20	0,10 -0,30	0,30 -0,90	0,40 -1,20	0,50 -1,50	-	50 (30-80)	70 (40-100)	-	-	-	-	-	-	-	-
TS1	PMXxx ..6 ..8 -EB45	0,10 -0,15	0,10 -0,20	0,30 -0,90	0,40 -1,20	0,50 -1,50	20 (15-25)	-	40 (20-60)	-	-	-	-	-	-	-	-
TS2	PMXxx ..6 ..8 -EB45	0,10 -0,15	0,10 -0,20	0,30 -0,90	0,40 -1,20	0,50 -1,50	20 (15-25)	-	40 (20-60)	-	-	-	-	-	-	-	-
TS3	PMXxx ..6 ..8 -EB45	0,10 -0,15	0,10 -0,20	0,30 -0,90	0,40 -1,20	0,50 -1,50	20 (15-25)	-	40 (20-60)	-	-	-	-	-	-	-	-
TS4	PMXxx ..6 ..8 -EB45	0,10 -0,15	0,10 -0,20	0,30 -0,90	0,40 -1,20	0,50 -1,50	20 (15-25)	-	40 (20-60)	-	-	-	-	-	-	-	-
TP1	PMXxx ..6 ..8 -EB45	0,10 -0,15	0,10 -0,20	0,30 -0,90	0,40 -1,20	0,50 -1,50	20 (15-25)	-	40 (20-60)	-	-	-	-	-	-	-	-
TP2	PMXxx ..6 ..8 -EB45	0,10 -0,15	0,10 -0,20	0,30 -0,90	0,40 -1,20	0,50 -1,50	20 (15-25)	-	40 (20-60)	-	-	-	-	-	-	-	-
TP3	PMXxx ..6 ..8 -EB45	0,10 -0,15	0,10 -0,20	0,30 -0,90	0,40 -1,20	0,50 -1,50	20 (15-25)	-	40 (20-60)	-	-	-	-	-	-	-	-
TP4	PMXxx ..6 ..8 -EB45	0,10 -0,15	0,10 -0,20	0,30 -0,90	0,40 -1,20	0,50 -1,50	20 (15-25)	-	40 (20-60)	-	-	-	-	-	-	-	-
GR1	PMXxx ..6 ..8 -EB45	0,10 -0,30	0,10 -0,40	0,30 -0,90	0,40 -1,20	0,50 -1,50	40 (80-20)	-	60 (30-120)	-	-	-	-	-	-	-	-

SMG = Gruppo materiale Seco

a_p = mm

f = mm/rev

v_c = m/min

Tutti i parametri di taglio sono valori di partenza

Parametri di taglio – PM Plus...-EB45 pollici

SMG		a_p (°)		f			v_c											
		z=6	z=8 z=10	z=6	z=8	z=10	H15	CP20	RX2000	RK2050	CF	RX1500	RK1550	RN2010	RM2020	RM2090	RS2090	
Introduzione	P1	PMXxx..6..8-EB45	.004 -.008	.004 -.012	.012 -.035	.016 -.047	.020 -.059	80 (50-100)	195 (100-330)	260 (100-490)	-	590 (295-655)	720 (395-985)	-	-	-	-	-
	P2	PMXxx..6..8-EB45	.004 -.008	.004 -.012	.012 -.035	.016 -.047	.020 -.059	80 (50-100)	195 (100-330)	260 (100-490)	-	590 (295-655)	720 (395-985)	-	-	-	-	-
	P3	PMXxx..6..8-EB45	.004 -.008	.004 -.012	.012 -.035	.016 -.047	.020 -.059	80 (50-100)	195 (100-330)	260 (100-490)	-	590 (295-655)	720 (395-985)	-	-	-	-	-
	P4	PMXxx..6..8-EB45	.004 -.008	.004 -.012	.008 -.028	.012 -.039	.016 -.047	65 (35-80)	165 (100-260)	195 (100-395)	-	395 (260-490)	590 (295-655)	-	-	-	-	-
	P5	PMXxx..6..8-EB45	.004 -.008	.004 -.012	.008 -.028	.012 -.039	.016 -.047	65 (35-80)	165 (100-260)	195 (100-395)	-	395 (260-490)	590 (295-655)	-	-	-	-	-
	P6	PMXxx..6..8-EB45	.004 -.008	.004 -.012	.008 -.028	.012 -.039	.016 -.047	65 (35-80)	165 (100-260)	195 (100-395)	-	395 (260-490)	590 (295-655)	-	-	-	-	-
	P7	PMXxx..6..8-EB45	.004 -.008	.004 -.012	.008 -.028	.012 -.039	.016 -.047	65 (35-80)	165 (100-260)	195 (100-395)	-	395 (260-490)	590 (295-655)	-	-	-	-	-
	P8	PMXxx..6..8-EB45	.004 -.008	.004 -.012	.008 -.028	.012 -.039	.016 -.047	50 (35-65)	115 (65-195)	130 (65-260)	-	260 (195-395)	395 (260-590)	-	-	-	-	-
Foratura	P11	PMXxx..6..8-EB45	.004 -.008	.004 -.012	.008 -.028	.012 -.039	.016 -.047	50 (35-65)	115 (65-195)	130 (65-260)	-	260 (195-395)	395 (260-590)	-	-	-	-	-
	P12	PMXxx..6..8-EB45	.004 -.008	.004 -.008	.008 -.028	.012 -.039	.016 -.047	40 (25-50)	80 (50-130)	100 (50-215)	-	215 (150-315)	315 (215-480)	-	-	-	-	-
	M1	PMXxx..6..8-EB45	.003 -.006	.004 -.008	.008 -.024	.012 -.031	.016 -.039	40 (30-50)	80 (50-130)	115 (65-230)	-	-	-	-	-	80 (50-130)	130 (80-260)	-
	M2	PMXxx..6..8-EB45	.003 -.006	.004 -.008	.008 -.024	.012 -.031	.016 -.039	-	80 (50-130)	115 (65-230)	-	-	-	-	-	80 (50-130)	130 (80-260)	-
	M3	PMXxx..6..8-EB45	.003 -.006	.004 -.008	.008 -.024	.012 -.031	.016 -.039	-	80 (50-130)	115 (65-230)	-	-	-	-	-	80 (50-130)	130 (80-260)	-
Alesatura	M4	PMXxx..6..8-EB45	.003 -.006	.004 -.008	.008 -.024	.012 -.031	.016 -.039	-	65 (35-100)	80 (50-165)	-	-	-	-	65 (35-100)	100 (65-195)	-	
	M5	PMXxx..6..8-EB45	.003 -.006	.004 -.008	.008 -.024	.012 -.031	.016 -.039	-	65 (35-100)	80 (50-165)	-	-	-	-	65 (35-100)	100 (65-195)	-	
	K1	PMXxx..6..8-EB45	.004 -.008	.004 -.010	.012 -.035	.016 -.047	.020 -.059	80 (50-100)	195 (130-330)	260 (100-490)	290 (110-550)	-	720 (395-985)	805 (440-1105)	-	-	-	-
	K2	PMXxx..6..8-EB45	.004 -.008	.004 -.010	.012 -.035	.016 -.047	.020 -.059	-	80 (65-130)	130 (100-230)	145 (110-260)	-	260 (165-330)	290 (185-370)	-	-	-	-
	K3	PMXxx..6..8-EB45	.004 -.008	.004 -.010	.012 -.035	.016 -.047	.020 -.059	80 (50-100)	195 (130-330)	260 (100-490)	290 (110-550)	-	720 (395-985)	805 (440-1105)	-	-	-	-
	K4	PMXxx..6..8-EB45	.004 -.008	.004 -.010	.012 -.035	.016 -.047	.020 -.059	80 (50-100)	150 (100-230)	230 (130-395)	260 (145-440)	330 (230-490)	490 (260-655)	550 (290-735)	-	-	-	-
	K5	PMXxx..6..8-EB45	.004 -.008	.004 -.010	.012 -.035	.016 -.047	.020 -.059	80 (50-100)	150 (100-230)	230 (130-395)	260 (145-440)	330 (230-490)	490 (260-655)	550 (290-735)	-	-	-	-
	K6	PMXxx..6..8-EB45	.004 -.008	.004 -.010	.012 -.035	.016 -.047	.020 -.059	-	195 (130-330)	260 (100-490)	290 (110-550)	-	720 (395-985)	805 (440-1105)	-	-	-	-
K7	PMXxx..6..8-EB45	.004 -.008	.004 -.010	.012 -.035	.016 -.047	.020 -.059	-	195 (130-330)	260 (100-490)	290 (110-550)	-	720 (395-985)	805 (440-1105)	-	-	-	-	
Barenatura	N1	PMXxx..6..8-EB45	.004 -.008	.004 -.012	.012 -.035	.016 -.047	.020 -.059	165 (100-330)	-	260 (100-490)	-	-	-	165 (100-330)	-	-	-	
	N2	PMXxx..6..8-EB45	.004 -.008	.004 -.012	.012 -.035	.016 -.047	.020 -.059	165 (100-330)	-	260 (100-490)	-	-	-	165 (100-330)	-	-	-	
	N3	PMXxx..6..8-EB45	.004 -.008	.004 -.012	.012 -.035	.016 -.047	.020 -.059	165 (100-330)	-	260 (100-490)	-	-	-	165 (100-330)	-	-	-	
	N11	PMXxx..6..8-EB45	.004 -.008	.004 -.012	.012 -.035	.016 -.047	.020 -.059	165 (100-330)	-	260 (100-490)	-	-	-	165 (100-330)	-	-	-	
	S1	PMXxx..6..8-EB45	.003 -.006	.004 -.006	.008 -.024	.012 -.031	.016 -.039	-	65 (35-80)	65 (35-80)	-	-	-	-	-	-	80 (40-100)	
	S2	PMXxx..6..8-EB45	.003 -.006	.004 -.006	.008 -.024	.012 -.031	.016 -.039	-	65 (35-80)	65 (35-80)	-	-	-	-	-	-	80 (40-100)	
	S3	PMXxx..6..8-EB45	.003 -.006	.004 -.006	.008 -.024	.012 -.031	.016 -.039	-	65 (35-80)	65 (35-80)	-	-	-	-	-	-	80 (40-100)	
Allegato	S11	PMXxx..6..8-EB45	.003 -.006	.004 -.006	.008 -.024	.012 -.031	.016 -.039	65 (50-100)	100 (50-130)	130 (65-165)	-	-	-	-	-	-	165 (80-215)	
	S12	PMXxx..6..8-EB45	.003 -.006	.004 -.006	.008 -.024	.012 -.031	.016 -.039	65 (50-100)	100 (50-130)	130 (65-165)	-	-	-	-	-	-	165 (80-215)	
	S13	PMXxx..6..8-EB45	.003 -.006	.004 -.006	.008 -.024	.012 -.031	.016 -.039	65 (50-100)	100 (50-130)	130 (65-165)	-	-	-	-	-	-	165 (80-215)	

La tabella continua alla pagina successiva.

Parametri di taglio – PM Plus...-EB45 pollici

SMG		a _p (°)		f			v _c										
		z=6	z=8 z=10	z=6	z=8	z=10	H15	CP20	RX2000	RK2050	CF	RX1500	RK1550	RN2010	RM2020	RM2090	RS2090
H5	PMXxx .6 .8 -EB45	.003 -.006	.004 -.006	.008 -.016	.012 -.024	.016 -.030	-	-	35 (25-50)	-	-	-	-	-	-	-	-
H7	PMXxx .6 .8 -EB45	.003 -.006	.004 -.006	.008 -.016	.012 -.024	.016 -.030	-	-	35 (25-50)	-	-	-	-	-	-	-	-
H8	PMXxx .6 .8 -EB45	.003 -.006	.004 -.006	.008 -.016	.012 -.024	.016 -.030	-	-	35 (25-50)	-	-	-	-	-	-	-	-
H11	PMXxx .6 .8 -EB45	.003 -.006	.004 -.006	.008 -.016	.012 -.024	.016 -.030	-	-	35 (25-50)	-	-	-	-	-	-	-	-
H12	PMXxx .6 .8 -EB45	.003 -.006	.004 -.006	.008 -.016	.012 -.024	.016 -.030	-	-	35 (25-50)	-	-	-	-	-	-	-	-
H21	PMXxx .6 .8 -EB45	.003 -.006	.004 -.006	.008 -.016	.012 -.024	.016 -.030	-	-	35 (25-50)	-	-	-	-	-	-	-	-
H31	PMXxx .6 .8 -EB45	.003 -.006	.004 -.006	.008 -.016	.012 -.024	.016 -.030	-	-	35 (25-50)	-	-	-	-	-	-	-	-
PM1	PMXxx .6 .8 -EB45	.004 -.008	.004 -.012	.012 -.035	.016 -.047	.020 -.059	-	165 (100-260)	230 (130-330)	-	-	-	-	-	-	-	-
PM2	PMXxx .6 .8 -EB45	.004 -.008	.004 -.012	.012 -.035	.016 -.047	.020 -.059	-	165 (100-260)	230 (130-330)	-	-	-	-	-	-	-	-
PM3	PMXxx .6 .8 -EB45	.004 -.008	.004 -.012	.012 -.035	.016 -.047	.020 -.059	-	165 (100-260)	230 (130-330)	-	-	-	-	-	-	-	-
TS1	PMXxx .6 .8 -EB45	.004 -.006	.004 -.008	.012 -.035	.016 -.047	.020 -.059	65 (50-80)	-	130 (65-195)	-	-	-	-	-	-	-	-
TS2	PMXxx .6 .8 -EB45	.004 -.006	.004 -.008	.012 -.035	.016 -.047	.020 -.059	65 (50-80)	-	130 (65-195)	-	-	-	-	-	-	-	-
TS3	PMXxx .6 .8 -EB45	.004 -.006	.004 -.008	.012 -.035	.016 -.047	.020 -.059	65 (50-80)	-	130 (65-195)	-	-	-	-	-	-	-	-
TS4	PMXxx .6 .8 -EB45	.004 -.006	.004 -.008	.012 -.035	.016 -.047	.020 -.059	65 (50-80)	-	130 (65-195)	-	-	-	-	-	-	-	-
TP1	PMXxx .6 .8 -EB45	.004 -.006	.004 -.008	.012 -.035	.016 -.047	.020 -.059	65 (50-80)	-	130 (65-195)	-	-	-	-	-	-	-	-
TP2	PMXxx .6 .8 -EB45	.004 -.006	.004 -.008	.012 -.035	.016 -.047	.020 -.059	65 (50-80)	-	130 (65-195)	-	-	-	-	-	-	-	-
TP3	PMXxx .6 .8 -EB45	.004 -.006	.004 -.008	.012 -.035	.016 -.047	.020 -.059	65 (50-80)	-	130 (65-195)	-	-	-	-	-	-	-	-
TP4	PMXxx .6 .8 -EB45	.004 -.006	.004 -.008	.012 -.035	.016 -.047	.020 -.059	65 (50-80)	-	130 (65-195)	-	-	-	-	-	-	-	-
GR1	PMXxx .6 .8 -EB45	.004 -.012	.004 -.016	.012 -.035	.016 -.047	.020 -.059	65 (260-65)	-	130 (100-395)	-	-	-	-	-	-	-	-

SMG = Gruppo materiale Seco

a_p = inch

f = in/rev

v_c = sf/min

Tutti i parametri di taglio sono valori di partenza

Introduzione

Foratura

Alesatura

Barenatura

Allegato

Parametri di taglio – PM Plus...-EB845 misure metriche

SMG		a _p (°)		f			v _c										
		z=6	z=8 z=10	z=6	z=8	z=10	H15	CP20	RX2000	RK2050	CF	RX1500	RK1550	RM2020	RM2090	RS2090	
Introduzione	P3	PMXxx .6 .8 -EB845	0,10 -0,20	0,10 -0,30	0,30 -0,90	0,40 -1,20	0,50 -1,50	25 (15-30)	60 (30-100)	80 (30-150)	-	180 (90-200)	220 (120-300)	-	-	-	-
	P4	PMXxx .6 .8 -EB845	0,10 -0,20	0,10 -0,30	0,20 -0,70	0,30 -1,00	0,40 -1,20	20 (10-25)	50 (30-80)	60 (30-120)	-	120 (80-150)	180 (90-200)	-	-	-	-
	P5	PMXxx .6 .8 -EB845	0,10 -0,20	0,10 -0,30	0,20 -0,70	0,30 -1,00	0,40 -1,20	20 (10-25)	50 (30-80)	60 (30-120)	-	120 (80-150)	180 (90-200)	-	-	-	-
	P6	PMXxx .6 .8 -EB845	0,10 -0,20	0,10 -0,30	0,20 -0,70	0,30 -1,00	0,40 -1,20	20 (10-25)	50 (30-80)	60 (30-120)	-	120 (80-150)	180 (90-200)	-	-	-	-
	P7	PMXxx .6 .8 -EB845	0,10 -0,20	0,10 -0,30	0,20 -0,70	0,30 -1,00	0,40 -1,20	20 (10-25)	50 (30-80)	60 (30-120)	-	120 (80-150)	180 (90-200)	-	-	-	-
	P8	PMXxx .6 .8 -EB845	0,10 -0,20	0,10 -0,30	0,20 -0,70	0,30 -1,00	0,40 -1,20	15 (10-20)	35 (20-60)	40 (20-80)	-	80 (60-120)	120 (80-180)	-	-	-	-
	P11	PMXxx .6 .8 -EB845	0,10 -0,20	0,10 -0,30	0,20 -0,70	0,30 -1,00	0,40 -1,20	15 (10-20)	35 (20-60)	40 (20-80)	-	80 (60-120)	120 (80-180)	-	-	-	-
	P12	PMXxx .6 .8 -EB845	0,10 -0,20	0,10 -0,30	0,20 -0,70	0,30 -1,00	0,40 -1,20	12 (8-15)	25 (15-45)	30 (15-65)	-	65 (45-95)	95 (65-145)	-	-	-	-
Foratura	M1	PMXxx .6 .8 -EB845	0,08 -0,15	0,10 -0,20	0,20 -0,60	0,30 -0,80	0,40 -1,00	12 (9-15)	25 (15-45)	35 (20-70)	-	-	-	-	25 (15-40)	35 (20-70)	-
	M2	PMXxx .6 .8 -EB845	0,08 -0,15	0,10 -0,20	0,20 -0,60	0,30 -0,80	0,40 -1,00	-	25 (15-45)	35 (20-70)	-	-	-	-	25 (15-40)	35 (20-70)	-
	M3	PMXxx .6 .8 -EB845	0,08 -0,15	0,10 -0,20	0,20 -0,60	0,30 -0,80	0,40 -1,00	-	25 (15-45)	35 (20-70)	-	-	-	-	25 (15-40)	35 (20-70)	-
	M4	PMXxx .6 .8 -EB845	0,08 -0,15	0,10 -0,20	0,20 -0,60	0,30 -0,80	0,40 -1,00	-	20 (10-30)	25 (15-50)	-	-	-	-	20 (10-30)	25 (15-50)	-
	M5	PMXxx .6 .8 -EB845	0,08 -0,15	0,10 -0,20	0,20 -0,60	0,30 -0,80	0,40 -1,00	-	20 (10-30)	25 (15-50)	-	-	-	-	20 (10-30)	25 (15-50)	-
Alesatura	K1	PMXxx .6 .8 -EB845	0,10 -0,20	0,10 -0,25	0,30 -0,90	0,40 -1,20	0,50 -1,50	25 (15-30)	60 (40-100)	80 (30-150)	90 (35-170)	-	220 (120-300)	245 (135-335)	-	-	-
	K2	PMXxx .6 .8 -EB845	0,10 -0,20	0,10 -0,25	0,30 -0,90	0,40 -1,20	0,50 -1,50	-	25 (20-40)	40 (30-70)	45 (35-80)	-	80 (50-100)	90 (55-110)	-	-	-
	K3	PMXxx .6 .8 -EB845	0,10 -0,20	0,10 -0,25	0,30 -0,90	0,40 -1,20	0,50 -1,50	25 (15-30)	60 (40-100)	80 (30-150)	90 (35-170)	-	220 (120-300)	245 (135-335)	-	-	-
	K4	PMXxx .6 .8 -EB845	0,10 -0,20	0,10 -0,25	0,30 -0,90	0,40 -1,20	0,50 -1,50	25 (15-30)	45 (30-70)	70 (40-120)	80 (45-135)	100 (70-150)	150 (80-200)	170 (90-225)	-	-	-
	K5	PMXxx .6 .8 -EB845	0,10 -0,20	0,10 -0,25	0,30 -0,90	0,40 -1,20	0,50 -1,50	25 (15-30)	45 (30-70)	70 (40-120)	80 (45-135)	100 (70-150)	150 (80-200)	170 (90-225)	-	-	-
	K6	PMXxx .6 .8 -EB845	0,10 -0,20	0,10 -0,25	0,30 -0,90	0,40 -1,20	0,50 -1,50	-	60 (40-100)	80 (30-150)	90 (35-170)	-	220 (120-300)	245 (135-335)	-	-	-
	K7	PMXxx .6 .8 -EB845	0,10 -0,20	0,10 -0,25	0,30 -0,90	0,40 -1,20	0,50 -1,50	-	60 (40-100)	80 (30-150)	90 (35-170)	-	220 (120-300)	245 (135-335)	-	-	-
	S1	PMXxx .6 .8 -EB845	0,08 -0,15	0,10 -0,15	0,20 -0,60	0,30 -0,80	0,40 -1,00	-	20 (10-25)	20 (10-25)	-	-	-	-	-	-	25 (12-30)
	S2	PMXxx .6 .8 -EB845	0,08 -0,15	0,10 -0,15	0,20 -0,60	0,30 -0,80	0,40 -1,00	-	20 (10-25)	20 (10-25)	-	-	-	-	-	-	25 (12-30)
	S3	PMXxx .6 .8 -EB845	0,08 -0,15	0,10 -0,15	0,20 -0,60	0,30 -0,80	0,40 -1,00	-	20 (10-25)	20 (10-25)	-	-	-	-	-	-	25 (12-30)
	S11	PMXxx .6 .8 -EB845	0,08 -0,15	0,10 -0,15	0,20 -0,60	0,30 -0,80	0,40 -1,00	20 (15-30)	30 (15-40)	40 (20-50)	-	-	-	-	-	-	50 (25-65)
	S12	PMXxx .6 .8 -EB845	0,08 -0,15	0,10 -0,15	0,20 -0,60	0,30 -0,80	0,40 -1,00	20 (15-30)	30 (15-40)	40 (20-50)	-	-	-	-	-	-	50 (25-65)
	S13	PMXxx .6 .8 -EB845	0,08 -0,15	0,10 -0,15	0,20 -0,60	0,30 -0,80	0,40 -1,00	20 (15-30)	30 (15-40)	40 (20-50)	-	-	-	-	-	-	50 (25-65)
Barenatura	H3	PMXxx .6 .8 -EB845	0,08 -0,15	0,10 -0,15	0,20 -0,40	0,30 -0,60	0,40 -0,75	-	-	10 (8-15)	-	-	-	-	-	-	-
	H5	PMXxx .6 .8 -EB845	0,08 -0,15	0,10 -0,15	0,20 -0,40	0,30 -0,60	0,40 -0,75	-	-	10 (8-15)	-	-	-	-	-	-	-
	H7	PMXxx .6 .8 -EB845	0,08 -0,15	0,10 -0,15	0,20 -0,40	0,30 -0,60	0,40 -0,75	-	-	10 (8-15)	-	-	-	-	-	-	-
	H8	PMXxx .6 .8 -EB845	0,08 -0,15	0,10 -0,15	0,20 -0,40	0,30 -0,60	0,40 -0,75	-	-	10 (8-15)	-	-	-	-	-	-	-
	H11	PMXxx .6 .8 -EB845	0,08 -0,15	0,10 -0,15	0,20 -0,40	0,30 -0,60	0,40 -0,75	-	-	10 (8-15)	-	-	-	-	-	-	-
	H12	PMXxx .6 .8 -EB845	0,08 -0,15	0,10 -0,15	0,20 -0,40	0,30 -0,60	0,40 -0,75	-	-	10 (8-15)	-	-	-	-	-	-	-
	H21	PMXxx .6 .8 -EB845	0,08 -0,15	0,10 -0,15	0,20 -0,40	0,30 -0,60	0,40 -0,75	-	-	10 (8-15)	-	-	-	-	-	-	-
Allegato	H31	PMXxx .6 .8 -EB845	0,08 -0,15	0,10 -0,15	0,20 -0,40	0,30 -0,60	0,40 -0,75	-	-	10 (8-15)	-	-	-	-	-	-	-
	PM1	PMXxx .6 .8 -EB845	0,10 -0,20	0,10 -0,30	0,30 -0,90	0,40 -1,20	0,50 -1,50	-	50 (30-80)	70 (40-100)	-	-	-	-	-	-	-
	PM2	PMXxx .6 .8 -EB845	0,10 -0,20	0,10 -0,30	0,30 -0,90	0,40 -1,20	0,50 -1,50	-	50 (30-80)	70 (40-100)	-	-	-	-	-	-	-
	PM3	PMXxx .6 .8 -EB845	0,10 -0,20	0,10 -0,30	0,30 -0,90	0,40 -1,20	0,50 -1,50	-	50 (30-80)	70 (40-100)	-	-	-	-	-	-	-

SMG = Gruppo materiale Seco
 a_p = mm
 f = mm/rev
 v_c = m/min
 Tutti i parametri di taglio sono valori di partenza

Parametri di taglio – PM Plus...-EB845 pollici

SMG		a _p (°)		f			v _c									
		z=6	z=8 z=10	z=6	z=8	z=10	H15	CP20	RX2000	RK2050	CF	RX1500	RK1550	RM2020	RM2090	RS2090
P3	PMxxx..6..8-EB45	.004 -.008	.004 -.012	.012 -.035	.016 -.047	.020 -.059	80 (50-100)	195 (100-330)	260 (100-490)	-	590 (295-655)	720 (395-985)	-	-	-	-
P4	PMxxx..6..8-EB45	.004 -.008	.004 -.012	.008 -.028	.012 -.039	.016 -.047	65 (35-80)	165 (100-260)	195 (100-395)	-	395 (260-490)	590 (295-655)	-	-	-	-
P5	PMxxx..6..8-EB45	.004 -.008	.004 -.012	.008 -.028	.012 -.039	.016 -.047	65 (35-80)	165 (100-260)	195 (100-395)	-	395 (260-490)	590 (295-655)	-	-	-	-
P6	PMxxx..6..8-EB45	.004 -.008	.004 -.012	.008 -.028	.012 -.039	.016 -.047	65 (35-80)	165 (100-260)	195 (100-395)	-	395 (260-490)	590 (295-655)	-	-	-	-
P7	PMxxx..6..8-EB45	.004 -.008	.004 -.012	.008 -.028	.012 -.039	.016 -.047	65 (35-80)	165 (100-260)	195 (100-395)	-	395 (260-490)	590 (295-655)	-	-	-	-
P8	PMxxx..6..8-EB45	.004 -.008	.004 -.012	.008 -.028	.012 -.039	.016 -.047	50 (35-65)	115 (65-195)	130 (65-260)	-	260 (195-395)	395 (260-590)	-	-	-	-
P11	PMxxx..6..8-EB45	.004 -.008	.004 -.012	.008 -.028	.012 -.039	.016 -.047	50 (35-65)	115 (65-195)	130 (65-260)	-	260 (195-395)	395 (260-590)	-	-	-	-
P12	PMxxx..6..8-EB45	.004 -.008	.004 -.012	.008 -.028	.012 -.039	.016 -.047	40 (25-50)	80 (50-130)	100 (50-215)	-	215 (150-315)	315 (215-480)	-	-	-	-
M1	PMxxx..6..8-EB45	.003 -.006	.004 -.008	.008 -.024	.012 -.031	.016 -.039	40 (30-50)	80 (50-130)	115 (65-230)	-	-	-	-	80 (50-130)	115 (65-230)	-
M2	PMxxx..6..8-EB45	.003 -.006	.004 -.008	.008 -.024	.012 -.031	.016 -.039	-	80 (50-130)	115 (65-230)	-	-	-	-	80 (50-130)	115 (65-230)	-
M3	PMxxx..6..8-EB45	.003 -.006	.004 -.008	.008 -.024	.012 -.031	.016 -.039	-	80 (50-130)	115 (65-230)	-	-	-	-	80 (50-130)	115 (65-230)	-
M4	PMxxx..6..8-EB45	.003 -.006	.004 -.008	.008 -.024	.012 -.031	.016 -.039	-	65 (35-100)	80 (50-165)	-	-	-	-	65 (35-100)	80 (50-165)	-
M5	PMxxx..6..8-EB45	.003 -.006	.004 -.008	.008 -.024	.012 -.031	.016 -.039	-	65 (35-100)	80 (50-165)	-	-	-	-	65 (35-100)	80 (50-165)	-
K1	PMxxx..6..8-EB45	.004 -.008	.004 -.010	.012 -.035	.016 -.047	.020 -.059	80 (50-100)	195 (130-330)	260 (100-490)	290 (110-550)	-	720 (395-985)	805 (440-1105)	-	-	-
K2	PMxxx..6..8-EB45	.004 -.008	.004 -.010	.012 -.035	.016 -.047	.020 -.059	-	80 (65-130)	130 (100-230)	145 (100-230)	-	260 (165-330)	290 (185-370)	-	-	-
K3	PMxxx..6..8-EB45	.004 -.008	.004 -.010	.012 -.035	.016 -.047	.020 -.059	80 (50-100)	195 (130-330)	260 (100-490)	290 (110-550)	-	720 (395-985)	805 (440-1105)	-	-	-
K4	PMxxx..6..8-EB45	.004 -.008	.004 -.010	.012 -.035	.016 -.047	.020 -.059	80 (50-100)	150 (100-230)	230 (130-395)	260 (145-440)	330 (230-490)	490 (260-655)	550 (290-735)	-	-	-
K5	PMxxx..6..8-EB45	.004 -.008	.004 -.010	.012 -.035	.016 -.047	.020 -.059	80 (50-100)	150 (100-230)	230 (130-395)	260 (145-440)	330 (230-490)	490 (260-655)	550 (290-735)	-	-	-
K6	PMxxx..6..8-EB45	.004 -.008	.004 -.010	.012 -.035	.016 -.047	.020 -.059	-	195 (130-330)	260 (100-490)	290 (110-550)	-	720 (395-985)	805 (440-1105)	-	-	-
K7	PMxxx..6..8-EB45	.004 -.008	.004 -.010	.012 -.035	.016 -.047	.020 -.059	-	195 (130-330)	260 (100-490)	290 (110-550)	-	720 (395-985)	805 (440-1105)	-	-	-
S1	PMxxx..6..8-EB45	.003 -.006	.004 -.006	.008 -.024	.012 -.031	.016 -.039	-	65 (35-80)	65 (35-80)	-	-	-	-	-	80 (40-100)	-
S2	PMxxx..6..8-EB45	.003 -.006	.004 -.006	.008 -.024	.012 -.031	.016 -.039	-	65 (35-80)	65 (35-80)	-	-	-	-	-	80 (40-100)	-
S3	PMxxx..6..8-EB45	.003 -.006	.004 -.006	.008 -.024	.012 -.031	.016 -.039	-	65 (35-80)	65 (35-80)	-	-	-	-	-	80 (40-100)	-
S11	PMxxx..6..8-EB45	.003 -.006	.004 -.006	.008 -.024	.012 -.031	.016 -.039	65 (50-100)	100 (50-130)	130 (65-165)	-	-	-	-	-	165 (80-215)	-
S12	PMxxx..6..8-EB45	.003 -.006	.004 -.006	.008 -.024	.012 -.031	.016 -.039	65 (50-100)	100 (50-130)	130 (65-165)	-	-	-	-	-	165 (80-215)	-
S13	PMxxx..6..8-EB45	.003 -.006	.004 -.006	.008 -.024	.012 -.031	.016 -.039	65 (50-100)	100 (50-130)	130 (65-165)	-	-	-	-	-	165 (80-215)	-
H3	PMxxx..6..8-EB45	.003 -.006	.004 -.006	.008 -.016	.012 -.024	.016 -.030	-	-	35 (25-50)	-	-	-	-	-	-	-
H5	PMxxx..6..8-EB45	.003 -.006	.004 -.006	.008 -.016	.012 -.024	.016 -.030	-	-	35 (25-50)	-	-	-	-	-	-	-
H7	PMxxx..6..8-EB45	.003 -.006	.004 -.006	.008 -.016	.012 -.024	.016 -.030	-	-	35 (25-50)	-	-	-	-	-	-	-
H8	PMxxx..6..8-EB45	.003 -.006	.004 -.006	.008 -.016	.012 -.024	.016 -.030	-	-	35 (25-50)	-	-	-	-	-	-	-
H11	PMxxx..6..8-EB45	.003 -.006	.004 -.006	.008 -.016	.012 -.024	.016 -.030	-	-	35 (25-50)	-	-	-	-	-	-	-
H12	PMxxx..6..8-EB45	.003 -.006	.004 -.006	.008 -.016	.012 -.024	.016 -.030	-	-	35 (25-50)	-	-	-	-	-	-	-
H21	PMxxx..6..8-EB45	.003 -.006	.004 -.006	.008 -.016	.012 -.024	.016 -.030	-	-	35 (25-50)	-	-	-	-	-	-	-
H31	PMxxx..6..8-EB45	.003 -.006	.004 -.006	.008 -.016	.012 -.024	.016 -.030	-	-	35 (25-50)	-	-	-	-	-	-	-
PM1	PMxxx..6..8-EB45	.004 -.008	.004 -.012	.012 -.035	.016 -.047	.020 -.059	-	165 (100-260)	230 (130-330)	-	-	-	-	-	-	-
PM2	PMxxx..6..8-EB45	.004 -.008	.004 -.012	.012 -.035	.016 -.047	.020 -.059	-	165 (100-260)	230 (130-330)	-	-	-	-	-	-	-
PM3	PMxxx..6..8-EB45	.004 -.008	.004 -.012	.012 -.035	.016 -.047	.020 -.059	-	165 (100-260)	230 (130-330)	-	-	-	-	-	-	-

SMG = Gruppo materiale Seco

a_p = inch

f = in/rev

v_c = sf/min

Tutti i parametri di taglio sono valori di partenza

Introduzione

Foratura

Alesatura

Barenatura

Allegato

Parametri di taglio – Plus... -EB25/EB30 misure metriche

SMG		a_p (°)		f			v_c						
		Z=6	Z=8 Z=10	Z=6	Z=8	Z=10	H15	CP20	RX2000	RK2050	CF	RX1500	RK1550
P1	PMXxx .6 .8 -EB25/EB30	0,10-0,20	0,10-0,30	0,80-1,80	1,00-2,40	1,20-3,00	25 (15-30)	60 (30-100)	80 (30-150)	–	180 (90-200)	220 (120-300)	–
P2	PMXxx .6 .8 -EB25/EB30	0,10-0,20	0,10-0,30	0,80-1,80	1,00-2,40	1,20-3,00	25 (15-30)	60 (30-100)	80 (30-150)	–	180 (90-200)	220 (120-300)	–
P3	PMXxx .6 .8 -EB25/EB30	0,10-0,20	0,10-0,30	0,80-1,80	1,00-2,40	1,20-3,00	25 (15-30)	60 (30-100)	80 (30-150)	–	180 (90-200)	220 (120-300)	–
P4	PMXxx .6 .8 -EB25/EB30	0,10-0,20	0,10-0,30	0,80-1,80	1,00-2,40	1,20-3,00	20 (10-25)	50 (30-80)	60 (30-120)	–	120 (80-150)	180 (90-200)	–
P5	PMXxx .6 .8 -EB25/EB30	0,10-0,20	0,10-0,30	0,80-1,80	1,00-2,40	1,20-3,00	20 (10-25)	50 (30-80)	60 (30-120)	–	120 (80-150)	180 (90-200)	–
P6	PMXxx .6 .8 -EB25/EB30	0,10-0,20	0,10-0,30	0,80-1,80	1,00-2,40	1,20-3,00	20 (10-25)	50 (30-80)	60 (30-120)	–	120 (80-150)	180 (90-200)	–
P7	PMXxx .6 .8 -EB25/EB30	0,10-0,20	0,10-0,30	0,80-1,80	1,00-2,40	1,20-3,00	20 (10-25)	50 (30-80)	60 (30-120)	–	120 (80-150)	180 (90-200)	–
M1	PMXxx .6 .8 -EB25/EB30	0,08-0,15	0,10-0,20	0,80-1,20	1,00-2,00	1,20-2,50	–	25 (15-40)	35 (20-70)	–	–	–	–
K1	PMXxx .6 .8 -EB25/EB30	0,10-0,20	0,10-0,25	0,80-2,20	1,00-2,80	1,20-3,50	25 (15-30)	60 (40-100)	80 (30-150)	90 (35-170)	–	220 (120-300)	245 (135-335)
K2	PMXxx .6 .8 -EB25/EB30	0,10-0,20	0,10-0,25	0,80-1,80	1,00-2,40	1,20-3,00	–	25 (20-40)	40 (30-70)	45 (35-80)	–	80 (50-100)	90 (55-110)
K3	PMXxx .6 .8 -EB25/EB30	0,10-0,20	0,10-0,25	0,80-2,20	1,00-2,80	1,20-3,50	25 (15-30)	60 (40-100)	80 (30-150)	90 (35-170)	–	220 (120-300)	245 (135-335)
K4	PMXxx .6 .8 -EB25/EB30	0,10-0,20	0,10-0,25	0,80-2,20	1,00-2,80	1,20-3,50	25 (15-30)	45 (30-70)	70 (40-120)	80 (45-135)	100 (70-150)	150 (80-200)	170 (90-225)
K5	PMXxx .6 .8 -EB25/EB30	0,10-0,20	0,10-0,25	0,80-2,20	1,00-2,80	1,20-3,50	25 (15-30)	45 (30-70)	70 (40-120)	80 (45-135)	100 (70-150)	150 (80-200)	170 (90-225)
K6	PMXxx .6 .8 -EB25/EB30	0,10-0,20	0,10-0,25	0,80-1,80	1,00-2,40	1,20-3,00	–	60 (40-100)	80 (30-150)	90 (35-170)	–	220 (120-300)	245 (135-335)
K7	PMXxx .6 .8 -EB25/EB30	0,10-0,20	0,10-0,25	0,80-1,80	1,00-2,40	1,20-3,00	–	60 (40-100)	80 (30-150)	90 (35-170)	–	220 (120-300)	245 (135-335)
N1	PMXxx .6 .8 -EB25/EB30	0,10-0,20	0,10-0,30	0,80-2,20	1,00-2,80	1,20-3,50	50 (30-100)	–	–	–	–	–	–
N2	PMXxx .6 .8 -EB25/EB30	0,10-0,20	0,10-0,30	0,80-2,20	1,00-2,80	1,20-3,50	50 (30-100)	–	–	–	–	–	–
N3	PMXxx .6 .8 -EB25/EB30	0,10-0,20	0,10-0,30	0,80-2,20	1,00-2,80	1,20-3,50	50 (30-100)	–	–	–	–	–	–
N11	PMXxx .6 .8 -EB25/EB30	0,10-0,20	0,10-0,30	0,80-2,20	1,00-2,80	1,20-3,50	50 (30-100)	–	–	–	–	–	–
PM1	PMXxx .6 .8 -EB25/EB30	0,10-0,20	0,10-0,30	0,50-1,80	0,80-2,00	1,00-2,50	–	50 (30-80)	70 (40-100)	–	–	–	–
PM2	PMXxx .6 .8 -EB25/EB30	0,10-0,20	0,10-0,30	0,50-1,80	0,80-2,00	1,00-2,50	–	50 (30-80)	70 (40-100)	–	–	–	–
PM3	PMXxx .6 .8 -EB25/EB30	0,10-0,20	0,10-0,30	0,50-1,80	0,80-2,00	1,00-2,50	–	50 (30-80)	70 (40-100)	–	–	–	–

SMG = Gruppo materiale Seco

a_p = mm

f = mm/rev

v_c = m/min

Tutti i parametri di taglio sono valori di partenza

Parametri di taglio – PM Plus... -EB25/EB30 pollici

SMG		a_p (°)		f			v_c						
		z=6	z=8 z=10	z=6	z=8	z=10	H15	CP20	RX2000	RK2050	CF	RX1500	RK1550
P1	PMXxx .6 .8 -EB25/EB30	.004-.008	.004-.012	.031-.071	.039-.094	.047-.118	80 (50-100)	195 (100-330)	260 (100-490)	-	590 (295-655)	720 (395-985)	-
P2	PMXxx .6 .8 -EB25/EB30	.004-.008	.004-.012	.031-.071	.039-.094	.047-.118	80 (50-100)	195 (100-330)	260 (100-490)	-	590 (295-655)	720 (395-985)	-
P3	PMXxx .6 .8 -EB25/EB30	.004-.008	.004-.012	.031-.071	.039-.094	.047-.118	80 (50-100)	195 (100-330)	260 (100-490)	-	590 (295-655)	720 (395-985)	-
P4	PMXxx .6 .8 -EB25/EB30	.004-.008	.004-.012	.031-.071	.039-.094	.047-.118	65 (35-80)	165 (100-260)	195 (100-395)	-	395 (260-490)	590 (295-655)	-
P5	PMXxx .6 .8 -EB25/EB30	.004-.008	.004-.012	.031-.071	.039-.094	.047-.118	65 (35-80)	165 (100-260)	195 (100-395)	-	395 (260-490)	590 (295-655)	-
P6	PMXxx .6 .8 -EB25/EB30	.004-.008	.004-.012	.031-.071	.039-.094	.047-.118	65 (35-80)	165 (100-260)	195 (100-395)	-	395 (260-490)	590 (295-655)	-
P7	PMXxx .6 .8 -EB25/EB30	.004-.008	.004-.012	.031-.071	.039-.094	.047-.118	65 (35-80)	165 (100-260)	195 (100-395)	-	395 (260-490)	590 (295-655)	-
M1	PMXxx .6 .8 -EB25/EB30	.003-.006	.004-.008	.031-.047	.039-.079	.039-.098	-	80 (50-130)	115 (65-230)	-	-	-	-
K1	PMXxx .6 .8 -EB25/EB30	.004-.008	.004-.010	.031-.087	.039-.110	.047-.138	80 (50-100)	195 (130-330)	260 (100-490)	290 (110-550)	-	720 (395-985)	805 (440-1105)
K2	PMXxx .6 .8 -EB25/EB30	.004-.008	.004-.010	.031-.071	.039-.094	.047-.118	-	80 (65-130)	130 (100-230)	145 (110-260)	-	260 (165-330)	290 (185-370)
K3	PMXxx .6 .8 -EB25/EB30	.004-.008	.004-.010	.031-.087	.039-.110	.047-.138	80 (50-100)	195 (130-330)	260 (100-490)	290 (110-550)	-	720 (395-985)	805 (440-1105)
K4	PMXxx .6 .8 -EB25/EB30	.004-.008	.004-.010	.031-.087	.039-.110	.047-.138	80 (50-100)	150 (100-230)	230 (130-395)	260 (145-440)	330 (230-490)	490 (260-655)	550 (290-735)
K5	PMXxx .6 .8 -EB25/EB30	.004-.008	.004-.010	.031-.087	.039-.110	.047-.138	80 (50-100)	150 (100-230)	230 (130-395)	260 (145-440)	330 (230-490)	490 (260-655)	550 (290-735)
K6	PMXxx .6 .8 -EB25/EB30	.004-.008	.004-.010	.031-.071	.039-.094	.047-.118	-	195 (130-330)	260 (100-490)	290 (110-550)	-	720 (395-985)	805 (440-1105)
K7	PMXxx .6 .8 -EB25/EB30	.004-.008	.004-.010	.031-.071	.039-.094	.047-.118	-	195 (130-330)	260 (100-490)	290 (110-550)	-	720 (395-985)	805 (440-1105)
N1	PMXxx .6 .8 -EB25/EB30	.004-.008	.004-.012	.031-.087	.039-.110	.047-.138	165 (100-330)	-	-	-	-	-	-
N2	PMXxx .6 .8 -EB25/EB30	.004-.008	.004-.012	.031-.087	.039-.110	.047-.138	165 (100-330)	-	-	-	-	-	-
N3	PMXxx .6 .8 -EB25/EB30	.004-.008	.004-.012	.031-.087	.039-.110	.047-.138	165 (100-330)	-	-	-	-	-	-
N11	PMXxx .6 .8 -EB25/EB30	.004-.008	.004-.012	.031-.087	.039-.110	.047-.138	165 (100-330)	-	-	-	-	-	-
PM1	PMXxx .6 .8 -EB25/EB30	.004-.008	.004-.012	.020-.071	.031-.079	.039-.098	-	165 (100-260)	230 (130-330)	-	-	-	-
PM2	PMXxx .6 .8 -EB25/EB30	.004-.008	.004-.012	.020-.071	.031-.079	.039-.098	-	165 (100-260)	230 (130-330)	-	-	-	-
PM3	PMXxx .6 .8 -EB25/EB30	.004-.008	.004-.012	.020-.071	.031-.079	.039-.098	-	165 (100-260)	230 (130-330)	-	-	-	-

SMG = Gruppo materiale Seco

a_p = inch

f = in/rev

v_c = sf/min

Tutti i parametri di taglio sono valori di partenza

Introduzione

Foratura

Alesatura

Barenatura

Allegato



Nanofix™

Gli alesatori Nanofix™ in metallo duro integrale sono progettati per diametri piccoli, compresi tra 2,97 e 12,05 mm (0.117" – 0.474").

- Adduzione refrigerante con un sistema semplice e regolabile in modo che l'attacco possa essere impostato per foro passante o per foro cieco, in funzione dell'applicazione.
- Consente tolleranze tra 10 e 15µm (0,0004-0,0006')
- Otto geometrie disponibili: EB45, EBS45, EB845, EB25, EB30, EBS30, EB60 e EB75

Panoramica della gamma

	Gamma ∅	Profondità di alesatura	Tolleranza ∅ foro	Diametro intermedio	Finitura superficiale
<p>Nanofix™</p> 	2,97-12,05 mm (0.1169-0.4744")	5-12 x D	IT 7	Disponibile tramite My Design	R _a 0,2-1,2 μm (R _a 7.87-47.2 μin)

Nanofix™ è un programma di alesatori in metallo duro integrale Seco dedicato per ∅ di piccole dimensioni da 2,97 a 12,05 mm (da 0,1169 a 0,4744").

Il design include un esclusivo sistema di bloccaggio brevettato Quick-fit che consente di bloccare l'intera gamma di diametri con solo 2 portautensili.

I portautensili sono dotati di sistema di adduzione refrigerante interna, semplice e regolabile, in modo da poter definire l'adduzione per fori passanti o ciechi, in base all'applicazione.

Quick-fit

Quick-fit

Cambio utensile rapido e facile.
Preciso riposizionamento in eccentricità e lunghezza.



2 portautensili Quick-Fit per coprire tutta la gamma diametrale



Quick-fit \varnothing 10 mm per
 \varnothing 6,051-12,050 mm
(\varnothing 0,2382-0,4744")



Quick-fit \varnothing 6 mm per
 \varnothing 2,97-6,050 mm
(\varnothing 0,1169-0,2382")

Unico utensile per applicazioni su fori ciechi e su fori passanti



passante

Ruotate la vite di regolazione del sistema di lubrefrigerazione di 1/4 di giro per passare dalla refrigerazione per fori ciechi a quella per fori passanti e viceversa.



cieco

Chiavi di codifica

Steli

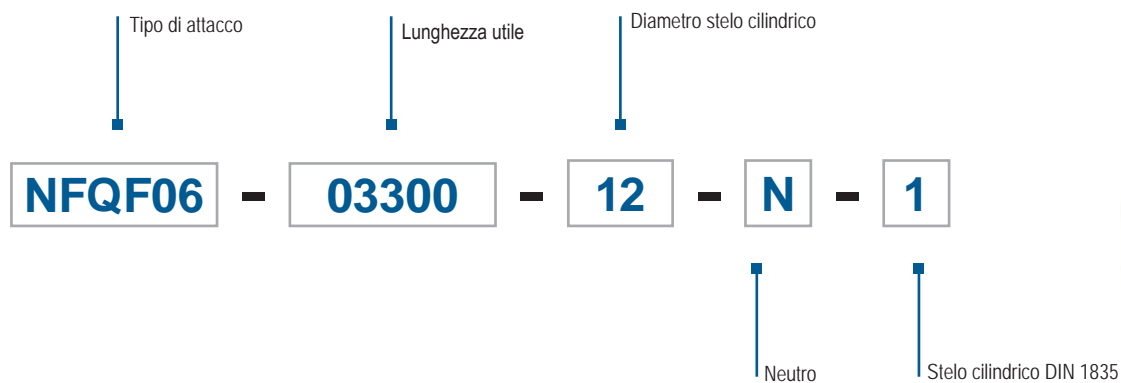

Alesatori

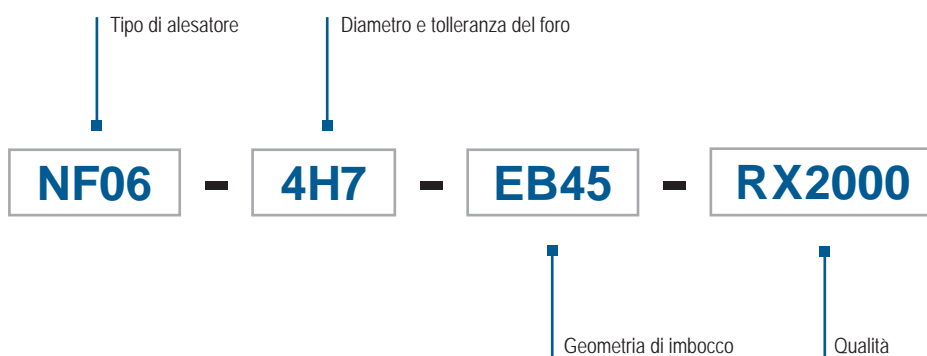

Alesatori di diametro intermedio

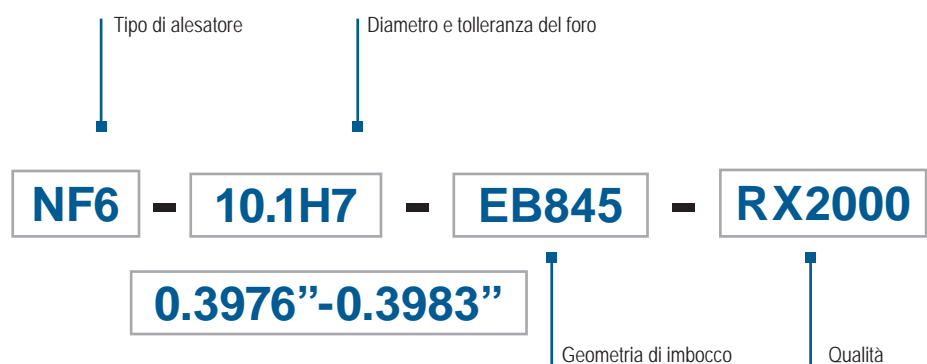

NF06/NF10/NS06/NS10: Design a scanalature dritte, adatto per fori passanti e ciechi.

NF4/NS4: Versione elicoidale DX, adatta solo a fori ciechi.

NF6/NS6: Versione elicoidale SX, adatta solo a fori passanti.

L'elica sinistra facilita l'evacuazione del truciolo in avanti.

L'elica destra facilita l'evacuazione del truciolo all'indietro.

Si vedano la pagine 373 e seguenti relative alla scelta delle geometrie Nanofix

Eccentricità

Introduzione

Utensile rotante

Massima eccentricità raccomandata: $5\ \mu\text{m}$ ($197\ \mu\text{in}$).
Si raccomanda un attacco di precisione: Attacco idraulico, porta pinze 5672.

Nota: a causa dell'anello di tenuta per l'orientamento del flusso refrigerante, l'uso degli attacchi a calettamento termico è sconsigliato.



Foratura

Utensile statico

Utilizzare un attacco flottante Seco, vedere le pagine 505-509.

Gli attacchi flottanti consentono all'alesatore di auto-centrarsi nel preforo.



Alesatura

Requisiti del refrigerante

Per la massima durata utensile ed una buona qualità del foro, si devono soddisfare i seguenti requisiti relativi al refrigerante.

Si raccomanda l'adduzione del refrigerante attraverso l'utensile.
L'adduzione esterna è possibile se le condizioni di taglio sono ridotte del 75%.

Olio solubile con almeno il 40% di olio minerale.
Per l'acciaio inossidabile si consiglia olio puro.

Concentrazione minima 6-8%.
Filtrazione $30\text{-}50\ \mu\text{m}$ ($1181\text{-}1969\ \mu\text{in}$).
Volume minimo $0,5\ \text{l/min/mm}$ ($0,13\ \text{gal/min/pollici}$) in rapporto al diametro utensile (esempio: alesatore $\varnothing 10$, il volume minimo è $5\ \text{l/min}$ ($1,3\ \text{gal/min}$)).



Barenatura

Misura diametro

Calibrare il micrometro a quadrante prima della misura del \varnothing .

Importante!
Gli alesatori Nanofix hanno passo differenziato.
Durante la misura del diametro, è necessario assicurarsi di misurare due lame opposte a 180° .

Per le rilevazioni, utilizzare un micrometro a quadrante e dei tastatori comparatori.

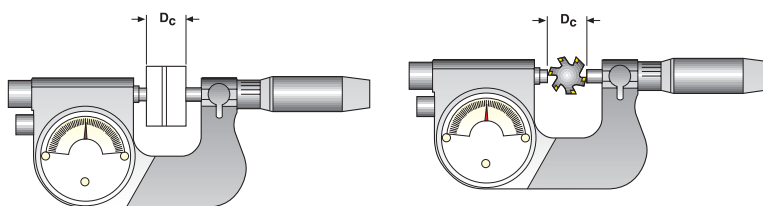

Allegato

Scelta della geometria della scanalatura

Pezzo in lavorazione	Diametro da alesare \varnothing 2,97-12,50 mm (0,1169-0,4744")	
<p>Foro passante corto < 3 x D</p> 	<p>Scanalature dritte</p> <p>NF06 NS06 NF10 NS10</p>	
<p>Foro passante lungo > 3 x D</p> 	<p>Scanalature elicoidali SX</p> <p>NF6 NS6</p>	
<p>Foro passante attraverso un foro preesistente</p> 		
<p>Foro cieco</p> 	<p>Scanalature dritte</p> <p>NF06 NS06 NF10 NS10</p>	
<p>Foro cieco attraverso un foro preesistente</p> 		
<p>Foro cieco > 3x D</p> 	<p>Scanalature elicoidali DX</p> <p>NF4 NS4</p>	

Scelta della geometria – Applicazioni

Introduzione	<h3>Geometria di imbocco - EB45</h3>	
	<p>Controllo truciolo ++ Finitura superficiale+++ R_a 0,8-1,2 μm (Finitura superficiale+++ R_a 31-47 μin) Versatile</p>	
Foratura	<h3>Geometria di imbocco - EBS45</h3>	
	<p>Controllo truciolo +++ Finitura superficiale + R_a 0,8-1,2 (Finitura superficiale + R_a 31-47 μin) EB45 corto</p>	
Alesatura	<h3>Geometria di imbocco - EB845</h3>	
	<p>Controllo truciolo ++ Finitura superficiale+++ R_a 0,2-0,8 μm (Finitura superficiale+++ R_a 8-31 μin)</p>	

Barenatura

Allegato

Scelta della geometria – Applicazioni

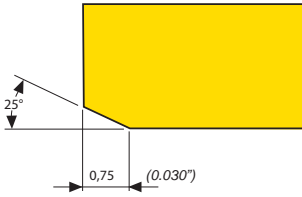
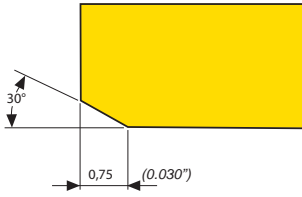
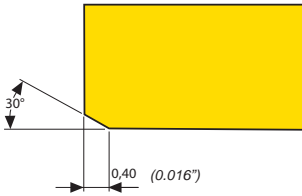



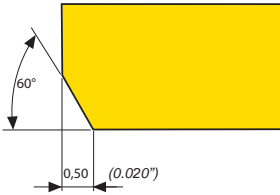
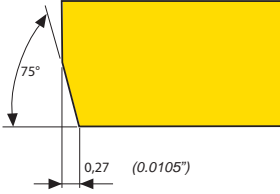



Geometria di imbocco - EB25	
<p>Possibilità di avanzamenti elevati +++ Finitura superficiale ++ R_a 0,4-0,8 μm (Finitura superficiale ++ R_a 16-31 μin) Controllo truciolo +</p>	
Geometria di imbocco - EB30	
<p>Possibilità di avanzamenti elevati +++ Finitura superficiale ++ (R_a 0,4-0,8 μm) (Finitura superficiale ++ R_a 16-31 μin) Controllo truciolo +</p>	
Geometria di imbocco - EBS30	
<p>Possibilità di avanzamenti elevati +++ Finitura superficiale ++ R_a 0,4-0,8 μm (Finitura superficiale ++ R_a 16-31 μin) Controllo truciolo + EB30 corto</p>	

Scelta della geometria – Applicazioni

Introduzione	<h3>Geometria di imbocco - EB60</h3>	
Foratura	<p>Possibilità di avanzamenti elevati + Finitura superficiale ++ R_a 0,8-1,2 μm (Finitura superficiale ++ R_a 31-47 μin) Controllo truciolo ++</p>	
Alesatura	<h3>Geometria di imbocco - EB75</h3> <p>Possibilità di avanzamenti elevati + Finitura superficiale ++ R_a 0,8-1,2 μm (Finitura superficiale ++ R_a 31-47 μin) Controllo truciolo ++</p>	

Barenatura

Allegato

Qualità		
	RX2000	Rivestita Qualità rivestita ad alte prestazioni per tutti i materiali da lavorare.
	CP20	Rivestita Qualità rivestita versatile adatta per la maggior parte dei materiali da lavorare, tranne l'alluminio. TIN
	H15	Non rivestita Qualità micrograna tenace per tutti i materiali da lavorare. Adatta per operazioni di finitura, grazie all'affilatura del tagliente.
	RN2010	Non rivestita Qualità sub-micrograna non rivestita con geometrie ottimizzate per materiali N (non ferrosi).
	RM2020	Rivestita Qualità rivestita tenace per operazioni di finitura con geometrie ottimizzate per materiali M.
	RM2090	Rivestita Qualità rivestita resistente all'usura con geometrie specifiche per materiali M. Ottimizzazione su materiali M.
	RK2050	Rivestita Qualità rivestita tenace per operazioni di finitura con geometrie ottimizzate per materiali K.
	RS2090	Rivestita Qualità rivestita resistente all'usura con geometrie specifiche per materiali S. Ottimizzazione su materiali S.

Alesatore per fori ciechi e passanti

Ø 2,97-12,05 mm / 0.116-0.474"

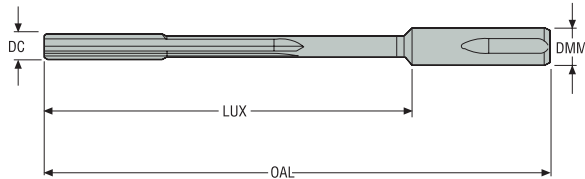

Codice di ordinazione	Codice prodotto	DC	Hole dia min-max		LUX	DMM	OAL		Geometrie			Qualità		
			mm Inch	mm Inch					mm Inch	mm Inch	mm Inch	mm Inch	EB45	EB845
NF06-2.98H7-EB45	02728853	2,98 0.1173	2,98 0.1173	2,99 0.1177	40,0 1.5750	6,0 0.2360	60,0 2.3620	4	<input checked="" type="checkbox"/>	<input type="checkbox"/>	<input type="checkbox"/>	<input checked="" type="checkbox"/>	<input type="checkbox"/>	<input type="checkbox"/>
NF06-2.99H7-EB45	02728854	2,99 0.1177	2,99 0.1177	3,0 0.1181	40,0 1.5750	6,0 0.2360	60,0 2.3620	4	<input checked="" type="checkbox"/>	<input type="checkbox"/>	<input type="checkbox"/>	<input checked="" type="checkbox"/>	<input type="checkbox"/>	<input type="checkbox"/>
NF06-3H7-EB45	02728858	3,0 0.1181	3,0 0.1181	3,01 0.1185	40,0 1.5750	6,0 0.2360	60,0 2.3620	4	<input checked="" type="checkbox"/>	<input type="checkbox"/>	<input type="checkbox"/>	<input checked="" type="checkbox"/>	<input type="checkbox"/>	<input type="checkbox"/>
NF06-3.01H7-EB45	02728860	3,01 0.1185	3,01 0.1185	3,022 0.1190	40,0 1.5750	6,0 0.2360	60,0 2.3620	4	<input checked="" type="checkbox"/>	<input type="checkbox"/>	<input type="checkbox"/>	<input checked="" type="checkbox"/>	<input type="checkbox"/>	<input type="checkbox"/>
NF06-3.02H7-EB45	02728862	3,02 0.1189	3,02 0.1189	3,032 0.1194	40,0 1.5750	6,0 0.2360	60,0 2.3620	4	<input checked="" type="checkbox"/>	<input type="checkbox"/>	<input type="checkbox"/>	<input checked="" type="checkbox"/>	<input type="checkbox"/>	<input type="checkbox"/>
NF06-3.03H7-EB45	02728864	3,03 0.1193	3,03 0.1193	3,042 0.1198	40,0 1.5750	6,0 0.2360	60,0 2.3620	4	<input checked="" type="checkbox"/>	<input type="checkbox"/>	<input type="checkbox"/>	<input checked="" type="checkbox"/>	<input type="checkbox"/>	<input type="checkbox"/>
NF06-3.04H7-EB45	02728865	3,04 0.1197	3,04 0.1197	3,052 0.1202	40,0 1.5750	6,0 0.2360	60,0 2.3620	4	<input checked="" type="checkbox"/>	<input type="checkbox"/>	<input type="checkbox"/>	<input checked="" type="checkbox"/>	<input type="checkbox"/>	<input type="checkbox"/>
NF06-3.05H7-EB45	02728866	3,05 0.1201	3,05 0.1201	3,062 0.1206	40,0 1.5750	6,0 0.2360	60,0 2.3620	4	<input checked="" type="checkbox"/>	<input type="checkbox"/>	<input type="checkbox"/>	<input checked="" type="checkbox"/>	<input type="checkbox"/>	<input type="checkbox"/>
NF06-3.167H7-EB45	02761485	3,167 0.1247	3,167 0.1247	3,179 0.1252	60,0 2.3620	6,0 0.2360	80,0 3.1500	4	<input checked="" type="checkbox"/>	<input type="checkbox"/>	<input type="checkbox"/>	<input checked="" type="checkbox"/>	<input type="checkbox"/>	<input type="checkbox"/>
NF06-3.175H7-EB45	02761489	3,175 0.1250	3,175 0.1250	3,187 0.1255	60,0 2.3620	6,0 0.2360	80,0 3.1500	4	<input checked="" type="checkbox"/>	<input type="checkbox"/>	<input type="checkbox"/>	<input checked="" type="checkbox"/>	<input type="checkbox"/>	<input type="checkbox"/>
NF06-3.5H7-EB45	02728868	3,5 0.1378	3,5 0.1378	3,512 0.1383	60,0 2.3620	6,0 0.2360	80,0 3.1500	4	<input checked="" type="checkbox"/>	<input type="checkbox"/>	<input type="checkbox"/>	<input checked="" type="checkbox"/>	<input type="checkbox"/>	<input type="checkbox"/>
NF06-3.51H7-EB45	02728869	3,51 0.1382	3,51 0.1382	3,522 0.1387	60,0 2.3620	6,0 0.2360	80,0 3.1500	4	<input checked="" type="checkbox"/>	<input type="checkbox"/>	<input type="checkbox"/>	<input checked="" type="checkbox"/>	<input type="checkbox"/>	<input type="checkbox"/>
NF06-3.97H7-EB45	02728871	3,97 0.1563	3,97 0.1563	3,982 0.1568	60,0 2.3620	6,0 0.2360	80,0 3.1500	4	<input checked="" type="checkbox"/>	<input type="checkbox"/>	<input type="checkbox"/>	<input checked="" type="checkbox"/>	<input type="checkbox"/>	<input type="checkbox"/>
NF06-3.98H7-EB45	02728872	3,98 0.1567	3,98 0.1567	3,992 0.1572	60,0 2.3620	6,0 0.2360	80,0 3.1500	4	<input checked="" type="checkbox"/>	<input type="checkbox"/>	<input type="checkbox"/>	<input checked="" type="checkbox"/>	<input type="checkbox"/>	<input type="checkbox"/>
NF06-3.99H7-EB45	02728873	3,99 0.1571	3,99 0.1571	4,002 0.1576	60,0 2.3620	6,0 0.2360	80,0 3.1500	4	<input checked="" type="checkbox"/>	<input type="checkbox"/>	<input type="checkbox"/>	<input checked="" type="checkbox"/>	<input type="checkbox"/>	<input type="checkbox"/>
NF06-4H7-EB45	02728874	4,0 0.1575	4,0 0.1575	4,012 0.1580	60,0 2.3620	6,0 0.2360	80,0 3.1500	4	<input checked="" type="checkbox"/>	<input type="checkbox"/>	<input type="checkbox"/>	<input checked="" type="checkbox"/>	<input type="checkbox"/>	<input type="checkbox"/>
NF06-4.01H7-EB45	02728875	4,01 0.1579	4,01 0.1579	4,022 0.1583	60,0 2.3620	6,0 0.2360	80,0 3.1500	4	<input checked="" type="checkbox"/>	<input type="checkbox"/>	<input type="checkbox"/>	<input checked="" type="checkbox"/>	<input type="checkbox"/>	<input type="checkbox"/>
NF06-4.02H7-EB45	02728876	4,02 0.1583	4,02 0.1583	4,032 0.1587	60,0 2.3620	6,0 0.2360	80,0 3.1500	4	<input checked="" type="checkbox"/>	<input type="checkbox"/>	<input type="checkbox"/>	<input checked="" type="checkbox"/>	<input type="checkbox"/>	<input type="checkbox"/>
NF06-4.04H7-EB45	02728879	4,04 0.1591	4,04 0.1591	4,052 0.1595	60,0 2.3620	6,0 0.2360	80,0 3.1500	4	<input checked="" type="checkbox"/>	<input type="checkbox"/>	<input type="checkbox"/>	<input checked="" type="checkbox"/>	<input type="checkbox"/>	<input type="checkbox"/>
NF06-4.05H7-EB45	02728880	4,05 0.1594	4,05 0.1594	4,062 0.1599	60,0 2.3620	6,0 0.2360	80,0 3.1500	4	<input checked="" type="checkbox"/>	<input type="checkbox"/>	<input type="checkbox"/>	<input checked="" type="checkbox"/>	<input type="checkbox"/>	<input type="checkbox"/>
NF06-4.5H7-EB45	02728881	4,5 0.1772	4,5 0.1772	4,512 0.1776	60,0 2.3620	6,0 0.2360	80,0 3.1500	4	<input checked="" type="checkbox"/>	<input type="checkbox"/>	<input type="checkbox"/>	<input checked="" type="checkbox"/>	<input type="checkbox"/>	<input type="checkbox"/>
NF06-4.750H7-EB45	02761490	4,75 0.1870	4,75 0.1870	4,762 0.1875	60,0 2.3620	6,0 0.2360	80,0 3.1500	4	<input checked="" type="checkbox"/>	<input type="checkbox"/>	<input type="checkbox"/>	<input checked="" type="checkbox"/>	<input type="checkbox"/>	<input type="checkbox"/>
NF06-4.762H7-EB45	02761494	4,762 0.1875	4,762 0.1875	4,774 0.1880	60,0 2.3620	6,0 0.2360	80,0 3.1500	4	<input checked="" type="checkbox"/>	<input type="checkbox"/>	<input type="checkbox"/>	<input checked="" type="checkbox"/>	<input type="checkbox"/>	<input type="checkbox"/>

Introduzione

Foratura

Alesatura

Barenatura

Allegato

Codice di ordinazione	Codice prodotto	DC	Hole dia min-max		LUX	DMM	OAL		Geometrie			Qualità		
		mm Inch	mm Inch	mm Inch	mm Inch	mm Inch	mm Inch		mm Inch	EB45	EB845	EB30	RX2000	H15
NF06-4.97H7-EB45	02728882	4,97 0.1957	4,97 0.1957	4,982 0.1961	60,0 2.3620	6,0 0.2360	80,0 3.1500	4	<input checked="" type="checkbox"/>	<input type="checkbox"/>	<input type="checkbox"/>	<input checked="" type="checkbox"/>	<input type="checkbox"/>	<input type="checkbox"/>
NF06-4.98H7-EB45	02728883	4,98 0.1961	4,98 0.1961	4,992 0.1965	60,0 2.3620	6,0 0.2360	80,0 3.1500	4	<input checked="" type="checkbox"/>	<input type="checkbox"/>	<input type="checkbox"/>	<input checked="" type="checkbox"/>	<input type="checkbox"/>	<input type="checkbox"/>
NF06-4.99H7-EB45	02728884	4,99 0.1965	4,99 0.1965	5,002 0.1969	60,0 2.3620	6,0 0.2360	80,0 3.1500	4	<input checked="" type="checkbox"/>	<input type="checkbox"/>	<input type="checkbox"/>	<input checked="" type="checkbox"/>	<input type="checkbox"/>	<input type="checkbox"/>
NF06-5H7-EB45	02728927	5,0 0.1969	5,0 0.1969	5,012 0.1973	60,0 2.3620	6,0 0.2360	80,0 3.1500	4	<input checked="" type="checkbox"/>	<input type="checkbox"/>	<input type="checkbox"/>	<input checked="" type="checkbox"/>	<input type="checkbox"/>	<input type="checkbox"/>
NF06-5.01H7-EB45	02728928	5,01 0.1972	5,01 0.1972	5,022 0.1977	60,0 2.3620	6,0 0.2360	80,0 3.1500	4	<input checked="" type="checkbox"/>	<input type="checkbox"/>	<input type="checkbox"/>	<input checked="" type="checkbox"/>	<input type="checkbox"/>	<input type="checkbox"/>
NF06-5.02H7-EB45	02728929	5,02 0.1976	5,02 0.1976	5,032 0.1981	60,0 2.3620	6,0 0.2360	80,0 3.1500	4	<input checked="" type="checkbox"/>	<input type="checkbox"/>	<input type="checkbox"/>	<input checked="" type="checkbox"/>	<input type="checkbox"/>	<input type="checkbox"/>
NF06-5.03H7-EB45	02728930	5,03 0.1980	5,03 0.1980	5,042 0.1985	60,0 2.3620	6,0 0.2360	80,0 3.1500	4	<input checked="" type="checkbox"/>	<input type="checkbox"/>	<input type="checkbox"/>	<input checked="" type="checkbox"/>	<input type="checkbox"/>	<input type="checkbox"/>
NF06-5.05H7-EB45	02728932	5,05 0.1988	5,05 0.1988	5,062 0.1993	60,0 2.3620	6,0 0.2360	80,0 3.1500	4	<input checked="" type="checkbox"/>	<input type="checkbox"/>	<input type="checkbox"/>	<input checked="" type="checkbox"/>	<input type="checkbox"/>	<input type="checkbox"/>
NF06-5.5H7-EB45	02728933	5,5 0.2165	5,5 0.2165	5,512 0.2170	60,0 2.3620	6,0 0.2360	80,0 3.1500	4	<input checked="" type="checkbox"/>	<input type="checkbox"/>	<input type="checkbox"/>	<input checked="" type="checkbox"/>	<input type="checkbox"/>	<input type="checkbox"/>
NF06-5.97H7-EB45	02728934	5,97 0.2350	5,97 0.2350	5,982 0.2355	60,0 2.3620	6,0 0.2360	80,0 3.1500	4	<input checked="" type="checkbox"/>	<input type="checkbox"/>	<input type="checkbox"/>	<input checked="" type="checkbox"/>	<input type="checkbox"/>	<input type="checkbox"/>
NF06-5.98H7-EB45	02728935	5,98 0.2354	5,98 0.2354	5,992 0.2359	60,0 2.3620	6,0 0.2360	80,0 3.1500	4	<input checked="" type="checkbox"/>	<input type="checkbox"/>	<input type="checkbox"/>	<input checked="" type="checkbox"/>	<input type="checkbox"/>	<input type="checkbox"/>
NF06-5.99H7-EB45	02728936	5,99 0.2358	5,99 0.2358	6,002 0.2363	60,0 2.3620	6,0 0.2360	80,0 3.1500	4	<input checked="" type="checkbox"/>	<input type="checkbox"/>	<input type="checkbox"/>	<input checked="" type="checkbox"/>	<input type="checkbox"/>	<input type="checkbox"/>
NF06-6H7-EB45	02728937	6,0 0.2362	6,0 0.2362	6,015 0.2368	60,0 2.3620	6,0 0.2360	80,0 3.1500	4	<input checked="" type="checkbox"/>	<input type="checkbox"/>	<input type="checkbox"/>	<input checked="" type="checkbox"/>	<input type="checkbox"/>	<input type="checkbox"/>
NF06-6.01H7-EB45	02728938	6,01 0.2366	6,01 0.2366	6,025 0.2372	60,0 2.3620	6,0 0.2360	80,0 3.1500	4	<input checked="" type="checkbox"/>	<input type="checkbox"/>	<input type="checkbox"/>	<input checked="" type="checkbox"/>	<input type="checkbox"/>	<input type="checkbox"/>
NF06-6.02H7-EB45	02728939	6,02 0.2370	6,02 0.2370	6,035 0.2376	60,0 2.3620	6,0 0.2360	80,0 3.1500	4	<input checked="" type="checkbox"/>	<input type="checkbox"/>	<input type="checkbox"/>	<input checked="" type="checkbox"/>	<input type="checkbox"/>	<input type="checkbox"/>
NF06-6.03H7-EB45	02728940	6,03 0.2374	6,03 0.2374	6,045 0.2380	60,0 2.3620	6,0 0.2360	80,0 3.1500	4	<input checked="" type="checkbox"/>	<input type="checkbox"/>	<input type="checkbox"/>	<input checked="" type="checkbox"/>	<input type="checkbox"/>	<input type="checkbox"/>
NF06-6.04H7-EB45	02728941	6,04 0.2378	6,04 0.2378	6,055 0.2384	60,0 2.3620	6,0 0.2360	80,0 3.1500	4	<input checked="" type="checkbox"/>	<input type="checkbox"/>	<input type="checkbox"/>	<input checked="" type="checkbox"/>	<input type="checkbox"/>	<input type="checkbox"/>
NF06-6.05H7-EB45	02728942	6,05 0.2382	6,05 0.2382	6,065 0.2388	60,0 2.3620	6,0 0.2360	80,0 3.1500	4	<input checked="" type="checkbox"/>	<input type="checkbox"/>	<input type="checkbox"/>	<input checked="" type="checkbox"/>	<input type="checkbox"/>	<input type="checkbox"/>
NF10-6.334H7-EB45	02761987	6,334 0.2494	6,33 0.2492	6,345 0.2498	83,0 3.2680	10,0 0.3940	115,0 4.5280	6	<input checked="" type="checkbox"/>	<input type="checkbox"/>	<input type="checkbox"/>	<input checked="" type="checkbox"/>	<input type="checkbox"/>	<input type="checkbox"/>
NF10-6.350H7-EB45	02762016	6,35 0.2500	6,35 0.2500	6,365 0.2506	83,0 3.2680	10,0 0.3940	115,0 4.5280	6	<input checked="" type="checkbox"/>	<input type="checkbox"/>	<input type="checkbox"/>	<input checked="" type="checkbox"/>	<input type="checkbox"/>	<input type="checkbox"/>
NF10-6.3754H7-EB45	02762017	6,375 0.2510	6,375 0.2510	6,39 0.2516	83,0 3.2680	10,0 0.3940	115,0 4.5280	6	<input checked="" type="checkbox"/>	<input type="checkbox"/>	<input type="checkbox"/>	<input checked="" type="checkbox"/>	<input type="checkbox"/>	<input type="checkbox"/>
NF10-6.5H7-EB45	02728943	6,5 0.2559	6,5 0.2559	6,515 0.2565	83,0 3.2680	10,0 0.3940	115,0 4.5280	6	<input checked="" type="checkbox"/>	<input type="checkbox"/>	<input type="checkbox"/>	<input checked="" type="checkbox"/>	<input type="checkbox"/>	<input type="checkbox"/>
NF10-6.98H7-EB45	02728947	6,98 0.2748	6,98 0.2748	6,995 0.2754	83,0 3.2680	10,0 0.3940	115,0 4.5280	6	<input checked="" type="checkbox"/>	<input type="checkbox"/>	<input type="checkbox"/>	<input checked="" type="checkbox"/>	<input type="checkbox"/>	<input type="checkbox"/>
NF10-7H7-EB45	02728949	7,0 0.2756	7,0 0.2756	7,015 0.2762	83,0 3.2680	10,0 0.3940	115,0 4.5280	6	<input checked="" type="checkbox"/>	<input type="checkbox"/>	<input type="checkbox"/>	<input checked="" type="checkbox"/>	<input type="checkbox"/>	<input type="checkbox"/>
NF10-7.01H7-EB45	02728950	7,01 0.2760	7,01 0.2760	7,025 0.2766	83,0 3.2680	10,0 0.3940	115,0 4.5280	6	<input checked="" type="checkbox"/>	<input type="checkbox"/>	<input type="checkbox"/>	<input checked="" type="checkbox"/>	<input type="checkbox"/>	<input type="checkbox"/>
NF10-7.02H7-EB45	02728951	7,02 0.2764	7,02 0.2764	7,035 0.2770	83,0 3.2680	10,0 0.3940	115,0 4.5280	6	<input checked="" type="checkbox"/>	<input type="checkbox"/>	<input type="checkbox"/>	<input checked="" type="checkbox"/>	<input type="checkbox"/>	<input type="checkbox"/>
NF10-7.05H7-EB45	02728954	7,05 0.2776	7,05 0.2776	7,065 0.2781	83,0 3.2680	10,0 0.3940	115,0 4.5280	6	<input checked="" type="checkbox"/>	<input type="checkbox"/>	<input type="checkbox"/>	<input checked="" type="checkbox"/>	<input type="checkbox"/>	<input type="checkbox"/>
NF10-7.5H7-EB45	02728955	7,5 0.2953	7,5 0.2953	7,515 0.2959	83,0 3.2680	10,0 0.3940	115,0 4.5280	6	<input checked="" type="checkbox"/>	<input type="checkbox"/>	<input type="checkbox"/>	<input checked="" type="checkbox"/>	<input type="checkbox"/>	<input type="checkbox"/>
NF10-7.9375H7-EB45	02762018	7,9375 0.3125	7,937 0.3125	7,952 0.3131	83,0 3.2680	10,0 0.3940	115,0 4.5280	6	<input checked="" type="checkbox"/>	<input type="checkbox"/>	<input type="checkbox"/>	<input checked="" type="checkbox"/>	<input type="checkbox"/>	<input type="checkbox"/>
NF10-7.97H7-EB45	02728956	7,97 0.3138	7,97 0.3138	7,985 0.3144	83,0 3.2680	10,0 0.3940	115,0 4.5280	6	<input checked="" type="checkbox"/>	<input type="checkbox"/>	<input type="checkbox"/>	<input checked="" type="checkbox"/>	<input type="checkbox"/>	<input type="checkbox"/>

Introduzione

Foratura

Alesatura

Barenatura

Allegato

Codice di ordinazione	Codice prodotto	DC	Hole dia min-max		LUX	DMM	OAL		Geometrie			Qualità		
			mm Inch	mm Inch					mm Inch	mm Inch	mm Inch	mm Inch	mm Inch	mm Inch
NF10-7.98H7-EB45	02728957	7,98 0.3142	7,98 0.3142	7,995 0.3148	83,0 3.2680	10,0 0.3940	115,0 4.5280	6	■	□	□	■	□	□
NF10-7.99H7-EB45	02728958	7,99 0.3146	7,99 0.3146	8,005 0.3152	83,0 3.2680	10,0 0.3940	115,0 4.5280	6	■	□	□	■	□	□
NF10-8H7-EB45	02728959	8,0 0.3150	8,0 0.3150	8,015 0.3156	83,0 3.2680	10,0 0.3940	115,0 4.5280	6	■	□	□	■	□	□
NF10-8.01H7-EB45	02728960	8,01 0.3154	8,01 0.3154	8,025 0.3159	83,0 3.2680	10,0 0.3940	115,0 4.5280	6	■	□	□	■	□	□
NF10-8.02H7-EB45	02728961	8,02 0.3157	8,02 0.3157	8,035 0.3163	83,0 3.2680	10,0 0.3940	115,0 4.5280	6	■	□	□	■	□	□
NF10-8.03H7-EB45	02728962	8,03 0.3161	8,03 0.3161	8,045 0.3167	83,0 3.2680	10,0 0.3940	115,0 4.5280	6	■	□	□	■	□	□
NF10-8.04H7-EB45	02728963	8,04 0.3165	8,04 0.3165	8,055 0.3171	83,0 3.2680	10,0 0.3940	115,0 4.5280	6	■	□	□	■	□	□
NF10-8.05H7-EB45	02728964	8,05 0.3169	8,05 0.3169	8,065 0.3175	83,0 3.2680	10,0 0.3940	115,0 4.5280	6	■	□	□	■	□	□
NF10-8.5H7-EB45	02728965	8,5 0.3346	8,5 0.3346	8,515 0.3352	93,0 3.6610	10,0 0.3940	125,0 4.9210	6	■	□	□	■	□	□
NF10-9H7-EB45	02728974	9,0 0.3543	9,0 0.3543	9,015 0.3549	93,0 3.6610	10,0 0.3940	125,0 4.9210	6	■	□	□	■	□	□
NF10-9.01H7-EB45	02728975	9,01 0.3547	9,01 0.3547	9,025 0.3553	93,0 3.6610	10,0 0.3940	125,0 4.9210	6	■	□	□	■	□	□
NF10-9.05H7-EB45	02728979	9,05 0.3563	9,05 0.3563	9,065 0.3569	93,0 3.6610	10,0 0.3940	125,0 4.9210	6	■	□	□	■	□	□
NF10-9.5H7-EB45	02728980	9,5 0.3740	9,5 0.3740	9,515 0.3746	93,0 3.6610	10,0 0.3940	125,0 4.9210	6	■	□	□	■	□	□
NF10-9.5250H7-EB45	02762020	9,525 0.3750	9,525 0.3750	9,54 0.3756	93,0 3.6610	10,0 0.3940	125,0 4.9210	6	■	□	□	■	□	□
NF10-9.97H7-EB45	02728981	9,97 0.3925	9,97 0.3925	9,985 0.3931	93,0 3.6610	10,0 0.3940	125,0 4.9210	6	■	□	□	■	□	□
NF10-9.98H7-EB45	02728982	9,98 0.3929	9,98 0.3929	9,995 0.3935	93,0 3.6610	10,0 0.3940	125,0 4.9210	6	■	□	□	■	□	□
NF10-9.99H7-EB45	02728983	9,99 0.3933	9,99 0.3933	10,005 0.3939	93,0 3.6610	10,0 0.3940	125,0 4.9210	6	■	□	□	■	□	□
NF10-10H7-EB45	02728986	10,0 0.3937	10,0 0.3937	10,015 0.3943	93,0 3.6610	10,0 0.3940	125,0 4.9210	6	■	□	□	■	□	□
NF10-11H7-EB45	02728997	11,0 0.4331	11,0 0.4331	11,018 0.4338	114,0 4.4880	10,0 0.3940	145,0 5.7090	6	■	□	□	■	□	□
NF10-12H7-EB45	02729011	12,0 0.4724	12,0 0.4724	12,018 0.4731	114,0 4.4880	10,0 0.3940	145,0 5.7090	6	■	□	□	■	□	□

■ Prodotto standard a stock □ Prodotto standard non a stock.

Nota: Quando si ordinano alesatori Nanofix per diametri intermedi, indicare il diametro e la tolleranza del foro da alesare.

Esempio d'ordine: NF10-10.187/10.213-EB845, RX2000.

Diametro intermedio

Scanalature diritte, versione lunga, per fori passanti e ciechi

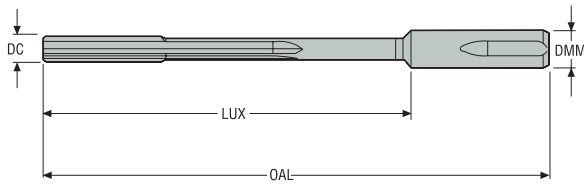

- Per la scelta della geometria, vedere le pagine 374-376
- Per i parametri di taglio raccomandati, vedere pagina(e) 393-400

Codice di ordinazione	DCN	DCX	LUX	DMM	OAL		Dimensione stelo	Geometrie	Qualità						
									H15	RK2050	RX2000	RN2010	RM2020	RM2090	RS2090
NF06-2.970-XX-XXXX	2,97 0.117	3,05 0.120	40,0 0.120	6,0 0.236	60,0 2.362	4	NFQF06-xx	EB45 EB845 EB30	<input type="checkbox"/>	<input type="checkbox"/>	<input type="checkbox"/>	<input type="checkbox"/>	<input type="checkbox"/>	<input type="checkbox"/>	<input type="checkbox"/>
NF06-3.051-XX-XXXX	3,051 0.120	6,05 0.238	60,0 0.238	6,0 0.236	80,0 3.150	4	NFQF06-xx	EB45 EB845 EB30	<input type="checkbox"/>	<input type="checkbox"/>	<input type="checkbox"/>	<input type="checkbox"/>	<input type="checkbox"/>	<input type="checkbox"/>	<input type="checkbox"/>
NF10-6.051-XX-XXXX	6,051 0.238	8,05 0.317	83,0 0.317	10,0 0.394	115,0 4.528	6	NFQF10-xx	EB45 EB845 EB30	<input type="checkbox"/>	<input type="checkbox"/>	<input type="checkbox"/>	<input type="checkbox"/>	<input type="checkbox"/>	<input type="checkbox"/>	<input type="checkbox"/>
NF10-8.051-XX-XXXX	8,051 0.317	10,05 0.396	93,0 0.396	10,0 0.394	125,0 4.921	6	NFQF10-xx	EB45 EB845 EB30	<input type="checkbox"/>	<input type="checkbox"/>	<input type="checkbox"/>	<input type="checkbox"/>	<input type="checkbox"/>	<input type="checkbox"/>	<input type="checkbox"/>
NF10-10.051-XX-XXXX	10,051 0.396	12,05 0.474	114,0 0.474	10,0 0.394	145,0 5.709	6	NFQF10-xx	EB45 EB845 EB30	<input type="checkbox"/>	<input type="checkbox"/>	<input type="checkbox"/>	<input type="checkbox"/>	<input type="checkbox"/>	<input type="checkbox"/>	<input type="checkbox"/>

= Prodotto standard non presente a magazzino

Nota: Quando si ordinano alesatori Nanofix per diametri intermedi, indicare il diametro e la tolleranza del foro da alesare.

Esempio d'ordine: NF06-5.187/5.213-EB845, RX2000.

Diametro intermedio

Scanalature elicoidali SX, versione lunga, per fori passanti

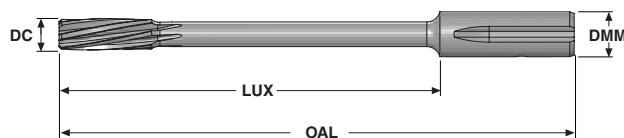

- Per la scelta della geometria, vedere le pagine 374-376
- Per i parametri di taglio raccomandati, vedere pagina(e) 393-400

Codice di ordinazione	DCN	DCX	LUX	DMM	OAL	Dimensione stelo	Geometrie	Qualità							
	mm Inch	mm Inch	mm Inch	mm Inch	mm Inch			mm Inch	H15	RK2050	RX2000	RN2010	RM2020	RM2090	RS2090
NF6-2.970-XX-XXXX	2,97 0.117	3,05 0.120	40,0 1.575	6,0 0.236	60,0 2.362	4	NFQF06-xx	EB45 EB845 EB30	<input type="checkbox"/>	<input type="checkbox"/>	<input type="checkbox"/>	<input type="checkbox"/>	<input type="checkbox"/>	<input type="checkbox"/>	<input type="checkbox"/>
NF6-3.051-XX-XXXX	3,051 0.120	6,05 0.238	60,0 2.362	6,0 0.236	80,0 3.150	4	NFQF06-xx	EB45 EB845 EB30	<input type="checkbox"/>	<input type="checkbox"/>	<input type="checkbox"/>	<input type="checkbox"/>	<input type="checkbox"/>	<input type="checkbox"/>	<input type="checkbox"/>
NF6-6.051-XX-XXXX	6,051 0.238	8,05 0.317	83,0 3.268	10,0 0.394	115,0 4.528	6	NFQF10-xx	EB45 EB845 EB30	<input type="checkbox"/>	<input type="checkbox"/>	<input type="checkbox"/>	<input type="checkbox"/>	<input type="checkbox"/>	<input type="checkbox"/>	<input type="checkbox"/>
NF6-8.051-XX-XXXX	8,051 0.317	10,05 0.396	93,0 3.661	10,0 0.394	125,0 4.921	6	NFQF10-xx	EB45 EB845 EB30	<input type="checkbox"/>	<input type="checkbox"/>	<input type="checkbox"/>	<input type="checkbox"/>	<input type="checkbox"/>	<input type="checkbox"/>	<input type="checkbox"/>
NF6-10.051-XX-XXXX	10,051 0.396	12,05 0.474	114,0 4.488	10,0 0.394	145,0 5.709	6	NFQF10-xx	EB45 EB845 EB30	<input type="checkbox"/>	<input type="checkbox"/>	<input type="checkbox"/>	<input type="checkbox"/>	<input type="checkbox"/>	<input type="checkbox"/>	<input type="checkbox"/>

= Prodotto standard non presente a magazzino

Nota: Quando si ordinano alesatori Nanofix per diametri intermedi, indicare il diametro e la tolleranza del foro da alesare.

Esempio d'ordine: NF6-5.187/5.213-EB845, RX2000.

Diametro intermedio

Scanalature elicoidali DX, versione lunga, per fori ciechi



- Per la scelta della geometria, vedere le pagine 374-376
- Per i parametri di taglio raccomandati, vedere pagina(e) 393-400

Codice di ordinazione	DCN	DCX	LUX	DMM	OAL	Dimensione stelo	Geometrie	Qualità							
								H15	RK2050	RX2000	RN2010	RM2020	RM2090	RS2090	
NF4-2.970-XX-XXXX	2,97 0.117	3,05 0.120	40,0 1.575	6,0 0.236	60,0 2.362	4	NFQF06-xx	EB45 EB845	<input type="checkbox"/>	<input type="checkbox"/>	<input type="checkbox"/>	<input type="checkbox"/>	<input type="checkbox"/>	<input type="checkbox"/>	<input type="checkbox"/>
NF4-3.051-XX-XXXX	3,051 0.120	6,05 0.238	60,0 2.362	6,0 0.236	80,0 3.150	4	NFQF06-xx	EB45 EB845	<input type="checkbox"/>	<input type="checkbox"/>	<input type="checkbox"/>	<input type="checkbox"/>	<input type="checkbox"/>	<input type="checkbox"/>	<input type="checkbox"/>
NF4-4.051-XX-XXXX	6,051 0.238	8,05 0.317	83,0 3.268	10,0 0.394	115,0 4.528	6	NFQF10-xx	EB45 EB845	<input type="checkbox"/>	<input type="checkbox"/>	<input type="checkbox"/>	<input type="checkbox"/>	<input type="checkbox"/>	<input type="checkbox"/>	<input type="checkbox"/>
NF4-8.051-XX-XXXX	8,051 0.317	10,05 0.396	93,0 3.661	10,0 0.394	125,0 4.921	6	NFQF10-xx	EB45 EB845	<input type="checkbox"/>	<input type="checkbox"/>	<input type="checkbox"/>	<input type="checkbox"/>	<input type="checkbox"/>	<input type="checkbox"/>	<input type="checkbox"/>
NF4-10.051-XX-XXXX	10,051 0.396	12,05 0.474	114,0 4.488	10,0 0.394	145,0 5.709	6	NFQF10-xx	EB45 EB845	<input type="checkbox"/>	<input type="checkbox"/>	<input type="checkbox"/>	<input type="checkbox"/>	<input type="checkbox"/>	<input type="checkbox"/>	<input type="checkbox"/>

= Prodotto standard non presente a magazzino

Nota: Quando si ordinano alesatori Nanofix per diametri intermedi, indicare il diametro e la tolleranza del foro da alesare.

Esempio d'ordine: NF4-10.187/10.213-EB845, RX2000.

Alesatore per fori ciechi e passanti – versione corta

Ø 2,97-12,05 mm / 0.116-0.474"

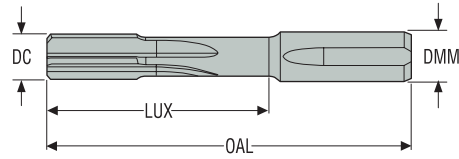

Codice di ordinazione	Codice prodotto	DC	Hole dia min-max		LUX	DMM	OAL		Geometrie			Qualità		
			mm Inch	mm Inch					mm Inch	mm Inch	mm Inch	mm Inch	mm Inch	mm Inch
NS06-2.97H7-EB...	-	2,97 0.1169	2,97 0.1169	2,98 0.1173	25,0 0.9840	6,0 0.2360	45,0 1.7720	4	<input type="checkbox"/>	<input type="checkbox"/>	<input type="checkbox"/>	<input type="checkbox"/>	<input type="checkbox"/>	<input type="checkbox"/>
NS06-2.98H7-EB...	-	2,98 0.1173	2,98 0.1173	2,99 0.1177	25,0 0.9840	6,0 0.2360	45,0 1.7720	4	<input type="checkbox"/>	<input type="checkbox"/>	<input type="checkbox"/>	<input type="checkbox"/>	<input type="checkbox"/>	<input type="checkbox"/>
NS06-2.99H7-EB...	-	2,99 0.1177	2,99 0.1177	3,00 0.1181	25,0 0.9840	6,0 0.2360	45,0 1.7720	4	<input type="checkbox"/>	<input type="checkbox"/>	<input type="checkbox"/>	<input type="checkbox"/>	<input type="checkbox"/>	<input type="checkbox"/>
NS06-3.00H7-EB...	-	3,0 0.1181	3,00 0.1181	3,01 0.1185	25,0 0.9840	6,0 0.2360	45,0 1.7720	4	<input type="checkbox"/>	<input type="checkbox"/>	<input type="checkbox"/>	<input type="checkbox"/>	<input type="checkbox"/>	<input type="checkbox"/>
NS06-3H7-EB30	10019456	3,0 0.1181	3,01 0.1185	3,00 0.1181	25,0 0.9840	6,0 0.2360	45,0 1.7720	4	<input type="checkbox"/>	<input type="checkbox"/>	<input checked="" type="checkbox"/>	<input checked="" type="checkbox"/>	<input type="checkbox"/>	<input type="checkbox"/>
NS06-3.01H7-EB...	-	3,01 0.1185	3,01 0.1185	3,02 0.1190	25,0 0.9840	6,0 0.2360	45,0 1.7720	4	<input type="checkbox"/>	<input type="checkbox"/>	<input type="checkbox"/>	<input type="checkbox"/>	<input type="checkbox"/>	<input type="checkbox"/>
NS06-3.02H7-EB...	-	3,02 0.1189	3,02 0.1189	3,03 0.1194	25,0 0.9840	6,0 0.2360	45,0 1.7720	4	<input type="checkbox"/>	<input type="checkbox"/>	<input type="checkbox"/>	<input type="checkbox"/>	<input type="checkbox"/>	<input type="checkbox"/>
NS06-3.03H7-EB...	-	3,03 0.1193	3,03 0.1193	3,04 0.1198	25,0 0.9840	6,0 0.2360	45,0 1.7720	4	<input type="checkbox"/>	<input type="checkbox"/>	<input type="checkbox"/>	<input type="checkbox"/>	<input type="checkbox"/>	<input type="checkbox"/>
NS06-3.04H7-EB...	-	3,04 0.1197	3,04 0.1197	3,05 0.1202	25,0 0.9840	6,0 0.2360	45,0 1.7720	4	<input type="checkbox"/>	<input type="checkbox"/>	<input type="checkbox"/>	<input type="checkbox"/>	<input type="checkbox"/>	<input type="checkbox"/>
NS06-3.05H7-EB...	-	3,05 0.1201	3,05 0.1201	3,06 0.1206	25,0 0.9840	6,0 0.2360	45,0 1.7720	4	<input type="checkbox"/>	<input type="checkbox"/>	<input type="checkbox"/>	<input type="checkbox"/>	<input type="checkbox"/>	<input type="checkbox"/>
NS06-3.167H7-EB...	-	3,167 0.1247	3,18 0.1252	3,17 0.1247	30,0 1.1810	6,0 0.2360	50,0 1.9690	4	<input type="checkbox"/>	<input type="checkbox"/>	<input type="checkbox"/>	<input type="checkbox"/>	<input type="checkbox"/>	<input type="checkbox"/>
NS06-3.175H7-EB...	-	3,175 0.1250	3,18 0.1250	3,19 0.1255	30,0 1.1810	6,0 0.2360	50,0 1.9690	4	<input type="checkbox"/>	<input type="checkbox"/>	<input type="checkbox"/>	<input type="checkbox"/>	<input type="checkbox"/>	<input type="checkbox"/>
NS06-3.49H7-EB...	-	3,49 0.1374	3,49 0.1374	3,50 0.1379	30,0 1.1810	6,0 0.2360	50,0 1.9690	4	<input type="checkbox"/>	<input type="checkbox"/>	<input type="checkbox"/>	<input type="checkbox"/>	<input type="checkbox"/>	<input type="checkbox"/>
NS06-3.50H7-EB...	-	3,5 0.1378	3,50 0.1378	3,51 0.1383	30,0 1.1810	6,0 0.2360	50,0 1.9690	4	<input type="checkbox"/>	<input type="checkbox"/>	<input type="checkbox"/>	<input type="checkbox"/>	<input type="checkbox"/>	<input type="checkbox"/>
NS06-3.51H7-EB...	-	3,51 0.1382	3,51 0.1382	3,52 0.1387	30,0 1.1810	6,0 0.2360	50,0 1.9690	4	<input type="checkbox"/>	<input type="checkbox"/>	<input type="checkbox"/>	<input type="checkbox"/>	<input type="checkbox"/>	<input type="checkbox"/>
NS06-3.52H7-EB...	-	3,52 0.1386	3,52 0.1386	3,53 0.1391	30,0 1.1810	6,0 0.2360	50,0 1.9690	4	<input type="checkbox"/>	<input type="checkbox"/>	<input type="checkbox"/>	<input type="checkbox"/>	<input type="checkbox"/>	<input type="checkbox"/>
NS06-3.97H7-EB...	-	3,97 0.1563	3,97 0.1563	3,98 0.1568	30,0 1.1810	6,0 0.2360	50,0 1.9690	4	<input type="checkbox"/>	<input type="checkbox"/>	<input type="checkbox"/>	<input type="checkbox"/>	<input type="checkbox"/>	<input type="checkbox"/>
NS06-3.98H7-EB...	-	3,98 0.1567	3,98 0.1567	3,99 0.1572	30,0 1.1810	6,0 0.2360	50,0 1.9690	4	<input type="checkbox"/>	<input type="checkbox"/>	<input type="checkbox"/>	<input type="checkbox"/>	<input type="checkbox"/>	<input type="checkbox"/>
NS06-3.99H7-EB...	-	3,99 0.1571	3,99 0.1571	4,00 0.1576	30,0 1.1810	6,0 0.2360	50,0 1.9690	4	<input type="checkbox"/>	<input type="checkbox"/>	<input type="checkbox"/>	<input type="checkbox"/>	<input type="checkbox"/>	<input type="checkbox"/>
NS06-4.00H7-EB...	-	4,0 0.1575	4,00 0.1575	4,01 0.1580	30,0 1.1810	6,0 0.2360	50,0 1.9690	4	<input type="checkbox"/>	<input type="checkbox"/>	<input type="checkbox"/>	<input type="checkbox"/>	<input type="checkbox"/>	<input type="checkbox"/>
NS06-4H7-EB30	10019457	4,0 0.1575	4,01 0.1580	4,00 0.1575	30,0 1.1810	6,0 0.2360	50,0 1.9690	4	<input type="checkbox"/>	<input type="checkbox"/>	<input checked="" type="checkbox"/>	<input checked="" type="checkbox"/>	<input type="checkbox"/>	<input type="checkbox"/>
NS06-4.01H7-EB...	-	4,01 0.1579	4,01 0.1579	4,02 0.1583	30,0 1.1810	6,0 0.2360	50,0 1.9690	4	<input type="checkbox"/>	<input type="checkbox"/>	<input type="checkbox"/>	<input type="checkbox"/>	<input type="checkbox"/>	<input type="checkbox"/>
NS06-4.02H7-EB...	-	4,02 0.1583	4,02 0.1583	4,03 0.1587	30,0 1.1810	6,0 0.2360	50,0 1.9690	4	<input type="checkbox"/>	<input type="checkbox"/>	<input type="checkbox"/>	<input type="checkbox"/>	<input type="checkbox"/>	<input type="checkbox"/>

Codice di ordinazione	Codice prodotto	DC	Hole dia min-max		LUX	DMM	OAL		Geometrie			Qualità		
			mm Inch	mm Inch					mm Inch	mm Inch	mm Inch	mm Inch	mm Inch	EB45
NS06-4.03H7-EB...	-	4,03 0.1587	4,03 0.1587	4,04 0.1591	30,0 1.1810	6,0 0.2360	50,0 1.9690	4	<input type="checkbox"/>	<input type="checkbox"/>	<input type="checkbox"/>	<input type="checkbox"/>	<input type="checkbox"/>	<input type="checkbox"/>
NS06-4.04H7-EB...	-	4,04 0.1591	4,04 0.1591	4,05 0.1595	30,0 1.1810	6,0 0.2360	50,0 1.9690	4	<input type="checkbox"/>	<input type="checkbox"/>	<input type="checkbox"/>	<input type="checkbox"/>	<input type="checkbox"/>	<input type="checkbox"/>
NS06-4.05H7-EB...	-	4,05 0.1594	4,05 0.1594	4,06 0.1599	30,0 1.1810	6,0 0.2360	50,0 1.9690	4	<input type="checkbox"/>	<input type="checkbox"/>	<input type="checkbox"/>	<input type="checkbox"/>	<input type="checkbox"/>	<input type="checkbox"/>
NS06-4.50H7-EB...	-	4,5 0.1772	4,50 0.1772	4,51 0.1776	30,0 1.1810	6,0 0.2360	50,0 1.9690	4	<input type="checkbox"/>	<input type="checkbox"/>	<input type="checkbox"/>	<input type="checkbox"/>	<input type="checkbox"/>	<input type="checkbox"/>
NS06-4.750H7-EB...	-	4,75 0.1870	4,75 0.1870	4,76 0.1875	30,0 1.1810	6,0 0.2360	50,0 1.9690	4	<input type="checkbox"/>	<input type="checkbox"/>	<input type="checkbox"/>	<input type="checkbox"/>	<input type="checkbox"/>	<input type="checkbox"/>
NS06-4.750H7-EB30	10019458	4,75 0.1870	4,76 0.1875	4,75 0.1870	30,0 1.1810	6,0 0.2360	50,0 1.9690	4	<input type="checkbox"/>	<input type="checkbox"/>	<input checked="" type="checkbox"/>	<input checked="" type="checkbox"/>	<input type="checkbox"/>	<input type="checkbox"/>
NS06-4.762H7-EB...	-	4,762 0.1875	4,76 0.1875	4,77 0.1880	30,0 1.1810	6,0 0.2360	50,0 1.9690	4	<input type="checkbox"/>	<input type="checkbox"/>	<input type="checkbox"/>	<input type="checkbox"/>	<input type="checkbox"/>	<input type="checkbox"/>
NS06-4.97H7-EB...	-	4,97 0.1957	4,97 0.1957	4,98 0.1961	30,0 1.1810	6,0 0.2360	50,0 1.9690	4	<input type="checkbox"/>	<input type="checkbox"/>	<input type="checkbox"/>	<input type="checkbox"/>	<input type="checkbox"/>	<input type="checkbox"/>
NS06-4.98H7-EB...	-	4,98 0.1961	4,98 0.1961	4,99 0.1965	30,0 1.1810	6,0 0.2360	50,0 1.9690	4	<input type="checkbox"/>	<input type="checkbox"/>	<input type="checkbox"/>	<input type="checkbox"/>	<input type="checkbox"/>	<input type="checkbox"/>
NS06-4.99H7-EB...	-	4,99 0.1965	4,99 0.1965	5,00 0.1969	30,0 1.1810	6,0 0.2360	50,0 1.9690	4	<input type="checkbox"/>	<input type="checkbox"/>	<input type="checkbox"/>	<input type="checkbox"/>	<input type="checkbox"/>	<input type="checkbox"/>
NS06-5.00H7-EB...	-	5,0 0.1969	5,00 0.1969	5,01 0.1973	30,0 1.1810	6,0 0.2360	50,0 1.9690	4	<input type="checkbox"/>	<input type="checkbox"/>	<input type="checkbox"/>	<input type="checkbox"/>	<input type="checkbox"/>	<input type="checkbox"/>
NS06-5H7-EB30	10019459	5,0 0.1969	5,01 0.1973	5,00 0.1969	30,0 1.1810	6,0 0.2360	50,0 1.9690	4	<input type="checkbox"/>	<input type="checkbox"/>	<input checked="" type="checkbox"/>	<input checked="" type="checkbox"/>	<input type="checkbox"/>	<input type="checkbox"/>
NS06-5.01H7-EB...	-	5,01 0.1972	5,01 0.1972	5,02 0.1977	30,0 1.1810	6,0 0.2360	50,0 1.9690	4	<input type="checkbox"/>	<input type="checkbox"/>	<input type="checkbox"/>	<input type="checkbox"/>	<input type="checkbox"/>	<input type="checkbox"/>
NS06-5.02H7-EB...	-	5,02 0.1976	5,02 0.1976	5,03 0.1981	30,0 1.1810	6,0 0.2360	50,0 1.9690	4	<input type="checkbox"/>	<input type="checkbox"/>	<input type="checkbox"/>	<input type="checkbox"/>	<input type="checkbox"/>	<input type="checkbox"/>
NS06-5.03H7-EB...	-	5,03 0.1980	5,03 0.1980	5,04 0.1985	30,0 1.1810	6,0 0.2360	50,0 1.9690	4	<input type="checkbox"/>	<input type="checkbox"/>	<input type="checkbox"/>	<input type="checkbox"/>	<input type="checkbox"/>	<input type="checkbox"/>
NS06-5.04H7-EB...	-	5,04 0.1984	5,04 0.1984	5,05 0.1989	30,0 1.1810	6,0 0.2360	50,0 1.9690	4	<input type="checkbox"/>	<input type="checkbox"/>	<input type="checkbox"/>	<input type="checkbox"/>	<input type="checkbox"/>	<input type="checkbox"/>
NS06-5.05H7-EB...	-	5,05 0.1988	5,05 0.1988	5,06 0.1993	30,0 1.1810	6,0 0.2360	50,0 1.9690	4	<input type="checkbox"/>	<input type="checkbox"/>	<input type="checkbox"/>	<input type="checkbox"/>	<input type="checkbox"/>	<input type="checkbox"/>
NS06-5.50H7-EB...	-	5,5 0.2165	5,50 0.2165	5,51 0.2170	30,0 1.1810	6,0 0.2360	50,0 1.9690	4	<input type="checkbox"/>	<input type="checkbox"/>	<input type="checkbox"/>	<input type="checkbox"/>	<input type="checkbox"/>	<input type="checkbox"/>
NS06-5.97H7-EB...	-	5,97 0.2350	5,97 0.2350	5,98 0.2355	31,0 1.2200	6,0 0.2360	50,0 1.9690	4	<input type="checkbox"/>	<input type="checkbox"/>	<input type="checkbox"/>	<input type="checkbox"/>	<input type="checkbox"/>	<input type="checkbox"/>
NS06-5.98H7-EB...	-	5,98 0.2354	5,98 0.2354	5,99 0.2359	31,0 1.2200	6,0 0.2360	50,0 1.9690	4	<input type="checkbox"/>	<input type="checkbox"/>	<input type="checkbox"/>	<input type="checkbox"/>	<input type="checkbox"/>	<input type="checkbox"/>
NS06-5.99H7-EB...	-	5,99 0.2358	5,99 0.2358	6,00 0.2363	31,0 1.2200	6,0 0.2360	50,0 1.9690	4	<input type="checkbox"/>	<input type="checkbox"/>	<input type="checkbox"/>	<input type="checkbox"/>	<input type="checkbox"/>	<input type="checkbox"/>
NS06-6.00H7-EB...	-	6,0 0.2362	6,00 0.2362	6,01 0.2367	31,0 1.2200	6,0 0.2360	50,0 1.9690	4	<input type="checkbox"/>	<input type="checkbox"/>	<input type="checkbox"/>	<input type="checkbox"/>	<input type="checkbox"/>	<input type="checkbox"/>
NS06-6H7-EB30	10019460	6,0 0.2362	6,01 0.2367	6,00 0.2362	31,0 1.2200	6,0 0.2360	50,0 1.9690	4	<input type="checkbox"/>	<input type="checkbox"/>	<input checked="" type="checkbox"/>	<input checked="" type="checkbox"/>	<input type="checkbox"/>	<input type="checkbox"/>
NS06-6.01H7-EB...	-	6,01 0.2366	6,01 0.2366	6,03 0.2372	31,0 1.2200	6,0 0.2360	50,0 1.9690	4	<input type="checkbox"/>	<input type="checkbox"/>	<input type="checkbox"/>	<input type="checkbox"/>	<input type="checkbox"/>	<input type="checkbox"/>
NS06-6.02H7-EB...	-	6,02 0.2370	6,02 0.2370	6,04 0.2376	31,0 1.2200	6,0 0.2360	50,0 1.9690	4	<input type="checkbox"/>	<input type="checkbox"/>	<input type="checkbox"/>	<input type="checkbox"/>	<input type="checkbox"/>	<input type="checkbox"/>
NS06-6.03H7-EB...	-	6,03 0.2374	6,03 0.2374	6,05 0.2380	31,0 1.2200	6,0 0.2360	50,0 1.9690	4	<input type="checkbox"/>	<input type="checkbox"/>	<input type="checkbox"/>	<input type="checkbox"/>	<input type="checkbox"/>	<input type="checkbox"/>
NS06-6.04H7-EB...	-	6,04 0.2378	6,04 0.2378	6,06 0.2384	31,0 1.2200	6,0 0.2360	50,0 1.9690	4	<input type="checkbox"/>	<input type="checkbox"/>	<input type="checkbox"/>	<input type="checkbox"/>	<input type="checkbox"/>	<input type="checkbox"/>
NS06-6.05H7-EB...	-	6,05 0.2382	6,05 0.2382	6,07 0.2388	31,0 1.2200	6,0 0.2360	50,0 1.9690	4	<input type="checkbox"/>	<input type="checkbox"/>	<input type="checkbox"/>	<input type="checkbox"/>	<input type="checkbox"/>	<input type="checkbox"/>
NS10-6.334H7-EB...	-	6,334 0.2494	6,33 0.2494	6,35 0.2500	46,0 1.8110	10,0 0.3940	78,0 3.0710	6	<input type="checkbox"/>	<input type="checkbox"/>	<input type="checkbox"/>	<input type="checkbox"/>	<input type="checkbox"/>	<input type="checkbox"/>
NS10-6.334H7-EB30	10019461	6,334 0.2494	6,35 0.2500	6,33 0.2494	46,0 1.8110	10,0 0.3940	78,0 3.0710	4	<input type="checkbox"/>	<input type="checkbox"/>	<input checked="" type="checkbox"/>	<input checked="" type="checkbox"/>	<input type="checkbox"/>	<input type="checkbox"/>

Introduzione

Foratura

Alesatura

Barenatura

Allegato

	Codice di ordinazione	Codice prodotto	DC			Hole dia min-max			LUX	DMM	OAL	Geometrie			Qualità		
			mm Inch	mm Inch	mm Inch	mm Inch	mm Inch	mm Inch	mm Inch	mm Inch		EB45	EB845	EB30	RX2000	H15	H15
Introduzione	NS10-6.350H7-EB...	-	6,35 0.2500	6,35 0.2500	6,37 0.2506	46,0 1.8110	10,0 0.3940	78,0 3.0710	6	<input type="checkbox"/>	<input type="checkbox"/>	<input type="checkbox"/>	<input type="checkbox"/>	<input type="checkbox"/>	<input type="checkbox"/>	<input type="checkbox"/>	<input type="checkbox"/>
	NS10-6.375H7-EB...	-	6,375 0.2510	6,38 0.2510	6,39 0.2516	46,0 1.8110	10,0 0.3940	78,0 3.0710	6	<input type="checkbox"/>	<input type="checkbox"/>	<input type="checkbox"/>	<input type="checkbox"/>	<input type="checkbox"/>	<input type="checkbox"/>	<input type="checkbox"/>	<input type="checkbox"/>
	NS10-6.3754H7-EB30	10019462	6,375 0.2510	6,39 0.2516	6,38 0.2510	46,0 1.8110	10,0 0.3940	78,0 3.0710	4	<input type="checkbox"/>	<input type="checkbox"/>	<input checked="" type="checkbox"/>	<input checked="" type="checkbox"/>	<input type="checkbox"/>	<input type="checkbox"/>	<input type="checkbox"/>	
	NS10-6.5H7-EB...	-	6,5 0.2559	6,50 0.2559	6,52 0.2565	46,0 1.8110	10,0 0.3940	78,0 3.0710	6	<input type="checkbox"/>	<input type="checkbox"/>	<input type="checkbox"/>	<input type="checkbox"/>	<input type="checkbox"/>	<input type="checkbox"/>	<input type="checkbox"/>	
Foratura	NS10-6.97H7-EB...	-	6,97 0.2744	6,97 0.2744	6,99 0.2750	46,0 1.8110	10,0 0.3940	78,0 3.0710	6	<input type="checkbox"/>	<input type="checkbox"/>	<input type="checkbox"/>	<input type="checkbox"/>	<input type="checkbox"/>	<input type="checkbox"/>	<input type="checkbox"/>	
	NS10-6.98H7-EB...	-	6,98 0.2748	6,98 0.2748	7,00 0.2754	46,0 1.8110	10,0 0.3940	78,0 3.0710	6	<input type="checkbox"/>	<input type="checkbox"/>	<input type="checkbox"/>	<input type="checkbox"/>	<input type="checkbox"/>	<input type="checkbox"/>	<input type="checkbox"/>	
	NS10-6.99H7-EB...	-	6,99 0.2752	6,99 0.2752	7,01 0.2758	46,0 1.8110	10,0 0.3940	78,0 3.0710	6	<input type="checkbox"/>	<input type="checkbox"/>	<input type="checkbox"/>	<input type="checkbox"/>	<input type="checkbox"/>	<input type="checkbox"/>	<input type="checkbox"/>	
	NS10-7.00H7-EB...	-	7,0 0.2756	7,00 0.2756	7,02 0.2762	46,0 1.8110	10,0 0.3940	78,0 3.0710	6	<input type="checkbox"/>	<input type="checkbox"/>	<input type="checkbox"/>	<input type="checkbox"/>	<input type="checkbox"/>	<input type="checkbox"/>	<input type="checkbox"/>	
	NS10-7H7-EB30	10019463	7,0 0.2756	7,02 0.2762	7,00 0.2756	46,0 1.8110	10,0 0.3940	78,0 3.0710	4	<input type="checkbox"/>	<input type="checkbox"/>	<input checked="" type="checkbox"/>	<input checked="" type="checkbox"/>	<input type="checkbox"/>	<input type="checkbox"/>	<input type="checkbox"/>	
	NS10-7.01H7-EB...	-	7,01 0.2760	7,01 0.2760	7,03 0.2766	46,0 1.8110	10,0 0.3940	78,0 3.0710	6	<input type="checkbox"/>	<input type="checkbox"/>	<input type="checkbox"/>	<input type="checkbox"/>	<input type="checkbox"/>	<input type="checkbox"/>	<input type="checkbox"/>	<input type="checkbox"/>
	NS10-7.02H7-EB...	-	7,02 0.2764	7,02 0.2764	7,04 0.2770	46,0 1.8110	10,0 0.3940	78,0 3.0710	6	<input type="checkbox"/>	<input type="checkbox"/>	<input type="checkbox"/>	<input type="checkbox"/>	<input type="checkbox"/>	<input type="checkbox"/>	<input type="checkbox"/>	<input type="checkbox"/>
	NS10-7.03H7-EB...	-	7,03 0.2768	7,03 0.2768	7,05 0.2774	46,0 1.8110	10,0 0.3940	78,0 3.0710	6	<input type="checkbox"/>	<input type="checkbox"/>	<input type="checkbox"/>	<input type="checkbox"/>	<input type="checkbox"/>	<input type="checkbox"/>	<input type="checkbox"/>	<input type="checkbox"/>
	NS10-7.04H7-EB...	-	7,04 0.2772	7,04 0.2772	7,06 0.2778	46,0 1.8110	10,0 0.3940	78,0 3.0710	6	<input type="checkbox"/>	<input type="checkbox"/>	<input type="checkbox"/>	<input type="checkbox"/>	<input type="checkbox"/>	<input type="checkbox"/>	<input type="checkbox"/>	<input type="checkbox"/>
	NS10-7.05H7-EB...	-	7,05 0.2776	7,05 0.2776	7,07 0.2781	46,0 1.8110	10,0 0.3940	78,0 3.0710	6	<input type="checkbox"/>	<input type="checkbox"/>	<input type="checkbox"/>	<input type="checkbox"/>	<input type="checkbox"/>	<input type="checkbox"/>	<input type="checkbox"/>	<input type="checkbox"/>
Alesatura	NS10-7.50H7-EB...	-	7,5 0.2953	7,50 0.2953	7,52 0.2959	46,0 1.8110	10,0 0.3940	78,0 3.0710	6	<input type="checkbox"/>	<input type="checkbox"/>	<input type="checkbox"/>	<input type="checkbox"/>	<input type="checkbox"/>	<input type="checkbox"/>	<input type="checkbox"/>	
	NS10-7.9375H7-EB...	-	7,9375 0.3125	7,94 0.3125	7,95 0.3131	46,0 1.8110	10,0 0.3940	78,0 3.0710	6	<input type="checkbox"/>	<input type="checkbox"/>	<input type="checkbox"/>	<input type="checkbox"/>	<input type="checkbox"/>	<input type="checkbox"/>	<input type="checkbox"/>	
	NS10-7.97H7-EB...	-	7,97 0.3138	7,97 0.3138	7,99 0.3144	46,0 1.8110	10,0 0.3940	78,0 3.0710	6	<input type="checkbox"/>	<input type="checkbox"/>	<input type="checkbox"/>	<input type="checkbox"/>	<input type="checkbox"/>	<input type="checkbox"/>	<input type="checkbox"/>	
	NS10-7.98H7-EB...	-	7,98 0.3142	7,98 0.3142	8,00 0.3148	46,0 1.8110	10,0 0.3940	78,0 3.0710	6	<input type="checkbox"/>	<input type="checkbox"/>	<input type="checkbox"/>	<input type="checkbox"/>	<input type="checkbox"/>	<input type="checkbox"/>	<input type="checkbox"/>	
	NS10-7.99H7-EB...	-	7,99 0.3146	7,99 0.3146	8,01 0.3152	46,0 1.8110	10,0 0.3940	78,0 3.0710	6	<input type="checkbox"/>	<input type="checkbox"/>	<input type="checkbox"/>	<input type="checkbox"/>	<input type="checkbox"/>	<input type="checkbox"/>	<input type="checkbox"/>	
	NS10-8.00H7-EB...	-	8,0 0.3150	8,00 0.3150	8,02 0.3156	46,0 1.8110	10,0 0.3940	78,0 3.0710	6	<input type="checkbox"/>	<input type="checkbox"/>	<input type="checkbox"/>	<input type="checkbox"/>	<input type="checkbox"/>	<input type="checkbox"/>	<input type="checkbox"/>	
	NS10-8H7-EB30	10019464	8,0 0.3150	8,02 0.3156	8,00 0.3150	46,0 1.8110	10,0 0.3940	78,0 3.0710	4	<input type="checkbox"/>	<input type="checkbox"/>	<input checked="" type="checkbox"/>	<input checked="" type="checkbox"/>	<input type="checkbox"/>	<input type="checkbox"/>	<input type="checkbox"/>	
	NS10-8.01H7-EB...	-	8,01 0.3154	8,01 0.3154	8,03 0.3159	46,0 1.8110	10,0 0.3940	78,0 3.0710	6	<input type="checkbox"/>	<input type="checkbox"/>	<input type="checkbox"/>	<input type="checkbox"/>	<input type="checkbox"/>	<input type="checkbox"/>	<input type="checkbox"/>	
	NS10-8.02H7-EB...	-	8,02 0.3157	8,02 0.3157	8,04 0.3163	46,0 1.8110	10,0 0.3940	78,0 3.0710	6	<input type="checkbox"/>	<input type="checkbox"/>	<input type="checkbox"/>	<input type="checkbox"/>	<input type="checkbox"/>	<input type="checkbox"/>	<input type="checkbox"/>	
	NS10-8.03H7-EB...	-	8,03 0.3161	8,03 0.3161	8,05 0.3167	46,0 1.8110	10,0 0.3940	78,0 3.0710	6	<input type="checkbox"/>	<input type="checkbox"/>	<input type="checkbox"/>	<input type="checkbox"/>	<input type="checkbox"/>	<input type="checkbox"/>	<input type="checkbox"/>	
Barenatura	NS10-8.04H7-EB...	-	8,04 0.3165	8,04 0.3165	8,06 0.3171	46,0 1.8110	10,0 0.3940	78,0 3.0710	6	<input type="checkbox"/>	<input type="checkbox"/>	<input type="checkbox"/>	<input type="checkbox"/>	<input type="checkbox"/>	<input type="checkbox"/>	<input type="checkbox"/>	
	NS10-8.05H7-EB...	-	8,05 0.3169	8,05 0.3169	8,07 0.3175	46,0 1.8110	10,0 0.3940	78,0 3.0710	6	<input type="checkbox"/>	<input type="checkbox"/>	<input type="checkbox"/>	<input type="checkbox"/>	<input type="checkbox"/>	<input type="checkbox"/>	<input type="checkbox"/>	
	NS10-8.50H7-EB...	-	8,5 0.3346	8,50 0.3346	8,52 0.3352	46,0 1.8110	10,0 0.3940	78,0 3.0710	6	<input type="checkbox"/>	<input type="checkbox"/>	<input type="checkbox"/>	<input type="checkbox"/>	<input type="checkbox"/>	<input type="checkbox"/>	<input type="checkbox"/>	
	NS10-8.97H7-EB...	-	8,97 0.3531	8,97 0.3531	8,99 0.3537	46,0 1.8110	10,0 0.3940	78,0 3.0710	6	<input type="checkbox"/>	<input type="checkbox"/>	<input type="checkbox"/>	<input type="checkbox"/>	<input type="checkbox"/>	<input type="checkbox"/>	<input type="checkbox"/>	
	NS10-8.98H7-EB...	-	8,98 0.3535	8,98 0.3535	9,00 0.3541	46,0 1.8110	10,0 0.3940	78,0 3.0710	6	<input type="checkbox"/>	<input type="checkbox"/>	<input type="checkbox"/>	<input type="checkbox"/>	<input type="checkbox"/>	<input type="checkbox"/>	<input type="checkbox"/>	
	NS10-8.99H7-EB...	-	8,99 0.3539	8,99 0.3539	9,01 0.3545	46,0 1.8110	10,0 0.3940	78,0 3.0710	6	<input type="checkbox"/>	<input type="checkbox"/>	<input type="checkbox"/>	<input type="checkbox"/>	<input type="checkbox"/>	<input type="checkbox"/>	<input type="checkbox"/>	
	Allegato																

Codice di ordinazione	Codice prodotto	DC	Hole dia min-max		LUX	DMM	OAL		Geometrie			Qualità			
			mm Inch	mm Inch					mm Inch	mm Inch	mm Inch	mm Inch	mm Inch	mm Inch	EB45
NS10-9.00H7-EB...	-	9,0 0.3543	9,00 0.3543	9,02 0.3549	46,0 1.8110	10,0 0.3940	78,0 3.0710	6	<input type="checkbox"/>	<input type="checkbox"/>	<input type="checkbox"/>	<input type="checkbox"/>	<input type="checkbox"/>	<input type="checkbox"/>	<input type="checkbox"/>
NS10-9H7-EB30	10019465	9,0 0.3543	9,02 0.3549	9,00 0.3543	46,0 1.8110	10,0 0.3940	78,0 3.0710	4	<input type="checkbox"/>	<input type="checkbox"/>	<input checked="" type="checkbox"/>	<input checked="" type="checkbox"/>	<input type="checkbox"/>	<input type="checkbox"/>	
NS10-9.01H7-EB...	-	9,01 0.3547	9,01 0.3547	9,03 0.3553	46,0 1.8110	10,0 0.3940	78,0 3.0710	6	<input type="checkbox"/>	<input type="checkbox"/>	<input type="checkbox"/>	<input type="checkbox"/>	<input type="checkbox"/>	<input type="checkbox"/>	
NS10-9.02H7-EB...	-	9,02 0.3551	9,02 0.3551	9,04 0.3557	46,0 1.8110	10,0 0.3940	78,0 3.0710	6	<input type="checkbox"/>	<input type="checkbox"/>	<input type="checkbox"/>	<input type="checkbox"/>	<input type="checkbox"/>	<input type="checkbox"/>	
NS10-9.03H7-EB...	-	9,03 0.3555	9,03 0.3555	9,05 0.3561	46,0 1.8110	10,0 0.3940	78,0 3.0710	6	<input type="checkbox"/>	<input type="checkbox"/>	<input type="checkbox"/>	<input type="checkbox"/>	<input type="checkbox"/>	<input type="checkbox"/>	
NS10-9.04H7-EB...	-	9,04 0.3559	9,04 0.3559	9,06 0.3565	46,0 1.8110	10,0 0.3940	78,0 3.0710	6	<input type="checkbox"/>	<input type="checkbox"/>	<input type="checkbox"/>	<input type="checkbox"/>	<input type="checkbox"/>	<input type="checkbox"/>	
NS10-9.05H7-EB...	-	9,05 0.3563	9,05 0.3563	9,07 0.3569	46,0 1.8110	10,0 0.3940	78,0 3.0710	6	<input type="checkbox"/>	<input type="checkbox"/>	<input type="checkbox"/>	<input type="checkbox"/>	<input type="checkbox"/>	<input type="checkbox"/>	
NS10-9.50H7-EB...	-	9,5 0.3740	9,50 0.3740	9,52 0.3746	46,0 1.8110	10,0 0.3940	78,0 3.0710	6	<input type="checkbox"/>	<input type="checkbox"/>	<input type="checkbox"/>	<input type="checkbox"/>	<input type="checkbox"/>	<input type="checkbox"/>	
NS10-9.5123H7-EB...	-	9,5123 0.3745	9,51 0.3745	9,53 0.3751	46,0 1.8110	10,0 0.3940	78,0 3.0710	6	<input type="checkbox"/>	<input type="checkbox"/>	<input type="checkbox"/>	<input type="checkbox"/>	<input type="checkbox"/>	<input type="checkbox"/>	
NS10-9.5250H7-EB...	-	9,525 0.3750	9,53 0.3750	9,54 0.3756	46,0 1.8110	10,0 0.3940	78,0 3.0710	6	<input type="checkbox"/>	<input type="checkbox"/>	<input type="checkbox"/>	<input type="checkbox"/>	<input type="checkbox"/>	<input type="checkbox"/>	
NS10-9.525H7-EB30	10019466	9,525 0.3750	9,54 0.3756	9,53 0.3750	46,0 1.8110	10,0 0.3940	78,0 3.0710	4	<input type="checkbox"/>	<input type="checkbox"/>	<input checked="" type="checkbox"/>	<input checked="" type="checkbox"/>	<input type="checkbox"/>	<input type="checkbox"/>	
NS10-9.97H7-EB...	-	9,97 0.3925	9,97 0.3925	9,99 0.3931	46,0 1.8110	10,0 0.3940	78,0 3.0710	6	<input type="checkbox"/>	<input type="checkbox"/>	<input type="checkbox"/>	<input type="checkbox"/>	<input type="checkbox"/>	<input type="checkbox"/>	
NS10-9.98H7-EB...	-	9,98 0.3929	9,98 0.3929	10,00 0.3935	46,0 1.8110	10,0 0.3940	78,0 3.0710	6	<input type="checkbox"/>	<input type="checkbox"/>	<input type="checkbox"/>	<input type="checkbox"/>	<input type="checkbox"/>	<input type="checkbox"/>	
NS10-9.99H7-EB...	-	9,99 0.3933	9,99 0.3933	10,01 0.3939	46,0 1.8110	10,0 0.3940	78,0 3.0710	6	<input type="checkbox"/>	<input type="checkbox"/>	<input type="checkbox"/>	<input type="checkbox"/>	<input type="checkbox"/>	<input type="checkbox"/>	
NS10-10.00H7-EB...	-	10,0 0.3937	10,00 0.3937	10,02 0.3943	46,0 1.8110	10,0 0.3940	78,0 3.0710	6	<input type="checkbox"/>	<input type="checkbox"/>	<input type="checkbox"/>	<input type="checkbox"/>	<input type="checkbox"/>	<input type="checkbox"/>	
NS10-10H7-EB30	10019467	10,0 0.3937	10,02 0.3943	10,00 0.3937	46,0 1.8110	10,0 0.3940	78,0 3.0710	4	<input type="checkbox"/>	<input type="checkbox"/>	<input checked="" type="checkbox"/>	<input checked="" type="checkbox"/>	<input type="checkbox"/>	<input type="checkbox"/>	
NS10-10.01H7-EB...	-	10,01 0.3941	10,01 0.3941	10,03 0.3948	46,0 1.8110	10,0 0.3940	78,0 3.0710	6	<input type="checkbox"/>	<input type="checkbox"/>	<input type="checkbox"/>	<input type="checkbox"/>	<input type="checkbox"/>	<input type="checkbox"/>	
NS10-10.02H7-EB...	-	10,02 0.3945	10,02 0.3945	10,04 0.3952	46,0 1.8110	10,0 0.3940	78,0 3.0710	6	<input type="checkbox"/>	<input type="checkbox"/>	<input type="checkbox"/>	<input type="checkbox"/>	<input type="checkbox"/>	<input type="checkbox"/>	
NS10-10.03H7-EB...	-	10,03 0.3949	10,03 0.3949	10,05 0.3956	46,0 1.8110	10,0 0.3940	78,0 3.0710	6	<input type="checkbox"/>	<input type="checkbox"/>	<input type="checkbox"/>	<input type="checkbox"/>	<input type="checkbox"/>	<input type="checkbox"/>	
NS10-10.04H7-EB...	-	10,04 0.3953	10,04 0.3953	10,06 0.3960	46,0 1.8110	10,0 0.3940	78,0 3.0710	6	<input type="checkbox"/>	<input type="checkbox"/>	<input type="checkbox"/>	<input type="checkbox"/>	<input type="checkbox"/>	<input type="checkbox"/>	
NS10-10.05H7-EB...	-	10,05 0.3957	10,05 0.3957	10,07 0.3964	46,0 1.8110	10,0 0.3940	78,0 3.0710	6	<input type="checkbox"/>	<input type="checkbox"/>	<input type="checkbox"/>	<input type="checkbox"/>	<input type="checkbox"/>	<input type="checkbox"/>	
NS10-10.50H7-EB...	-	10,5 0.4134	10,50 0.4134	10,52 0.4141	57,0 2.2440	10,0 0.3940	88,0 3.4650	6	<input type="checkbox"/>	<input type="checkbox"/>	<input type="checkbox"/>	<input type="checkbox"/>	<input type="checkbox"/>	<input type="checkbox"/>	
NS10-10.97H7-EB...	-	10,97 0.4319	10,97 0.4319	10,99 0.4326	57,0 2.2440	10,0 0.3940	88,0 3.4650	6	<input type="checkbox"/>	<input type="checkbox"/>	<input type="checkbox"/>	<input type="checkbox"/>	<input type="checkbox"/>	<input type="checkbox"/>	
NS10-10.98H7-EB...	-	10,98 0.4323	10,98 0.4323	11,00 0.4330	57,0 2.2440	10,0 0.3940	88,0 3.4650	6	<input type="checkbox"/>	<input type="checkbox"/>	<input type="checkbox"/>	<input type="checkbox"/>	<input type="checkbox"/>	<input type="checkbox"/>	
NS10-10.99H7-EB...	-	10,99 0.4327	10,99 0.4327	11,01 0.4334	57,0 2.2440	10,0 0.3940	88,0 3.4650	6	<input type="checkbox"/>	<input type="checkbox"/>	<input type="checkbox"/>	<input type="checkbox"/>	<input type="checkbox"/>	<input type="checkbox"/>	
NS10-11.00H7-EB...	-	11,0 0.4331	11,00 0.4331	11,02 0.4338	57,0 2.2440	10,0 0.3940	88,0 3.4650	6	<input type="checkbox"/>	<input type="checkbox"/>	<input type="checkbox"/>	<input type="checkbox"/>	<input type="checkbox"/>	<input type="checkbox"/>	
NS10-11.01H7-EB...	-	11,01 0.4335	11,01 0.4335	11,03 0.4342	57,0 2.2440	10,0 0.3940	88,0 3.4650	6	<input type="checkbox"/>	<input type="checkbox"/>	<input type="checkbox"/>	<input type="checkbox"/>	<input type="checkbox"/>	<input type="checkbox"/>	
NS10-11.02H7-EB...	-	11,02 0.4339	11,02 0.4339	11,04 0.4346	57,0 2.2440	10,0 0.3940	88,0 3.4650	6	<input type="checkbox"/>	<input type="checkbox"/>	<input type="checkbox"/>	<input type="checkbox"/>	<input type="checkbox"/>	<input type="checkbox"/>	
NS10-11.03H7-EB...	-	11,03 0.4343	11,03 0.4343	11,05 0.4350	57,0 2.2440	10,0 0.3940	88,0 3.4650	6	<input type="checkbox"/>	<input type="checkbox"/>	<input type="checkbox"/>	<input type="checkbox"/>	<input type="checkbox"/>	<input type="checkbox"/>	
NS10-11.04H7-EB...	-	11,04 0.4346	11,04 0.4346	11,06 0.4354	57,0 2.2440	10,0 0.3940	88,0 3.4650	6	<input type="checkbox"/>	<input type="checkbox"/>	<input type="checkbox"/>	<input type="checkbox"/>	<input type="checkbox"/>	<input type="checkbox"/>	

Introduzione

Foratura

Alesatura

Barenatura

Allegato

	Codice di ordinazione	Codice prodotto	DC			Hole dia min-max			LUX	DMM	OAL	Geometrie			Qualità		
			mm Inch	mm Inch	mm Inch	mm Inch	mm Inch	mm Inch	mm Inch	mm Inch	mm Inch	mm Inch	mm Inch	mm Inch	mm Inch	mm Inch	mm Inch
Introduzione	NS10-11.05H7-EB...	-	11,05 0.4350	11,05 0.4350	11,07 0.4357	57,0 2.2440	10,0 0.3940	88,0 3.4650	6	<input type="checkbox"/>	<input type="checkbox"/>	<input type="checkbox"/>	<input type="checkbox"/>	<input type="checkbox"/>	<input type="checkbox"/>	<input type="checkbox"/>	<input type="checkbox"/>
	NS10-11.112H7-EB...	-	11,112 0.4375	11,11 0.4375	11,13 0.4382	57,0 2.2440	10,0 0.3940	88,0 3.4650	6	<input type="checkbox"/>	<input type="checkbox"/>	<input type="checkbox"/>	<input type="checkbox"/>	<input type="checkbox"/>	<input type="checkbox"/>	<input type="checkbox"/>	<input type="checkbox"/>
	NS10-11.50H7-EB...	-	11,5 0.4528	11,50 0.4528	11,52 0.4535	57,0 2.2440	10,0 0.3940	88,0 3.4650	6	<input type="checkbox"/>	<input type="checkbox"/>	<input type="checkbox"/>	<input type="checkbox"/>	<input type="checkbox"/>	<input type="checkbox"/>	<input type="checkbox"/>	<input type="checkbox"/>
	NS10-11.97H7-EB...	-	11,97 0.4713	11,97 0.4713	11,99 0.4720	57,0 2.2440	10,0 0.3940	88,0 3.4650	6	<input type="checkbox"/>	<input type="checkbox"/>	<input type="checkbox"/>	<input type="checkbox"/>	<input type="checkbox"/>	<input type="checkbox"/>	<input type="checkbox"/>	<input type="checkbox"/>
Foratura	NS10-11.98H7-EB...	-	11,98 0.4717	11,98 0.4717	12,00 0.4724	57,0 2.2440	10,0 0.3940	88,0 3.4650	6	<input type="checkbox"/>	<input type="checkbox"/>	<input type="checkbox"/>	<input type="checkbox"/>	<input type="checkbox"/>	<input type="checkbox"/>	<input type="checkbox"/>	<input type="checkbox"/>
	NS10-11.99H7-EB...	-	11,99 0.4720	11,99 0.4720	12,01 0.4728	57,0 2.2440	10,0 0.3940	88,0 3.4650	6	<input type="checkbox"/>	<input type="checkbox"/>	<input type="checkbox"/>	<input type="checkbox"/>	<input type="checkbox"/>	<input type="checkbox"/>	<input type="checkbox"/>	<input type="checkbox"/>
	NS10-12.00H7-EB...	-	12,0 0.4724	12,00 0.4724	12,02 0.4731	57,0 2.2440	10,0 0.3940	88,0 3.4650	6	<input type="checkbox"/>	<input type="checkbox"/>	<input type="checkbox"/>	<input type="checkbox"/>	<input type="checkbox"/>	<input type="checkbox"/>	<input type="checkbox"/>	<input type="checkbox"/>
	NS10-12H7-EB30	10019468	12,0 0.4724	12,02 0.4731	12,00 0.4724	57,0 2.2440	10,0 0.3940	88,0 3.4650	4	<input type="checkbox"/>	<input type="checkbox"/>	<input checked="" type="checkbox"/>	<input checked="" type="checkbox"/>	<input type="checkbox"/>	<input type="checkbox"/>	<input type="checkbox"/>	<input type="checkbox"/>
	NS10-12.01H7-EB...	-	12,01 0.4728	12,01 0.4728	12,03 0.4735	57,0 2.2440	10,0 0.3940	88,0 3.4650	6	<input type="checkbox"/>	<input type="checkbox"/>	<input type="checkbox"/>	<input type="checkbox"/>	<input type="checkbox"/>	<input type="checkbox"/>	<input type="checkbox"/>	<input type="checkbox"/>
	NS10-12.02H7-EB...	-	12,02 0.4732	12,02 0.4732	12,04 0.4739	57,0 2.2440	10,0 0.3940	88,0 3.4650	6	<input type="checkbox"/>	<input type="checkbox"/>	<input type="checkbox"/>	<input type="checkbox"/>	<input type="checkbox"/>	<input type="checkbox"/>	<input type="checkbox"/>	<input type="checkbox"/>
	NS10-12.03H7-EB...	-	12,03 0.4736	12,03 0.4736	12,05 0.4743	57,0 2.2440	10,0 0.3940	88,0 3.4650	6	<input type="checkbox"/>	<input type="checkbox"/>	<input type="checkbox"/>	<input type="checkbox"/>	<input type="checkbox"/>	<input type="checkbox"/>	<input type="checkbox"/>	<input type="checkbox"/>
	NS10-12.04H7-EB...	-	12,04 0.4740	12,04 0.4740	12,06 0.4747	57,0 2.2440	10,0 0.3940	88,0 3.4650	6	<input type="checkbox"/>	<input type="checkbox"/>	<input type="checkbox"/>	<input type="checkbox"/>	<input type="checkbox"/>	<input type="checkbox"/>	<input type="checkbox"/>	<input type="checkbox"/>
NS10-12.05H7-EB...	-	12,05 0.4744	12,05 0.4744	12,07 0.4751	57,0 2.2440	10,0 0.3940	88,0 3.4650	6	<input type="checkbox"/>	<input type="checkbox"/>	<input type="checkbox"/>	<input type="checkbox"/>	<input type="checkbox"/>	<input type="checkbox"/>	<input type="checkbox"/>	<input type="checkbox"/>	

■ Prodotto standard a stock □ Prodotto standard non a stock.

Nota: Quando si ordinano alesatori Nanofix per diametri intermedi, indicare il diametro e la tolleranza del foro da alesare.

Esempio d'ordine: NS10-10.187/10.213-EB845, RX2000.

Introduzione

Foratura

Alesatura

Barenatura

Allegato

Diametro intermedio

Scanalature diritte, versione lunga, per fori passanti e ciechi

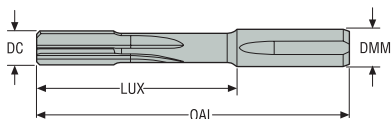

- Per la scelta della geometria, vedere le pagine 374-376
- Per i parametri di taglio raccomandati, vedere pagina(e) 393-400

Codice di ordinazione	DCN	DCX	LUX	DMM	OAL	Dimensione stelo	Geometrie	Qualità							
	mm Inch	mm Inch	mm Inch	mm Inch	mm Inch				H15	RK2050	RX2000	RN2010	RM2020	RM2090	RS2090
NS06-2.970-XX-XXXX	2,97 0.117	3,05 0.120	25,0 0.120	6,0 0.236	45,0 1.772	4	NFQF06-xx	EB45 EB845 EB30	<input type="checkbox"/>	<input type="checkbox"/>	<input type="checkbox"/>	<input type="checkbox"/>	<input type="checkbox"/>	<input type="checkbox"/>	<input type="checkbox"/>
NS06-3.051-XX-XXXX	3,051 0.120	6,05 0.238	30,0 0.238	6,0 0.236	50,0 1.969	4	NFQF06-xx	EB45 EB845 EB30	<input type="checkbox"/>	<input type="checkbox"/>	<input type="checkbox"/>	<input type="checkbox"/>	<input type="checkbox"/>	<input type="checkbox"/>	<input type="checkbox"/>
NS10-6.051-XX-XXXX	6,051 0.238	10,05 0.396	46,0 0.396	10,0 0.394	78,0 3.071	6	NFQF10-xx	EB45 EB845 EB30	<input type="checkbox"/>	<input type="checkbox"/>	<input type="checkbox"/>	<input type="checkbox"/>	<input type="checkbox"/>	<input type="checkbox"/>	<input type="checkbox"/>
NS10-10.051-XX-XXXX	10,051 0.396	12,05 0.474	57,0 0.474	10,0 0.394	88,0 3.465	6	NFQF10-xx	EB45 EB845 EB30	<input type="checkbox"/>	<input type="checkbox"/>	<input type="checkbox"/>	<input type="checkbox"/>	<input type="checkbox"/>	<input type="checkbox"/>	<input type="checkbox"/>

= Prodotto standard non presente a magazzino

Nota: Quando si ordinano alesatori Nanofix per diametri intermedi, indicare il diametro e la tolleranza del foro da alesare.

Esempio d'ordine: NS06-5.187/5.213-EB845, RX2000.

Diametro intermedio

Scanalature elicoidali SX, versione corta, per fori passanti

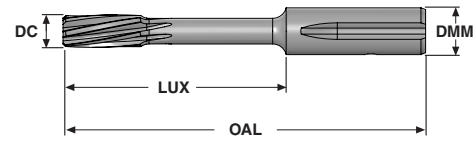

- Per la scelta della geometria, vedere le pagine 374-376
- Per i parametri di taglio raccomandati, vedere pagina(e) 393-400

Codice di ordinazione	DCN	DCX	LUX	DMM	OAL	Dimensione stelo	Geometrie	Qualità							
	mm Inch	mm Inch	mm Inch	mm Inch	mm Inch				H15	RK2050	RX2000	RN2010	RM2020	RM2090	RS2090
NS6-2.970-XX-XXXX	2,97 0.117	3,05 0.120	25,0 0.984	6,0 0.236	45,0 1.772	4	NFQF06-xx	EB45 EB845 EB30	<input type="checkbox"/>	<input type="checkbox"/>	<input type="checkbox"/>	<input type="checkbox"/>	<input type="checkbox"/>	<input type="checkbox"/>	<input type="checkbox"/>
NS6-3.051-XX-XXXX	3,051 0.120	6,05 0.238	30,0 1.181	6,0 0.236	50,0 1.969	4	NFQF06-xx	EB45 EB845 EB30	<input type="checkbox"/>	<input type="checkbox"/>	<input type="checkbox"/>	<input type="checkbox"/>	<input type="checkbox"/>	<input type="checkbox"/>	<input type="checkbox"/>
NS6-6.051-XX-XXXX	6,051 0.238	8,05 0.317	46,0 1.811	10,0 0.394	78,0 3.071	6	NFQF10-xx	EB45 EB845 EB30	<input type="checkbox"/>	<input type="checkbox"/>	<input type="checkbox"/>	<input type="checkbox"/>	<input type="checkbox"/>	<input type="checkbox"/>	<input type="checkbox"/>
NS6-10.051-XX-XXXX	10,051 0.396	12,05 0.474	57,0 2.244	10,0 0.394	88,0 3.465	6	NFQF10-xx	EB45 EB845 EB30	<input type="checkbox"/>	<input type="checkbox"/>	<input type="checkbox"/>	<input type="checkbox"/>	<input type="checkbox"/>	<input type="checkbox"/>	<input type="checkbox"/>

= Prodotto standard non presente a magazzino

Nota: Quando si ordinano alesatori Nanofix per diametri intermedi, indicare il diametro e la tolleranza del foro da alesare.

Esempio d'ordine: NS6-5.187/5.213-EB845, RX2000.

Introduzione

Foratura

Alesatura

Barenatura

Allegato

Diametro intermedio

Scanalature elicoidali DX, versione lunga, per fori ciechi

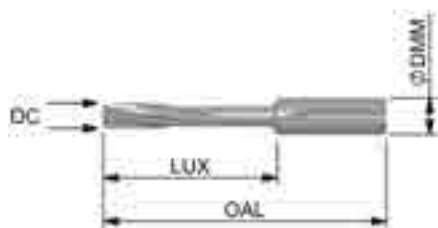

- Per la scelta della geometria, vedere le pagine 374-376
- Per i parametri di taglio raccomandati, vedere pagina(e) 393-400

Codice di ordinazione	DCN	DCX	LUX	DMM	OAL	Dimensione stelo	Geometrie	Qualità							
	mm Inch	mm Inch	mm Inch	mm Inch	mm Inch				H15	RK2050	RX2000	RN2010	RM2020	RM2090	RS2090
NS4-2.970-XX-XXXX	2,97 0.117	3,05 0.120	25,0 0.984	6,0 0.236	45,0 1.772	4	NFQF06-xx	EB45 EB845	<input type="checkbox"/>	<input type="checkbox"/>	<input type="checkbox"/>	<input type="checkbox"/>	<input type="checkbox"/>	<input type="checkbox"/>	<input type="checkbox"/>
NS4-3.051-XX-XXXX	3,051 0.120	6,05 0.238	30,0 1.181	6,0 0.236	50,0 1.969	4	NFQF06-xx	EB45 EB845	<input type="checkbox"/>	<input type="checkbox"/>	<input type="checkbox"/>	<input type="checkbox"/>	<input type="checkbox"/>	<input type="checkbox"/>	<input type="checkbox"/>
NS4-4.051-XX-XXXX	6,051 0.238	8,05 0.317	46,0 1.811	10,0 0.394	78,0 3.071	6	NFQF10-xx	EB45 EB845	<input type="checkbox"/>	<input type="checkbox"/>	<input type="checkbox"/>	<input type="checkbox"/>	<input type="checkbox"/>	<input type="checkbox"/>	<input type="checkbox"/>
NS4-10.051-XX-XXXX	10,051 0.396	12,05 0.474	57,0 2.244	10,0 0.394	88,0 3.465	6	NFQF10-xx	EB45 EB845	<input type="checkbox"/>	<input type="checkbox"/>	<input type="checkbox"/>	<input type="checkbox"/>	<input type="checkbox"/>	<input type="checkbox"/>	<input type="checkbox"/>

= Prodotto standard non presente a magazzino

Nota: Quando si ordinano alesatori Nanofix per diametri intermedi, indicare il diametro e la tolleranza del foro da alesare.

Esempio d'ordine: NS4-10.187/10.213-EB845, RX2000.

Portautensili Nanofix

Introduzione

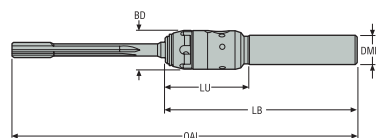

Foratura

Codice di ordinazione	Codice prodotto	DC	DMM	BD	LU	LB
		mm	mm	mm	mm	mm
NFQF06-03700-10N1	02729036	2,97-6,05	10,0	16,0	37,0	80,0
NFQF06-03300-12N1	02729037	2,97-6,05	12,0	16,0	35,0	80,0
NFQF06-03000-16N1	02729041	2,97-6,05	16,0	16,0	30,0	80,0
NFQF10-05200-12N1	02729044	6,051-12,05	12,0	23,0	52,0	100,0
NFQF10-04900-16N1	02729045	6,051-12,05	16,0	23,0	49,0	100,0
NFQF10-04700-20N1	02729046	6,051-12,05	20,0	23,0	47,0	100,0

Alesatura

	Lunghezza standard	Versione corta
DC	OAL	OAL
2,970-3,050 mm (0.1169-0.1200")	124,5 mm (4.902")	109,5 mm (4.311")
3,051-6,050 mm (0.1201-0.2382")	144,5 mm (5.689")	113,5 mm (4.469")
6,051-8,050 mm (0.2383-0.3169")	189,5 mm (7.461")	149,5 mm (5.886")
8,051-10,050 mm (0.3170-0.3956")	199,5 mm (7.854")	152,5 mm (6.004")
10,051-12,050 mm (0.3957-0.4744")	219,5 mm (8.642")	162,5 mm (6.398")

Parti di ricambio, comprese nella fornitura

Barenatura

DC	Kit di serraggio di ricambio	Chiave
2,97-6,050	NF06-CLKI	CLC06KEY
6,051-12,050	NF10-CLKI	CLC10KEY

Il kit di serraggio di ricambio per attacchi Nanofix include quanto segue:

- 1 ghiera di serraggio
- 1 anello elastico di fermo assiale
- 3 sfere di serraggio (diam. 3,5 mm per misura NF06 e diam. 5 mm per misura NF10)
- 1 sfera di bloccaggio non estraibile (diam. 3 mm per misura NF06 e diam. 4 mm per misura NF10)
- 1 O-ring

Nota: sfera di bloccaggio non estraibile non mostrata in figura.

Allegato

Parametri di taglio – NF/NS...-EB45 misure metriche

SMG		a _p (°)		f		v _c							
		z=4	z=6	z=4	z=6	H15	CP20	RX2000	RK2050	RN2010	RM2020	RM2090	RS2090
P1	NF/NS-EB45	0,10-0,15	0,1-0,20	0,10-0,30	0,20-0,60	25 (15-30)	60 (30-100)	80 (30-150)	-	-	-	-	-
P2	NF/NS-EB45	0,10-0,15	0,1-0,20	0,10-0,30	0,20-0,60	25 (15-30)	60 (30-100)	80 (30-150)	-	-	-	-	-
P3	NF/NS-EB45	0,10-0,15	0,1-0,20	0,10-0,30	0,20-0,60	25 (15-30)	60 (30-100)	80 (30-150)	-	-	-	-	-
P4	NF/NS-EB45	0,10-0,15	0,1-0,20	0,10-0,20	0,20-0,50	20 (10-25)	50 (30-80)	60 (30-120)	-	-	-	-	-
P5	NF/NS-EB45	0,10-0,15	0,1-0,20	0,10-0,20	0,20-0,50	20 (10-25)	50 (30-80)	60 (30-120)	-	-	-	-	-
P6	NF/NS-EB45	0,10-0,15	0,1-0,20	0,10-0,20	0,20-0,50	20 (10-25)	50 (30-80)	60 (30-120)	-	-	-	-	-
P7	NF/NS-EB45	0,10-0,15	0,1-0,20	0,10-0,20	0,20-0,50	20 (10-25)	50 (30-80)	60 (30-120)	-	-	-	-	-
P8	NF/NS-EB45	0,10-0,15	0,1-0,20	0,10-0,20	0,20-0,50	15 (10-20)	35 (20-60)	40 (20-80)	-	-	-	-	-
P11	NF/NS-EB45	0,10-0,15	0,1-0,20	0,10-0,20	0,20-0,50	15 (10-20)	35 (20-60)	40 (20-80)	-	-	-	-	-
P12	NF/NS-EB45	0,10-0,15	0,1-0,20	0,10-0,20	0,20-0,50	12 (8-15)	25 (15-45)	30 (15-65)	-	-	-	-	-
M1	NF/NS-EB45	0,08-0,15	0,10-0,15	0,10-0,20	0,20-0,50	12 (9-15)	25 (15-40)	35 (20-60)	-	-	25 (15-40)	40 (20-60)	-
M2	NF/NS-EB45	0,08-0,15	0,10-0,15	0,10-0,20	0,20-0,50	-	25 (15-40)	35 (20-60)	-	-	25 (15-40)	40 (20-60)	-
M3	NF/NS-EB45	0,08-0,15	0,10-0,15	0,10-0,20	0,20-0,50	-	25 (15-40)	35 (20-60)	-	-	25 (15-40)	40 (20-60)	-
M4	NF/NS-EB45	0,08-0,15	0,10-0,15	0,10-0,20	0,20-0,50	-	20 (10-30)	25 (15-40)	-	-	25 (10-30)	30 (15-40)	-
M5	NF/NS-EB45	0,08-0,15	0,10-0,15	0,10-0,20	0,20-0,50	-	20 (10-30)	25 (15-40)	-	-	25 (10-30)	30 (15-40)	-
K1	NF/NS-EB45	0,10-0,20	0,10-0,25	0,10-0,30	0,20-0,60	25 (15-30)	60 (40-100)	80 (30-150)	90 (35-170)	-	-	-	-
K2	NF/NS-EB45	0,10-0,20	0,10-0,25	0,10-0,30	0,20-0,60	-	25 (20-40)	40 (30-70)	45 (35-80)	-	-	-	-
K3	NF/NS-EB45	0,10-0,20	0,10-0,25	0,10-0,30	0,20-0,60	25 (15-30)	60 (40-100)	80 (30-150)	90 (35-170)	-	-	-	-
K4	NF/NS-EB45	0,10-0,20	0,10-0,25	0,10-0,30	0,20-0,60	25 (15-30)	45 (30-70)	70 (40-120)	80 (45-135)	-	-	-	-
K5	NF/NS-EB45	0,10-0,20	0,10-0,25	0,10-0,30	0,20-0,60	25 (15-30)	45 (30-70)	70 (40-120)	80 (45-135)	-	-	-	-
K6	NF/NS-EB45	0,10-0,20	0,10-0,25	0,10-0,30	0,20-0,60	-	60 (40-100)	80 (30-150)	90 (35-170)	-	-	-	-
K7	NF/NS-EB45	0,10-0,20	0,10-0,25	0,10-0,30	0,20-0,60	-	60 (40-100)	80 (30-150)	90 (35-170)	-	-	-	-
N1	NF/NS-EB45	0,10-0,20	0,10-0,30	0,10-0,30	0,20-0,60	50 (20-80)	-	80 (30-150)	-	50 (20-80)	-	-	-
N2	NF/NS-EB45	0,10-0,20	0,10-0,30	0,10-0,30	0,20-0,60	50 (20-80)	-	80 (30-150)	-	50 (20-80)	-	-	-
N3	NF/NS-EB45	0,10-0,20	0,10-0,30	0,10-0,30	0,20-0,60	50 (20-80)	-	80 (30-150)	-	50 (20-80)	-	-	-
N4	NF/NS-EB45	0,10-0,20	0,10-0,30	0,10-0,30	0,20-0,60	50 (20-80)	-	80 (30-150)	-	50 (20-80)	-	-	-
S1	NF/NS-EB45	0,08-0,15	0,10-0,15	0,10-0,20	0,20-0,30	-	15 (8-20)	20 (10-25)	-	-	-	-	20 (10-25)
S2	NF/NS-EB45	0,08-0,15	0,10-0,15	0,10-0,20	0,20-0,30	-	15 (8-20)	20 (10-25)	-	-	-	-	20 (10-25)
S3	NF/NS-EB45	0,08-0,15	0,10-0,15	0,10-0,20	0,20-0,30	-	15 (8-20)	20 (10-25)	-	-	-	-	25 (10-25)
S11	NF/NS-EB45	0,08-0,15	0,10-0,15	0,10-0,20	0,20-0,30	20 (15-30)	30 (15-40)	40 (20-50)	-	-	-	-	30 (20-50)
S12	NF/NS-EB45	0,08-0,15	0,10-0,15	0,10-0,20	0,20-0,30	20 (15-30)	30 (15-40)	40 (20-50)	-	-	-	-	30 (20-50)
S13	NF/NS-EB45	0,08-0,15	0,10-0,15	0,10-0,20	0,20-0,30	20 (15-30)	30 (15-40)	40 (20-50)	-	-	-	-	30 (20-50)

La tabella continua alla pagina successiva.

Introduzione

Foratura

Alesatura

Barenatura

Allegato

Parametri di taglio – NF/NS...-EB45 misure metriche

SMG		$a_p (\varnothing)$		f		v_c							
		z=4	z=6	z=4	z=6	H15	CP20	RX2000	RK2050	RN2010	RM2020	RM2090	RS2090
Introduzione	H3	0,08- 0,15	0,10- 0,15	0,10- 0,20	0,20- 0,30	-	-	10 (8-15)	-	-	-	-	-
	H5	0,08- 0,15	0,10- 0,15	0,10- 0,20	0,20- 0,30	-	-	10 (8-15)	-	-	-	-	-
	H7	0,08- 0,15	0,10- 0,15	0,10- 0,20	0,20- 0,30	-	-	10 (8-15)	-	-	-	-	-
	H8	0,08- 0,15	0,10- 0,15	0,10- 0,20	0,20- 0,30	-	-	10 (8-15)	-	-	-	-	-
	H11	0,08- 0,15	0,10- 0,15	0,10- 0,20	0,20- 0,30	-	-	10 (8-15)	-	-	-	-	-
	H12	0,08- 0,15	0,10- 0,15	0,10- 0,20	0,20- 0,30	-	-	10 (8-15)	-	-	-	-	-
	H21	0,08- 0,15	0,10- 0,15	0,10- 0,20	0,20- 0,30	-	-	10 (8-15)	-	-	-	-	-
	H31	0,08- 0,15	0,10- 0,15	0,10- 0,20	0,20- 0,30	-	-	10 (8-15)	-	-	-	-	-
	Foratura	PM1	0,10- 0,15	0,1- 0,20	0,10- 0,20	0,20- 0,50	-	50 (30-80)	70 (40-100)	-	-	-	-
PM2		0,10- 0,15	0,1- 0,20	0,10- 0,20	0,20- 0,50	-	50 (30-80)	70 (40-100)	-	-	-	-	-
PM3		0,10- 0,15	0,1- 0,20	0,10- 0,20	0,20- 0,50	-	50 (30-80)	70 (40-100)	-	-	-	-	-
TS1		0,10- 0,15	0,1- 0,20	0,10- 0,30	0,20- 0,60	20 (15-25)	-	40 (20-60)	-	-	-	-	-
TS2		0,10- 0,15	0,1- 0,20	0,10- 0,30	0,20- 0,60	20 (15-25)	-	40 (20-60)	-	-	-	-	-
TS3		0,10- 0,15	0,1- 0,20	0,10- 0,30	0,20- 0,60	20 (15-25)	-	40 (20-60)	-	-	-	-	-
TS4		0,10- 0,15	0,1- 0,20	0,10- 0,30	0,20- 0,60	20 (15-25)	-	40 (20-60)	-	-	-	-	-
TP1		0,10- 0,15	0,1- 0,20	0,10- 0,30	0,20- 0,60	20 (15-25)	-	40 (20-60)	-	-	-	-	-
TP2		0,10- 0,15	0,1- 0,20	0,10- 0,30	0,20- 0,60	20 (15-25)	-	40 (20-60)	-	-	-	-	-
Alesatura	TP3	0,10- 0,15	0,1- 0,20	0,10- 0,30	0,20- 0,60	20 (15-25)	-	40 (20-60)	-	-	-	-	-
	TP4	0,10- 0,15	0,1- 0,20	0,10- 0,30	0,20- 0,60	20 (15-25)	-	40 (20-60)	-	-	-	-	-
	GR1	0,10- 0,15	0,1- 0,20	0,10- 0,30	0,20- 0,60	40 (80-20)	-	60 (30-120)	-	-	-	-	-

SMG = Gruppo materiale Seco

a_p = mm

f = mm/rev

v_c = m/min

Tutti i parametri di taglio sono valori di partenza

Parametri di taglio – NF/NS...-EB45 pollici

SMG		a _p (°)		f		v _c							
		z=4	z=6	z=4	z=6	H15	CP20	RX2000	RK2050	RN2010	RM2020	RM2090	RS2090
P1	NF/NS-EB45	0.004-0.006	0.004-0.008	0.004-0.012	0.008-0.024	80 (50-100)	195 (100-330)	260 (100-490)	-	-	-	-	-
P2	NF/NS-EB45	0.004-0.006	0.004-0.008	0.012	0.024	80 (50-100)	195 (100-330)	260 (100-490)	-	-	-	-	-
P3	NF/NS-EB45	0.004-0.006	0.004-0.008	0.004-0.012	0.008-0.024	80 (50-100)	195 (100-330)	260 (100-490)	-	-	-	-	-
P4	NF/NS-EB45	0.004-0.006	0.004-0.008	0.004-0.008	0.008-0.020	65 (35-80)	165 (100-260)	195 (100-395)	-	-	-	-	-
P5	NF/NS-EB45	0.004-0.006	0.004-0.008	0.004-0.008	0.008-0.020	65 (35-80)	165 (100-260)	195 (100-395)	-	-	-	-	-
P6	NF/NS-EB45	0.004-0.006	0.004-0.008	0.004-0.008	0.008-0.020	65 (35-80)	165 (100-260)	195 (100-395)	-	-	-	-	-
P7	NF/NS-EB45	0.004-0.006	0.004-0.008	0.004-0.008	0.008-0.020	65 (35-80)	165 (100-260)	195 (100-395)	-	-	-	-	-
P8	NF/NS-EB45	0.004-0.006	0.004-0.008	0.004-0.008	0.008-0.020	50 (35-65)	115 (65-195)	130 (65-260)	-	-	-	-	-
P11	NF/NS-EB45	0.004-0.006	0.004-0.008	0.004-0.008	0.008-0.020	50 (35-65)	115 (65-195)	130 (65-260)	-	-	-	-	-
P12	NF/NS-EB45	0.004-0.006	0.004-0.008	0.004-0.008	0.008-0.020	40 (25-50)	80 (50-150)	100 (50-215)	-	-	-	-	-
M1	NF/NS-EB45	0.003-0.006	0.004-0.006	0.004-0.008	0.008-0.020	40 (30-50)	80 (50-130)	115 (65-195)	-	-	80 (50-130)	130 (65-195)	-
M2	NF/NS-EB45	0.003-0.006	0.004-0.006	0.004-0.008	0.008-0.020	-	80 (50-130)	115 (65-195)	-	-	80 (50-130)	130 (65-195)	-
M3	NF/NS-EB45	0.003-0.006	0.004-0.006	0.004-0.008	0.008-0.020	-	80 (50-130)	115 (65-195)	-	-	80 (50-130)	130 (65-195)	-
M4	NF/NS-EB45	0.003-0.006	0.004-0.006	0.004-0.008	0.008-0.020	-	65 (35-100)	80 (50-130)	-	-	65 (35-100)	100 (50-130)	-
M5	NF/NS-EB45	0.003-0.006	0.004-0.006	0.004-0.008	0.008-0.020	-	65 (35-100)	80 (50-130)	-	-	65 (35-100)	100 (50-130)	-
K1	NF/NS-EB45	0.004-0.008	0.004-0.010	0.004-0.012	0.008-0.024	80 (50-100)	195 (130-330)	260 (100-490)	290 (110-550)	-	-	-	-
K2	NF/NS-EB45	0.004-0.008	0.004-0.010	0.004-0.012	0.008-0.024	-	80 (65-130)	130 (100-230)	145 (110-260)	-	-	-	-
K3	NF/NS-EB45	0.004-0.008	0.004-0.010	0.004-0.012	0.008-0.024	80 (50-100)	195 (130-330)	260 (100-490)	290 (110-550)	-	-	-	-
K4	NF/NS-EB45	0.004-0.008	0.004-0.010	0.004-0.012	0.008-0.024	80 (50-100)	150 (100-230)	230 (130-395)	260 (145-440)	-	-	-	-
K5	NF/NS-EB45	0.004-0.008	0.004-0.010	0.004-0.012	0.008-0.024	80 (50-100)	150 (100-230)	230 (130-395)	260 (145-440)	-	-	-	-
K6	NF/NS-EB45	0.004-0.008	0.004-0.010	0.004-0.012	0.008-0.024	-	195 (130-330)	260 (100-490)	290 (110-550)	-	-	-	-
K7	NF/NS-EB45	0.004-0.008	0.004-0.010	0.004-0.012	0.008-0.024	-	195 (130-330)	260 (100-490)	290 (110-550)	-	-	-	-
N1	NF/NS-EB45	0.004-0.787	0.004-0.012	0.004-0.012	0.008-0.024	165 (65-260)	-	260 (100-490)	-	165 (65-260)	-	-	-
N2	NF/NS-EB45	0.004-0.787	0.004-0.012	0.004-0.012	0.008-0.024	165 (65-260)	-	260 (100-490)	-	165 (65-260)	-	-	-
N3	NF/NS-EB45	0.004-0.787	0.004-0.012	0.004-0.012	0.008-0.024	165 (65-260)	-	260 (100-490)	-	165 (65-260)	-	-	-
N4	NF/NS-EB45	0.004-0.787	0.004-0.012	0.004-0.012	0.008-0.024	165 (65-260)	-	260 (100-490)	-	165 (65-260)	-	-	-
S1	NF/NS-EB45	0.003-0.006	0.004-0.006	0.004-0.008	0.008-0.012	-	50 (25-65)	65 (35-80)	-	-	-	-	65 (35-80)
S2	NF/NS-EB45	0.003-0.006	0.004-0.006	0.004-0.008	0.008-0.012	-	50 (25-65)	65 (35-80)	-	-	-	-	65 (35-80)
S3	NF/NS-EB45	0.003-0.006	0.004-0.006	0.004-0.008	0.008-0.012	-	50 (25-65)	65 (35-80)	-	-	-	-	80 (35-80)
S11	NF/NS-EB45	0.003-0.006	0.004-0.006	0.004-0.008	0.008-0.012	65 (50-100)	100 (50-130)	130 (65-165)	-	-	-	-	100 (65-165)
S12	NF/NS-EB45	0.003-0.006	0.004-0.006	0.004-0.008	0.008-0.012	65 (50-100)	100 (50-130)	130 (65-165)	-	-	-	-	100 (65-165)
S13	NF/NS-EB45	0.003-0.006	0.004-0.006	0.004-0.008	0.008-0.012	65 (50-100)	100 (50-130)	130 (65-165)	-	-	-	-	100 (65-165)

La tabella continua alla pagina successiva.

Introduzione

Foratura

Alesatura

Barenatura

Allegato

Parametri di taglio – NF/NS...-EB45 pollici

SMG		a_p (°)		f		v_c							
		z=4	z=6	z=4	z=6	H15	CP20	RX2000	RK2050	RN2010	RM2020	RM2090	RS2090
H3	NF/NS-EB45	0.003-0.006	0.004-0.006	0.004-0.008	0.008-0.012	-	-	35 (25-50)	-	-	-	-	-
H5	NF/NS-EB45	0.003-0.006	0.004-0.006	0.004-0.008	0.008-0.012	-	-	35 (25-50)	-	-	-	-	-
H7	NF/NS-EB45	0.003-0.006	0.004-0.006	0.004-0.008	0.008-0.012	-	-	35 (25-50)	-	-	-	-	-
H8	NF/NS-EB45	0.003-0.006	0.004-0.006	0.004-0.008	0.008-0.012	-	-	35 (25-50)	-	-	-	-	-
H11	NF/NS-EB45	0.003-0.006	0.004-0.006	0.004-0.008	0.008-0.012	-	-	35 (25-50)	-	-	-	-	-
H12	NF/NS-EB45	0.003-0.006	0.004-0.006	0.004-0.008	0.008-0.012	-	-	35 (25-50)	-	-	-	-	-
H21	NF/NS-EB45	0.003-0.006	0.004-0.006	0.004-0.008	0.008-0.012	-	-	35 (25-50)	-	-	-	-	-
H31	NF/NS-EB45	0.003-0.006	0.004-0.006	0.004-0.008	0.008-0.012	-	-	35 (25-50)	-	-	-	-	-
PM1	NF/NS-EB45	0.004-0.006	0.004-0.008	0.004-0.008	0.008-0.020	-	165 (100-260)	230 (130-350)	-	-	-	-	-
PM2	NF/NS-EB45	0.004-0.006	0.004-0.008	0.004-0.008	0.008-0.020	-	165 (100-260)	230 (130-350)	-	-	-	-	-
PM3	NF/NS-EB45	0.004-0.006	0.004-0.008	0.004-0.008	0.008-0.020	-	165 (100-260)	230 (130-350)	-	-	-	-	-
TS1	NF/NS-EB45	0.004-0.006	0.004-0.008	0.004-0.012	0.008-0.024	65 (50-80)	-	130 (65-195)	-	-	-	-	-
TS2	NF/NS-EB45	0.004-0.006	0.004-0.008	0.004-0.012	0.008-0.024	65 (50-80)	-	130 (65-195)	-	-	-	-	-
TS3	NF/NS-EB45	0.004-0.006	0.004-0.008	0.004-0.012	0.008-0.024	65 (50-80)	-	130 (65-195)	-	-	-	-	-
TS4	NF/NS-EB45	0.004-0.006	0.004-0.008	0.004-0.012	0.008-0.024	65 (50-80)	-	130 (65-195)	-	-	-	-	-
TP1	NF/NS-EB45	0.004-0.006	0.004-0.008	0.004-0.012	0.008-0.024	65 (50-80)	-	130 (65-195)	-	-	-	-	-
TP2	NF/NS-EB45	0.004-0.006	0.004-0.008	0.004-0.012	0.008-0.024	65 (50-80)	-	130 (65-195)	-	-	-	-	-
TP3	NF/NS-EB45	0.004-0.006	0.004-0.008	0.004-0.012	0.008-0.024	65 (50-80)	-	130 (65-195)	-	-	-	-	-
TP4	NF/NS-EB45	0.004-0.006	0.004-0.008	0.004-0.012	0.008-0.024	65 (50-80)	-	130 (65-195)	-	-	-	-	-
GR1	NF/NS-EB45	0.004-0.006	0.004-0.008	0.004-0.012	0.008-0.024	130 (65-260)	-	195 (100-395)	-	-	-	-	-

SMG = Gruppo materiale Seco

a_p = inch

f = in/rev

v_c = sf/min

Tutti i parametri di taglio sono valori di partenza

Parametri di taglio – NF/NS...-EB845 misure metriche

SMG		a _p (°)		f		v _c						
		z=4	z=6	z=4	z=6	H15	CP20	RX2000	RK2050	RM2020	RM2090	RS2090
P3	NF/NS-EB845	0,10	0,1	0,10	0,20	-	60	80	-	-	-	-
		-0,15	-0,20	-0,30	-0,60							
P4	NF/NS-EB845	0,10	0,1	0,10	0,20	-	50	60	-	-	-	-
		-0,15	-0,20	-0,20	-0,50							
P5	NF/NS-EB845	0,10	0,1	0,10	0,20	20	50	60	-	-	-	-
		-0,15	-0,20	-0,20	-0,50							
P6	NF/NS-EB845	0,10	0,1	0,10	0,20	20	50	60	-	-	-	-
		-0,15	-0,20	-0,20	-0,50							
P7	NF/NS-EB845	0,10	0,1	0,10	0,20	20	50	60	-	-	-	-
		-0,15	-0,20	-0,20	-0,50							
P8	NF/NS-EB845	0,10	0,1	0,10	0,20	15	35	40	-	-	-	-
		-0,15	-0,20	-0,20	-0,50							
P11	NF/NS-EB845	0,10	0,1	0,10	0,20	15	35	40	-	-	-	-
		-0,15	-0,20	-0,20	-0,50							
P12	NF/NS-EB845	0,10	0,1	0,10	0,20	12	25	30	-	-	-	-
		-0,15	-0,20	-0,20	-0,50							
M1	NF/NS-EB845	0,08	0,10	0,10	0,20	12	25	35	-	25	40	-
		-0,15	-0,15	-0,20	-0,50							
M2	NF/NS-EB845	0,08	0,10	0,10	0,20	-	25	35	-	25	40	-
		-0,15	-0,15	-0,20	-0,50							
M3	NF/NS-EB845	0,08	0,10	0,10	0,20	-	25	35	-	25	40	-
		-0,15	-0,15	-0,20	-0,50							
M4	NF/NS-EB845	0,08	0,10	0,10	0,20	-	20	25	-	25	30	-
		-0,15	-0,15	-0,20	-0,50							
M5	NF/NS-EB845	0,08	0,10	0,10	0,20	-	20	25	-	25	30	-
		-0,15	-0,15	-0,20	-0,50							
K1	NF/NS-EB845	0,10	0,10	0,10	0,20	25	60	80	90	-	-	-
		-0,20	-0,25	-0,30	-0,60							
K2	NF/NS-EB845	0,10	0,10	0,10	0,20	-	25	40	45	-	-	-
		-0,20	-0,25	-0,30	-0,60							
K3	NF/NS-EB845	0,10	0,10	0,10	0,20	25	60	80	90	-	-	-
		-0,20	-0,25	-0,30	-0,60							
K4	NF/NS-EB845	0,10	0,10	0,10	0,20	25	45	70	80	-	-	-
		-0,20	-0,25	-0,30	-0,60							
K5	NF/NS-EB845	0,10	0,10	0,10	0,20	25	45	70	80	-	-	-
		-0,20	-0,25	-0,30	-0,60							
K6	NF/NS-EB845	0,10	0,10	0,10	0,20	-	60	80	90	-	-	-
		-0,20	-0,25	-0,30	-0,60							
K7	NF/NS-EB845	0,10	0,10	0,10	0,20	-	60	80	90	-	-	-
		-0,20	-0,25	-0,30	-0,60							
S1	NF/NS-EB845	0,08	0,10	0,10	0,20	-	15	20	-	-	-	20
		-0,15	-0,15	-0,20	0,30							
S2	NF/NS-EB845	0,08	0,10	0,10	0,20	-	15	20	-	-	-	20
		-0,15	-0,15	-0,20	0,30							
S3	NF/NS-EB845	0,08	0,10	0,10	0,20	-	15	20	-	-	-	25
		-0,15	-0,15	-0,20	0,30							
S11	NF/NS-EB845	0,08	0,10	0,10	0,20	20	30	40	-	-	-	30
		-0,15	-0,15	-0,20	0,30							
S12	NF/NS-EB845	0,08	0,10	0,10	0,20	20	30	40	-	-	-	30
		-0,15	-0,15	-0,20	0,30							
S13	NF/NS-EB845	0,08	0,10	0,10	0,20	20	30	40	-	-	-	30
		-0,15	-0,15	-0,20	0,30							
H3	NF/NS-EB845	0,08	0,10	0,10	0,20	-	-	10	-	-	-	-
		-0,15	-0,15	-0,20	0,30							
H5	NF/NS-EB845	0,08	0,10	0,10	0,20	-	-	10	-	-	-	-
		-0,15	-0,15	-0,20	0,30							
H7	NF/NS-EB845	0,08	0,10	0,10	0,20	-	-	10	-	-	-	-
		-0,15	-0,15	-0,20	0,30							
H8	NF/NS-EB845	0,08	0,10	0,10	0,20	-	-	10	-	-	-	-
		-0,15	-0,15	-0,20	0,30							
H11	NF/NS-EB845	0,08	0,10	0,10	0,20	-	-	10	-	-	-	-
		-0,15	-0,15	-0,20	0,30							
H12	NF/NS-EB845	0,08	0,10	0,10	0,20	-	-	10	-	-	-	-
		-0,15	-0,15	-0,20	0,30							
H21	NF/NS-EB845	0,08	0,10	0,10	0,20	-	-	10	-	-	-	-
		-0,15	-0,15	-0,20	0,30							
H31	NF/NS-EB845	0,08	0,10	0,10	0,20	-	-	10	-	-	-	-
		-0,15	-0,15	-0,20	0,30							
PM1	NF/NS-EB845	0,10	0,1	0,10	0,20	-	50	70	-	-	-	-
		-0,15	-0,20	-0,20	-0,50							
PM2	NF/NS-EB845	0,10	0,1	0,10	0,20	-	50	70	-	-	-	-
		-0,15	-0,20	-0,20	-0,50							
PM3	NF/NS-EB845	0,10	0,1	0,10	0,20	-	50	70	-	-	-	-
		-0,15	-0,20	-0,20	-0,50							

SMG = Gruppo materiale Seco

a_p = mm

f = mm/rev

v_c = m/min

Tutti i parametri di taglio sono valori di partenza

Parametri di taglio – NF/NS...-EB845 pollici

SMG		a_p (°)		f		v_c							
		z=4	z=6	z=4	z=6	H15	CP20	RX2000	RK2050	RM2020	RM2090	RS2090	
Introduzione	P3	NF/NS-EB845	0.004 -0.006	0.004 -0.008	0.004 -0.012	0.008 -0.024	-	195 (100-330)	260 (100-490)	-	-	-	-
	P4	NF/NS-EB845	0.004 -0.006	0.004 -0.008	0.004 -0.008	0.008 -0.020	-	165 (100-260)	195 (100-395)	-	-	-	-
	P5	NF/NS-EB845	0.004 -0.006	0.004 -0.008	0.004 -0.008	0.008 -0.020	65 (35-80)	165 (100-260)	195 (100-395)	-	-	-	-
	P6	NF/NS-EB845	0.004 -0.006	0.004 -0.008	0.004 -0.008	0.008 -0.020	65 (35-80)	165 (100-260)	195 (100-395)	-	-	-	-
	P7	NF/NS-EB845	0.004 -0.006	0.004 -0.008	0.004 -0.008	0.008 -0.020	65 (35-80)	165 (100-260)	195 (100-395)	-	-	-	-
	P8	NF/NS-EB845	0.004 -0.006	0.004 -0.008	0.004 -0.008	0.008 -0.020	50 (35-65)	115 (65-195)	130 (65-260)	-	-	-	-
	P11	NF/NS-EB845	0.004 -0.006	0.004 -0.008	0.004 -0.008	0.008 -0.020	50 (35-65)	115 (65-195)	130 (65-260)	-	-	-	-
	P12	NF/NS-EB845	0.004 -0.006	0.004 -0.008	0.004 -0.008	0.008 -0.020	40 (25-50)	80 (50-150)	100 (50-125)	-	-	-	-
Foratura	M1	NF/NS-EB845	0.003 -0.006	0.004 -0.006	0.004 -0.008	0.008 -0.02	40 (30-50)	80 (50-150)	115 (65-200)	-	80 (50-130)	130 (65-195)	-
	M2	NF/NS-EB845	0.003 -0.006	0.004 -0.006	0.004 -0.008	0.008 -0.02	-	80 (50-150)	115 (65-200)	-	80 (50-130)	130 (65-195)	-
	M3	NF/NS-EB845	0.003 -0.006	0.004 -0.006	0.004 -0.008	0.008 -0.02	-	80 (50-150)	115 (65-200)	-	80 (50-130)	130 (65-195)	-
	M4	NF/NS-EB845	0.003 -0.006	0.004 -0.006	0.004 -0.008	0.008 -0.02	-	65 (30-100)	80 (50-135)	-	80 (35-100)	100 (50-130)	-
	M5	NF/NS-EB845	0.003 -0.006	0.004 -0.006	0.004 -0.008	0.008 -0.02	-	65 (30-100)	80 (50-135)	-	80 (35-100)	100 (50-130)	-
Alesatura	K1	NF/NS-EB845	0.004 -0.008	0.004 -0.010	0.004 -0.012	0.008 -0.024	80 (50-100)	195 (130-330)	260 (100-490)	290 (110-550)	-	-	-
	K2	NF/NS-EB845	0.004 -0.008	0.004 -0.010	0.004 -0.012	0.008 -0.024	-	80 (65-130)	130 (100-230)	145 (110-260)	-	-	-
	K3	NF/NS-EB845	0.004 -0.008	0.004 -0.010	0.004 -0.012	0.008 -0.024	80 (50-100)	195 (130-330)	260 (100-490)	290 (110-550)	-	-	-
	K4	NF/NS-EB845	0.004 -0.008	0.004 -0.010	0.004 -0.012	0.008 -0.024	80 (50-100)	150 (100-330)	230 (130-395)	260 (145-440)	-	-	-
	K5	NF/NS-EB845	0.004 -0.008	0.004 -0.010	0.004 -0.012	0.008 -0.024	80 (50-100)	150 (100-330)	230 (130-395)	260 (145-440)	-	-	-
	K6	NF/NS-EB845	0.004 -0.008	0.004 -0.010	0.004 -0.012	0.008 -0.024	-	195 (130-330)	260 (100-490)	290 (110-550)	-	-	-
	K7	NF/NS-EB845	0.004 -0.008	0.004 -0.010	0.004 -0.012	0.008 -0.024	-	195 (130-330)	260 (100-490)	290 (110-550)	-	-	-
Barenatura	S1	NF/NS-EB845	0.003 -0.006	0.004 -0.006	0.004 -0.008	0.008 -0.012	-	50 (25-65)	65 (35-80)	-	-	-	65 (35-80)
	S2	NF/NS-EB845	0.003 -0.006	0.004 -0.006	0.004 -0.008	0.008 -0.012	-	50 (25-65)	65 (35-80)	-	-	-	65 (35-80)
	S3	NF/NS-EB845	0.003 -0.006	0.004 -0.006	0.004 -0.008	0.008 -0.012	-	50 (25-65)	65 (35-80)	-	-	-	65 (35-80)
	S11	NF/NS-EB845	0.003 -0.006	0.004 -0.006	0.004 -0.008	0.008 -0.012	65 (50-100)	100 (50-130)	130 (65-165)	-	-	-	100 (65-165)
	S12	NF/NS-EB845	0.003 -0.006	0.004 -0.006	0.004 -0.008	0.008 -0.012	65 (50-100)	100 (50-130)	130 (65-165)	-	-	-	100 (65-165)
	S13	NF/NS-EB845	0.003 -0.006	0.004 -0.006	0.004 -0.008	0.008 -0.012	65 (50-100)	100 (50-130)	130 (65-165)	-	-	-	100 (65-165)
	H3	NF/NS-EB845	0.003 -0.006	0.004 -0.006	0.004 -0.008	0.008 -0.012	-	-	35 (25-50)	-	-	-	-
H5	NF/NS-EB845	0.003 -0.006	0.004 -0.006	0.004 -0.008	0.008 -0.012	-	-	35 (25-50)	-	-	-	-	
H7	NF/NS-EB845	0.003 -0.006	0.004 -0.006	0.004 -0.008	0.008 -0.012	-	-	35 (25-50)	-	-	-	-	
H8	NF/NS-EB845	0.003 -0.006	0.004 -0.006	0.004 -0.008	0.008 -0.012	-	-	35 (25-50)	-	-	-	-	
H11	NF/NS-EB845	0.003 -0.006	0.004 -0.006	0.004 -0.008	0.008 -0.012	-	-	35 (25-50)	-	-	-	-	
H12	NF/NS-EB845	0.003 -0.006	0.004 -0.006	0.004 -0.008	0.008 -0.012	-	-	35 (25-50)	-	-	-	-	
H21	NF/NS-EB845	0.003 -0.006	0.004 -0.006	0.004 -0.008	0.008 -0.012	-	-	35 (25-50)	-	-	-	-	
H31	NF/NS-EB845	0.003 -0.006	0.004 -0.006	0.004 -0.008	0.008 -0.012	-	-	35 (25-50)	-	-	-	-	
Allegato	PM1	NF/NS-EB845	0.004 -0.006	0.004 -0.008	0.004 -0.008	0.008 -0.020	-	165 (100-260)	230 (130-350)	-	-	-	-
	PM2	NF/NS-EB845	0.004 -0.006	0.004 -0.008	0.004 -0.008	0.008 -0.020	-	165 (100-260)	230 (130-350)	-	-	-	-
	PM3	NF/NS-EB845	0.004 -0.006	0.004 -0.008	0.004 -0.008	0.008 -0.020	-	165 (100-260)	230 (130-350)	-	-	-	-

SMG = Gruppo materiale Seco

a_p = inch

f = in/rev

v_c = sf/min

Tutti i parametri di taglio sono valori di partenza

Parametri di taglio – NF/NS...-EB25/EB30 misure metriche

SMG		a_p (∅)		f		v_c			
		z=4	z=6	z=4	z=6	H15	CP20	RX2000	RK2050
P1	NF/NS-EB25/EB30	0,10-0,15	0,1-0,20	0,3-0,9	0,5-1,2	25 (15-30)	60 (30-100)	80 (30-150)	-
P2	NF/NS-EB25/EB30	0,10-0,15	0,1-0,20	0,3-0,9	0,5-1,2	25 (15-30)	60 (30-100)	80 (30-150)	-
P3	NF/NS-EB25/EB30	0,10-0,15	0,1-0,20	0,3-0,9	0,5-1,2	25 (15-30)	60 (30-100)	80 (30-150)	-
P4	NF/NS-EB25/EB30	0,10-0,15	0,1-0,20	0,3-0,7	0,5-1	20 (10-25)	50 (30-80)	60 (30-120)	-
P5	NF/NS-EB25/EB30	0,10-0,15	0,1-0,20	0,3-0,7	0,5-1	20 (10-25)	50 (30-80)	60 (30-120)	-
P6	NF/NS-EB25/EB30	0,10-0,15	0,1-0,20	0,3-0,7	0,5-1	20 (10-25)	50 (30-80)	60 (30-120)	-
P7	NF/NS-EB25/EB30	0,10-0,15	0,1-0,20	0,3-0,7	0,5-1	20 (10-25)	50 (30-80)	60 (30-120)	-
M1	NF/NS-EB25/EB30	0,08-0,15	0,10-0,15	0,3-0,7	0,5-1	-	25 (15-40)	35 (20-60)	-
K1	NF/NS-EB25/EB30	0,10-0,20	0,10-0,25	0,3-0,9	0,5-1,2	25 (15-30)	60 (40-100)	80 (30-150)	90 (35-170)
K2	NF/NS-EB25/EB30	0,10-0,20	0,10-0,25	0,3-0,9	0,5-1,2	-	25 (20-40)	40 (30-70)	45 (35-80)
K3	NF/NS-EB25/EB30	0,10-0,20	0,10-0,25	0,3-0,9	0,5-1,2	25 (15-30)	60 (40-100)	80 (30-150)	90 (35-170)
K4	NF/NS-EB25/EB30	0,10-0,20	0,10-0,25	0,3-0,9	0,5-1,2	25 (15-30)	45 (30-70)	70 (40-120)	80 (45-135)
K5	NF/NS-EB25/EB30	0,10-0,20	0,10-0,25	0,3-0,9	0,5-1,2	25 (15-30)	45 (30-70)	70 (40-120)	80 (45-135)
K6	NF/NS-EB25/EB30	0,10-0,20	0,10-0,25	0,3-0,9	0,5-1,2	-	60 (40-100)	80 (30-150)	90 (35-170)
K7	NF/NS-EB25/EB30	0,10-0,20	0,10-0,25	0,3-0,9	0,5-1,2	-	60 (40-100)	80 (30-150)	90 (35-170)
N1	NF/NS-EB25/EB30	0,10-0,20	0,10-0,30	0,3-0,9	0,5-1,2	50 (20-80)	-	-	-
N2	NF/NS-EB25/EB30	0,10-0,20	0,10-0,30	0,3-0,9	0,5-1,2	50 (20-80)	-	-	-
N3	NF/NS-EB25/EB30	0,10-0,20	0,10-0,30	0,3-0,9	0,5-1,2	50 (20-80)	-	-	-
N11	NF/NS-EB25/EB30	0,10-0,20	0,10-0,30	0,3-0,9	0,5-1,2	50 (20-80)	-	-	-
PM1	NF/NS-EB25/EB30	0,10-0,15	0,1-0,20	0,3-0,9	0,5-1,2	-	50 (30-80)	70 (40-100)	-
PM2	NF/NS-EB25/EB30	0,10-0,15	0,1-0,20	0,3-0,9	0,5-1,2	-	50 (30-80)	70 (40-100)	-
PM3	NF/NS-EB25/EB30	0,10-0,15	0,1-0,20	0,3-0,9	0,5-1,2	-	50 (30-80)	70 (40-100)	-

SMG = Gruppo materiale Seco

a_p = mm

f = mm/rev

v_c = m/min

Tutti i parametri di taglio sono valori di partenza

Introduzione

Foratura

Alesatura

Barenatura

Allegato

Parametri di taglio – NF/NS...-EB25/EB30 pollici

SMG		a_p (Z)		f		v_c			
		z=4	z=6	z=4	z=6	H15	CP20	RX2000	RK2050
P1	NF/NS-EB25/EB30	0.004-0.006	0.004-0.008	0.012-0.035	0.020-0.047	80 (50-100)	195 (100-330)	260 (100-490)	-
P2	NF/NS-EB25/EB30	0.004-0.006	0.004-0.008	0.012-0.035	0.020-0.047	80 (50-100)	195 (100-330)	260 (100-490)	-
P3	NF/NS-EB25/EB30	0.004-0.006	0.004-0.008	0.012-0.035	0.020-0.047	80 (50-100)	195 (100-330)	260 (100-490)	-
P4	NF/NS-EB25/EB30	0.004-0.006	0.004-0.008	0.012-0.028	0.020-0.039	65 (35-80)	165 (100-265)	195 (100-395)	-
P5	NF/NS-EB25/EB30	0.004-0.006	0.004-0.008	0.012-0.028	0.020-0.039	65 (35-80)	165 (100-265)	195 (100-395)	-
P6	NF/NS-EB25/EB30	0.004-0.006	0.004-0.008	0.012-0.028	0.020-0.039	65 (35-80)	165 (100-265)	195 (100-395)	-
P7	NF/NS-EB25/EB30	0.004-0.006	0.004-0.008	0.012-0.028	0.020-0.039	65 (35-80)	165 (100-265)	195 (100-395)	-
M1	NF/NS-EB25/EB30	0.003-0.006	0.004-0.006	0.012-0.028	0.020-0.039	-	80 (50-130)	115 (65-195)	-
K1	NF/NS-EB25/EB30	0.004-0.008	0.004-0.010	0.012-0.035	0.020-0.047	80 (50-100)	195 (130-330)	260 (100-490)	290 (110-550)
K2	NF/NS-EB25/EB30	0.004-0.008	0.004-0.010	0.012-0.035	0.020-0.047	-	80 (65-130)	130 (100-230)	145 (110-260)
K3	NF/NS-EB25/EB30	0.004-0.008	0.004-0.010	0.012-0.035	0.020-0.047	80 (50-100)	195 (130-330)	260 (100-490)	290 (110-550)
K4	NF/NS-EB25/EB30	0.004-0.008	0.004-0.010	0.012-0.035	0.020-0.047	80 (50-100)	150 (100-230)	230 (130-395)	260 (145-440)
K5	NF/NS-EB25/EB30	0.004-0.008	0.004-0.010	0.012-0.035	0.020-0.047	80 (50-100)	150 (100-230)	230 (130-395)	260 (145-440)
K6	NF/NS-EB25/EB30	0.004-0.008	0.004-0.010	0.012-0.035	0.020-0.047	-	195 (130-330)	260 (100-490)	290 (110-550)
K7	NF/NS-EB25/EB30	0.004-0.008	0.004-0.010	0.012-0.035	0.020-0.047	-	195 (130-330)	260 (100-490)	290 (110-550)
N1	NF/NS-EB25/EB30	0.004-0.787	0.004-0.012	0.012-0.035	0.020-0.047	165 (65-265)	-	-	-
N2	NF/NS-EB25/EB30	0.004-0.787	0.004-0.012	0.012-0.035	0.020-0.047	165 (65-265)	-	-	-
N3	NF/NS-EB25/EB30	0.004-0.787	0.004-0.012	0.012-0.035	0.020-0.047	165 (65-265)	-	-	-
N11	NF/NS-EB25/EB30	0.004-0.787	0.004-0.012	0.012-0.035	0.020-0.047	165 (65-265)	-	-	-
PM1	NF/NS-EB25/EB30	0.004-0.006	0.004-0.008	0.012-0.035	0.020-0.047	-	165 (100-265)	230 (130-330)	-
PM2	NF/NS-EB25/EB30	0.004-0.006	0.004-0.008	0.012-0.035	0.020-0.047	-	165 (100-265)	230 (130-330)	-
PM3	NF/NS-EB25/EB30	0.004-0.006	0.004-0.008	0.012-0.035	0.020-0.047	-	165 (100-265)	230 (130-330)	-

SMG = Gruppo materiale Seco

a_p = inch

f = in/rev

v_c = sf/min

Tutti i parametri di taglio sono valori di partenza

Introduzione

Foratura

Alesatura

Barenatura

Allegato

Istruzioni per la riaffilatura

Specifiche

Mola diamantata
Dimensione grana:
D6 per il 1° angolo di spoglia ($\beta_1 - \beta_3$)
D64 per il 2° angolo di spoglia (β_2)

Importante

La riaffilatura riduce il diametro dell'alesatore.
La riapplicazione del rivestimento può generare un aumento del diametro.
Errore di concentricità massimo sugli smussi di imbocco $10 \mu\text{m}$ ($394 \mu\text{in}$).

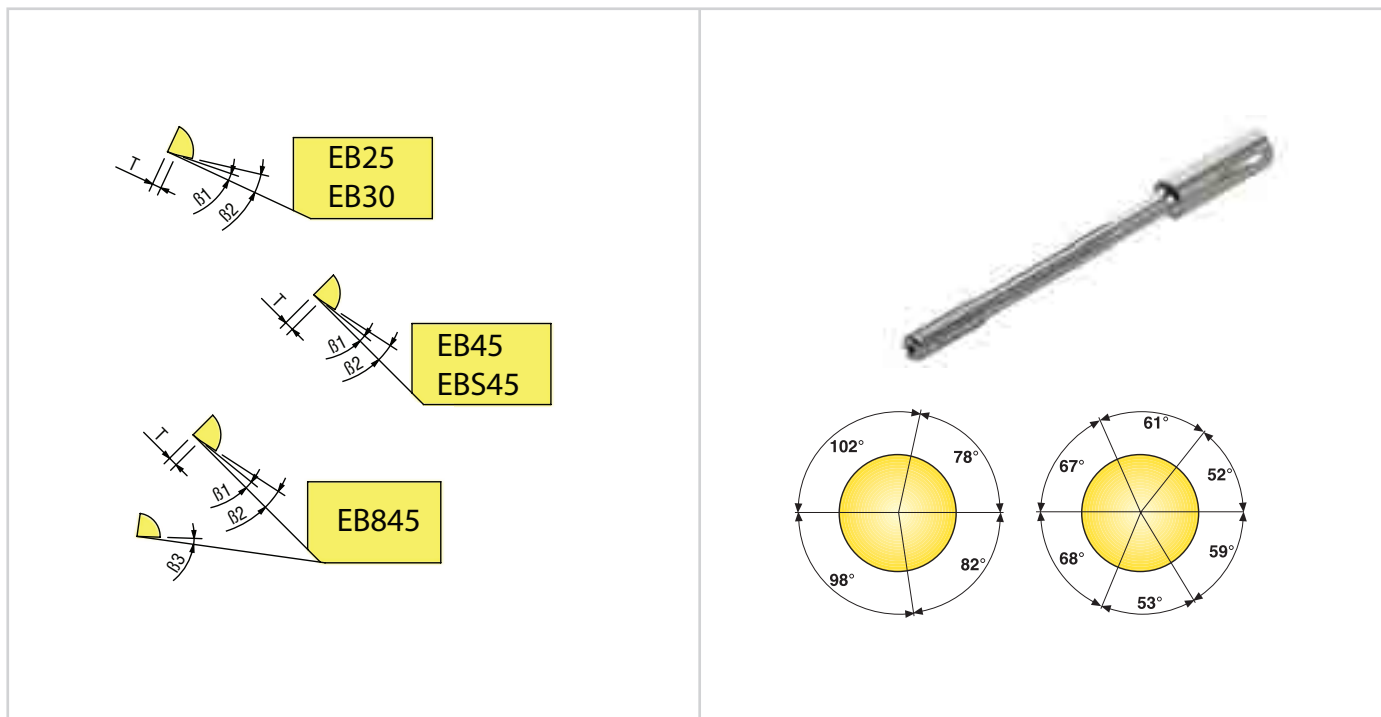

Nanofix \varnothing mm (pollici)	β_1	β_2	β_3	T mm (pollici)
2,97-9,99 (0.117-0.393)	8°	18°	8°	0,15 (0.006)
10,00-12,050 (0.394-0.474)	8°	18°	8°	0,20 (0.008)



Nanojet

Gli alesatori Nanojet in metallo duro integrale sono progettati per diametri piccoli, compresi tra 1.461 e 9.960 mm (0,117"-0,474"). Caratteristiche principali:

- Uscita del refrigerante ottimizzata
- Tolleranze comprese tra 10 e 15 μm (.0004" - .0006")
- Otto geometrie disponibili: EB45, EBS45, EB845, EB25, EB30, EBS30, EB60 e EB75

Panoramica della gamma

	Gamma ∅	Profondità di alesatura	Tolleranza ∅ foro	Diametro intermedio	Finitura superficiale
<p>Nanojet</p> 	1,461-9,960 mm (0.057-0.392")	~ 4-7 x D	IT 7	Disponibile tramite My Design	R _a 0,2-1,2 μm (R _a 7.87-47.2 μin)

Nanojet è un alesatore in metallo duro integrale dedicato a piccoli diametri da 1.461 a 9.960 mm (.057" - .392").

Il design include l'uscita ottimizzata del refrigerante che invia direttamente il liquido nelle scanalature in modo efficace e potente.

Chiave di codifica

Alesatori

Introduzione

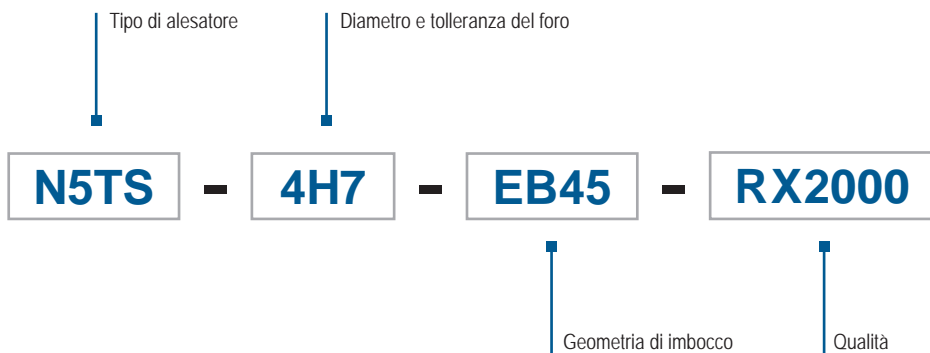

Foratura



Alesatori di diametro intermedio

Alesatura

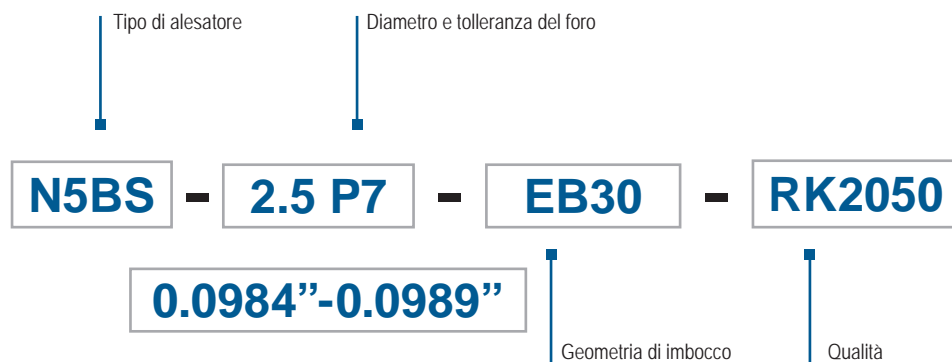

N5TS: Design a scanalatura dritta, adatto per fori passanti.
 N5BS: Design a scanalatura dritta, adatto per fori ciechi.
 N4BS: Design a scanalatura elicoidale destra, adatto per fori ciechi.

Si vedano la pagine 406 e seguenti, relative alla scelta delle geometrie Nanojet.

Barenatura

Allegato

Eccentricità

Utensile rotante

Massima eccentricità raccomandata: $5\ \mu\text{m}$ ($197\ \mu\text{in}$).
Si raccomanda un attacco di precisione: Attacco idraulico, porta pinze 5672.

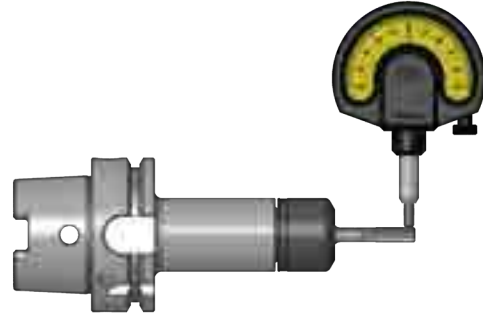

Utensile statico

Utilizzare un attacco flottante Seco, vedere le pagine 505-509.
Gli attacchi flottanti consentono all'alesatore di auto-centrarsi nel preforo.



Requisiti del refrigerante

Per la massima durata utensile ed una buona qualità del foro, si devono soddisfare i seguenti requisiti relativi al refrigerante.

Si raccomanda l'adduzione del refrigerante attraverso l'utensile.
L'adduzione esterna è possibile se le condizioni di taglio sono ridotte del 75%.

Olio solubile con almeno il 40% di olio minerale.
Per l'acciaio inossidabile si consiglia olio puro.

Concentrazione minima 6-8%.
Filtrazione $30-50\ \mu\text{m}$ ($1181-1969\ \mu\text{in}$).
Volume minimo $0,5\ \text{l/min/mm}$ ($0,13\ \text{gal/min/pollice}$) in rapporto al diametro utensile (esempio: alesatore $\varnothing 10$, il volume minimo è $5\ \text{l/min}$ ($1,3\ \text{gal/min}$)).

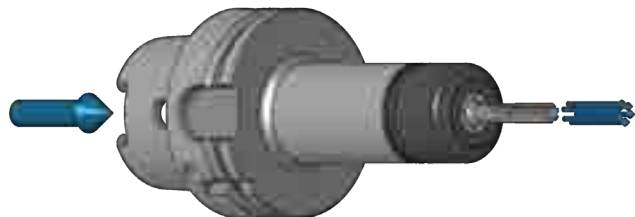

Misura diametro



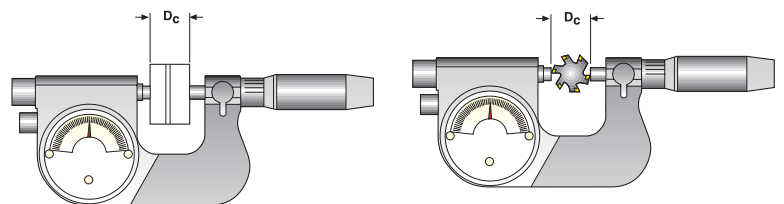

Calibrare il micrometro a quadrante prima della misura del \varnothing .

Importante!
Gli alesatori Nanojet hanno passo differenziato.
Durante la misura del diametro, è necessario assicurarsi di misurare due lame opposte a 180° .

Per le rilevazioni, utilizzare un micrometro a quadrante e dei tastatori comparatori.

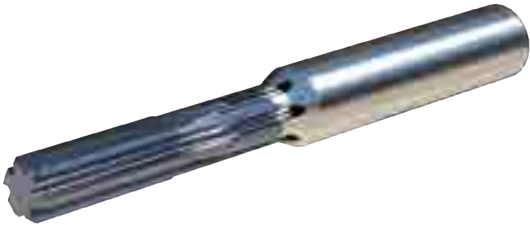
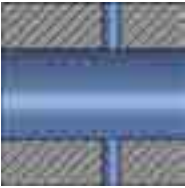
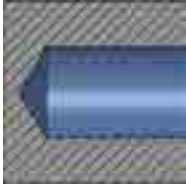

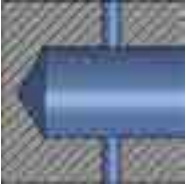
Scelta della geometria della scanalatura

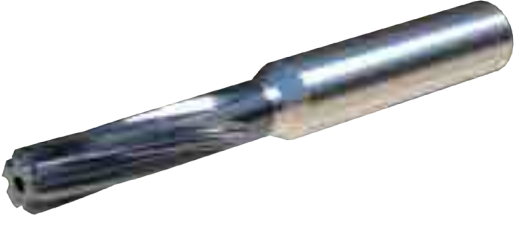
Pezzo in lavorazione		Diametro da alesare \varnothing 1.461-9.960 mm (0,057-0,392")	
Introduzione	<p>Fori passanti</p> 	<p>Tagli dritti</p> <p>N5T</p> 	
	<p>Fori passanti e fori incrociati</p> 		
Foratura	<p>Foro cieco</p> 	<p>Tagli dritti</p> <p>N5B</p> 	
	<p>Foro cieco attraverso un foro preesistente</p> 		
Alesatura	<p>Foro cieco > 3 x D</p> 	<p>Scanalature elicoidali DX</p> <p>N4B</p> 	
Barenatura			
Allegato			

Scelta della geometria – Applicazioni

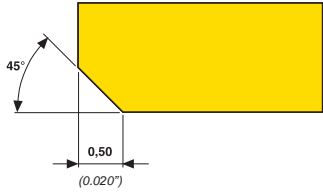
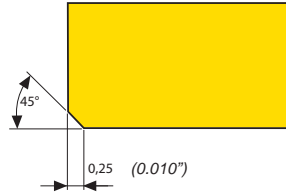
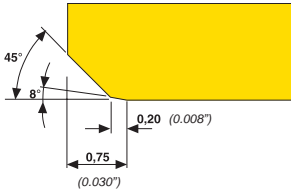
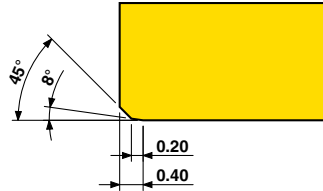
Geometria di imbocco - EB45		Introduzione
<p>Controllo truciolo ++ Finitura superficiale+++ R_a 0,8-1,2 μm (Finitura superficiale+++ R_a 31-47 μin) Versatile</p>		Foratura
<p>Controllo truciolo +++ Finitura superficiale + R_a 0,8-1,2 (Finitura superficiale + R_a 31-47 μin) EB45 corto</p>		Alesatura
<p>Controllo truciolo ++ Finitura superficiale+++ R_a 0,2-0,8 μm (Finitura superficiale+++ R_a 8-31 μin)</p>		Barenatura
<p>Controllo truciolo ++ Finitura superficiale+++ R_a 0,2-0,8 μm (Finitura superficiale+++ R_a 8-31 μin)</p>		Allegato

Nota: Per gli alesatori di piccolo diametro la lunghezza della geometria d'imbocco può essere leggermente inferiore rispetto a quanto riportato sopra.

Scelta della geometria – Applicazioni

Introduzione	<h3>Geometria di imbocco - EB25</h3>	
	<p>Possibilità di avanzamenti elevati +++ Finitura superficiale ++ R_a 0,4-0,8 μm (Finitura superficiale ++ R_a 16-31 μin) Controllo truciolo +</p>	
Foratura	<h3>Geometria di imbocco - EB30</h3>	
	<p>Possibilità di avanzamenti elevati +++ Finitura superficiale ++ (R_a 0,4-0,8 μm) (Finitura superficiale ++ R_a 16-31 μin) Controllo truciolo +</p>	
Alesatura	<h3>Geometria di imbocco - EBS30</h3>	
	<p>Possibilità di avanzamenti elevati +++ Finitura superficiale ++ R_a 0,4-0,8 μm (Finitura superficiale ++ R_a 16-31 μin) Controllo truciolo + EB30 corto</p>	

Nota: Per gli alesatori di piccolo diametro la lunghezza della geometria d'imbocco può essere leggermente inferiore rispetto a quanto riportato sopra.

Allegato

Scelta della geometria – Applicazioni

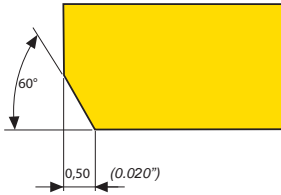
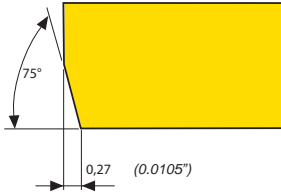
Geometria di imbocco - EB60	
<p>Possibilità di avanzamenti elevati + Finitura superficiale ++ R_a 0,8-1,2 μm (Finitura superficiale ++ R_a 31-47 μin) Controllo truciolo ++</p>	
Geometria di imbocco - EB75	
<p>Possibilità di avanzamenti elevati + Finitura superficiale ++ R_a 0,8-1,2 μm (Finitura superficiale ++ R_a 31-47 μin) Controllo truciolo ++</p>	

Nota: Per gli alesatori di piccolo diametro la lunghezza della geometria d'imbocco può essere leggermente inferiore rispetto a quanto riportato sopra.

Qualità		
Introduzione		RX2000 Rivestita Qualità rivestita ad alte prestazioni per tutti i materiali da lavorare.
		CP20 Rivestita Qualità rivestita versatile adatta per la maggior parte dei materiali da lavorare, tranne l'alluminio. TiN
Foratura		H15 Non rivestita Qualità micrograna tenace per tutti i materiali da lavorare. Adatta per operazioni di finitura, grazie all'affilatura del tagliente.
		RN2010 Non rivestita Qualità sub-micrograna non rivestita con geometrie ottimizzate per materiali N (non ferrosi).
		RM2020 Rivestita Qualità rivestita tenace per operazioni di finitura con geometrie ottimizzate per materiali M.
Alesatura		RM2090 Rivestita Qualità rivestita resistente all'usura con geometrie specifiche per materiali M. Ottimizzazione su materiali M.
		RK2050 Rivestita Qualità rivestita tenace per operazioni di finitura con geometrie ottimizzate per materiali K.
Barenatura		RS2090 Rivestita Qualità rivestita resistente all'usura con geometrie specifiche per materiali S. Ottimizzazione su materiali S.

Alesatore per fori passanti

Ø 2-9 mm / 0.0787-0.3150"

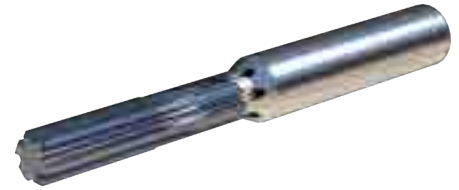
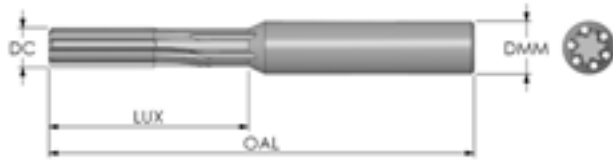

Codice di ordinazione	Codice prodotto	DC	Hole dia min-max		LUX	OAL	DMM		Geometrie			Qualità		
			mm Inch	mm Inch					mm Inch	mm Inch	mm Inch	mm Inch	EB45	EB845
N5TS-2H7-EB45	10238500	2,0 0.0787	2,0 0.0787	2,01 0.0791	12,0 0.4720	50,0 1.9690	3,0 0.1180	4	<input checked="" type="checkbox"/>	<input type="checkbox"/>	<input type="checkbox"/>	<input checked="" type="checkbox"/>	<input type="checkbox"/>	<input type="checkbox"/>
N5TS-3H7-EB45	10238501	3,0 0.1181	3,0 0.1181	3,01 0.1185	21,0 0.8270	50,0 1.9690	4,0 0.1570	4	<input checked="" type="checkbox"/>	<input type="checkbox"/>	<input type="checkbox"/>	<input checked="" type="checkbox"/>	<input type="checkbox"/>	<input type="checkbox"/>
N5TS-4H7-EB45	10238502	4,0 0.1575	4,0 0.1575	4,012 0.1580	28,0 1.1020	55,0 2.1650	5,0 0.1970	4	<input checked="" type="checkbox"/>	<input type="checkbox"/>	<input type="checkbox"/>	<input checked="" type="checkbox"/>	<input type="checkbox"/>	<input type="checkbox"/>
N5TS-5H7-EB45	10238503	5,0 0.1969	5,0 0.1969	5,012 0.1973	28,0 1.1020	55,0 2.1650	6,0 0.2360	4	<input checked="" type="checkbox"/>	<input type="checkbox"/>	<input type="checkbox"/>	<input checked="" type="checkbox"/>	<input type="checkbox"/>	<input type="checkbox"/>
N5TS-6H7-EB45	10238504	6,0 0.2362	6,0 0.2362	6,015 0.2368	30,0 1.1810	65,0 2.5590	8,0 0.3150	6	<input checked="" type="checkbox"/>	<input type="checkbox"/>	<input type="checkbox"/>	<input checked="" type="checkbox"/>	<input type="checkbox"/>	<input type="checkbox"/>
N5TS-6.35H7-EB45	10238506	6,35 0.2500	6,35 0.2500	6,365 0.2506	30,0 1.1810	65,0 2.5590	8,0 0.3150	6	<input checked="" type="checkbox"/>	<input type="checkbox"/>	<input type="checkbox"/>	<input checked="" type="checkbox"/>	<input type="checkbox"/>	<input type="checkbox"/>
N5TS-8H7-EB45	10238505	8,0 0.3150	8,0 0.3150	8,015 0.3156	40,0 1.5750	75,0 2.9530	10,0 0.3940	6	<input checked="" type="checkbox"/>	<input type="checkbox"/>	<input type="checkbox"/>	<input checked="" type="checkbox"/>	<input type="checkbox"/>	<input type="checkbox"/>

Prodotto standard a stock Prodotto standard non a stock.

Introduzione

Foratura

Alesatura

Barenatura

Allegato

Alesatore per fori passanti – Diametro intermedio

Elica diritta, versione corta – Ø 1,461-9,960 mm / 0.057- 0.392"

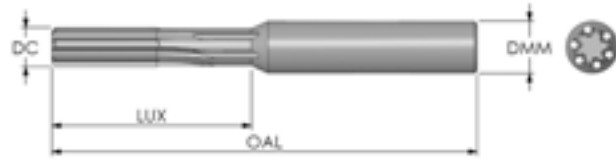

- Per la scelta della geometria, vedere le pagine 407-409
- Per i parametri di taglio raccomandati, vedere pagina(e) 414-421

Codice di ordinazione	DCN	DCX	LUX	DMM	OAL	Geometrie	Qualità							
	mm Inch	mm Inch	mm Inch	mm Inch	mm Inch		H15	RK2050	RX2000	RN2010	RM2020	RM2090	RS2090	
N5TS-1.461-XX.XXX	1,461 0.058	2,2 0.087	12,0 0.087	3,0 0.118	50,0 1.969	4	EB45 EB845 EB30 EB60...	<input type="checkbox"/>	<input type="checkbox"/>	<input type="checkbox"/>	<input type="checkbox"/>	<input type="checkbox"/>	<input type="checkbox"/>	<input type="checkbox"/>
N5TS-2.201-XX.XXX	2,201 0.087	2,96 0.117	17,0 0.117	3,0 0.118	50,0 1.969	4	EB45 EB845 EB30 EB60...	<input type="checkbox"/>	<input type="checkbox"/>	<input type="checkbox"/>	<input type="checkbox"/>	<input type="checkbox"/>	<input type="checkbox"/>	<input type="checkbox"/>
N5TS-2.961-XX.XXX	2,961 0.117	3,46 0.136	21,0 0.136	4,0 0.157	50,0 1.969	4	EB45 EB845 EB30 EB60...	<input type="checkbox"/>	<input type="checkbox"/>	<input type="checkbox"/>	<input type="checkbox"/>	<input type="checkbox"/>	<input type="checkbox"/>	<input type="checkbox"/>
N5TS-3.461-XX.XXX	3,461 0.136	3,96 0.156	23,0 0.156	4,0 0.157	50,0 1.969	4	EB45 EB845 EB30 EB60...	<input type="checkbox"/>	<input type="checkbox"/>	<input type="checkbox"/>	<input type="checkbox"/>	<input type="checkbox"/>	<input type="checkbox"/>	<input type="checkbox"/>
N5TS-3.961-XX.XXX	3,961 0.156	4,96 0.195	28,0 0.195	5,0 0.197	55,0 2.165	4	EB45 EB845 EB30 EB60...	<input type="checkbox"/>	<input type="checkbox"/>	<input type="checkbox"/>	<input type="checkbox"/>	<input type="checkbox"/>	<input type="checkbox"/>	<input type="checkbox"/>
N5TS-4.961-XX.XXX	4,961 0.195	5,96 0.235	28,0 0.235	6,0 0.236	55,0 2.165	4	EB45 EB845 EB30 EB60...	<input type="checkbox"/>	<input type="checkbox"/>	<input type="checkbox"/>	<input type="checkbox"/>	<input type="checkbox"/>	<input type="checkbox"/>	<input type="checkbox"/>
N5TS-5.961-XX.XXX	5,961 0.235	6,96 0.274	30,0 0.274	8,0 0.315	65,0 2.559	6	EB45 EB845 EB30 EB60...	<input type="checkbox"/>	<input type="checkbox"/>	<input type="checkbox"/>	<input type="checkbox"/>	<input type="checkbox"/>	<input type="checkbox"/>	<input type="checkbox"/>
N5TS-6.961-XX.XXX	6,961 0.274	7,96 0.313	31,0 0.313	8,0 0.315	65,0 2.559	-	EB45 EB845 EB30 EB60...	<input type="checkbox"/>	<input type="checkbox"/>	<input type="checkbox"/>	<input type="checkbox"/>	<input type="checkbox"/>	<input type="checkbox"/>	<input type="checkbox"/>
N5TS-7.961-XX.XXX	7,961 0.313	9,96 0.392	40,0 0.392	10,0 0.394	75,0 2.953	6	EB45 EB845 EB30 EB60...	<input type="checkbox"/>	<input type="checkbox"/>	<input type="checkbox"/>	<input type="checkbox"/>	<input type="checkbox"/>	<input type="checkbox"/>	<input type="checkbox"/>

= Prodotto standard non presente a magazzino

Nota: Quando si ordinano alesatori Nanojet per diametri intermedi, indicare il diametro e la tolleranza del foro da alesare.

Esempio d'ordine: N5TS-2,5 R7-EBS45, RS2090

Alesatore per fori ciechi – Diametro intermedio

Elica diritta, versione corta – Ø 1,461-9,960 mm / 0.057- 0.392"

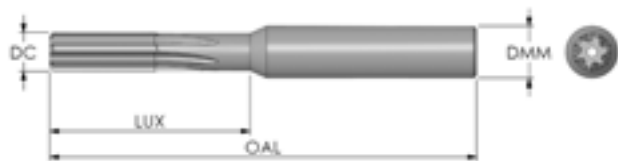

- Per la scelta della geometria, vedere le pagine 407-409
- Per i parametri di taglio raccomandati, vedere pagina(e) 414-421

Codice di ordinazione	DCN	DCX	LUX	DMM	OAL	Geometrie	Qualità							
	mm Inch	mm Inch	mm Inch	mm Inch	mm Inch		H15	RK2050	RX2000	RN2010	RM2020	RM2090	RS2090	
N5BS-1.461-XX.XXX	1,461 0.058	2,2 0.087	12,0 0.087	3,0 0.118	50,0 1.969	4	EB45 EB845 EB30 EB60...	<input type="checkbox"/>	<input type="checkbox"/>	<input type="checkbox"/>	<input type="checkbox"/>	<input type="checkbox"/>	<input type="checkbox"/>	<input type="checkbox"/>
N5BS-2.201-XX.XXX	2,201 0.087	2,96 0.117	17,0 0.117	3,0 0.118	50,0 1.969	4	EB45 EB845 EB30 EB60...	<input type="checkbox"/>	<input type="checkbox"/>	<input type="checkbox"/>	<input type="checkbox"/>	<input type="checkbox"/>	<input type="checkbox"/>	<input type="checkbox"/>
N5BS-2.961-XX.XXX	2,961 0.117	3,46 0.136	21,0 0.136	4,0 0.157	50,0 1.969	4	EB45 EB845 EB30 EB60...	<input type="checkbox"/>	<input type="checkbox"/>	<input type="checkbox"/>	<input type="checkbox"/>	<input type="checkbox"/>	<input type="checkbox"/>	<input type="checkbox"/>
N5BS-3.461-XX.XXX	3,461 0.136	3,96 0.156	23,0 0.156	4,0 0.157	50,0 1.969	4	EB45 EB845 EB30 EB60...	<input type="checkbox"/>	<input type="checkbox"/>	<input type="checkbox"/>	<input type="checkbox"/>	<input type="checkbox"/>	<input type="checkbox"/>	<input type="checkbox"/>
N5BS-3.961-XX.XXX	3,961 0.156	4,96 0.195	28,0 0.195	5,0 0.197	55,0 2.165	4	EB45 EB845 EB30 EB60...	<input type="checkbox"/>	<input type="checkbox"/>	<input type="checkbox"/>	<input type="checkbox"/>	<input type="checkbox"/>	<input type="checkbox"/>	<input type="checkbox"/>
N5BS-4.961-XX.XXX	4,961 0.195	5,96 0.235	28,0 0.235	6,0 0.236	55,0 2.165	4	EB45 EB845 EB30 EB60...	<input type="checkbox"/>	<input type="checkbox"/>	<input type="checkbox"/>	<input type="checkbox"/>	<input type="checkbox"/>	<input type="checkbox"/>	<input type="checkbox"/>
N5BS-5.961-XX.XXX	5,961 0.235	6,96 0.274	30,0 0.274	8,0 0.315	65,0 2.559	6	EB45 EB845 EB30 EB60...	<input type="checkbox"/>	<input type="checkbox"/>	<input type="checkbox"/>	<input type="checkbox"/>	<input type="checkbox"/>	<input type="checkbox"/>	<input type="checkbox"/>
N5BS-6.961-XX.XXX	6,961 0.274	7,96 0.313	31,0 0.313	8,0 0.315	65,0 2.559	-	EB45 EB845 EB30 EB60...	<input type="checkbox"/>	<input type="checkbox"/>	<input type="checkbox"/>	<input type="checkbox"/>	<input type="checkbox"/>	<input type="checkbox"/>	<input type="checkbox"/>
N5BS-7.961-XX.XXX	7,961 0.313	9,96 0.392	40,0 0.392	10,0 0.394	75,0 2.953	6	EB45 EB845 EB30 EB60...	<input type="checkbox"/>	<input type="checkbox"/>	<input type="checkbox"/>	<input type="checkbox"/>	<input type="checkbox"/>	<input type="checkbox"/>	<input type="checkbox"/>

☐ = Prodotto standard non presente a magazzino

Nota: Quando si ordinano alesatori Nanojet per diametri intermedi, indicare il diametro e la tolleranza del foro da alesare.

Esempio d'ordine: N5BS-8,084/8, 100-EB30, RK2050

Parametri di taglio – N5TS/N5BS...-EB45 misure metriche

SMG		a_p (°)		f		v_c								
		z=4	z=6	z=4	z=6	H15	CP20	RX2000	RK2050	RN2010	RM2020	RM2090	RS2090	
Introduzione	P1	NF/NS-EB45	0,10-0,15	0,1-0,20	0,10-0,30	0,20-0,60	25 (15-30)	60 (30-100)	80 (30-150)	-	-	-	-	-
	P2	NF/NS-EB45	0,10-0,15	0,1-0,20	0,10-0,30	0,20-0,60	25 (15-30)	60 (30-100)	80 (30-150)	-	-	-	-	-
	P3	NF/NS-EB45	0,10-0,15	0,1-0,20	0,10-0,30	0,20-0,60	25 (15-30)	60 (30-100)	80 (30-150)	-	-	-	-	-
	P4	NF/NS-EB45	0,10-0,15	0,1-0,20	0,10-0,20	0,20-0,50	20 (10-25)	50 (30-80)	60 (30-120)	-	-	-	-	-
	P5	NF/NS-EB45	0,10-0,15	0,1-0,20	0,10-0,20	0,20-0,50	20 (10-25)	50 (30-80)	60 (30-120)	-	-	-	-	-
	P6	NF/NS-EB45	0,10-0,15	0,1-0,20	0,10-0,20	0,20-0,50	20 (10-25)	50 (30-80)	60 (30-120)	-	-	-	-	-
	P7	NF/NS-EB45	0,10-0,15	0,1-0,20	0,10-0,20	0,20-0,50	20 (10-25)	50 (30-80)	60 (30-120)	-	-	-	-	-
	P8	NF/NS-EB45	0,10-0,15	0,1-0,20	0,10-0,20	0,20-0,50	15 (10-20)	35 (20-60)	40 (20-80)	-	-	-	-	-
Foratura	P11	NF/NS-EB45	0,10-0,15	0,1-0,20	0,10-0,20	0,20-0,50	15 (10-20)	35 (20-60)	40 (20-80)	-	-	-	-	-
	P12	NF/NS-EB45	0,10-0,15	0,1-0,20	0,10-0,20	0,20-0,50	12 (8-15)	25 (15-45)	30 (15-65)	-	-	-	-	-
	M1	NF/NS-EB45	0,08-0,15	0,10-0,15	0,10-0,20	0,20-0,50	12 (9-15)	25 (15-40)	35 (20-60)	-	-	25 (15-40)	40 (20-60)	-
	M2	NF/NS-EB45	0,08-0,15	0,10-0,15	0,10-0,20	0,20-0,50	-	25 (15-40)	35 (20-60)	-	-	25 (15-40)	40 (20-60)	-
	M3	NF/NS-EB45	0,08-0,15	0,10-0,15	0,10-0,20	0,20-0,50	-	25 (15-40)	35 (20-60)	-	-	25 (15-40)	40 (20-60)	-
Alesatura	M4	NF/NS-EB45	0,08-0,15	0,10-0,15	0,10-0,20	0,20-0,50	-	20 (10-30)	25 (15-40)	-	-	25 (10-30)	30 (15-40)	-
	M5	NF/NS-EB45	0,08-0,15	0,10-0,15	0,10-0,20	0,20-0,50	-	20 (10-30)	25 (15-40)	-	-	25 (10-30)	30 (15-40)	-
	K1	NF/NS-EB45	0,10-0,20	0,10-0,25	0,10-0,30	0,20-0,60	25 (15-30)	60 (40-100)	80 (30-150)	90 (35-170)	-	-	-	-
	K2	NF/NS-EB45	0,10-0,20	0,10-0,25	0,10-0,30	0,20-0,60	-	25 (20-40)	40 (30-70)	45 (35-80)	-	-	-	-
	K3	NF/NS-EB45	0,10-0,20	0,10-0,25	0,10-0,30	0,20-0,60	25 (15-30)	60 (40-100)	80 (30-150)	90 (35-170)	-	-	-	-
	K4	NF/NS-EB45	0,10-0,20	0,10-0,25	0,10-0,30	0,20-0,60	25 (15-30)	45 (30-70)	70 (40-120)	80 (45-135)	-	-	-	-
	K5	NF/NS-EB45	0,10-0,20	0,10-0,25	0,10-0,30	0,20-0,60	25 (15-30)	45 (30-70)	70 (40-120)	80 (45-135)	-	-	-	-
Barenatura	K6	NF/NS-EB45	0,10-0,20	0,10-0,25	0,10-0,30	0,20-0,60	-	60 (40-100)	80 (30-150)	90 (35-170)	-	-	-	-
	K7	NF/NS-EB45	0,10-0,20	0,10-0,25	0,10-0,30	0,20-0,60	-	60 (40-100)	80 (30-150)	90 (35-170)	-	-	-	-
	N1	NF/NS-EB45	0,10-0,20	0,10-0,30	0,10-0,30	0,20-0,60	50 (20-80)	-	80 (30-150)	-	50 (20-80)	-	-	-
	N2	NF/NS-EB45	0,10-0,20	0,10-0,30	0,10-0,30	0,20-0,60	50 (20-80)	-	80 (30-150)	-	50 (20-80)	-	-	-
	N3	NF/NS-EB45	0,10-0,20	0,10-0,30	0,10-0,30	0,20-0,60	50 (20-80)	-	80 (30-150)	-	50 (20-80)	-	-	-
	N4	NF/NS-EB45	0,10-0,20	0,10-0,30	0,10-0,30	0,20-0,60	50 (20-80)	-	80 (30-150)	-	50 (20-80)	-	-	-
	S1	NF/NS-EB45	0,08-0,15	0,10-0,15	0,10-0,20	0,20-0,30	-	15 (8-20)	20 (10-25)	-	-	-	-	20 (10-25)
S2	NF/NS-EB45	0,08-0,15	0,10-0,15	0,10-0,20	0,20-0,30	-	15 (8-20)	20 (10-25)	-	-	-	-	20 (10-25)	
S3	NF/NS-EB45	0,08-0,15	0,10-0,15	0,10-0,20	0,20-0,30	-	15 (8-20)	20 (10-25)	-	-	-	-	25 (10-25)	
S11	NF/NS-EB45	0,08-0,15	0,10-0,15	0,10-0,20	0,20-0,30	20 (15-30)	30 (15-40)	40 (20-50)	-	-	-	-	30 (20-50)	
S12	NF/NS-EB45	0,08-0,15	0,10-0,15	0,10-0,20	0,20-0,30	20 (15-30)	30 (15-40)	40 (20-50)	-	-	-	-	30 (20-50)	
S13	NF/NS-EB45	0,08-0,15	0,10-0,15	0,10-0,20	0,20-0,30	20 (15-30)	30 (15-40)	40 (20-50)	-	-	-	-	30 (20-50)	

La tabella continua alla pagina successiva.

Parametri di taglio – N5TS/N5BS...-EB45 misure metriche

SMG		$a_p (\varnothing)$		f		v_c							
		z=4	z=6	z=4	z=6	H15	CP20	RX2000	RK2050	RN2010	RM2020	RM2090	RS2090
H3	NF/NS-EB45	0,08-0,15	0,10-0,15	0,10-0,20	0,20-0,30	-	-	10 (8-15)	-	-	-	-	-
H5	NF/NS-EB45	0,08-0,15	0,10-0,15	0,10-0,20	0,20-0,30	-	-	10 (8-15)	-	-	-	-	-
H7	NF/NS-EB45	0,08-0,15	0,10-0,15	0,10-0,20	0,20-0,30	-	-	10 (8-15)	-	-	-	-	-
H8	NF/NS-EB45	0,08-0,15	0,10-0,15	0,10-0,20	0,20-0,30	-	-	10 (8-15)	-	-	-	-	-
H11	NF/NS-EB45	0,08-0,15	0,10-0,15	0,10-0,20	0,20-0,30	-	-	10 (8-15)	-	-	-	-	-
H12	NF/NS-EB45	0,08-0,15	0,10-0,15	0,10-0,20	0,20-0,30	-	-	10 (8-15)	-	-	-	-	-
H21	NF/NS-EB45	0,08-0,15	0,10-0,15	0,10-0,20	0,20-0,30	-	-	10 (8-15)	-	-	-	-	-
H31	NF/NS-EB45	0,08-0,15	0,10-0,15	0,10-0,20	0,20-0,30	-	-	10 (8-15)	-	-	-	-	-
PM1	NF/NS-EB45	0,10-0,15	0,1-0,20	0,10-0,20	0,20-0,50	-	50 (30-80)	70 (40-100)	-	-	-	-	-
PM2	NF/NS-EB45	0,10-0,15	0,1-0,20	0,10-0,20	0,20-0,50	-	50 (30-80)	70 (40-100)	-	-	-	-	-
PM3	NF/NS-EB45	0,10-0,15	0,1-0,20	0,10-0,20	0,20-0,50	-	50 (30-80)	70 (40-100)	-	-	-	-	-
TS1	NF/NS-EB45	0,10-0,15	0,1-0,20	0,10-0,30	0,20-0,60	20 (15-25)	-	40 (20-60)	-	-	-	-	-
TS2	NF/NS-EB45	0,10-0,15	0,1-0,20	0,10-0,30	0,20-0,60	20 (15-25)	-	40 (20-60)	-	-	-	-	-
TS3	NF/NS-EB45	0,10-0,15	0,1-0,20	0,10-0,30	0,20-0,60	20 (15-25)	-	40 (20-60)	-	-	-	-	-
TS4	NF/NS-EB45	0,10-0,15	0,1-0,20	0,10-0,30	0,20-0,60	20 (15-25)	-	40 (20-60)	-	-	-	-	-
TP1	NF/NS-EB45	0,10-0,15	0,1-0,20	0,10-0,30	0,20-0,60	20 (15-25)	-	40 (20-60)	-	-	-	-	-
TP2	NF/NS-EB45	0,10-0,15	0,1-0,20	0,10-0,30	0,20-0,60	20 (15-25)	-	40 (20-60)	-	-	-	-	-
TP3	NF/NS-EB45	0,10-0,15	0,1-0,20	0,10-0,30	0,20-0,60	20 (15-25)	-	40 (20-60)	-	-	-	-	-
TP4	NF/NS-EB45	0,10-0,15	0,1-0,20	0,10-0,30	0,20-0,60	20 (15-25)	-	40 (20-60)	-	-	-	-	-
GR1	NF/NS-EB45	0,10-0,15	0,1-0,20	0,10-0,30	0,20-0,60	40 (80-20)	-	60 (30-120)	-	-	-	-	-

SMG = Gruppo materiale Seco

a_p = mm

f = mm/rev

v_c = m/min

Tutti i parametri di taglio sono valori di partenza

Introduzione

Foratura

Alesatura

Barenatura

Allegato

Parametri di taglio – N5TS/N5BS...-EB45 pollici

SMG		a_p (°)		f		v_c								
		z=4	z=6	z=4	z=6	H15	CP20	RX2000	RK2050	RN2010	RM2020	RM2090	RS2090	
Introduzione	P1	NF/NS-EB45	0.004-0.006	0.004-0.008	0.004-0.012	0.008-0.024	80 (50-100)	195 (100-330)	260 (100-490)	-	-	-	-	-
	P2	NF/NS-EB45	0.004-0.006	0.004-0.008	0.004-0.012	0.008-0.024	80 (50-100)	195 (100-330)	260 (100-490)	-	-	-	-	-
	P3	NF/NS-EB45	0.004-0.006	0.004-0.008	0.004-0.012	0.008-0.024	80 (50-100)	195 (100-330)	260 (100-490)	-	-	-	-	-
	P4	NF/NS-EB45	0.004-0.006	0.004-0.008	0.004-0.008	0.008-0.020	65 (35-80)	165 (100-260)	195 (100-395)	-	-	-	-	-
	P5	NF/NS-EB45	0.004-0.006	0.004-0.008	0.004-0.008	0.008-0.020	65 (35-80)	165 (100-260)	195 (100-395)	-	-	-	-	-
	P6	NF/NS-EB45	0.004-0.006	0.004-0.008	0.004-0.008	0.008-0.020	65 (35-80)	165 (100-260)	195 (100-395)	-	-	-	-	-
	P7	NF/NS-EB45	0.004-0.006	0.004-0.008	0.004-0.008	0.008-0.020	65 (35-80)	165 (100-260)	195 (100-395)	-	-	-	-	-
	P8	NF/NS-EB45	0.004-0.006	0.004-0.008	0.004-0.008	0.008-0.020	50 (35-65)	115 (65-195)	130 (65-260)	-	-	-	-	-
Foratura	P11	NF/NS-EB45	0.004-0.006	0.004-0.008	0.004-0.008	0.008-0.020	50 (35-65)	115 (65-195)	130 (65-260)	-	-	-	-	-
	P12	NF/NS-EB45	0.004-0.006	0.004-0.008	0.004-0.008	0.008-0.020	40 (25-50)	80 (50-150)	100 (50-215)	-	-	-	-	-
	M1	NF/NS-EB45	0.003-0.006	0.004-0.006	0.004-0.008	0.008-0.020	40 (30-50)	80 (50-130)	115 (65-195)	-	-	80 (50-130)	130 (65-195)	-
	M2	NF/NS-EB45	0.003-0.006	0.004-0.006	0.004-0.008	0.008-0.020	-	80 (50-130)	115 (65-195)	-	-	80 (50-130)	130 (65-195)	-
	M3	NF/NS-EB45	0.003-0.006	0.004-0.006	0.004-0.008	0.008-0.020	-	80 (50-130)	115 (65-195)	-	-	80 (50-130)	130 (65-195)	-
Alesatura	M4	NF/NS-EB45	0.003-0.006	0.004-0.006	0.004-0.008	0.008-0.020	-	65 (35-100)	80 (50-130)	-	-	65 (35-100)	100 (50-130)	-
	M5	NF/NS-EB45	0.003-0.006	0.004-0.006	0.004-0.008	0.008-0.020	-	65 (35-100)	80 (50-130)	-	-	65 (35-100)	100 (50-130)	-
	K1	NF/NS-EB45	0.004-0.008	0.004-0.010	0.004-0.012	0.008-0.024	80 (50-100)	195 (130-330)	260 (100-490)	290 (110-550)	-	-	-	-
	K2	NF/NS-EB45	0.004-0.008	0.004-0.010	0.004-0.012	0.008-0.024	-	80 (65-130)	130 (100-230)	145 (110-260)	-	-	-	-
	K3	NF/NS-EB45	0.004-0.008	0.004-0.010	0.004-0.012	0.008-0.024	80 (50-100)	195 (130-330)	260 (100-490)	290 (110-550)	-	-	-	-
	K4	NF/NS-EB45	0.004-0.008	0.004-0.010	0.004-0.012	0.008-0.024	80 (50-100)	150 (100-230)	230 (130-395)	260 (145-440)	-	-	-	-
	K5	NF/NS-EB45	0.004-0.008	0.004-0.010	0.004-0.012	0.008-0.024	80 (50-100)	150 (100-230)	230 (130-395)	260 (145-440)	-	-	-	-
	K6	NF/NS-EB45	0.004-0.008	0.004-0.010	0.004-0.012	0.008-0.024	-	195 (130-330)	260 (100-490)	290 (110-550)	-	-	-	-
	K7	NF/NS-EB45	0.004-0.008	0.004-0.010	0.004-0.012	0.008-0.024	-	195 (130-330)	260 (100-490)	290 (110-550)	-	-	-	-
	N1	NF/NS-EB45	0.004-0.787	0.004-0.012	0.004-0.012	0.008-0.024	165 (65-260)	-	260 (100-490)	-	165 (65-260)	-	-	-
	N2	NF/NS-EB45	0.004-0.787	0.004-0.012	0.004-0.012	0.008-0.024	165 (65-260)	-	260 (100-490)	-	165 (65-260)	-	-	-
	N3	NF/NS-EB45	0.004-0.787	0.004-0.012	0.004-0.012	0.008-0.024	165 (65-260)	-	260 (100-490)	-	165 (65-260)	-	-	-
	N4	NF/NS-EB45	0.004-0.787	0.004-0.012	0.004-0.012	0.008-0.024	165 (65-260)	-	260 (100-490)	-	165 (65-260)	-	-	-
Barenatura	S1	NF/NS-EB45	0.003-0.006	0.004-0.006	0.004-0.008	0.008-0.012	-	50 (25-65)	65 (35-80)	-	-	-	65 (35-80)	
	S2	NF/NS-EB45	0.003-0.006	0.004-0.006	0.004-0.008	0.008-0.012	-	50 (25-65)	65 (35-80)	-	-	-	65 (35-80)	
	S3	NF/NS-EB45	0.003-0.006	0.004-0.006	0.004-0.008	0.008-0.012	-	50 (25-65)	65 (35-80)	-	-	-	80 (35-80)	
	S11	NF/NS-EB45	0.003-0.006	0.004-0.006	0.004-0.008	0.008-0.012	65 (50-100)	100 (50-130)	130 (65-165)	-	-	-	100 (65-165)	
	S12	NF/NS-EB45	0.003-0.006	0.004-0.006	0.004-0.008	0.008-0.012	65 (50-100)	100 (50-130)	130 (65-165)	-	-	-	100 (65-165)	
	S13	NF/NS-EB45	0.003-0.006	0.004-0.006	0.004-0.008	0.008-0.012	65 (50-100)	100 (50-130)	130 (65-165)	-	-	-	100 (65-165)	

La tabella continua alla pagina successiva.

Parametri di taglio – N5TS/N5BS...-EB45 pollici

SMG		a_p (°)		f		v_c							
		z=4	z=6	z=4	z=6	H15	CP20	RX2000	RK2050	RN2010	RM2020	RM2090	RS2090
H3	NF/NS-EB45	0.003-0.006	0.004-0.006	0.004-0.008	0.008-0.012	-	-	35 (25-50)	-	-	-	-	-
H5	NF/NS-EB45	0.003-0.006	0.004-0.006	0.004-0.008	0.008-0.012	-	-	35 (25-50)	-	-	-	-	-
H7	NF/NS-EB45	0.003-0.006	0.004-0.006	0.004-0.008	0.008-0.012	-	-	35 (25-50)	-	-	-	-	-
H8	NF/NS-EB45	0.003-0.006	0.004-0.006	0.004-0.008	0.008-0.012	-	-	35 (25-50)	-	-	-	-	-
H11	NF/NS-EB45	0.003-0.006	0.004-0.006	0.004-0.008	0.008-0.012	-	-	35 (25-50)	-	-	-	-	-
H12	NF/NS-EB45	0.003-0.006	0.004-0.006	0.004-0.008	0.008-0.012	-	-	35 (25-50)	-	-	-	-	-
H21	NF/NS-EB45	0.003-0.006	0.004-0.006	0.004-0.008	0.008-0.012	-	-	35 (25-50)	-	-	-	-	-
H31	NF/NS-EB45	0.003-0.006	0.004-0.006	0.004-0.008	0.008-0.012	-	-	35 (25-50)	-	-	-	-	-
PM1	NF/NS-EB45	0.004-0.006	0.004-0.008	0.004-0.008	0.008-0.020	-	165 (100-260)	230 (130-350)	-	-	-	-	-
PM2	NF/NS-EB45	0.004-0.006	0.004-0.008	0.004-0.008	0.008-0.020	-	165 (100-260)	230 (130-350)	-	-	-	-	-
PM3	NF/NS-EB45	0.004-0.006	0.004-0.008	0.004-0.008	0.008-0.020	-	165 (100-260)	230 (130-350)	-	-	-	-	-
TS1	NF/NS-EB45	0.004-0.006	0.004-0.008	0.004-0.012	0.008-0.024	65 (50-80)	-	130 (65-195)	-	-	-	-	-
TS2	NF/NS-EB45	0.004-0.006	0.004-0.008	0.004-0.012	0.008-0.024	65 (50-80)	-	130 (65-195)	-	-	-	-	-
TS3	NF/NS-EB45	0.004-0.006	0.004-0.008	0.004-0.012	0.008-0.024	65 (50-80)	-	130 (65-195)	-	-	-	-	-
TS4	NF/NS-EB45	0.004-0.006	0.004-0.008	0.004-0.012	0.008-0.024	65 (50-80)	-	130 (65-195)	-	-	-	-	-
TP1	NF/NS-EB45	0.004-0.006	0.004-0.008	0.004-0.012	0.008-0.024	65 (50-80)	-	130 (65-195)	-	-	-	-	-
TP2	NF/NS-EB45	0.004-0.006	0.004-0.008	0.004-0.012	0.008-0.024	65 (50-80)	-	130 (65-195)	-	-	-	-	-
TP3	NF/NS-EB45	0.004-0.006	0.004-0.008	0.004-0.012	0.008-0.024	65 (50-80)	-	130 (65-195)	-	-	-	-	-
TP4	NF/NS-EB45	0.004-0.006	0.004-0.008	0.004-0.012	0.008-0.024	65 (50-80)	-	130 (65-195)	-	-	-	-	-
GR1	NF/NS-EB45	0.004-0.006	0.004-0.008	0.004-0.012	0.008-0.024	130 (65-260)	-	195 (100-395)	-	-	-	-	-

SMG = Gruppo materiale Seco

a_p = inch

f = in/rev

v_c = sf/min

Tutti i parametri di taglio sono valori di partenza

Introduzione

Foratura

Alesatura

Barenatura

Allegato

Parametri di taglio – N5TS/N5BS...-EB845 misure metriche

SMG		a_p (°)		f		v_c						
		z=4	z=6	z=4	z=6	H15	CP20	RX2000	RK2050	RM2020	RM2090	RS2090
Introduzione	P3	0,10 -0,15	0,1 -0,20	0,10 -0,30	0,20 -0,60	-	60 (30-100)	80 (30-150)	-	-	-	-
	P4	0,10 -0,15	0,1 -0,20	0,10 -0,20	0,20 -0,50	-	50 (30-80)	60 (30-120)	-	-	-	-
	P5	0,10 -0,15	0,1 -0,20	0,10 -0,20	0,20 -0,50	20 (10-25)	50 (30-80)	60 (30-120)	-	-	-	-
	P6	0,10 -0,15	0,1 -0,20	0,10 -0,20	0,20 -0,50	20 (10-25)	50 (30-80)	60 (30-120)	-	-	-	-
	P7	0,10 -0,15	0,1 -0,20	0,10 -0,20	0,20 -0,50	20 (10-25)	50 (30-80)	60 (30-120)	-	-	-	-
	P8	0,10 -0,15	0,1 -0,20	0,10 -0,20	0,20 -0,50	15 (10-20)	35 (20-60)	40 (20-80)	-	-	-	-
	P11	0,10 -0,15	0,1 -0,20	0,10 -0,20	0,20 -0,50	15 (10-20)	35 (20-60)	40 (20-80)	-	-	-	-
	P12	0,10 -0,15	0,1 -0,20	0,10 -0,20	0,20 -0,50	12 (8-15)	25 (15-45)	30 (15-65)	-	-	-	-
Foratura	M1	0,08 -0,15	0,10 -0,15	0,10 -0,20	0,20 -0,50	12 (9-15)	25 (15-45)	35 (20-60)	-	25 (15-40)	40 (20-60)	-
	M2	0,08 -0,15	0,10 -0,15	0,10 -0,20	0,20 -0,50	-	25 (15-45)	35 (20-60)	-	25 (15-40)	40 (20-60)	-
	M3	0,08 -0,15	0,10 -0,15	0,10 -0,20	0,20 -0,50	-	25 (15-45)	35 (20-60)	-	25 (15-40)	40 (20-60)	-
	M4	0,08 -0,15	0,10 -0,15	0,10 -0,20	0,20 -0,50	-	20 (10-30)	25 (15-40)	-	25 (10-30)	30 (15-40)	-
	M5	0,08 -0,15	0,10 -0,15	0,10 -0,20	0,20 -0,50	-	20 (10-30)	25 (15-40)	-	25 (10-30)	30 (15-40)	-
Alesatura	K1	0,10 -0,20	0,10 -0,25	0,10 -0,30	0,20 -0,60	25 (15-30)	60 (40-100)	80 (30-150)	90 (35-170)	-	-	-
	K2	0,10 -0,20	0,10 -0,25	0,10 -0,30	0,20 -0,60	-	25 (20-40)	40 (30-70)	45 (35-80)	-	-	-
	K3	0,10 -0,20	0,10 -0,25	0,10 -0,30	0,20 -0,60	25 (15-30)	60 (40-100)	80 (30-150)	90 (35-170)	-	-	-
	K4	0,10 -0,20	0,10 -0,25	0,10 -0,30	0,20 -0,60	25 (15-30)	45 (30-70)	70 (40-120)	80 (30-150)	-	-	-
	K5	0,10 -0,20	0,10 -0,25	0,10 -0,30	0,20 -0,60	25 (15-30)	45 (30-70)	70 (40-120)	80 (45-135)	-	-	-
	K6	0,10 -0,20	0,10 -0,25	0,10 -0,30	0,20 -0,60	-	60 (40-100)	80 (30-150)	90 (35-170)	-	-	-
	K7	0,10 -0,20	0,10 -0,25	0,10 -0,30	0,20 -0,60	-	60 (40-100)	80 (30-150)	90 (35-170)	-	-	-
	S1	0,08 -0,15	0,10 -0,15	0,10 -0,20	0,20 0,30	-	15 (8-20)	20 (10-25)	-	-	-	20 (10-25)
	S2	0,08 -0,15	0,10 -0,15	0,10 -0,20	0,20 0,30	-	15 (8-20)	20 (10-25)	-	-	-	20 (10-25)
	S3	0,08 -0,15	0,10 -0,15	0,10 -0,20	0,20 0,30	-	15 (8-20)	20 (10-25)	-	-	-	25 (10-25)
	S11	0,08 -0,15	0,10 -0,15	0,10 -0,20	0,20 0,30	20 (15-30)	30 (15-40)	40 (20-50)	-	-	-	30 (20-50)
	S12	0,08 -0,15	0,10 -0,15	0,10 -0,20	0,20 0,30	20 (15-30)	30 (15-40)	40 (20-50)	-	-	-	30 (20-50)
	S13	0,08 -0,15	0,10 -0,15	0,10 -0,20	0,20 0,30	20 (15-30)	30 (15-40)	40 (20-50)	-	-	-	30 (20-50)
Barenatura	H3	0,08 -0,15	0,10 -0,15	0,10 -0,20	0,20 0,30	-	-	10 (8-15)	-	-	-	-
	H5	0,08 -0,15	0,10 -0,15	0,10 -0,20	0,20 0,30	-	-	10 (8-15)	-	-	-	-
	H7	0,08 -0,15	0,10 -0,15	0,10 -0,20	0,20 0,30	-	-	10 (8-15)	-	-	-	-
	H8	0,08 -0,15	0,10 -0,15	0,10 -0,20	0,20 0,30	-	-	10 (8-15)	-	-	-	-
	H11	0,08 -0,15	0,10 -0,15	0,10 -0,20	0,20 0,30	-	-	10 (8-15)	-	-	-	-
	H12	0,08 -0,15	0,10 -0,15	0,10 -0,20	0,20 0,30	-	-	10 (8-15)	-	-	-	-
	H21	0,08 -0,15	0,10 -0,15	0,10 -0,20	0,20 0,30	-	-	10 (8-15)	-	-	-	-
	H31	0,08 -0,15	0,10 -0,15	0,10 -0,20	0,20 0,30	-	-	10 (8-15)	-	-	-	-
	Allegato	PM1	0,10 -0,15	0,1 -0,20	0,10 -0,20	0,20 -0,50	-	50 (30-80)	70 (40-100)	-	-	-
PM2		0,10 -0,15	0,1 -0,20	0,10 -0,20	0,20 -0,50	-	50 (30-80)	70 (40-100)	-	-	-	-
PM3		0,10 -0,15	0,1 -0,20	0,10 -0,20	0,20 -0,50	-	50 (30-80)	70 (40-100)	-	-	-	-

SMG = Gruppo materiale Seco

a_p = mm

f = mm/rev

v_c = m/min

Tutti i parametri di taglio sono valori di partenza

Parametri di taglio – N5TS/N5BS...-EB845 pollici

SMG		a _p (°)		f		v _c						
		z=4	z=6	z=4	z=6	H15	CP20	RX2000	RK2050	RM2020	RM2090	RS2090
P3	NF/NS-EB845	0.004 -0.006	0.004 -0.008	0.004 -0.012	0.008 -0.024	-	195 (100-330)	260 (100-490)	-	-	-	-
P4	NF/NS-EB845	0.004 -0.006	0.004 -0.008	0.004 -0.008	0.008 -0.020	-	165 (100-260)	195 (100-395)	-	-	-	-
P5	NF/NS-EB845	0.004 -0.006	0.004 -0.008	0.004 -0.008	0.008 -0.020	65 (35-80)	165 (100-260)	195 (100-395)	-	-	-	-
P6	NF/NS-EB845	0.004 -0.006	0.004 -0.008	0.004 -0.008	0.008 -0.020	65 (35-80)	165 (100-260)	195 (100-395)	-	-	-	-
P7	NF/NS-EB845	0.004 -0.006	0.004 -0.008	0.004 -0.008	0.008 -0.020	65 (35-80)	165 (100-260)	195 (100-395)	-	-	-	-
P8	NF/NS-EB845	0.004 -0.006	0.004 -0.008	0.004 -0.008	0.008 -0.020	50 (35-65)	115 (65-195)	130 (65-260)	-	-	-	-
P11	NF/NS-EB845	0.004 -0.006	0.004 -0.008	0.004 -0.008	0.008 -0.020	50 (35-65)	115 (65-195)	130 (65-260)	-	-	-	-
P12	NF/NS-EB845	0.004 -0.006	0.004 -0.008	0.004 -0.008	0.008 -0.020	40 (25-50)	80 (50-150)	100 (50-125)	-	-	-	-
M1	NF/NS-EB845	0.003 -0.006	0.004 -0.006	0.004 -0.008	0.008 -0.02	40 (30-50)	80 (50-150)	115 (65-200)	-	80 (50-130)	130 (65-195)	-
M2	NF/NS-EB845	0.003 -0.006	0.004 -0.006	0.004 -0.008	0.008 -0.02	-	80 (50-150)	115 (65-200)	-	80 (50-130)	130 (65-195)	-
M3	NF/NS-EB845	0.003 -0.006	0.004 -0.006	0.004 -0.008	0.008 -0.02	-	80 (50-150)	115 (65-200)	-	80 (50-130)	130 (65-195)	-
M4	NF/NS-EB845	0.003 -0.006	0.004 -0.006	0.004 -0.008	0.008 -0.02	-	65 (30-100)	80 (50-135)	-	80 (35-100)	100 (50-130)	-
M5	NF/NS-EB845	0.003 -0.006	0.004 -0.006	0.004 -0.008	0.008 -0.02	-	65 (30-100)	80 (50-135)	-	80 (35-100)	100 (50-130)	-
K1	NF/NS-EB845	0.004 -0.008	0.004 -0.010	0.004 -0.012	0.008 -0.024	80 (50-100)	195 (130-330)	260 (100-490)	290 (110-550)	-	-	-
K2	NF/NS-EB845	0.004 -0.008	0.004 -0.010	0.004 -0.012	0.008 -0.024	-	80 (65-130)	130 (100-230)	145 (110-260)	-	-	-
K3	NF/NS-EB845	0.004 -0.008	0.004 -0.010	0.004 -0.012	0.008 -0.024	80 (50-100)	195 (130-330)	260 (100-490)	290 (110-550)	-	-	-
K4	NF/NS-EB845	0.004 -0.008	0.004 -0.010	0.004 -0.012	0.008 -0.024	80 (50-100)	150 (100-330)	230 (130-395)	260 (145-440)	-	-	-
K5	NF/NS-EB845	0.004 -0.008	0.004 -0.010	0.004 -0.012	0.008 -0.024	80 (50-100)	150 (100-330)	230 (130-395)	260 (145-440)	-	-	-
K6	NF/NS-EB845	0.004 -0.008	0.004 -0.010	0.004 -0.012	0.008 -0.024	-	195 (130-330)	260 (100-490)	290 (110-550)	-	-	-
K7	NF/NS-EB845	0.004 -0.008	0.004 -0.010	0.004 -0.012	0.008 -0.024	-	195 (130-330)	260 (100-490)	290 (110-550)	-	-	-
S1	NF/NS-EB845	0.003 -0.006	0.004 -0.006	0.004 -0.008	0.008 -0.012	-	50 (25-65)	65 (35-80)	-	-	-	65 (35-80)
S2	NF/NS-EB845	0.003 -0.006	0.004 -0.006	0.004 -0.008	0.008 -0.012	-	50 (25-65)	65 (35-80)	-	-	-	65 (35-80)
S3	NF/NS-EB845	0.003 -0.006	0.004 -0.006	0.004 -0.008	0.008 -0.012	-	50 (25-65)	65 (35-80)	-	-	-	65 (35-80)
S11	NF/NS-EB845	0.003 -0.006	0.004 -0.006	0.004 -0.008	0.008 -0.012	65 (50-100)	100 (50-130)	130 (65-165)	-	-	-	100 (65-165)
S12	NF/NS-EB845	0.003 -0.006	0.004 -0.006	0.004 -0.008	0.008 -0.012	65 (50-100)	100 (50-130)	130 (65-165)	-	-	-	100 (65-165)
S13	NF/NS-EB845	0.003 -0.006	0.004 -0.006	0.004 -0.008	0.008 -0.012	65 (50-100)	100 (50-130)	130 (65-165)	-	-	-	100 (65-165)
H3	NF/NS-EB845	0.003 -0.006	0.004 -0.006	0.004 -0.008	0.008 -0.012	-	-	35 (25-50)	-	-	-	-
H5	NF/NS-EB845	0.003 -0.006	0.004 -0.006	0.004 -0.008	0.008 -0.012	-	-	35 (25-50)	-	-	-	-
H7	NF/NS-EB845	0.003 -0.006	0.004 -0.006	0.004 -0.008	0.008 -0.012	-	-	35 (25-50)	-	-	-	-
H8	NF/NS-EB845	0.003 -0.006	0.004 -0.006	0.004 -0.008	0.008 -0.012	-	-	35 (25-50)	-	-	-	-
H11	NF/NS-EB845	0.003 -0.006	0.004 -0.006	0.004 -0.008	0.008 -0.012	-	-	35 (25-50)	-	-	-	-
H12	NF/NS-EB845	0.003 -0.006	0.004 -0.006	0.004 -0.008	0.008 -0.012	-	-	35 (25-50)	-	-	-	-
H21	NF/NS-EB845	0.003 -0.006	0.004 -0.006	0.004 -0.008	0.008 -0.012	-	-	35 (25-50)	-	-	-	-
H31	NF/NS-EB845	0.003 -0.006	0.004 -0.006	0.004 -0.008	0.008 -0.012	-	-	35 (25-50)	-	-	-	-
PM1	NF/NS-EB845	0.004 -0.006	0.004 -0.008	0.004 -0.008	0.008 -0.020	-	165 (100-260)	230 (130-350)	-	-	-	-
PM2	NF/NS-EB845	0.004 -0.006	0.004 -0.008	0.004 -0.008	0.008 -0.020	-	165 (100-260)	230 (130-350)	-	-	-	-
PM3	NF/NS-EB845	0.004 -0.006	0.004 -0.008	0.004 -0.008	0.008 -0.020	-	165 (100-260)	230 (130-350)	-	-	-	-

SMG = Gruppo materiale Seco

a_p = inch

f = in/rev

v_c = sf/min

Tutti i parametri di taglio sono valori di partenza

Introduzione

Foratura

Alesatura

Barenatura

Allegato

Parametri di taglio – N5TS/N5BS...-EB25/EB30 misure metriche

SMG		$a_p (\varnothing)$		f		v_c			
		z=4	z=6	z=4	z=6	H15	CP20	RX2000	RK2050
P1	NF/NS-EB25/EB30	0,10-0,15	0,1-0,20	0,3-0,9	0,5-1,2	25 (15-30)	60 (30-100)	80 (30-150)	-
P2	NF/NS-EB25/EB30	0,10-0,15	0,1-0,20	0,3-0,9	0,5-1,2	25 (15-30)	60 (30-100)	80 (30-150)	-
P3	NF/NS-EB25/EB30	0,10-0,15	0,1-0,20	0,3-0,9	0,5-1,2	25 (15-30)	60 (30-100)	80 (30-150)	-
P4	NF/NS-EB25/EB30	0,10-0,15	0,1-0,20	0,3-0,7	0,5-1	20 (10-25)	50 (30-80)	60 (30-120)	-
P5	NF/NS-EB25/EB30	0,10-0,15	0,1-0,20	0,3-0,7	0,5-1	20 (10-25)	50 (30-80)	60 (30-120)	-
P6	NF/NS-EB25/EB30	0,10-0,15	0,1-0,20	0,3-0,7	0,5-1	20 (10-25)	50 (30-80)	60 (30-120)	-
P7	NF/NS-EB25/EB30	0,10-0,15	0,1-0,20	0,3-0,7	0,5-1	20 (10-25)	50 (30-80)	60 (30-120)	-
M1	NF/NS-EB25/EB30	0,08-0,15	0,10-0,15	0,3-0,7	0,5-1	-	25 (15-40)	35 (20-60)	-
K1	NF/NS-EB25/EB30	0,10-0,20	0,10-0,25	0,3-0,9	0,5-1,2	25 (15-30)	60 (40-100)	80 (30-150)	90 (35-170)
K2	NF/NS-EB25/EB30	0,10-0,20	0,10-0,25	0,3-0,9	0,5-1,2	-	25 (20-40)	40 (30-70)	45 (35-80)
K3	NF/NS-EB25/EB30	0,10-0,20	0,10-0,25	0,3-0,9	0,5-1,2	25 (15-30)	60 (40-100)	80 (30-150)	90 (35-170)
K4	NF/NS-EB25/EB30	0,10-0,20	0,10-0,25	0,3-0,9	0,5-1,2	25 (15-30)	45 (30-70)	70 (40-120)	80 (45-135)
K5	NF/NS-EB25/EB30	0,10-0,20	0,10-0,25	0,3-0,9	0,5-1,2	25 (15-30)	45 (30-70)	70 (40-120)	80 (45-135)
K6	NF/NS-EB25/EB30	0,10-0,20	0,10-0,25	0,3-0,9	0,5-1,2	-	60 (40-100)	80 (30-150)	90 (35-170)
K7	NF/NS-EB25/EB30	0,10-0,20	0,10-0,25	0,3-0,9	0,5-1,2	-	60 (40-100)	80 (30-150)	90 (35-170)
N1	NF/NS-EB25/EB30	0,10-0,20	0,10-0,30	0,3-0,9	0,5-1,2	50 (20-80)	-	-	-
N2	NF/NS-EB25/EB30	0,10-0,20	0,10-0,30	0,3-0,9	0,5-1,2	50 (20-80)	-	-	-
N3	NF/NS-EB25/EB30	0,10-0,20	0,10-0,30	0,3-0,9	0,5-1,2	50 (20-80)	-	-	-
N11	NF/NS-EB25/EB30	0,10-0,20	0,10-0,30	0,3-0,9	0,5-1,2	50 (20-80)	-	-	-
PM1	NF/NS-EB25/EB30	0,10-0,15	0,1-0,20	0,3-0,9	0,5-1,2	-	50 (30-80)	70 (40-100)	-
PM2	NF/NS-EB25/EB30	0,10-0,15	0,1-0,20	0,3-0,9	0,5-1,2	-	50 (30-80)	70 (40-100)	-
PM3	NF/NS-EB25/EB30	0,10-0,15	0,1-0,20	0,3-0,9	0,5-1,2	-	50 (30-80)	70 (40-100)	-

SMG = Gruppo materiale Seco

a_p = mm

f = mm/rev

v_c = m/min

Tutti i parametri di taglio sono valori di partenza

Parametri di taglio – N5TS/N5BS...-EB25/EB30 pollici

SMG		$a_p (\varnothing)$		f		v_c			
		z=4	z=6	z=4	z=6	H15	CP20	RX2000	RK2050
P1	NF/NS-EB25/EB30	0.004-0.006	0.004-0.008	0.012-0.035	0.020-0.047	80 (50-100)	195 (100-330)	260 (100-490)	-
P2	NF/NS-EB25/EB30	0.004-0.006	0.004-0.008	0.012-0.035	0.020-0.047	80 (50-100)	195 (100-330)	260 (100-490)	-
P3	NF/NS-EB25/EB30	0.004-0.006	0.004-0.008	0.012-0.035	0.020-0.047	80 (50-100)	195 (100-330)	260 (100-490)	-
P4	NF/NS-EB25/EB30	0.004-0.006	0.004-0.008	0.012-0.028	0.020-0.039	65 (35-80)	165 (100-265)	195 (100-395)	-
P5	NF/NS-EB25/EB30	0.004-0.006	0.004-0.008	0.012-0.028	0.020-0.039	65 (35-80)	165 (100-265)	195 (100-395)	-
P6	NF/NS-EB25/EB30	0.004-0.006	0.004-0.008	0.012-0.028	0.020-0.039	65 (35-80)	165 (100-265)	195 (100-395)	-
P7	NF/NS-EB25/EB30	0.004-0.006	0.004-0.008	0.012-0.028	0.020-0.039	65 (35-80)	165 (100-265)	195 (100-395)	-
M1	NF/NS-EB25/EB30	0.003-0.006	0.004-0.006	0.012-0.028	0.020-0.039	-	80 (50-130)	115 (65-195)	-
K1	NF/NS-EB25/EB30	0.004-0.008	0.004-0.010	0.012-0.035	0.020-0.047	80 (50-100)	195 (130-330)	260 (100-490)	290 (110-550)
K2	NF/NS-EB25/EB30	0.004-0.008	0.004-0.010	0.012-0.035	0.020-0.047	-	80 (65-130)	130 (100-230)	145 (110-260)
K3	NF/NS-EB25/EB30	0.004-0.008	0.004-0.010	0.012-0.035	0.020-0.047	80 (50-100)	195 (130-330)	260 (100-490)	290 (110-550)
K4	NF/NS-EB25/EB30	0.004-0.008	0.004-0.010	0.012-0.035	0.020-0.047	80 (50-100)	150 (100-230)	230 (130-395)	260 (145-440)
K5	NF/NS-EB25/EB30	0.004-0.008	0.004-0.010	0.012-0.035	0.020-0.047	80 (50-100)	150 (100-230)	230 (130-395)	260 (145-440)
K6	NF/NS-EB25/EB30	0.004-0.008	0.004-0.010	0.012-0.035	0.020-0.047	-	195 (130-330)	260 (100-490)	290 (110-550)
K7	NF/NS-EB25/EB30	0.004-0.008	0.004-0.010	0.012-0.035	0.020-0.047	-	195 (130-330)	260 (100-490)	290 (110-550)
N1	NF/NS-EB25/EB30	0.004-0.787	0.004-0.012	0.012-0.035	0.020-0.047	165 (65-265)	-	-	-
N2	NF/NS-EB25/EB30	0.004-0.787	0.004-0.012	0.012-0.035	0.020-0.047	165 (65-265)	-	-	-
N3	NF/NS-EB25/EB30	0.004-0.787	0.004-0.012	0.012-0.035	0.020-0.047	165 (65-265)	-	-	-
N11	NF/NS-EB25/EB30	0.004-0.787	0.004-0.012	0.012-0.035	0.020-0.047	165 (65-265)	-	-	-
PM1	NF/NS-EB25/EB30	0.004-0.006	0.004-0.008	0.012-0.035	0.020-0.047	-	165 (100-265)	230 (130-330)	-
PM2	NF/NS-EB25/EB30	0.004-0.006	0.004-0.008	0.012-0.035	0.020-0.047	-	165 (100-265)	230 (130-330)	-
PM3	NF/NS-EB25/EB30	0.004-0.006	0.004-0.008	0.012-0.035	0.020-0.047	-	165 (100-265)	230 (130-330)	-

SMG = Gruppo materiale Seco

$a_p = inch$

f = in/rev

$v_c = sf/min$

Tutti i parametri di taglio sono valori di partenza

Introduzione

Foratura

Alesatura

Barenatura

Allegato

Istruzioni per la riaffilatura

Specifiche

Mola diamantata
Dimensione grana:
D6 per il 1° angolo di spoglia (β_1 - β_3)
D64 per il 2° angolo di spoglia (β_2)

Importante

La riaffilatura riduce il diametro dell'alesatore.
La riapplicazione del rivestimento può generare un aumento del diametro.
Errore di concentricità massimo sugli smussi di imbocco 10 μm (394 μin).

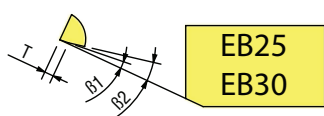

EB25
EB30

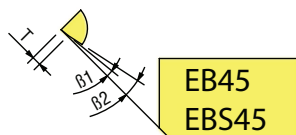

EB45
EBS45

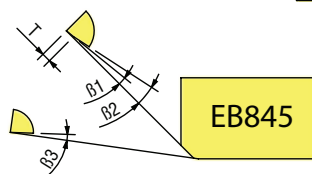

EB845

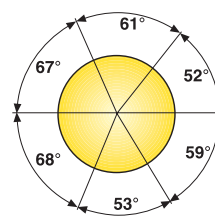
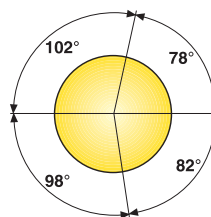
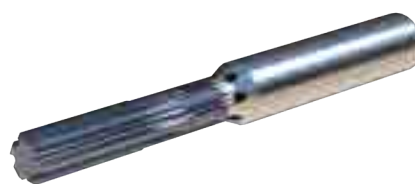

Nanojet \varnothing mm (pollici)	β_1	β_2	β_3	T mm (pollici)
1,461-2,460 (0.0575-0.0968")	8°	21°	8°	0,10 (0.004")
2,461-2,960 (0.0969-0.1165")	8°	18°	8°	0,10 (0.004")
2,961-9,960 (0.1166-0.3921")	8°	18°	8°	0,15 (0.006")



Bifix®

Gli alesatori a lama intercambiabile Bifix® offrono prestazioni di alta precisione su tutti i gruppi materiale

- Consente tolleranze tra 8 e 16 μm e una finitura superficiale fino a Ra 0,25 (RMS 12 micro/pollici)
- Le lame intercambiabili sono caratterizzate da due taglienti per lama
- Tre pattini di guida in cermet e a un accurato sistema di regolazione

Panoramica della gamma

		Gamma ∅	Profondità di alesatura	Tolleranza ∅ foro	Diametro intermedio	Finitura superficiale
Introduzione	SR80 Per fori passanti 	6,875-60,500 mm (0.2707-2.3819")	5-7 x D	IT 6	Disponibile tramite My Design	R _a 0,2-0,8 μm (R _a 8-31 μin)
Foratura	SR81 Per fori ciechi 	7,875-60,500 mm (0.3100-2.3819")	5-7 x D	IT 6-7	Disponibile tramite My Design	R _a 0,2-0,8 μm (R _a 8-31 μin)
	SR82 Per fori ciechi, versione corta 	7,875-60,500 mm (0.3100-2.3819")	3-5 x D	IT 6-7	Disponibile tramite My Design	R _a 0,2-0,8 μm (R _a 8-31 μin)

Alesatura

Barenatura

Allegato

Chiavi di codifica

Alesatori

Tipo di alesatore:

Tipo 80: Fori passanti

Tipo 81: Fori ciechi

Tipo 82: Fori ciechi, versione corta

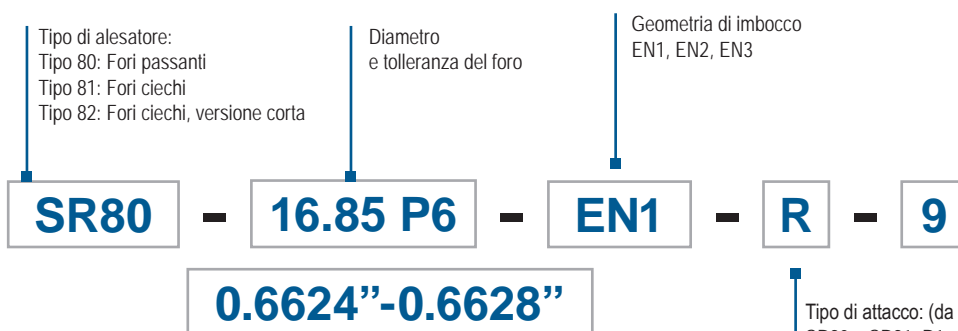

Tipo di attacco: (da specificare nella richiesta di alesatori speciali)
SR80 e SR81: R1 cilindrico senza piano è standard
SR82: R9 cilindrico con piano



Lame

Importante:

L'alesatore e la lama devono avere la stessa geometria d'imbocco.

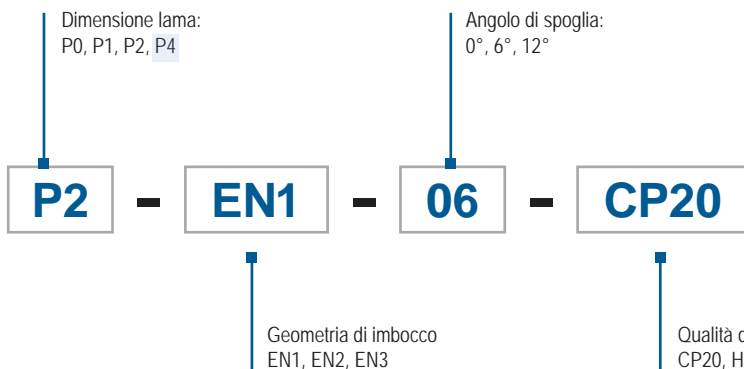

Montaggio e parametri di lavorazione

Utensile rotante

Massima eccentricità raccomandata: 0,02 mm (0,0008").
Si raccomanda un attacco di precisione: Attacco idraulico, porta pinze 5672 o calettamento termico.

Utensile non rotante

Utilizzare un attacco flottante Seco, vedere pagina 505-509.



Per un'evacuazione del truciolo ottimale

Orientamento consigliato della lama per utensili non rotanti (vedere disegno, vista della parte frontale degli utensili).

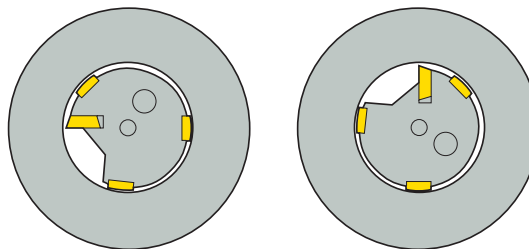

Requisiti del refrigerante

Per la massima durata utensile ed una buona qualità del foro, si devono soddisfare i seguenti requisiti relativi al refrigerante.
Si raccomanda l'adduzione del refrigerante attraverso l'utensile.
L'adduzione esterna è possibile se la profondità di alesatura è $< 2 \times D$.
Olio solubile di qualità con almeno il 40% di olio minerale. Per l'acciaio inossidabile si consiglia olio puro.
Filtrazione 30-50 μm (1200-2000 μin).
Volume minimo 0,5 l/min/mm (3,35 gal/min/pollici) nel diametro utensile.
Esempio: alesatore $\varnothing 10$, il volume minimo è 5 l/min (1,3 gal/min).



Dispositivo di regolazione

SF-60200-C160C190: Codice di ordinazione 02885396

- Posizione orizzontale
- Prima scelta per \varnothing minori di 60 mm (2,362")
- 2 indicatori
- \varnothing massimo utensile: 60,5 mm (2,382")
- Lunghezza massima utensile: 200 mm (7,874")



Sceita della geometria – Lame

Notare che la lama e l'alesatore devono avere la stessa geometria d'imbocco.

Qualità di metallo duro ed angolo di spoglia

Utilizzare le tabelle alle pagine 702-708 per classificare il materiale da lavorare in un gruppo materiale Seco.

Per scegliere la qualità di metallo duro e l'angolo di spoglia, consultare la tabella alle pagine 438-446.

Il programma lame è riportato alle pagine 436, 437.

EN1 – Applicazione	
<p>Massimo sovrametallo su \varnothing 0,5 mm (0,020")</p> <p>Finitura superficiale + R_a 0,3-0,8 μm (Finitura superficiale + R_a 12-31 μin)</p>	
EN2 – Imbocco corto	
<p>Massimo sovrametallo su \varnothing 0,3 mm (0,012")</p> <p>Finitura superficiale + R_a 0,4-1,2 μm (Finitura superficiale + R_a 16-47 μin)</p> <p>Velocità massima di avanzamento 0,2 mm/giro (0,008" pollici/giro).</p> <p>Da impiegarsi unicamente quando è richiesto un imbocco corto</p> <p>Adatto a spallamenti.</p>	
EN3 – Finitura superficiale accurata	
<p>Massimo sovrametallo su \varnothing 0,5 mm (0,020")</p> <p>Finitura superficiale + R_a 0,2-0,6 μm (Finitura superficiale + R_a 8-24 μin)</p> <p>Indicata per tutti i materiali eccetto alluminio.</p> <p>Da utilizzare quando R_a deve essere < 0,3-0,4 μm (12-16 μin)</p>	

Ottimizzazione / qualità

Utilizzare la seguente tabella per selezionare lame alternative in termini di maggior produttività o maggior sicurezza.

Introduzione

Foratura

Alesatura

Barenatura

Allegato

Selezione della lama

Dimensione lama	Acciaio	Acciaio inossidabile	Ghisa	Materiali non ferrosi	Alluminio	Resistenza all'usura ↔ Tenacità			Descrizione	
						Produttività	Versatilità	Sicurezza	Lama	Qualità
P0, P1, P2, P4										
	•		•	•	•			X	Pxx-ENx-00	H15
	•		•	•	•			X	Pxx-ENx-06	H15
	•	•		•	•			X	Pxx-ENx-12	H15
	•					X			Pxx-ENx-00	CP20
	•						X		Pxx-ENx-06	CP20
	•						X		Pxx-ENx-12	CP20
	•					X			Pxx-ENx-00	CP15
	•					X			Pxx-ENx-06	CP15
	•					X			Pxx-ENx-12	CP15

Qualità

	CP15	Rivestita Qualità rivestita resistente all'usura alternativa a CP20. Per l'ottimizzazione di ghisa e acciai. Anche per materiali non ferrosi. Ti(C, N)
	CP20	Rivestita Qualità rivestita versatile adatta per la maggior parte dei materiali da lavorare, tranne l'alluminio. TiN
	H15	Non rivestita Qualità micrograna tenace per tutti i materiali da lavorare. Adatta per operazioni di finitura, grazie all'affilatura del tagliente.

Per fori passanti \varnothing 7H6-26H6

Tipo di codolo R1, cilindrico senza piano, SR80

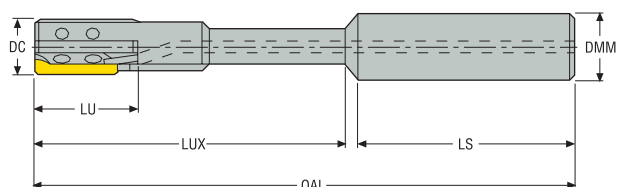

- Informazioni sulle lame alle pagine 436, 437
- Adduzione refrigerante interna
- Per i parametri di taglio raccomandati, vedere pagina(e) 438-446

Descrizione	DC	OAL	LS	LUX	LU	DMM	Dimensione lama
	mm	mm	mm	mm	mm	mm	
SR80-7H6-EN1	7	105	40	63	25	10	P0-EN1-xx
SR80-8H6-EN1	8	115	40	73	25	10	P0-EN1-xx
SR80-9H6-EN1	9	115	40	73	25	10	P1-EN1-xx
SR80-10H6-EN1	10	115	40	74	25	10	P1-EN1-xx
SR80-11H6-EN1	11	133	48	81	25	16	P1-EN1-xx
SR80-12H6-EN1	12	133	48	81	25	16	P1-EN1-xx
SR80-13H6-EN1	13	133	48	81	25	16	P2-EN1-xx
SR80-14H6-EN1	14	133	48	81	25	16	P2-EN1-xx
SR80-15H6-EN1	15	133	48	82	25	16	P2-EN1-xx
SR80-16H6-EN1	16	133	48	82	25	16	P2-EN1-xx
SR80-17H6-EN1	17	155	50	100	25	20	P2-EN1-xx
SR80-18H6-EN1	18	155	50	100	25	20	P2-EN1-xx
SR80-19H6-EN1	19	155	50	100	25	20	P2-EN1-xx
SR80-20H6-EN1	20	155	50	100	30	20	P4-EN1-xx
SR80-21H6-EN1	21	191	56	128	30	25	P4-EN1-xx
SR80-22H6-EN1	22	191	56	129	30	25	P4-EN1-xx
SR80-23H6-EN1	23	191	56	129	30	25	P4-EN1-xx
SR80-24H6-EN1	24	191	56	129	30	25	P4-EN1-xx
SR80-25H6-EN1	25	191	56	129	30	25	P4-EN1-xx
SR80-26H6-EN1	26	191	56	129	30	25	P4-EN1-xx

Parti di ricambio, comprese nella fornitura

Per \varnothing (mm)	Vite di regolazione	Staffa	Vite di bloccaggio	Chiave di regolazione	Sfera di supporto	Chiave dinamometrica	Valore di coppia
7-8	SH2020	SR-B0	LH2040	0.9SMS795	BB1.5	-	-
9	SH2025	SR-B1	LH2540	1.3SMS795	BB2.0	H00-1305	0,5 Nm
10-12	SH2525	SR-B2	LH2540	1.3SMS795	BB2.0	H00-1305	0,5 Nm
13-19	SH2540	SR-B3	LH3050	1.5SMS795	BB2.5	H00-1509	0,9 Nm
20-60	SH3060	SR-B5	LH4010	2SMS795	BB3.0	H00-2020	2,0 Nm

Per fori passanti \varnothing 27H6–60H6

Tipo di codolo R1, cilindrico senza piano, SR80

Introduzione

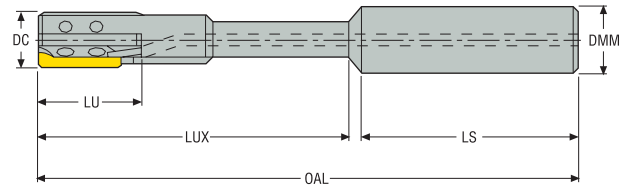

- Informazioni sulle lame alle pagine 436, 437
- Adduzione refrigerante interna
- Per i parametri di taglio raccomandati, vedere pagina(e) 438-446

Foratura

Descrizione	DC	OAL	LS	LUX	LU	DMM	Dimensione lama
	mm	mm	mm	mm	mm	mm	
SR80-27H6-EN1	27	221	56	159	30	25	P4-EN1-xx
SR80-28H6-EN1	28	221	56	159	30	25	P4-EN1-xx
SR80-29H6-EN1	29	221	56	159	30	25	P4-EN1-xx
SR80-30H6-EN1	30	221	56	159	30	25	P4-EN1-xx
SR80-31H6-EN1	31	221	56	160	30	25	P4-EN1-xx
SR80-32H6-EN1	32	221	56	160	30	25	P4-EN1-xx
SR80-34H6-EN1	34	226	56	165	30	25	P4-EN1-xx
SR80-35H6-EN1	35	226	56	165	30	25	P4-EN1-xx
SR80-36H6-EN1	36	226	56	166	30	25	P4-EN1-xx
SR80-38H6-EN1	38	226	56	166	30	25	P4-EN1-xx
SR80-40H6-EN1	40	226	56	166	30	25	P4-EN1-xx
SR80-42H6-EN1	42	226	56	167	30	25	P4-EN1-xx
SR80-44H6-EN1	44	226	56	167	30	25	P4-EN1-xx
SR80-48H6-EN1	48	226	56	168	30	25	P4-EN1-xx
SR80-50H6-EN1	50	226	56	168	30	25	P4-EN1-xx
SR80-52H6-EN1	52	226	56	169	30	25	P4-EN1-xx
SR80-54H6-EN1	54	226	56	169	30	25	P4-EN1-xx
SR80-58H6-EN1	58	226	56	169	30	25	P4-EN1-xx
SR80-60H6-EN1	60	226	56	169	30	25	P4-EN1-xx

Alesatura

Barenatura

Parti di ricambio, comprese nella fornitura

Per \varnothing (mm)	Vite di regolazione	Staffa	Vite di bloccaggio	Chiave di regolazione	Sfera di supporto	Chiave dinamometrica	Valore di coppia
20-60	SH4060	SR-B5	LH4010	2SMS795	BB3.0	H00-2020	2,0 Nm

La chiave dinamometrica viene fornita con la lama

Allegato

Per fori passanti – Diametro intermedio

Tipo di codolo R1, cilindrico senza piano, SR80

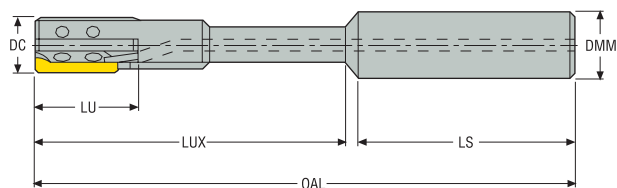

























- Informazioni sulle lame alle pagine 436, 437
- Importante! L'alesatore e la lama devono avere la stessa geometria di imbocco
- Per la scelta della geometria di imbocco EN1, EN2 oppure EN3 vedere le pagine 427
- Per i parametri di taglio raccomandati, vedere pagina(e) 438-446

Codice di ordinazione	DC	OAL	LS	LUX	LU	DMM	Dimensione lama
	mm	mm	mm	mm	mm	mm	
SR80-6.875-XX-XXXX-EN	6,875 - 7,874	105,0	40,0	63,0	15,0	10,0	P0-EN-xx
SR80-7.875-XX-XXXX-EN	7,875 - 8,749	115,0	40,0	73,0	25,0	10,0	P0-EN-xx
SR80-8.750-XX-XXXX-EN	8,75 - 9,749	115,0	40,0	73,0	25,0	10,0	P1-EN-xx
SR80-9.750-XX-XXXX-EN	9,75 - 10,749	115,0	40,0	73,0	25,0	10,0	P1-EN-xx
SR80-10.750-XX-XXXX-EN	10,75 - 12,749	133,0	48,0	81,0	25,0	16,0	P1-EN-xx
SR80-12.750-XX-XXXX-EN	12,75 - 16,749	133,0	48,0	81,0	25,0	16,0	P2-EN-xx
SR80-16.750-XX-XXXX-EN	16,75 - 19,499	155,0	50,0	100,0	25,0	20,0	P2-EN-xx
SR80-19.500-XX-XXXX-EN	19,5 - 20,499	155,0	50,0	100,0	30,0	20,0	P4-EN-xx
SR80-20.500-XX-XXXX-EN	20,5 - 26,499	191,0	56,0	129,0	30,0	25,0	P4-EN-xx
SR80-26.500-XX-XXXX-EN	26,5 - 32,499	221,0	56,0	160,0	30,0	25,0	P4-EN-xx
SR80-32.500-XX-XXXX-EN	32,5 - 38,499	226,0	56,0	165,0	30,0	25,0	P4-EN-xx
SR80-38.500-XX-XXXX-EN	38,5 - 40,499	226,0	56,0	166,0	30,0	25,0	P4-EN-xx
SR80-40.500-XX-XXXX-EN	40,5 - 44,499	226,0	56,0	167,0	30,0	25,0	P4-EN-xx
SR80-44.500-XX-XXXX-EN	44,5 - 50,499	226,0	56,0	168,0	30,0	25,0	P4-EN-xx
SR80-50.500-XX-XXXX-EN	50,5 - 60,5	226,0	56,0	169,0	30,0	25,0	P4-EN-xx

Parti di ricambio, comprese nella fornitura

Accessori

Per Ø (mm)	Vite di regolazione	Staffa	Vite staffa	Chiave di regolazione	Sfera d'appoggio	Chiave dinamometrica
6,875-8,749	 SH2020	 SR-B0	 LH2040	 0.9SMS795	 BB1.5	-
8,750-9,749	 SH2525	 SR-B1	 LH2540	 1.3SMS795	 BB2.0	H00-1305
9,750-12,749	 SH2525	 SR-B2	 LH2540	 1.3SMS795	 BB2.0	H00-1305
12,750-19,499	 SH3040	 SR-B3	 LH3050	 1.5SMS795	 BB2.0	H00-1509
19,500-60,500	 SH4060	 SR-B5	 LH4010	 2SMS795	 BB3.0	H00-2020

La chiave dinamometrica viene fornita con la lama

Nota! Quando si ordinano alesatori per diametro intermedio, indicare quanto segue: Ø e tolleranza del foro da alesare, geometria di imbocco (EN1, EN2 o EN3).

Esempio d'ordine: SR80-11.50 H7-EN2, P1-EN2-06, CP20.

Per fori ciechi \varnothing 8H6-26H6

Tipo di codolo R1, cilindrico senza piano, SR81

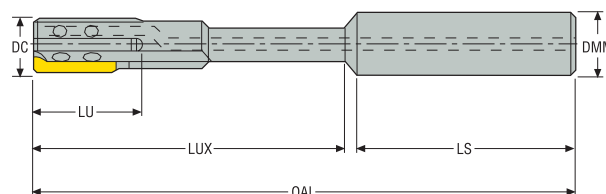

- Informazioni sulle lame alle pagine 436, 437
- Adduzione refrigerante interna
- Per i parametri di taglio raccomandati, vedere pagina(e) 438-446

Descrizione	DC	OAL	LS	LUX	LU	DMM	Dimensione lama
	mm	mm	mm	mm	mm	mm	
SR81-8H6-EN1	8	115	40	73	25	10	P0-EN1-xx
SR81-9H6-EN1	9	115	40	73	25	10	P1-EN1-xx
SR81-11H6-EN1	11	133	48	81	25	16	P1-EN1-xx
SR81-13H6-EN1	13	133	48	81	25	16	P2-EN1-xx
SR81-14H6-EN1	14	133	48	81	25	16	P2-EN1-xx
SR81-15H6-EN1	15	133	48	82	25	16	P2-EN1-xx
SR81-16H6-EN1	16	133	48	82	25	16	P2-EN1-xx
SR81-17H6-EN1	17	155	50	100	25	20	P2-EN1-xx
SR81-18H6-EN1	18	155	50	100	25	20	P2-EN1-xx
SR81-19H6-EN1	19	155	50	100	25	20	P2-EN1-xx
SR81-20H6-EN1	20	155	50	100	30	20	P4-EN1-xx
SR81-21H6-EN1	21	191	56	128	30	25	P4-EN1-xx
SR81-22H6-EN1	22	191	56	129	30	25	P4-EN1-xx
SR81-23H6-EN1	23	191	56	129	30	25	P4-EN1-xx
SR81-25H6-EN1	25	191	56	129	30	25	P4-EN1-xx
SR81-26H6-EN1	26	191	56	129	30	25	P4-EN1-xx

Parti di ricambio, comprese nella fornitura

Per \varnothing (mm)	Vite di regolazione	Staffa	Vite di bloccaggio	Chiave di regolazione	Sfera di supporto	Chiave dinamometrica	Valore di coppia
8	SH2020	SR-B0	LH2040	0.9SMS795	BB1.5	-	-
9	SH2525	SR-B1	LH2540	1.3SMS795	BB2.0	H00-1305	0,5 Nm
10-12	SH2525	SR-B2	LH2540	1.3SMS795	BB2.0	H00-1305	0,5 Nm
13-19	SH3040	SR-B3	LH3050	1.5SMS795	BB2.5	H00-1509	0,9 Nm
20-60	SH4060	SR-B5	LH4010	2SMS795	BB3.0	H00-2020	2,0 Nm

La chiave dinamometrica viene fornita con la lama

Per fori ciechi Ø 27H6-60H6

Tipo di codolo R1, cilindrico senza piano, SR81

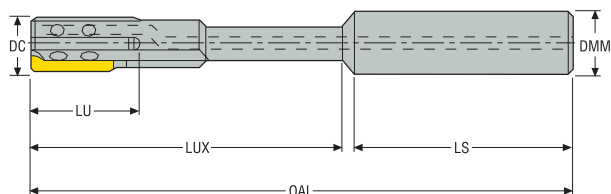

- Informazioni sulle lame alle pagine 436, 437
- Adduzione refrigerante interna
- Per i parametri di taglio raccomandati, vedere pagina(e) 438-446

Descrizione	DC	OAL	LS	LUX	LU	DMM	Dimensione lama
	mm	mm	mm	mm	mm	mm	
SR81-27H6-EN1	27	221	56	159	30	25	P4-EN1-xx
SR81-28H6-EN1	28	221	56	159	30	25	P4-EN1-xx
SR81-29H6-EN1	29	221	56	159	30	25	P4-EN1-xx
SR81-30H6-EN1	30	221	56	159	30	25	P4-EN1-xx
SR81-31H6-EN1	31	221	56	160	30	25	P4-EN1-xx
SR81-32H6-EN1	32	221	56	160	30	25	P4-EN1-xx
SR81-34H6-EN1	34	226	56	165	30	25	P4-EN1-xx
SR81-35H6-EN1	35	226	56	165	30	25	P4-EN1-xx
SR81-36H6-EN1	36	226	56	166	30	25	P4-EN1-xx
SR81-38H6-EN1	38	226	56	166	30	25	P4-EN1-xx
SR81-40H6-EN1	40	226	56	166	30	25	P4-EN1-xx
SR81-42H6-EN1	42	226	56	167	30	25	P4-EN1-xx
SR81-44H6-EN1	44	226	56	167	30	25	P4-EN1-xx
SR81-48H6-EN1	48	226	56	168	30	25	P4-EN1-xx
SR81-50H6-EN1	50	226	56	168	30	25	P4-EN1-xx
SR81-52H6-EN1	52	226	56	169	30	25	P4-EN1-xx
SR81-54H6-EN1	54	226	56	169	30	25	P4-EN1-xx
SR81-58H6-EN1	58	226	56	169	30	25	P4-EN1-xx
SR81-60H6-EN1	60	226	56	169	30	25	P4-EN1-xx

Parti di ricambio, comprese nella fornitura

Per Ø (mm)	Vite di regolazione	Staffa	Vite di bloccaggio	Chiave di regolazione	Sfera di supporto	Chiave dinamometrica	Valore di coppia
20-60	SH4060	SR-B5	LH4010	2SMS795	BB3.0	H00-2020	2,0 Nm

Per fori ciechi – Diametro intermedio

Tipo di codolo R1, cilindrico senza piano, SR81

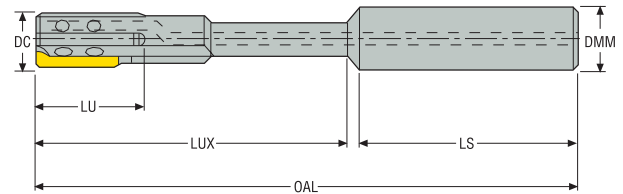

- Informazioni sulle lame alle pagine 436, 437
- Importante! L'alesatore e la lama devono avere la stessa geometria di imbocco
- Per la scelta della geometria di imbocco EN1, EN2 oppure EN3 vedere le pagine 427
- Per i parametri di taglio raccomandati, vedere pagina(e) 438-446

Codice di ordinazione	DC	OAL	LS	LUX	LU	DMM	Dimensione lama
	mm	mm	mm	mm	mm	mm	
SR81-7.875-XX-XXXX-EN	7,875 - 8,749	115,0	40,0	73,0	25,0	10,0	P0-EN-xx
SR81-8.750-XX-XXXX-EN	8,75 - 9,749	115,0	40,0	73,0	25,0	10,0	P1-EN-xx
SR81-9.750-XX-XXXX-EN	9,75 - 10,749	115,0	40,0	73,0	25,0	10,0	P1-EN-xx
SR81-10.750-XX-XXXX-EN	10,75 - 12,749	133,0	48,0	81,0	25,0	16,0	P1-EN-xx
SR81-12.750-XX-XXXX-EN	12,75 - 16,749	133,0	48,0	81,0	25,0	16,0	P2-EN-xx
SR81-16.750-XX-XXXX-EN	16,75 - 19,499	155,0	50,0	100,0	25,0	20,0	P2-EN-xx
SR81-19.500-XX-XXXX-EN	19,5 - 20,499	155,0	50,0	100,0	30,0	20,0	P4-EN-xx
SR81-20.500-XX-XXXX-EN	20,5 - 26,499	191,0	56,0	129,0	30,0	25,0	P4-EN-xx
SR81-26.500-XX-XXXX-EN	26,5 - 32,499	221,0	56,0	160,0	30,0	25,0	P4-EN-xx
SR81-32.500-XX-XXXX-EN	32,5 - 38,499	226,0	56,0	165,0	30,0	25,0	P4-EN-xx
SR81-38.500-XX-XXXX-EN	38,5 - 40,499	226,0	56,0	166,0	30,0	25,0	P4-EN-xx
SR81-40.500-XX-XXXX-EN	40,5 - 44,499	226,0	56,0	167,0	30,0	25,0	P4-EN-xx
SR81-44.500-XX-XXXX-EN	44,5 - 50,499	226,0	56,0	168,0	30,0	25,0	P4-EN-xx
SR81-50.500-XX-XXXX-EN	50,5 - 60,5	226,0	56,0	169,0	30,0	25,0	P4-EN-xx

Parti di ricambio, comprese nella fornitura

Accessori

Per Ø (mm)	Vite di regolazione	Staffa	Vite staffa	Chiave di regolazione	Sfera d'appoggio	Chiave dinamometrica
9,75-12,749	SH2525	SR-B2	LH2540	1.3SMS795	BB2.0	H00-1305
12,75-19,499	SH3040	SR-B3	LH3050	1.5SMS795	BB2.5	H00-1509
19,5-60,5	SH4060	SR-B5	LH4010	2SMS795	BB3.0	H00-2020
7,875-8,749	SH2020	SR-B0	LH2040	0.9SMS795	BB1.5	-
8,75-9,749	SH2525	SR-B1	LH2540	1.3SMS795	BB2.0	H00-1305

La chiave dinamometrica viene fornita con la lama

Nota! Quando si ordinano alesatori per diametro intermedio, indicare quanto segue: Ø e tolleranza del foro da alesare, geometria di imbocco (EN1, EN2 o EN3).

Esempio d'ordine: SR81-11.50 H7-EN2, P1-EN2-06, CP20.

Per fori ciechi – Versione corta per applicazioni di tornitura

Tipo di codolo R9, cilindrico con piano, SR82

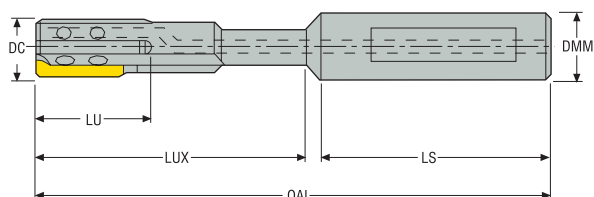

- Informazioni sulle lame alle pagine 436, 437
- Importante! L'alesatore e la lama devono avere la stessa geometria di imbocco
- Per la scelta della geometria di imbocco EN1, EN2 oppure EN3 vedere le pagine 427
- Per i parametri di taglio raccomandati, vedere pagina(e) 438-446

Codice di ordinazione	DC	OAL	LS	LUX	LU	DMM	Dimensione lama
	mm	mm	mm	mm	mm	mm	
SR82-7.875-XX-XXXX-EN	7,875 - 8,749	95,0	40,0	53,0	25,0	10,0	P0-EN-xx
SR82-8.750-XX-XXXX-EN	8,75 - 9,749	95,0	40,0	53,0	25,0	10,0	P1-EN-xx
SR82-9.750-XX-XXXX-EN	9,75 - 10,749	95,0	40,0	53,0	25,0	10,0	P1-EN-xx
SR82-10.750-XX-XXXX-EN	10,75 - 12,749	113,0	40,0	61,0	25,0	16,0	P1-EN-xx
SR82-12.750-XX-XXXX-EN	12,75 - 16,749	113,0	48,0	61,0	25,0	16,0	P2-EN-xx
SR82-16.750-XX-XXXX-EN	16,75 - 19,499	113,0	48,0	60,0	25,0	20,0	P2-EN-xx
SR82-19.500-XX-XXXX-EN	19,5 - 20,499	115,0	50,0	60,0	30,0	20,0	P4-EN-xx
SR82-20.500-XX-XXXX-EN	20,5 - 32,499	115,0	50,0	89,0	30,0	25,0	P4-EN-xx
SR82-32.500-XX-XXXX-EN	32,5 - 36,499	151,0	56,0	105,0	30,0	25,0	P4-EN-xx
SR82-36.500-XX-XXXX-EN	36,5 - 40,499	166,0	56,0	106,0	30,0	25,0	P4-EN-xx
SR82-40.500-XX-XXXX-EN	40,5 - 44,499	166,0	56,0	107,0	30,0	25,0	P4-EN-xx
SR82-44.500-XX-XXXX-EN	44,5 - 50,499	166,0	56,0	108,0	30,0	25,0	P4-EN-xx
SR82-50.500-XX-XXXX-EN	50,5 - 60,5	166,0	56,0	109,0	30,0	25,0	P4-EN-xx

Parti di ricambio, comprese nella fornitura

Accessori

Per Ø (mm)	Vite di regolazione	Staffa	Vite staffa	Chiave di regolazione	Sfera d'appoggio	Chiave dinamometrica
9,75-12,749	SH2525	SR-B2	LH2540	1.3SMS795	BB2.0	H00-1305
12,75-19,499	SH3040	SR-B3	LH3050	1.5SMS795	BB2.5	H00-1509
19,5-60,5	SH4060	SR-B5	LH4010	2SMS795	BB3.0	H00-2020
7,875-8,749	SH2020	SR-B0	LH2040	0.9SMS795	BB1.5	-
8,75-9,749	SH2525	SR-B1	LH2540	1.3SMS795	BB2.0	H00-1305

La chiave dinamometrica viene fornita con la lama

Nota! Quando si ordinano alesatori per diametro intermedio, indicare quanto segue: Ø e tolleranza del foro da alesare, geometria di imbocco (EN1, EN2 o EN3).

Esempio d'ordine: SR82-11.50 H7EN2, P1-EN2-06, CP20.

P0-P4 Lame

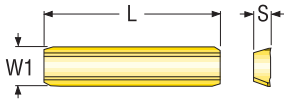

Codice di ordinazione	Inserto	L		S		W1		Qualità	
		mm	Inch	mm	Inch	mm	Inch	H15	CP20
P0-EN1-0	P0	20	0.787	1,2	0.047	2,5	0.098	00098229	00098244
P0-EN1-06	P0	20	0.787	1,2	0.047	2,5	0.098	00091786	00091762
P0-EN1-12	P0	20	0.787	1,2	0.047	2,5	0.098	00097299	00091971
P0-EN2-0	P0	20	0.787	1,2	0.047	2,5	0.098	00098234	00098249
P0-EN2-06	P0	20	0.787	1,2	0.047	2,5	0.098	00098160	00098170
P0-EN2-12	P0	20	0.787	1,2	0.047	2,5	0.098	00098165	00098175
P0-EN3-0	P0	20	0.787	1,2	0.047	2,5	0.098	00098239	00098254
P0-EN3-06	P0	20	0.787	1,2	0.047	2,5	0.098	00098185	00098195
P0-EN3-12	P0	20	0.787	1,2	0.047	2,5	0.098	00098190	00098200
P1-EN1-0	P1	20	0.787	1,5	0.059	3,0	0.118	00098230	00098245
P1-EN1-06	P1	20	0.787	1,5	0.059	3,0	0.118	00091787	00091764
P1-EN1-12	P1	20	0.787	1,5	0.059	3,0	0.118	00097300	00091972
P1-EN2-0	P1	20	0.787	1,5	0.059	3,0	0.118	00098235	00098250
P1-EN2-06	P1	20	0.787	1,5	0.059	3,0	0.118	00098161	00098171
P1-EN2-12	P1	20	0.787	1,5	0.059	3,0	0.118	00098166	00098176
P1-EN3-0	P1	20	0.787	1,5	0.059	3,0	0.118	00098240	00098255
P1-EN3-06	P1	20	0.787	1,5	0.059	3,0	0.118	00098186	00094702
P1-EN3-12	P1	20	0.787	1,5	0.059	3,0	0.118	00098191	00098201
P2-EN1-0	P2	20	0.787	2,0	0.079	4,5	0.177	00098231	00098246
P2-EN1-06	P2	20	0.787	2,0	0.079	4,5	0.177	00091788	00091765
P2-EN1-12	P2	20	0.787	2,0	0.079	4,5	0.177	00097301	00091973
P2-EN2-0	P2	20	0.787	2,0	0.079	4,5	0.177	00098236	00098251
P2-EN2-06	P2	20	0.787	2,0	0.079	4,5	0.177	00098162	00098172
P2-EN2-12	P2	20	0.787	2,0	0.079	4,5	0.177	00098167	00098177
P2-EN3-0	P2	20	0.787	2,0	0.079	4,5	0.177	00098241	00098256

Codice di ordinazione	Inserito	L		S		W1		Qualità	
		mm <i>Inch</i>		mm <i>Inch</i>		mm <i>Inch</i>		H15	CP20
P2-EN3-06	P2	20 <i>0.787</i>		2,0 <i>0.079</i>		4,5 <i>0.177</i>		00098187	00098197
P2-EN3-12	P2	20 <i>0.787</i>		2,0 <i>0.079</i>		4,5 <i>0.177</i>		00098192	00098202
P4-EN1-0	P4	25,0 <i>0.984</i>		2,3 <i>0.091</i>		7,0 <i>0.276</i>		00098232	00098247
P4-EN1-06	P4	25,0 <i>0.984</i>		2,3 <i>0.091</i>		7,0 <i>0.276</i>		00091789	00091766
P4-EN1-12	P4	25,0 <i>0.984</i>		2,3 <i>0.091</i>		7,0 <i>0.276</i>		00098128	00091974
P4-EN2-0	P4	25,0 <i>0.984</i>		2,3 <i>0.091</i>		7,0 <i>0.276</i>		00098237	00098252
P4-EN2-06	P4	25,0 <i>0.984</i>		2,3 <i>0.091</i>		7,0 <i>0.276</i>		00098163	00098173
P4-EN2-12	P4	25,0 <i>0.984</i>		2,3 <i>0.091</i>		7,0 <i>0.276</i>		00098168	00098178
P4-EN3-0	P4	25,0 <i>0.984</i>		2,3 <i>0.091</i>		7,0 <i>0.276</i>		00098242	00098257
P4-EN3-06	P4	25,0 <i>0.984</i>		2,3 <i>0.091</i>		7,0 <i>0.276</i>		00098188	00098198
P4-EN3-12	P4	25,0 <i>0.984</i>		2,3 <i>0.091</i>		7,0 <i>0.276</i>		00098193	00098203

Introduzione

Foratura

Alesatura

Barenatura

Allegato

Parametri di taglio – Pxx-EN1/EN2-00 misure metriche

SMG		a_p (°)		f	v_c	
		$\varnothing < 9$	$\varnothing \geq 9$		CP20	CP15
P5	Pxx-EN1/EN2-00	0,10-0,15	0,10-0,20	0,10-0,30	40 (30-50)	-
P6	Pxx-EN1/EN2-00	0,10-0,15	0,10-0,20	0,10-0,30	40 (30-50)	-
P7	Pxx-EN1/EN2-00	0,10-0,15	0,10-0,20	0,10-0,30	40 (30-50)	-
K1	Pxx-EN1/EN2-00	0,10-0,20	0,10-0,30	0,10-0,30	90 (80-100)	120 (80-150)
K2	Pxx-EN1/EN2-00	0,10-0,20	0,10-0,30	0,10-0,30	35 (25-50)	50 (25-70)
K3	Pxx-EN1/EN2-00	0,10-0,20	0,10-0,30	0,10-0,30	90 (80-100)	120 (80-150)
K4	Pxx-EN1/EN2-00	0,10-0,20	0,10-0,30	0,10-0,30	70 (60-80)	90 (80-100)
K5	Pxx-EN1/EN2-00	0,10-0,20	0,10-0,30	0,10-0,30	70 (60-80)	90 (80-100)
K6	Pxx-EN1/EN2-00	0,10-0,20	0,10-0,30	0,10-0,30	90 (80-100)	120 (80-150)
K7	Pxx-EN1/EN2-00	0,10-0,20	0,10-0,30	0,10-0,30	90 (80-100)	120 (80-150)
PM1	Pxx-EN1/EN2-00	0,10-0,20	0,10-0,30	0,10-0,30	50 (25-70)	-
PM2	Pxx-EN1/EN2-00	0,10-0,20	0,10-0,30	0,10-0,30	50 (25-70)	-
PM3	Pxx-EN1/EN2-00	0,10-0,20	0,10-0,30	0,10-0,30	50 (25-70)	-

SMG = Gruppo materiale Seco

a_p = mm

f = mm/rev

v_c = m/min

Tutti i parametri di taglio sono valori di partenza

Parametri di taglio – Pxx-EN1/EN2-00 pollici

SMG		a_p (°)		f	v_c	
		$\varnothing < 9$	$\varnothing \geq 9$		CP20	CP15
P5	Pxx-EN1/EN2-00	0.004–0.006	0.004–0.008	0.004–0.012	130 (100-165)	-
P6	Pxx-EN1/EN2-00	0.004–0.006	0.004–0.008	0.004–0.012	130 (100-165)	-
P7	Pxx-EN1/EN2-00	0.004–0.006	0.004–0.008	0.004–0.012	130 (100-165)	-
K1	Pxx-EN1/EN2-00	0.004–0.008	0.004–0.012	0.004–0.012	295 (260-330)	395 (260-490)
K2	Pxx-EN1/EN2-00	0.004–0.008	0.004–0.012	0.004–0.012	115 (80-165)	165 (80-230)
K3	Pxx-EN1/EN2-00	0.004–0.008	0.004–0.012	0.004–0.012	295 (260-330)	395 (260-490)
K4	Pxx-EN1/EN2-00	0.004–0.008	0.004–0.012	0.004–0.012	230 (195-260)	295 (260-330)
K5	Pxx-EN1/EN2-00	0.004–0.008	0.004–0.012	0.004–0.012	230 (195-260)	295 (260-330)
K6	Pxx-EN1/EN2-00	0.004–0.008	0.004–0.012	0.004–0.012	295 (260-330)	395 (260-490)
K7	Pxx-EN1/EN2-00	0.004–0.008	0.004–0.012	0.004–0.012	295 (260-330)	395 (260-490)
PM1	Pxx-EN1/EN2-00	0.004–0.008	0.004–0.012	0.004–0.012	165 (80-230)	-
PM2	Pxx-EN1/EN2-00	0.004–0.008	0.004–0.012	0.004–0.012	165 (80-230)	-
PM3	Pxx-EN1/EN2-00	0.004–0.008	0.004–0.012	0.004–0.012	165 (80-230)	-

SMG = Gruppo materiale Seco

a_p = inch

f = in/rev

v_c = sf/min

Tutti i parametri di taglio sono valori di partenza

Parametri di taglio – Pxx-EN1/EN2-06 misure metriche

SMG		a_p (°)		f	v_c		
		$\varnothing < 9$	$\varnothing \geq 9$		H15	CP20	CP15
P1	Pxx-EN1/EN2-06	0,10-0,15	0,10-0,20	0,10-0,30	40 (30-60)	105 (90-120)	120 (90-150)
P2	Pxx-EN1/EN2-06	0,10-0,15	0,10-0,20	0,10-0,30	40 (30-60)	105 (90-120)	120 (90-150)
P3	Pxx-EN1/EN2-06	0,10-0,15	0,10-0,20	0,10-0,30	40 (30-60)	105 (90-120)	120 (90-150)
P4	Pxx-EN1/EN2-06	0,10-0,15	0,10-0,20	0,10-0,30	35 (25-40)	60 (40-70)	80 (60-100)
P5	Pxx-EN1/EN2-06	0,10-0,15	0,10-0,20	0,10-0,30	35 (25-40)	60 (40-70)	80 (60-100)
P6	Pxx-EN1/EN2-06	0,10-0,15	0,10-0,20	0,10-0,30	35 (25-40)	60 (40-70)	80 (60-100)
P7	Pxx-EN1/EN2-06	0,10-0,15	0,10-0,20	0,10-0,30	35 (25-40)	60 (40-70)	80 (60-100)
P8	Pxx-EN1/EN2-06	0,10-0,15	0,10-0,20	0,10-0,30	30 (25-40)	50 (30-60)	60 (40-70)
P11	Pxx-EN1/EN2-06	0,10-0,15	0,10-0,20	0,10-0,30	30 (25-40)	50 (30-60)	60 (40-70)
P12	Pxx-EN1/EN2-06	0,10-0,15	0,10-0,20	0,10-0,30	25 (20-30)	40 (25-45)	45 (30-55)
M1	Pxx-EN1/EN2-06	0,10-0,15	0,10-0,20	0,10-0,30	25 (20-30)	35 (25-40)	35 (25-40)
M2	Pxx-EN1/EN2-06	0,10-0,15	0,10-0,20	0,10-0,30	25 (20-30)	35 (25-40)	35 (25-40)
M3	Pxx-EN1/EN2-06	0,10-0,15	0,10-0,20	0,10-0,30	25 (20-30)	35 (25-40)	35 (25-40)
M4	Pxx-EN1/EN2-06	0,10-0,15	0,10-0,20	0,10-0,30	20 (15-30)	30 (25-40)	30 (25-40)
M5	Pxx-EN1/EN2-06	0,10-0,15	0,10-0,20	0,10-0,30	20 (15-30)	30 (25-40)	30 (25-40)
K1	Pxx-EN1/EN2-06	0,10-0,20	0,10-0,30	0,10-0,30	-	90 (80-100)	120 (80-150)
K2	Pxx-EN1/EN2-06	0,10-0,20	0,10-0,30	0,10-0,30	-	35 (25-50)	50 (25-70)
K3	Pxx-EN1/EN2-06	0,10-0,20	0,10-0,30	0,10-0,30	-	90 (80-100)	120 (80-150)
K4	Pxx-EN1/EN2-06	0,10-0,20	0,10-0,30	0,10-0,30	-	70 (60-80)	90 (80-100)
K5	Pxx-EN1/EN2-06	0,10-0,20	0,10-0,30	0,10-0,30	-	70 (60-80)	90 (80-100)
K6	Pxx-EN1/EN2-06	0,10-0,20	0,10-0,30	0,10-0,30	-	90 (80-100)	120 (80-150)
K7	Pxx-EN1/EN2-06	0,10-0,20	0,10-0,30	0,10-0,30	-	90 (80-100)	120 (80-150)
N11	Pxx-EN1/EN2-06	0,10-0,30	0,20-0,50	0,10-0,30	65 (50-150)	90 (70-150)	-
S1	Pxx-EN1/EN2-06	0,10-0,15	0,10-0,20	0,10-0,30	-	25 (15-30)	-
S2	Pxx-EN1/EN2-06	0,10-0,15	0,10-0,20	0,10-0,30	-	25 (15-30)	-
S3	Pxx-EN1/EN2-06	0,10-0,15	0,10-0,20	0,10-0,30	-	25 (15-30)	-
PM1	Pxx-EN1/EN2-06	0,10-0,20	0,10-0,30	0,10-0,30	-	50 (25-70)	-
PM2	Pxx-EN1/EN2-06	0,10-0,20	0,10-0,30	0,10-0,30	-	50 (25-70)	-
PM3	Pxx-EN1/EN2-06	0,10-0,20	0,10-0,30	0,10-0,30	-	50 (25-70)	-

SMG = Gruppo materiale Seco

a_p = mm

f = mm/rev

v_c = m/min

Tutti i parametri di taglio sono valori di partenza

Introduzione

Foratura

Alesatura

Barenatura

Allegato

Parametri di taglio – Pxx-EN1/EN2-06 pollici

SMG		a_p (°)		f	v_c			
		$\emptyset < 9$	$\emptyset \geq 9$		H15	CP20	CP15	
Introduzione	P1	Pxx-EN1/EN2-06	0.004–0.006	0.004–0.008	0.004–0.012	130 (100-195)	345 (295-395)	395 (295-490)
	P2	Pxx-EN1/EN2-06	0.004–0.006	0.004–0.008	0.004–0.012	130 (100-195)	345 (295-395)	395 (295-490)
	P3	Pxx-EN1/EN2-06	0.004–0.006	0.004–0.008	0.004–0.012	130 (100-195)	345 (295-395)	395 (295-490)
	P4	Pxx-EN1/EN2-06	0.004–0.006	0.004–0.008	0.004–0.012	115 (80-130)	195 (130-230)	260 (195-330)
	P5	Pxx-EN1/EN2-06	0.004–0.006	0.004–0.008	0.004–0.012	115 (80-130)	195 (130-230)	260 (195-330)
	P6	Pxx-EN1/EN2-06	0.004–0.006	0.004–0.008	0.004–0.012	115 (80-130)	195 (130-230)	260 (195-330)
	P7	Pxx-EN1/EN2-06	0.004–0.006	0.004–0.008	0.004–0.012	115 (80-130)	195 (130-230)	260 (195-330)
	P8	Pxx-EN1/EN2-06	0.004–0.006	0.004–0.008	0.004–0.012	100 (80-130)	165 (100-195)	195 (130-230)
Foratura	P11	Pxx-EN1/EN2-06	0.004–0.006	0.004–0.008	0.004–0.012	100 (80-130)	165 (100-195)	195 (130-230)
	P12	Pxx-EN1/EN2-06	0.004–0.006	0.004–0.008	0.004–0.012	80 (65-100)	130 (80-150)	150 (100-180)
	M1	Pxx-EN1/EN2-06	0.004–0.006	0.004–0.008	0.004–0.012	80 (65-100)	115 (80-130)	115 (80-130)
	M2	Pxx-EN1/EN2-06	0.004–0.006	0.004–0.008	0.004–0.012	80 (65-100)	115 (80-130)	115 (80-130)
	M3	Pxx-EN1/EN2-06	0.004–0.006	0.004–0.008	0.004–0.012	80 (65-100)	115 (80-130)	115 (80-130)
	M4	Pxx-EN1/EN2-06	0.004–0.006	0.004–0.008	0.004–0.012	65 (50-100)	100 (80-130)	100 (80-130)
	M5	Pxx-EN1/EN2-06	0.004–0.006	0.004–0.008	0.004–0.012	65 (50-100)	100 (80-130)	100 (80-130)
	K1	Pxx-EN1/EN2-06	0.004–0.008	0.004–0.012	0.004–0.012	–	295 (260-330)	395 (260-490)
	K2	Pxx-EN1/EN2-06	0.004–0.008	0.004–0.012	0.004–0.012	–	115 (80-165)	165 (80-230)
	K3	Pxx-EN1/EN2-06	0.004–0.008	0.004–0.012	0.004–0.012	–	295 (260-330)	395 (260-490)
	K4	Pxx-EN1/EN2-06	0.004–0.008	0.004–0.012	0.004–0.012	–	230 (195-260)	295 (260-330)
	K5	Pxx-EN1/EN2-06	0.004–0.008	0.004–0.012	0.004–0.012	–	230 (195-260)	295 (260-330)
Alesatura	K6	Pxx-EN1/EN2-06	0.004–0.012	0.008–0.020	0.004–0.012	215 (165-150)	295 (230-490)	–
	K7	Pxx-EN1/EN2-06	0.004–0.012	0.008–0.020	0.004–0.012	215 (165-150)	295 (230-490)	–
	N11	Pxx-EN1/EN2-06	0.004–0.012	0.008–0.020	0.004–0.012	215 (165-150)	295 (230-490)	–
	S1	Pxx-EN1/EN2-06	0.004–0.006	0.004–0.008	0.004–0.012	–	80 (50-100)	–
	S2	Pxx-EN1/EN2-06	0.004–0.006	0.004–0.008	0.004–0.012	–	80 (50-100)	–
	S3	Pxx-EN1/EN2-06	0.004–0.006	0.004–0.008	0.004–0.012	–	80 (50-100)	–
	PM1	Pxx-EN1/EN2-06	0.004–0.008	0.004–0.012	0.004–0.012	–	165 (80-230)	–
PM2	Pxx-EN1/EN2-06	0.004–0.008	0.004–0.012	0.004–0.012	–	165 (80-230)	–	
PM3	Pxx-EN1/EN2-06	0.004–0.008	0.004–0.012	0.004–0.012	–	165 (80-230)	–	

SMG = Gruppo materiale Seco

a_p = inch

f = in/rev

v_c = sf/min

Tutti i parametri di taglio sono valori di partenza

Parametri di taglio – Pxx-EN1/EN2-12 misure metriche

SMG		a_p (°)		f	v_c		
		$\varnothing < 9$	$\varnothing \geq 9$		H15	CP20	CP15
P1	Pxx-EN1/EN2-12	0,10-0,15	0,10-0,20	0,10-0,30	40 (30-60)	105 (90-120)	120 (90-150)
P2	Pxx-EN1/EN2-12	0,10-0,15	0,10-0,20	0,10-0,30	40 (30-60)	105 (90-120)	120 (90-150)
P3	Pxx-EN1/EN2-12	0,10-0,15	0,10-0,20	0,10-0,30	40 (30-60)	105 (90-120)	120 (90-150)
P4	Pxx-EN1/EN2-12	0,10-0,15	0,10-0,20	0,10-0,30	35 (25-40)	60 (40-70)	80 (60-100)
P5	Pxx-EN1/EN2-12	0,10-0,15	0,10-0,20	0,10-0,30	35 (25-40)	60 (40-70)	80 (60-100)
P6	Pxx-EN1/EN2-12	0,10-0,15	0,10-0,20	0,10-0,30	35 (25-40)	60 (40-70)	80 (60-100)
P7	Pxx-EN1/EN2-12	0,10-0,15	0,10-0,20	0,10-0,30	35 (25-40)	60 (40-70)	80 (60-100)
P8	Pxx-EN1/EN2-12	0,10-0,15	0,10-0,20	0,10-0,30	30 (25-40)	50 (30-60)	60 (40-70)
P11	Pxx-EN1/EN2-12	0,10-0,15	0,10-0,20	0,10-0,30	30 (25-40)	50 (30-60)	60 (40-70)
P12	Pxx-EN1/EN2-12	0,10-0,15	0,10-0,20	0,10-0,30	25 (20-30)	40 (25-45)	45 (30-55)
M1	Pxx-EN1/EN2-12	0,10-0,15	0,10-0,20	0,10-0,30	25 (20-30)	35 (25-40)	35 (25-40)
M2	Pxx-EN1/EN2-12	0,10-0,15	0,10-0,20	0,10-0,30	25 (20-30)	35 (25-40)	35 (25-40)
M3	Pxx-EN1/EN2-12	0,10-0,15	0,10-0,20	0,10-0,30	25 (20-30)	35 (25-40)	35 (25-40)
M4	Pxx-EN1/EN2-12	0,10-0,15	0,10-0,20	0,10-0,30	20 (15-30)	30 (25-40)	30 (25-40)
M5	Pxx-EN1/EN2-12	0,10-0,15	0,10-0,20	0,10-0,30	20 (15-30)	30 (25-40)	30 (25-40)
K1	Pxx-EN1/EN2-12	0,10-0,20	0,10-0,30	0,10-0,30	-	90 (80-100)	-
K3	Pxx-EN1/EN2-12	0,10-0,20	0,10-0,30	0,10-0,30	-	90 (80-100)	-
K4	Pxx-EN1/EN2-12	0,10-0,20	0,10-0,30	0,10-0,30	-	70 (60-80)	-
K5	Pxx-EN1/EN2-12	0,10-0,20	0,10-0,30	0,10-0,30	-	70 (60-80)	-
N11	Pxx-EN1/EN2-12	0,10-0,30	0,20-0,50	0,10-0,30	65 (50-150)	90 (70-150)	-
S1	Pxx-EN1/EN2-12	0,10-0,15	0,10-0,20	0,10-0,30	-	25 (15-30)	-
S2	Pxx-EN1/EN2-12	0,10-0,15	0,10-0,20	0,10-0,30	-	25 (15-30)	-
S3	Pxx-EN1/EN2-12	0,10-0,15	0,10-0,20	0,10-0,30	-	25 (15-30)	-
PM1	Pxx-EN1/EN2-12	0,10-0,20	0,10-0,30	0,10-0,30	-	50 (25-70)	-
PM2	Pxx-EN1/EN2-12	0,10-0,20	0,10-0,30	0,10-0,30	-	50 (25-70)	-
PM3	Pxx-EN1/EN2-12	0,10-0,20	0,10-0,30	0,10-0,30	-	50 (25-70)	-

SMG = Gruppo materiale Seco

a_p = mm

f = mm/rev

v_c = m/min

Tutti i parametri di taglio sono valori di partenza

Introduzione

Foratura

Alesatura

Barenatura

Allegato

Parametri di taglio – Pxx-EN1/EN2-12 pollici

SMG		a_p (°)		f	v_c		
		$\emptyset < 9$	$\emptyset \geq 9$		H15	CP20	CP15
P1	Pxx-EN1/EN2-12	0.004-0.006	0.004-0.008	0.004-0.012	130 (100-195)	345 (295-395)	395 (295-490)
P2	Pxx-EN1/EN2-12	0.004-0.006	0.004-0.008	0.004-0.012	130 (100-195)	345 (295-395)	395 (295-490)
P3	Pxx-EN1/EN2-12	0.004-0.006	0.004-0.008	0.004-0.012	130 (100-195)	345 (295-395)	395 (295-490)
P4	Pxx-EN1/EN2-12	0.004-0.006	0.004-0.008	0.004-0.012	115 (80-130)	195 (130-230)	260 (195-330)
P5	Pxx-EN1/EN2-12	0.004-0.006	0.004-0.008	0.004-0.012	115 (80-130)	195 (130-230)	260 (195-330)
P6	Pxx-EN1/EN2-12	0.004-0.006	0.004-0.008	0.004-0.012	115 (80-130)	195 (130-230)	260 (195-330)
P7	Pxx-EN1/EN2-12	0.004-0.006	0.004-0.008	0.004-0.012	115 (80-130)	195 (130-230)	260 (195-330)
P8	Pxx-EN1/EN2-12	0.004-0.006	0.004-0.008	0.004-0.012	100 (80-130)	165 (100-195)	195 (130-230)
P11	Pxx-EN1/EN2-12	0.004-0.006	0.004-0.008	0.004-0.012	100 (80-130)	165 (100-195)	195 (130-230)
P12	Pxx-EN1/EN2-12	0.004-0.006	0.004-0.008	0.004-0.012	80 (65-100)	130 (80-150)	150 (100-180)
M1	Pxx-EN1/EN2-12	0.004-0.006	0.004-0.008	0.004-0.012	80 (65-100)	115 (80-130)	115 (80-130)
M2	Pxx-EN1/EN2-12	0.004-0.006	0.004-0.008	0.004-0.012	80 (65-100)	115 (80-130)	115 (80-130)
M3	Pxx-EN1/EN2-12	0.004-0.006	0.004-0.008	0.004-0.012	80 (65-100)	115 (80-130)	115 (80-130)
M4	Pxx-EN1/EN2-12	0.004-0.006	0.004-0.008	0.004-0.012	65 (50-100)	100 (80-130)	100 (80-130)
M5	Pxx-EN1/EN2-12	0.004-0.006	0.004-0.008	0.004-0.012	65 (50-100)	100 (80-130)	100 (80-130)
K1	Pxx-EN1/EN2-12	0.004-0.008	0.004-0.012	0.004-0.012	-	295 (260-330)	-
K3	Pxx-EN1/EN2-12	0.004-0.008	0.004-0.012	0.004-0.012	-	295 (260-330)	-
K4	Pxx-EN1/EN2-12	0.004-0.008	0.004-0.012	0.004-0.012	-	230 (195-260)	-
K5	Pxx-EN1/EN2-12	0.004-0.008	0.004-0.012	0.004-0.012	-	230 (195-260)	-
N11	Pxx-EN1/EN2-12	0.004-0.012	0.008-0.020	0.004-0.012	215 (165-490)	295 (230-490)	-
S1	Pxx-EN1/EN2-12	0.004-0.006	0.004-0.008	0.004-0.012	-	80 (50-100)	-
S2	Pxx-EN1/EN2-12	0.004-0.006	0.004-0.008	0.004-0.012	-	80 (50-100)	-
S3	Pxx-EN1/EN2-12	0.004-0.006	0.004-0.008	0.004-0.012	-	80 (50-100)	-
PM1	Pxx-EN1/EN2-12	0.004-0.008	0.004-0.012	0.004-0.012	-	165 (80-230)	-
PM2	Pxx-EN1/EN2-12	0.004-0.008	0.004-0.012	0.004-0.012	-	165 (80-230)	-
PM3	Pxx-EN1/EN2-12	0.004-0.008	0.004-0.012	0.004-0.012	-	165 (80-230)	-

SMG = Gruppo materiale Seco

a_p = inch

f = in/rev

v_c = sf/min

Tutti i parametri di taglio sono valori di partenza

Introduzione

Foratura

Alesatura

Barenatura

Allegato

Parametri di taglio – Pxx-EN3-00 misure metriche

SMG		a_p (∅)		f	v_c	
		$\emptyset < 9$	$\emptyset \geq 9$		CP20	CP15
P5	Pxx-EN3-00	0,10-0,15	0,10-0,20	0,10-0,30	40 (30-50)	-
P6	Pxx-EN3-00	0,10-0,15	0,10-0,20	0,10-0,30	40 (30-50)	-
P7	Pxx-EN3-00	0,10-0,15	0,10-0,20	0,10-0,30	40 (30-50)	-
K1	Pxx-EN3-00	0,10-0,20	0,10-0,30	0,10-0,30	90 (80-100)	120 (80-150)
K2	Pxx-EN3-00	0,10-0,20	0,10-0,30	0,10-0,30	35 (25-50)	50 (25-70)
K3	Pxx-EN3-00	0,10-0,20	0,10-0,30	0,10-0,30	90 (80-100)	120 (80-150)
K4	Pxx-EN3-00	0,10-0,20	0,10-0,30	0,10-0,30	70 (60-80)	90 (80-100)
K5	Pxx-EN3-00	0,10-0,20	0,10-0,30	0,10-0,30	70 (60-80)	90 (80-100)
K6	Pxx-EN3-00	0,10-0,20	0,10-0,30	0,10-0,30	90 (80-100)	120 (80-150)
K7	Pxx-EN3-00	0,10-0,20	0,10-0,30	0,10-0,30	90 (80-100)	120 (80-150)
PM1	Pxx-EN3-00	0,10-0,20	0,10-0,30	0,10-0,30	50 (25-70)	-
PM2	Pxx-EN3-00	0,10-0,20	0,10-0,30	0,10-0,30	50 (25-70)	-
PM3	Pxx-EN3-00	0,10-0,20	0,10-0,30	0,10-0,30	50 (25-70)	-

SMG = Gruppo materiale Seco

a_p = mm

f = mm/rev

v_c = m/min

Tutti i parametri di taglio sono valori di partenza

Parametri di taglio – Pxx-EN3-00 pollici

SMG		a_p (∅)		f	v_c	
		$\emptyset < 9$	$\emptyset \geq 9$		CP20	CP15
P5	Pxx-EN3-00	0.004-0.006	0.004-0.008	0.004-0.012	130 (100-165)	-
P6	Pxx-EN3-00	0.004-0.006	0.004-0.008	0.004-0.012	130 (100-165)	-
P7	Pxx-EN3-00	0.004-0.006	0.004-0.008	0.004-0.012	130 (100-165)	-
K1	Pxx-EN3-00	0.004-0.008	0.004-0.012	0.004-0.012	295 (260-330)	395 (260-490)
K2	Pxx-EN3-00	0.004-0.008	0.004-0.012	0.004-0.012	115 (80-165)	165 (80-230)
K3	Pxx-EN3-00	0.004-0.008	0.004-0.012	0.004-0.012	295 (260-330)	395 (260-490)
K4	Pxx-EN3-00	0.004-0.008	0.004-0.012	0.004-0.012	230 (195-260)	295 (260-330)
K5	Pxx-EN3-00	0.004-0.008	0.004-0.012	0.004-0.012	230 (195-260)	295 (260-330)
K6	Pxx-EN3-00	0.004-0.008	0.004-0.012	0.004-0.012	295 (260-330)	395 (260-490)
K7	Pxx-EN3-00	0.004-0.008	0.004-0.012	0.004-0.012	295 (260-330)	395 (260-490)
PM1	Pxx-EN3-00	0.004-0.008	0.004-0.012	0.004-0.012	165 (80-230)	-
PM2	Pxx-EN3-00	0.004-0.008	0.004-0.012	0.004-0.012	165 (80-230)	-
PM3	Pxx-EN3-00	0.004-0.008	0.004-0.012	0.004-0.012	165 (80-230)	-

SMG = Gruppo materiale Seco

a_p = inch

f = in/rev

v_c = sf/min

Tutti i parametri di taglio sono valori di partenza

Parametri di taglio – Pxx-EN3-06 misure metriche

SMG		$a_p (\varnothing)$		f	v_c		
		$\varnothing < 9$	$\varnothing \geq 9$		H15	CP20	CP15
P1	Pxx-EN3-06	0,10-0,15	0,10-0,20	0,10-0,30	40 (30-60)	105 (90-120)	120 (90-150)
P2	Pxx-EN3-06	0,10-0,15	0,10-0,20	0,10-0,30	40 (30-60)	105 (90-120)	120 (90-150)
P3	Pxx-EN3-06	0,10-0,15	0,10-0,20	0,10-0,30	40 (30-60)	105 (90-120)	120 (90-150)
P4	Pxx-EN3-06	0,10-0,15	0,10-0,20	0,10-0,30	35 (25-40)	60 (40-70)	80 (60-100)
P5	Pxx-EN3-06	0,10-0,15	0,10-0,20	0,10-0,30	35 (25-40)	60 (40-70)	80 (60-100)
P6	Pxx-EN3-06	0,10-0,15	0,10-0,20	0,10-0,30	35 (25-40)	60 (40-70)	80 (60-100)
P7	Pxx-EN3-06	0,10-0,15	0,10-0,20	0,10-0,30	35 (25-40)	60 (40-70)	80 (60-100)
P8	Pxx-EN3-06	0,10-0,15	0,10-0,20	0,10-0,30	30 (25-40)	50 (30-60)	60 (40-70)
P11	Pxx-EN3-06	0,10-0,15	0,10-0,20	0,10-0,30	30 (25-40)	50 (30-60)	60 (40-70)
P12	Pxx-EN3-06	0,10-0,15	0,10-0,20	0,10-0,30	25 (20-30)	40 (25-45)	45 (30-55)
M1	Pxx-EN3-06	0,10-0,15	0,10-0,20	0,10-0,30	-	-	35 (25-40)
M2	Pxx-EN3-06	0,10-0,15	0,10-0,20	0,10-0,30	-	-	35 (25-40)
M3	Pxx-EN3-06	0,10-0,15	0,10-0,20	0,10-0,30	-	-	35 (25-40)
M4	Pxx-EN3-06	0,10-0,15	0,10-0,20	0,10-0,30	-	-	30 (25-40)
M5	Pxx-EN3-06	0,10-0,15	0,10-0,20	0,10-0,30	-	-	30 (25-40)
K1	Pxx-EN3-06	0,10-0,20	0,10-0,30	0,10-0,30	-	90 (80-100)	120 (80-150)
K2	Pxx-EN3-06	0,10-0,20	0,10-0,30	0,10-0,30	-	35 (25-50)	50 (25-70)
K3	Pxx-EN3-06	0,10-0,20	0,10-0,30	0,10-0,30	-	90 (80-100)	120 (80-150)
K4	Pxx-EN3-06	0,10-0,20	0,10-0,30	0,10-0,30	-	70 (60-80)	90 (80-100)
K5	Pxx-EN3-06	0,10-0,20	0,10-0,30	0,10-0,30	-	70 (60-80)	90 (80-100)
K6	Pxx-EN3-06	0,10-0,20	0,10-0,30	0,10-0,30	-	90 (80-100)	120 (80-150)
K7	Pxx-EN3-06	0,10-0,20	0,10-0,30	0,10-0,30	-	90 (80-100)	120 (80-150)
PM1	Pxx-EN3-06	0,10-0,20	0,10-0,30	0,10-0,30	-	50 (25-70)	-
PM2	Pxx-EN3-06	0,10-0,20	0,10-0,30	0,10-0,30	-	50 (25-70)	-
PM3	Pxx-EN3-06	0,10-0,20	0,10-0,30	0,10-0,30	-	50 (25-70)	-

SMG = Gruppo materiale Seco

a_p = mm

f = mm/rev

v_c = m/min

Tutti i parametri di taglio sono valori di partenza

Introduzione

Foratura

Alesatura

Barenatura

Allegato

Parametri di taglio – Pxx-E3-06 pollici

SMG		a_p (°)		f	v_c		
		$\emptyset < 9$	$\emptyset \geq 9$		H15	CP20	CP15
P1	Pxx-EN3-06	0.004-0.006	0.004-0.008	0.004-0.012	130 (100-195)	345 (295-395)	395 (295-490)
P2	Pxx-EN3-06	0.004-0.006	0.004-0.008	0.004-0.012	130 (100-195)	345 (295-395)	395 (295-490)
P3	Pxx-EN3-06	0.004-0.006	0.004-0.008	0.004-0.012	130 (100-195)	345 (295-395)	395 (295-490)
P4	Pxx-EN3-06	0.004-0.006	0.004-0.008	0.004-0.012	115 (80-130)	195 (130-230)	260 (195-330)
P5	Pxx-EN3-06	0.004-0.006	0.004-0.008	0.004-0.012	115 (80-130)	195 (130-230)	260 (195-330)
P6	Pxx-EN3-06	0.004-0.006	0.004-0.008	0.004-0.012	115 (80-130)	195 (130-230)	260 (195-330)
P7	Pxx-EN3-06	0.004-0.006	0.004-0.008	0.004-0.012	115 (80-130)	195 (130-230)	260 (195-330)
P8	Pxx-EN3-06	0.004-0.006	0.004-0.008	0.004-0.012	100 (80-130)	165 (100-195)	195 (130-230)
P11	Pxx-EN3-06	0.004-0.006	0.004-0.008	0.004-0.012	100 (80-130)	165 (100-195)	195 (130-230)
P12	Pxx-EN3-06	0.004-0.006	0.004-0.008	0.004-0.012	80 (65-100)	130 (80-150)	150 (100-180)
M1	Pxx-EN3-06	0.004-0.006	0.004-0.008	0.004-0.012	-	-	115 (80-130)
M2	Pxx-EN3-06	0.004-0.006	0.004-0.008	0.004-0.012	-	-	115 (80-130)
M3	Pxx-EN3-06	0.004-0.006	0.004-0.008	0.004-0.012	-	-	115 (80-130)
M4	Pxx-EN3-06	0.004-0.006	0.004-0.008	0.004-0.012	-	-	100 (80-130)
M5	Pxx-EN3-06	0.004-0.006	0.004-0.008	0.004-0.012	-	-	100 (80-130)
K1	Pxx-EN3-06	0.004-0.008	0.004-0.012	0.004-0.012	-	295 (260-330)	395 (260-490)
K2	Pxx-EN3-06	0.004-0.008	0.004-0.012	0.004-0.012	-	115 (80-165)	165 (80-230)
K3	Pxx-EN3-06	0.004-0.008	0.004-0.012	0.004-0.012	-	295 (260-330)	395 (260-490)
K4	Pxx-EN3-06	0.004-0.008	0.004-0.012	0.004-0.012	-	230 (195-260)	295 (260-330)
K5	Pxx-EN3-06	0.004-0.008	0.004-0.012	0.004-0.012	-	230 (195-260)	295 (260-330)
K6	Pxx-EN3-06	0.004-0.008	0.004-0.012	0.004-0.012	-	295 (260-330)	395 (260-490)
K7	Pxx-EN3-06	0.004-0.008	0.004-0.012	0.004-0.012	-	295 (260-330)	395 (260-490)
PM1	Pxx-EN3-06	0.004-0.008	0.004-0.012	0.004-0.012	-	165 (80-230)	-
PM2	Pxx-EN3-06	0.004-0.008	0.004-0.012	0.004-0.012	-	165 (80-230)	-
PM3	Pxx-EN3-06	0.004-0.008	0.004-0.012	0.004-0.012	-	165 (80-230)	-

SMG = Gruppo materiale Seco

a_p = inch

f = in/rev

v_c = sf/min

Tutti i parametri di taglio sono valori di partenza

Introduzione

Foratura

Alesatura

Barenatura

Allegato

Parametri di taglio – Pxx-EN3-12 misure metriche

SMG		a_p (°)		f	v_c		
		$\varnothing < 9$	$\varnothing \geq 9$		H15	CP20	CP15
P1	Pxx-EN3-12	0,10-0,15	0,10-0,20	0,10-0,30	40 (30-60)	105 (90-120)	120 (90-150)
P2	Pxx-EN3-12	0,10-0,15	0,10-0,20	0,10-0,30	40 (30-60)	105 (90-120)	120 (90-150)
P3	Pxx-EN3-12	0,10-0,15	0,10-0,20	0,10-0,30	40 (30-60)	105 (90-120)	120 (90-150)
P4	Pxx-EN3-12	0,10-0,15	0,10-0,20	0,10-0,30	35 (25-40)	60 (40-70)	80 (60-100)
P5	Pxx-EN3-12	0,10-0,15	0,10-0,20	0,10-0,30	35 (25-40)	60 (40-70)	80 (60-100)
P6	Pxx-EN3-12	0,10-0,15	0,10-0,20	0,10-0,30	35 (25-40)	60 (40-70)	80 (60-100)
P7	Pxx-EN3-12	0,10-0,15	0,10-0,20	0,10-0,30	35 (25-40)	60 (40-70)	80 (60-100)
P8	Pxx-EN3-12	0,10-0,15	0,10-0,20	0,10-0,30	30 (25-40)	50 (30-60)	60 (40-70)
P11	Pxx-EN3-12	0,10-0,15	0,10-0,20	0,10-0,30	30 (25-40)	50 (30-60)	60 (40-70)
P12	Pxx-EN3-12	0,10-0,15	0,10-0,20	0,10-0,30	25 (20-30)	40 (25-45)	45 (30-55)
K1	Pxx-EN3-12	0,10-0,20	0,10-0,30	0,10-0,30	-	90 (80-100)	-
K3	Pxx-EN3-12	0,10-0,20	0,10-0,30	0,10-0,30	-	90 (80-100)	-
K4	Pxx-EN3-12	0,10-0,20	0,10-0,30	0,10-0,30	-	70 (60-80)	-
K5	Pxx-EN3-12	0,10-0,20	0,10-0,30	0,10-0,30	-	70 (60-80)	-
PM1	Pxx-EN3-12	0,10-0,20	0,10-0,30	0,10-0,30	-	50 (25-70)	-
PM2	Pxx-EN3-12	0,10-0,20	0,10-0,30	0,10-0,30	-	50 (25-70)	-
PM3	Pxx-EN3-12	0,10-0,20	0,10-0,30	0,10-0,30	-	50 (25-70)	-

SMG = Gruppo materiale Seco

a_p = mm

f = mm/rev

v_c = m/min

Tutti i parametri di taglio sono valori di partenza

Parametri di taglio – Pxx-EN3-12 pollici

SMG		a_p (°)		f	v_c		
		$\varnothing < 9$	$\varnothing \geq 9$		H15	CP20	CP15
P1	Pxx-EN3-12	0,004–0,006	0,004–0,008	0,004–0,012	130 (100-195)	345 (295-395)	395 (295-490)
P2	Pxx-EN3-12	0,004–0,006	0,004–0,008	0,004–0,012	130 (100-195)	345 (295-395)	395 (295-490)
P3	Pxx-EN3-12	0,004–0,006	0,004–0,008	0,004–0,012	130 (100-195)	345 (295-395)	395 (295-490)
P4	Pxx-EN3-12	0,004–0,006	0,004–0,008	0,004–0,012	115 (80-130)	195 (130-230)	260 (195-330)
P5	Pxx-EN3-12	0,004–0,006	0,004–0,008	0,004–0,012	115 (80-130)	195 (130-230)	260 (195-330)
P6	Pxx-EN3-12	0,004–0,006	0,004–0,008	0,004–0,012	115 (80-130)	195 (130-230)	260 (195-330)
P7	Pxx-EN3-12	0,004–0,006	0,004–0,008	0,004–0,012	115 (80-130)	195 (130-230)	260 (195-330)
P8	Pxx-EN3-12	0,004–0,006	0,004–0,008	0,004–0,012	100 (80-130)	165 (100-195)	195 (130-230)
P11	Pxx-EN3-12	0,004–0,006	0,004–0,008	0,004–0,012	100 (80-130)	165 (100-195)	195 (130-230)
P12	Pxx-EN3-12	0,004–0,006	0,004–0,008	0,004–0,012	80 (65-100)	130 (80-150)	150 (100-180)
K1	Pxx-EN3-12	0,004–0,008	0,004–0,012	0,004–0,012	-	295 (260-330)	-
K3	Pxx-EN3-12	0,004–0,008	0,004–0,012	0,004–0,012	-	295 (260-330)	-
K4	Pxx-EN3-12	0,004–0,008	0,004–0,012	0,004–0,012	-	230 (195-260)	-
K5	Pxx-EN3-12	0,004–0,008	0,004–0,012	0,004–0,012	-	230 (195-260)	-
PM1	Pxx-EN3-12	0,004–0,008	0,004–0,012	0,004–0,012	-	165 (80-230)	-
PM2	Pxx-EN3-12	0,004–0,008	0,004–0,012	0,004–0,012	-	165 (80-230)	-
PM3	Pxx-EN3-12	0,004–0,008	0,004–0,012	0,004–0,012	-	165 (80-230)	-

SMG = Gruppo materiale Seco

a_p = inch

f = in/rev

v_c = sf/min

Tutti i parametri di taglio sono valori di partenza

Istruzioni per la regolazione

<p>1.</p>		<p>Svitare le due viti di regolazione (7) di 1/4 di giro.</p>	Introduzione
<p>2.</p>		<p>Allentare le due viti di bloccaggio (5).</p>	Foratura
<p>3.</p>		<p>Togliere la lama, pulire accuratamente la sede, quindi ruotare la lama utilizzata (2) o sostituirla.</p>	Alesatura
<p>4.</p>		<p>Premere fermamente la lama contro il perno di appoggio assiale e le sfere di regolazione (6).</p>	Alesatura
<p>5.</p>		<p>Serrare moderatamente le viti di bloccaggio. (Per un corretto serraggio impugnare il lato corto della chiave).</p>	Barenatura
<p>6.</p>		<p>Azzerare l'indicatore del comparatore impiegando le guide cilindriche posteriori dei pattini di guida (3).</p>	Allegato

Istruzioni per la regolazione

Introduzione

Foratura

Alesatura

Barenatura

Allegato

7.



Regolare l'estremità posteriore della lama fino ad ottenere una rastremazione di 0,01 mm/10 mm (0,0004" per ogni 0,394") di lunghezza lama (vedere figura 2).

8.



Azzerare l'indicatore del comparatore impiegando le guide cilindriche posteriori dei pattini di guida (3).

9.



Posizionare l'estremità anteriore della lama di 0,02 mm o 0,015 mm (0,0008" o 0,0006") al di sopra dei pattini di guida (3) del comparatore A (vedere figura 1).
Controllare ancora il valore di rastremazione (passi 6 e 7) sul comparatore B.

10.

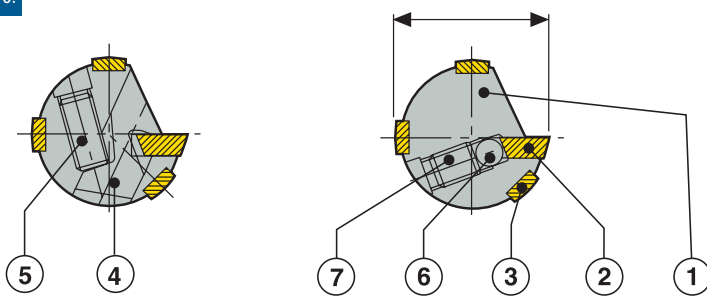

Nota: se durante la regolazione la quota prescritta viene superata, l'intera operazione deve essere ripetuta dall'inizio per annullare il gioco tra lama e viti di regolazione, che devono sempre lavorare in spinta.

figura 1

0,015 mm ($\varnothing \leq 10$ mm)
0,020 mm ($\varnothing > 10$ mm)
Valore comparatore A per regolazione \varnothing

0,0006" ($\varnothing \leq 0,394$ ")
0,0008" ($\varnothing > 0,394$ ")
Valore comparatore A per regolazione \varnothing

Comparator B Comparator A



figura 2

- Unità comparatore = 1 μ m (39 μ in)
- I valori relativi al comparatore anteriore ed al comparatore posteriore sono validi quando sul pattino adiacente è impostato lo zero.
- Valori comparatore posteriore calcolati su una rastremazione della lama di 1 μ m/mm (0,00004")

Tabella di regolazione			
Gamma diametri mm (pollici)	Dimensione lama	Fronte Comparatore A	Retro Comparatore B
6,875-8,749 (0,271-0,344")	P0	+15	-5
8,750-10,000 (0,344-0,394")	P1	+15	-5
10,001-12,749 (0,394-0,502")	P1	+20	0
12,750-19,499 (0,502-0,768")	P2	+20	0
19,500-60,500 (0,768-2,382")	P4	+20	0

Risoluzione dei problemi

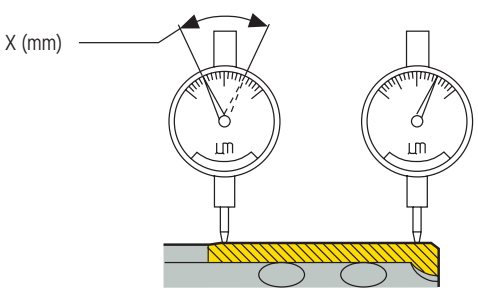
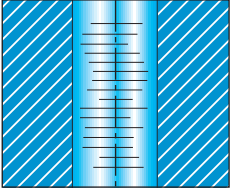
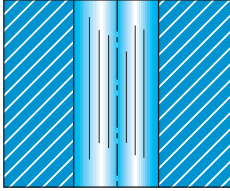
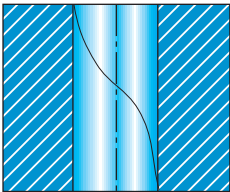
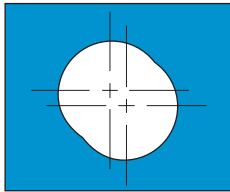
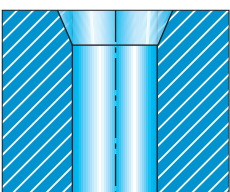
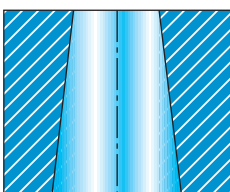
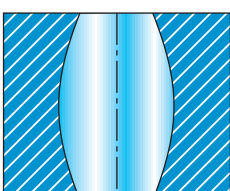
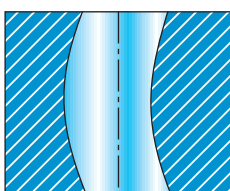
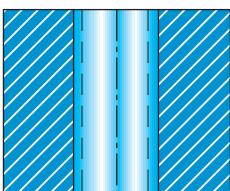
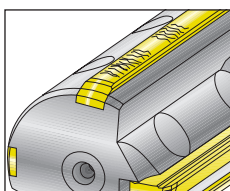
<p>Cattiva finitura superficiale</p> <ul style="list-style-type: none"> • Controllare il sovrametallo • Migliorare le condizioni di lubrefrigerazione (tipo di adduzione, pressione, qualità) • Ridurre l'avanzamento • Cambiare la lama (errata geometria d'imbocco o errato angolo di spoglia) • Controllare la posizione assiale della lama 	<p>Rigature</p> <ul style="list-style-type: none"> • Migliorare il centraggio (asse alesatore/foro) • Aumentare la rastremazione 	Introduzione
<p>Rigature di ritorno</p> <ul style="list-style-type: none"> • Migliorare le condizioni di lubrefrigerazione (tipo di adduzione, pressione, qualità) • Migliorare il centraggio (asse alesatore/foro) • Aumentare la rastremazione 	<p>Foro fuori centro/ovale</p> <ul style="list-style-type: none"> • Migliorare il serraggio (deformazione del pezzo) • Controllare il sovrametallo • Migliorare il centraggio (asse alesatore/foro) • Controllare la posizione assiale della lama 	Foratura
<p>Foro conico all'entrata</p> <ul style="list-style-type: none"> • Ridurre l'avanzamento • Migliorare il centraggio (asse alesatore/foro) • Controllare la rastremazione • Ridurre l'eccentricità radiale 	<p>Foro conico</p> <ul style="list-style-type: none"> • Migliorare il centraggio (asse alesatore/foro) • Controllare la rastremazione. 	Alesatura
<p>Foro deformato</p> <ul style="list-style-type: none"> • Migliorare il serraggio (deformazione del pezzo) 	<p>Foro deviato</p> <ul style="list-style-type: none"> • Cambiare la lama (errata geometria d'imbocco o errato angolo di spoglia) • Controllare la posizione assiale della lama 	Barenatura
<p>Foro maggiorato</p> <ul style="list-style-type: none"> • Migliorare il centraggio (asse alesatore/foro) • Regolare il diametro (troppo grande) 	<p>Incollamento pattini</p> <ul style="list-style-type: none"> • Migliorare le condizioni di lubrefrigerazione (tipo di adduzione, pressione, qualità) • Regolare il diametro (troppo piccolo) 	Allegato



Xfix™

Gli alesatori multi-tagliente Xfix™ offrono ottime prestazioni e precisione nella lavorazione di fori di grande diametro.

- Profondità del foro fino a 6,5xD entro un diametro compreso tra 39,5 e 154,5 mm (1,555-6,083")
- Regolazione semplice e rapida, per la regolazione del diametro è richiesta una sola vite per dente
- Sistema di regolazione accurato per ottenere tolleranze strette tra 16 e 25 µm (0,0006"-0,0010")
- Inserti dotati di quattro o otto taglienti numerati

Panoramica della gamma

	Gamma ∅	Profondità di alesatura	Tolleranza ∅ foro	Diametro intermedio	Finitura superficiale
<p>Xfix™</p> 	39,500-154,500 mm (1.5551-6.0827")	2,5-6,5 x D	IT 6	Disponibile tramite My Design	R _a 0,8-1,2 μm (R _a 31-47 μin)

Xfix™ è un programma Seco Reaming appositamente sviluppato, dedicato per dimensioni comprese tra ∅ 39,5 – 154,5 mm (1,555" – 6,083").

Il design include inserti regolabili e sostituibili per ottenere una tolleranza precisa IT 6 e un attacco regolabile incorporato per garantire la qualità dei componenti.

La struttura a denti multipli e i pattini di guida precaricati brevettati offrono la massima stabilità e produttività per operazioni di alesatura di ∅ grandi.

Caratteristiche specifiche

Introduzione

- 4 o 8 taglienti per l'ottimizzazione su tutti i materiali
- Stabile sistema di bloccaggio
- Facile regolazione mediante l'apposita vite
- Qualità e geometrie per differenti applicazioni

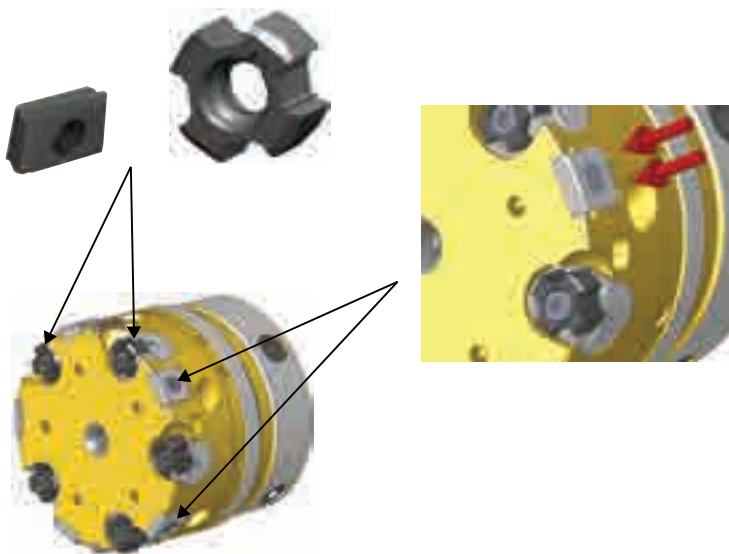

Foratura

- Pattini di guida precaricati brevettati per la massima stabilità applicativa
- Lubrificazione dei pattini per migliori prestazioni e sicurezza

Alesatura

- Adattatore regolabile integrato per un perfetto controllo dell'eccentricità

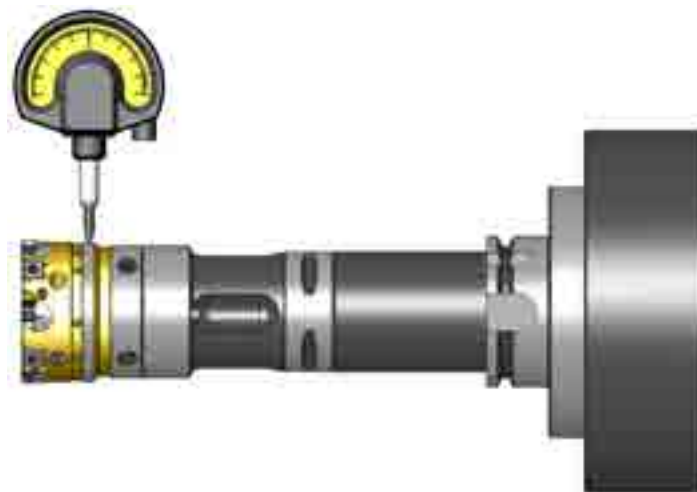

Barenatura

- Il programma di attacchi e prolunghe del catalogo Sistemi di Utensili Seco offre la massima modularità



Allegato

Chiavi di codifica

Adattatori

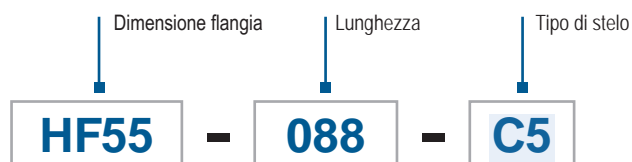

Testine standard

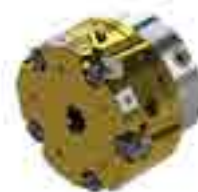
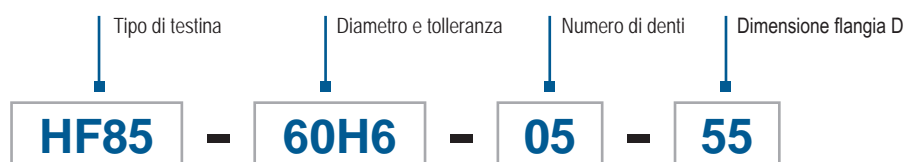

Testine intermedie

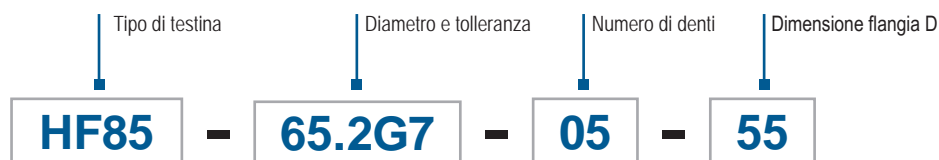

Informazioni sul tipo di testina:

- HF85, foro passante, materiale a truciolo corto
- HF85B, foro cieco, materiale a truciolo corto
- HF86, foro passante, tutti i materiali
- HF86B, foro cieco, tutti i materiali

Inseri

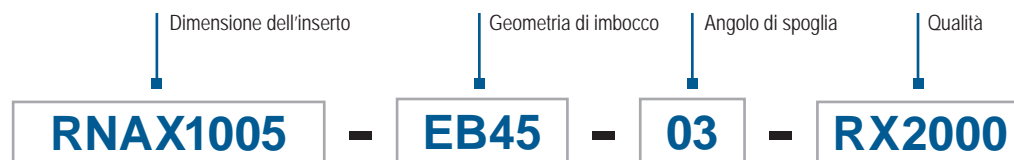

Inserto RNAX per testine Xfix HF85 e HF 85B

Inseri

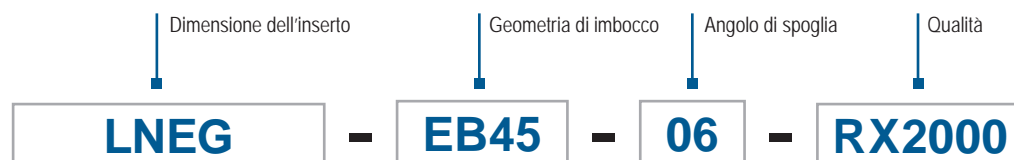

Inseri LNEG per testine Xfix HF86 e HF86B

RNAX

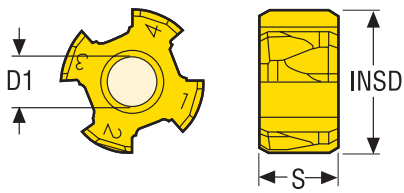

Codice di ordinazione	Inserti	INSD		S	D1	Qualità		Angolo di spoglia
		mm <i>Inch</i>	mm <i>Inch</i>			RX1500	RX2000	
RNAX1005-EB1570-03	RNAX	10,0 <i>0,394</i>	5,5 <i>0,217</i>	3,5 <i>0,138</i>	02687601	02687603	3 °	
RNAX1005-EB45-03	RNAX	10,0 <i>0,394</i>	5,5 <i>0,217</i>	3,5 <i>0,138</i>	02687600	02688608	3 °	
RNAX1005-EB845-03	RNAX	10,0 <i>0,394</i>	5,5 <i>0,217</i>	3,5 <i>0,138</i>	02687593	02688606	3 °	

LNEG

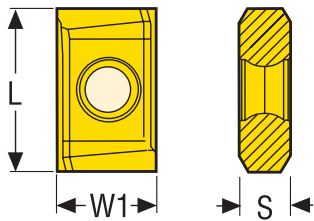

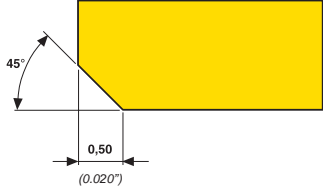
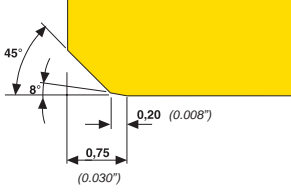
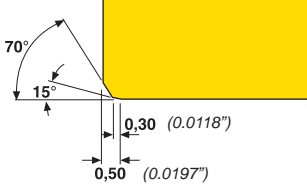

Codice di ordinazione	Inserti	L	S	W1	Qualità			Angolo di spoglia
					mm <i>Inch</i>	mm <i>Inch</i>	mm <i>Inch</i>	
LNEG1003-EB45-03	LNEG	10,0 <i>0,394</i>	3,5 <i>0,138</i>	6,35 <i>0,25</i>		02781311		3 °
LNEG1003-EB45-06	LNEG	10,0 <i>0,394</i>	3,5 <i>0,138</i>	6,35 <i>0,25</i>	02904277	02781313	02904276	6 °
LNEG1003-EB845-03	LNEG	10,0 <i>0,394</i>	3,5 <i>0,138</i>	6,35 <i>0,25</i>		02781314		3 °
LNEG1003-EB845-06	LNEG	10,0 <i>0,394</i>	3,5 <i>0,138</i>	6,35 <i>0,25</i>		02781315		6 °

Geometria di imbocco

Geometria di imbocco EB45 – Applicazione	
<p>Controllo truciolo +++ Finitura superficiale + R_a 1,2 - 2 μm (Finitura superficiale + R_a 0,047 - 0,0787 μin) Geometria prima scelta</p>	
Geometria di imbocco EB845 – Applicazione	
<p>Controllo truciolo ++ Finitura superficiale +++ R_a 0,4 - 1,2 μm (Finitura superficiale +++ R_a 0.0157 - 0,047 μin)</p>	
Geometria di imbocco EB1570 – Applicazione	
<p>Controllo truciolo ++ Finitura superficiale ++ R_a 0,8 - 1,6 μm (Finitura superficiale ++ R_a 0,031 - 0,0630 μin) Stabilità per applicazioni con lunghe sporgenze +++</p>	

Geometria di imbocco Qualità

Qualità		
	RX1500	Cermet rivestito Qualità rivestita resistente per l'ottimizzazione delle prestazioni su acciaio e ghisa.
	RX2000	Rivestita Qualità rivestita ad alte prestazioni per tutti i materiali da lavorare.
	CF	Cermet Qualità resistente all'usura per l'ottimizzazione delle prestazioni su acciaio.

HF85

Teste per inserti RNAX, foro passante \varnothing 39,5-59,499 mm / 1.555-2.342"

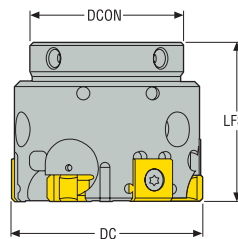

- Per inserti, qualità e geometrie, vedere le pagine 454-455
- Per i parametri di taglio raccomandati, vedere pagina(e) 480-487

Codice di ordinazione	DCN	DCX	LFS	DCON	Peso	Inserto
	mm Inch	mm Inch	mm Inch	mm Inch	kg lb	
HF85-39.5/44.499-03-32	39,5 1.555	44,499 1.752	33,0 1.299	32,0 1.260	0,41 0.900	3 RNAX1005...
HF85-44.5/49.499-03-32	44,5 1.752	49,499 1.949	33,0 1.299	32,0 1.260	0,51 1.120	3 RNAX1005...
HF85-49.5/54.499-03-32	49,5 1.949	54,499 2.146	33,0 1.299	32,0 1.260	0,62 1.370	3 RNAX1005...
HF85-54.5/59.499-03-32	54,5 2.146	59,499 2.342	33,0 1.299	32,0 1.260	0,74 1.630	3 RNAX1005...

Parti di ricambio, comprese nella fornitura

Per testa	Vite di regolazione	Cartuccia	Vite staffa	Vite di bloccaggio inserto	Chiave (a bandiera)	Chiave di regolazione	Cuneo di bloccaggio
HF85 03-32	SH4075S	CARTCYHF16	LDH4010	C03010-T09P	H2.0-2D	2SMS795	B6027

Accessori

Per testa	Chiave dinamometrica	Chiave Torx per vite di bloccaggio inserto/attacco
HF85 03-32	H00-2020	T00-09P20

Nota
Cacciavite dinamometrico H00-2020 per viti di bloccaggio

Cacciavite dinamometrico T00-09P20 per viti di bloccaggio inserto

Valore di coppia T00-09P20: 2 Nm.
Valore di coppia H00-2020: 2 Nm.

Introduzione

Foratura

Alesatura

Barenatura

Allegato

HF85B



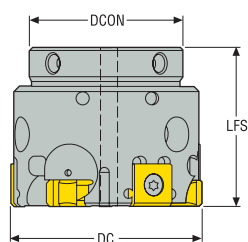



Teste per inserti RNAX, foro cieco Ø 39,5-59,499 mm / 1.555-2.342"





- Per inserti, qualità e geometrie, vedere le pagine 454-455
- Per i parametri di taglio raccomandati, vedere pagina(e) 480-487

Codice di ordinazione	DCN	DCX	LFS	DCON	Peso	Inserto
	mm Inch	mm Inch	mm Inch	mm Inch	kg lb	
HF85B-39.5/44.499-03-32	39,5 1.555	44,499 1.752	33,0 1.299	32,0 1.260	0,41 0.900	3 RNAX1005...
HF85B-44.5/49.499-03-32	44,5 1.752	49,499 1.949	33,0 1.299	32,0 1.260	0,51 1.120	3 RNAX1005...
HF85B-49.5/54.499-03-32	49,5 1.949	54,499 2.146	33,0 1.299	32,0 1.260	0,62 1.370	3 RNAX1005...
HF85B-54.5/59.499-03-32	54,5 2.146	59,499 2.342	33,0 1.299	32,0 1.260	0,74 1.630	3 RNAX1005...

Parti di ricambio, comprese nella fornitura

Per testa	Vite di regolazione	Cartuccia	Vite staffa	Vite di bloccaggio inserto	Chiave (a bandiera)	Chiave di regolazione	Cuneo di bloccaggio
							
HF85B 03-32	SH4075S	CARTCYHF16B	LDH4010	C03010-T09P	H2.0-2D	2SMS795	B6027

Accessori

Per testa	Chiave dinamometrica	Chiave Torx per vite di bloccaggio inserto/attacco
		
HF85B 03-32	H00-2020	T00-09P20

Nota

Cacciavite dinamometrico H00-2020 per viti di bloccaggio

Cacciavite dinamometrico T00-09P20 per viti di bloccaggio inserto

Valore di coppia T00-09P20: 2 Nm.

Valore di coppia H00-2020: 2 Nm.

HF86



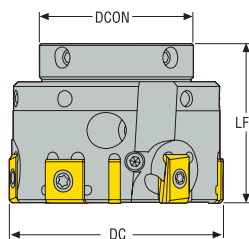



Teste per inserti LNEG, foro passante \varnothing 39,5-59,499 mm / 1.555-2.342"





- Per inserti, qualità e geometrie, vedere le pagine 454-455
- Per i parametri di taglio raccomandati, vedere pagina(e) 480-487

Codice di ordinazione	DCN	DCX	LFS	DCON	Peso	Inserto
	mm Inch	mm Inch	mm Inch	mm Inch	kg lb	
HF86-39.5/44.499-03-32	39,5 1.555	44,499 1.752	33,0 1.299	32,0 1.260	0,41 0.900	3 LNEG1003...
HF86-44.5/49.499-03-32	44,5 1.752	49,499 1.949	33,0 1.299	32,0 1.260	0,51 1.120	3 LNEG1003...
HF86-49.5/54.499-03-32	49,5 1.949	54,499 2.146	33,0 1.299	32,0 1.260	0,62 1.370	3 LNEG1003...
HF86-54.5/59.499-03-32	54,5 2.146	59,499 2.342	33,0 1.299	32,0 1.260	0,74 1.630	3 LNEG1003...

Parti di ricambio, comprese nella fornitura

Per testa	Vite di regolazione	Cartuccia	Vite staffa	Vite di bloccaggio inserto	Chiave (a bandiera)	Chiave di regolazione	Cuneo di bloccaggio
							
HF86 03-32	SH4075S	CARTCYLN16	LDH4010	C02506-T07P	H2.0-2D	2SMS795	B6027

Accessori

Per testa	Chiave dinamometrica	Chiave Torx per vite di bloccaggio inserto/attacco
		
HF86 03-32	H00-2020	T00-07P09

Nota
Cacciavite dinamometrico H00-2020 per viti di bloccaggio

Cacciavite dinamometrico T00-07P09 per viti di bloccaggio inserto

Valore di coppia T00-07P09: 0,9 Nm.
Valore di coppia H00-2020: 2 Nm.

Introduzione

Foratura

Alesatura

Barenatura

Allegato

HF86B



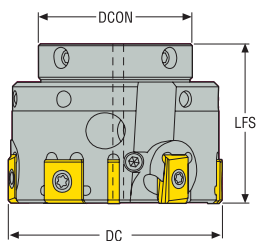



Teste per inserti LNEG, foro cieco Ø 39,5-59,499 mm / 1.555-2.342"





- Per inserti, qualità e geometrie, vedere le pagine 454-455
- Per i parametri di taglio raccomandati, vedere pagina(e) 480-487

Codice di ordinazione	DCN	DCX	LFS	DCON	Peso	Inserto
	mm Inch	mm Inch	mm Inch	mm Inch	kg lb	
HF86B-39.5/44.499-03-32	39,5 1.555	44,499 1.752	33,0 1.299	32,0 1.260	0,41 0.900	3 LNEG1003...
HF86B-44.5/49.499-03-32	44,5 1.752	49,499 1.949	33,0 1.299	32,0 1.260	0,51 1.120	3 LNEG1003...
HF86B-49.5/54.499-03-32	49,5 1.949	54,499 2.146	33,0 1.299	32,0 1.260	0,62 1.370	3 LNEG1003...
HF86B-54.5/59.499-03-32	54,5 2.146	59,499 2.342	33,0 1.299	32,0 1.260	0,74 1.630	3 LNEG1003...

Parti di ricambio, comprese nella fornitura

Per testa	Vite di regolazione	Cartuccia	Vite staffa	Vite di bloccaggio inserto	Chiave (a bandiera)	Chiave di regolazione	Cuneo di bloccaggio
							
HF86B 03-32	SH4075S	CARTCYLN16B	LDH4010	C02506-T07P	H2.0-2D	2SMS795	B6027

Accessori

Per testa	Chiave dinamometrica	Chiave Torx per vite di bloccaggio inserto/attacco
		
HF86B 03-32	H00-2020	T00-07P09

Nota
Cacciavite dinamometrico H00-2020 per viti di bloccaggio

Cacciavite dinamometrico T00-07P09 per viti di bloccaggio inserto

Valore di coppia T00-07P09: 0,9 Nm.

Valore di coppia H00-2020: 2 Nm.

HF32

Codolo Seco-Capto™ per Ø 39,5-59,499 mm

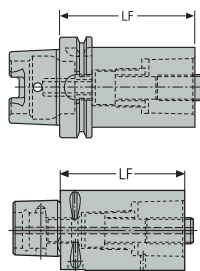

Prolunga

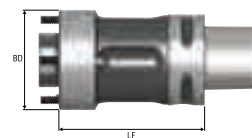

Attacco alesatore

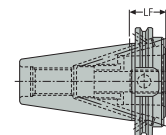

Codolo

Codice di ordinazione Adattatori alesatore	Codice prodotto	LF min	LF max	Cono	BD	Peso
		mm	mm	mm	mm	kg
HF32-050-C3	02688610	-	50	C3	32	0,3
HF32...HSKA63	-	65	245	HSK-A63	32	0,0
HF32...HSKA80	-	100	209	HSK-A80	32	0,0
HF32...HSKA100	-	70	245	HSK-A100	32	0,0
HF32...DIN40ADB	-	60	252	DIN40ADB	32	0,0
HF32...DIN50ADB	-	60	317	DIN50ADB	32	0,0
HF32...BT40ADB	-	65	252	BT40ADB	32	0,0
HF32...BT50ADB	-	75	317	BT50ADB	32	0,0

Codoli e prolunghes per HF32-050-C3 (vedere Catalogo Sistemi di Utensili per ulteriori dettagli).

Codice di ordinazione Attacco	Codice prodotto	LF	Cono	Dimensione Seco-Capto	Peso
		mm			kg
HA10-C3-032-080	10197961	80	HSK-A100	C3	2,5
HA06-C4-040-080	10197964	80	HSK-A63	C4	1,1
C3-390B.140-40030	02924104	30	DIN40	C3	0,8
C3-390B.55-40030	02925959	30	BT40	C3	1,0
C3-390B.55-40060	02925960	60	BT40	C3	1,1
C3-390B.140-50030	02924106	30	DIN50	C3	2,6
C3-390B.140-50060	02924107	60	DIN50	C3	2,7
C3-390B.58-50040	02925961	40	BT50	C3	3,5
C3-390B.58-50070	02925962	70	BT50	C3	3,7

Codice di ordinazione Prolunga	Codice prodotto	LF	Cono	Dimensione Seco-Capto	Peso
		mm			kg
C3-391.01-32060A	75039884	-	C3	C3	0,4
C3-391.01-32080A	00090847	-	C3	C3	0,5
C4-391.02-32055A	75039889	-	C4	C3	0,42
C4-391.02-32070A	02535687	-	C4	C3	0,56
C5-391.02-32060A	75039890	-	C5	C3	0,7
C6-391.02-32070A	75039892	-	C6	C3	1,1

Introduzione

Foratura

Alesatura

Barenatura

Allegato

HF32

Attacchi/adattatori Graflex® per Ø 39,5-59,499 in mm

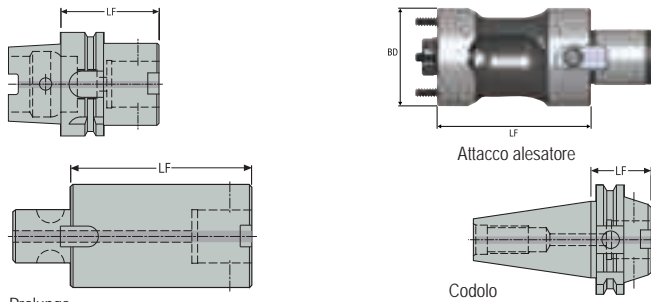

Prolunga

Attacco alesatore

Codolo

Codice di ordinazione Adattatori alesatore	Codice prodotto	LF min	LF max	Cono	BD	Peso
		mm	mm		mm	kg
HF32-050-G3	02698870	-	50	G3	32	0,4
HF32...HSKA63	-	65	245	HSK-A63	32	0,0
HF32...HSKA80	-	100	209	HSK-A80	32	0,0
HF32...HSKA100	-	70	245	HSK-A100	32	0,0
HF32...DIN40ADB	-	60	252	DIN40ADB	32	0,0
HF32...DIN50ADB	-	60	317	DIN50ADB	32	0,0
HF32...BT40ADB	-	65	252	BT40ADB	32	0,0
HF32...BT50ADB	-	75	317	BT50ADB	32	0,0

Codoli e prolunghes per HF32-050-G3 (vedere Catalogo Sistemi di Utensili per ulteriori dettagli).

Codice di ordinazione Attacco	Codice prodotto	LF	Cono	Dimensione Graflex	Peso
		mm			kg
EM93044011850	00086918	50	HSK-A63	G3	0,73
EM93064011855	00086925	55	HSK-A100	G3	2,2
EM34694011835	02420097	35	DIN40	G3	1,0
EM346940118100	02503298	100	DIN40	G3	1,22
EM34144011840	02503366	40	BT40	G3	1,07
EM341440118100	02503367	100	BT40	G3	1,31
EM34714011835	02503307	35	DIN50	G3	2,67
EM34164011845	02503376	45	BT50	G3	3,6
EM341640118120	02503377	120	BT50	G3	4,0

Codice di ordinazione Prolunga	Codice prodotto	LF	Cono	Dimensione Graflex	Peso
		mm			kg
M402330	00056758	-	G3	G3	0,3
M402331	75056759	-	G3	G3	0,4

Introduzione

Foratura

Alesatura

Barenatura

Allegato

HF85

Teste per inserti RNAX, foro passante \varnothing 59,5-84,499 mm / 2.343-3.327"

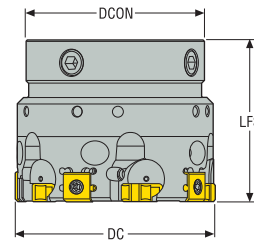

- Per inserti, qualità e geometrie, vedere le pagine 454-455
- Per i parametri di taglio raccomandati, vedere pagina(e) 480-487

Codice di ordinazione	DCN	DCX	LFS	DCON	Peso	Inserto
	mm Inch	mm Inch	mm Inch	mm Inch	kg lb	
HF85-59.5/64.499-05-55	59,5 2.343	64,499 2.539	50,0 1.969	55,0 2.165	1,3 2.870	5 RNAX1005...
HF85-64.5/69.499-05-55	64,5 2.539	69,499 2.736	50,0 1.969	55,0 2.165	1,5 3.310	5 RNAX1005...
HF85-69.5/74.499-05-55	69,5 2.736	74,499 2.933	50,0 1.969	55,0 2.165	1,75 3.860	5 RNAX1005...
HF85-74.5/79.499-05-55	74,5 2.933	79,499 3.130	50,0 1.969	55,0 2.165	2,0 4.410	5 RNAX1005...
HF85-79.5/84.499-05-55	79,5 3.130	84,499 3.327	50,0 1.969	55,0 2.165	2,2 4.850	5 RNAX1005...

Parti di ricambio, comprese nella fornitura

Per testa	Vite di regolazione	Cartuccia	Vite staffa	Vite di bloccaggio inserto	Chiave (a bandiera)	Chiave di regolazione	Cuneo di bloccaggio
HF85 05-55	SH4075S	CARTCYHF20	LDH4012	C03010-T09P	H2.0-2D	4SMS795	B6027

Accessori

Per testa	Chiave dinamometrica	Chiave Torx per viti di bloccaggio inserto/attacco
HF85 05-55	H00-2020	T00-09P20

Nota

Cacciavite dinamometrico [H00-2020](#) per viti di bloccaggio

Cacciavite dinamometrico [T00-09P20](#) per viti di bloccaggio inserto

Valore di coppia T00-09P20: 2 Nm.

Valore di coppia H00-2020: 2 Nm.

HF85B

Teste per inserti RNAX, foro cieco Ø 59,5-84,499 mm / 2.343-3.327"

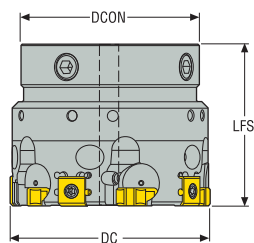



- Per inserti, qualità e geometrie, vedere le pagine 454-455
- Per i parametri di taglio raccomandati, vedere pagina(e) 480-487

Codice di ordinazione	DCN	DCX	LFS	DCON	Peso	Inserto
	mm <i>Inch</i>	mm <i>Inch</i>	mm <i>Inch</i>	mm <i>Inch</i>	kg <i>lb</i>	
HF85B-59.5/64.499-05-55	59,5 <i>2.343</i>	64,499 <i>2.539</i>	50,0 <i>1.969</i>	55,0 <i>2.165</i>	1,3 <i>2.870</i>	5 RNAX1005...
HF85B-64.5/69.499-05-55	64,5 <i>2.539</i>	69,499 <i>2.736</i>	50,0 <i>1.969</i>	55,0 <i>2.165</i>	1,5 <i>3.310</i>	5 RNAX1005...
HF85B-69.5/74.499-05-55	69,5 <i>2.736</i>	74,499 <i>2.933</i>	50,0 <i>1.969</i>	55,0 <i>2.165</i>	1,75 <i>3.860</i>	5 RNAX1005...
HF85B-74.5/79.499-05-55	74,5 <i>2.933</i>	79,499 <i>3.130</i>	50,0 <i>1.969</i>	55,0 <i>2.165</i>	2,0 <i>4.410</i>	5 RNAX1005...
HF85B-79.5/84.499-05-55	79,5 <i>3.130</i>	84,499 <i>3.327</i>	50,0 <i>1.969</i>	55,0 <i>2.165</i>	2,2 <i>4.850</i>	5 RNAX1005...

Parti di ricambio, comprese nella fornitura

Per testa	Vite di regolazione	Cartuccia	Vite staffa	Vite di bloccaggio inserto	Chiave (a bandiera)	Chiave di regolazione	Cuneo di bloccaggio
							
HF85B 05-55	SH4075S	CARTCYHF20B	LDH4012	C03010-T09P	H2.0-2D	2SMS795	B6027

Accessori

Per testa	Chiave dinamometrica	Chiave Torx per vite di bloccaggio inserto/attacco
		
HF85B 05-55	H00-2020	T00-09P20

Nota

Cacciavite dinamometrico H00-2020 per viti di bloccaggio

Cacciavite dinamometrico T00-09P20 per viti di bloccaggio inserto

Valore di coppia T00-09P20: 2 Nm.

Valore di coppia H00-2020: 2 Nm.

HF86



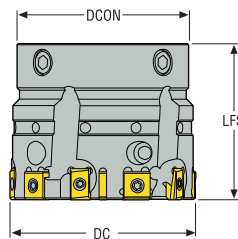



Teste per inserti LNEG, foro passante \varnothing 59,5-84,499 mm / 2.343-3.327"





- Per inserti, qualità e geometrie, vedere le pagine 454-455
- Per i parametri di taglio raccomandati, vedere pagina(e) 480-487

Codice di ordinazione	DCN	DCX	LFS	DCON	Peso	Inserto
	mm <i>Inch</i>	mm <i>Inch</i>	mm <i>Inch</i>	mm <i>Inch</i>	kg <i>lb</i>	
HF86-59.5-64.499-05-55	59,5 2.343	64,499 2.539	50,0 1.969	55,0 2.165	1,3 2.870	5 LNEG1003...
HF86-64.5-69.499-05-55	64,5 2.539	69,499 2.736	50,0 1.969	55,0 2.165	1,5 3.310	5 LNEG1003...
HF86-69.5-74.499-05-55	69,5 2.736	74,499 2.933	50,0 1.969	55,0 2.165	1,75 3.860	5 LNEG1003...
HF86-74.5-79.499-05-55	74,5 2.933	79,499 3.130	50,0 1.969	55,0 2.165	2,0 4.410	5 LNEG1003...
HF86-79.5-84.499-05-55	79,5 3.130	84,499 3.327	50,0 1.969	55,0 2.165	2,2 4.850	5 LNEG1003...

Parti di ricambio, comprese nella fornitura

Per testa	Vite di regolazione	Cartuccia	Vite staffa	Vite di bloccaggio inserto	Chiave (a bandiera)	Chiave di regolazione	Cuneo di bloccaggio
							
HF86 05-55	SH4075S	CARTCYLN20	LDH4010	C02506-T07P	H2.0-2D	2SMS795	B6027

Accessori

Per testa	Chiave dinamometrica	Chiave Torx per viti di bloccaggio inserto/attacco
		
HF86 05-55	H00-2020	T00-07P09

Nota

Cacciavite dinamometrico H00-2020 per viti di bloccaggio

Cacciavite dinamometrico T00-07P09 per viti di bloccaggio inserto

Valore di coppia T00-07P09: 0,9 Nm.

Valore di coppia H00-2020: 2 Nm.

HF86B



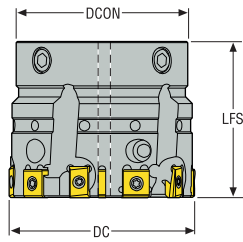



Teste per inserti LNEG, foro cieco Ø 59,5-84,499 mm / 2.343-3.327"





- Per inserti, qualità e geometrie, vedere le pagine 454-455
- Per i parametri di taglio raccomandati, vedere pagina(e) 480-487

Codice di ordinazione	DCN	DCX	LFS	DCON	Peso	Inserto
	mm <i>Inch</i>	mm <i>Inch</i>	mm <i>Inch</i>	mm <i>Inch</i>	kg <i>lb</i>	
HF86B-59.5/64.499-05-55	59,5 <i>2.343</i>	64,499 <i>2.539</i>	50,0 <i>1.969</i>	55,0 <i>2.165</i>	1,3 <i>2.870</i>	5 LNEG1003...
HF86B-64.5/69.499-05-55	64,5 <i>2.539</i>	69,499 <i>2.736</i>	50,0 <i>1.969</i>	55,0 <i>2.165</i>	1,5 <i>3.310</i>	5 LNEG1003...
HF86B-69.5/74.499-05-55	69,5 <i>2.736</i>	74,499 <i>2.933</i>	50,0 <i>1.969</i>	55,0 <i>2.165</i>	1,75 <i>3.860</i>	5 LNEG1003...
HF86B-74.5/79.499-05-55	74,5 <i>2.933</i>	79,499 <i>3.130</i>	50,0 <i>1.969</i>	55,0 <i>2.165</i>	2,0 <i>4.410</i>	5 LNEG1003...
HF86B-79.5/84.499-05-55	79,5 <i>3.130</i>	84,499 <i>3.327</i>	50,0 <i>1.969</i>	55,0 <i>2.165</i>	2,2 <i>4.850</i>	5 LNEG1003...

Parti di ricambio, comprese nella fornitura

Per testa	Vite di regolazione	Cartuccia	Vite staffa	Vite di bloccaggio inserto	Chiave (a bandiera)	Chiave di regolazione	Cuneo di bloccaggio
							
HF86B 05-55	SH4075S	CARTCYLN20B	LDH4010	C02506-T07P	H2.0-2D	2SMS795	B6027

Accessori

Per testa	Chiave dinamometrica	Chiave Torx per vite di bloccaggio inserto/attacco
		
HF86B 05-55	H00-2020	T00-07P09

Nota

Cacciavite dinamometrico H00-2020 per viti di bloccaggio

Cacciavite dinamometrico T00-07P09 per viti di bloccaggio inserto

Valore di coppia T00-07P09: 0,9 Nm.

Valore di coppia H00-2020: 2 Nm.

HF55

Codolo Seco-Capto™ per Ø 59,5-84,499 mm

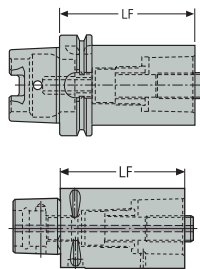

Prolunga

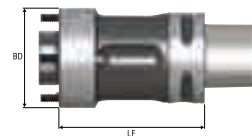

Attacco alesatore

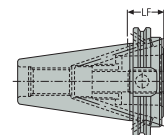

Codolo

Codice di ordinazione Adattatori alesatore	Codice prodotto	LF min	LF max	Cono	BD	Peso
		mm	mm		mm	kg
HF55-080-C5	02688647	-	80	C5	55	1,3
HF55...HSKA63	-	80	239	HSK-A63	55	0,0
HF55...HSKA80	-	100	239	HSK-A80	55	0,0
HF55...HSKA100	-	100	239	HSK-A100	55	0,0
HF55...DIN40ADB	-	80	239	DIN40ADB	55	0,0
HF55...DIN50ADB	-	80	304	DIN50ADB	55	0,0
HF55...BT40ADB	-	80	239	BT40ADB	55	0,0
HF55...BT50ADB	-	80	304	BT50ADB	55	0,0

Codoli e prolunghes per HF55-080-C5 (vedere Catalogo Sistemi di Utensili per ulteriori dettagli).

Codice di ordinazione Attacco	Codice prodotto	LF	Cono	Dimensione Seco-Capto	Peso
		mm			kg
HA10-C4-040-090	10197963	90	HSK-A100	C4	2,5
HA06-C5-050-090	10197966	90	HSK-A63	C5	3,1
C5-390B.140-40040	02924112	40	DIN40	C5	0,9
C5-390B.140-40080	02924113	80	DIN40	C5	1,5
C5-390B.55-40050	02925967	50	BT40	C5	1,1
C5-390B.55-40090	02925968	90	BT40	C5	1,7
C5-390B.140-50030	02924114	30	DIN50	C5	2,6
C5-390B.140-50070	02924115	70	DIN50	C5	3,1
C5-390B.58-50040	02925969	40	BT50	C5	3,5
C5-390B.58-50080	02925970	80	BT50	C5	3,9

Codice di ordinazione Prolunga	Codice prodotto	LF	Cono	Dimensione Seco-Capto	Peso
		mm			kg
C5-391.01-50080A	75039886	-	C5	C5	1,1
C5-391.01-50100A	00004773	-	C5	C5	1,39
C6-391.02-50080A	75039894	-	C6	C5	1,5
C6-391.02-50110A	02207400	-	C6	C5	2,2
C8-391.02-50080B	03080011	-	C8	C5	2,4

Introduzione

Foratura

Alesatura

Barenatura

Allegato

HF55

Attacchi/adattatori Graflex® per Ø 59,5-84,499 in mm

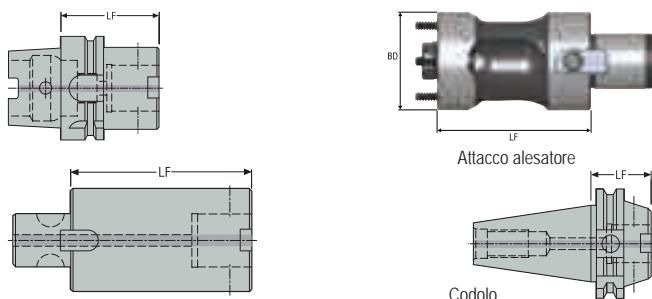

Prolunga

Attacco alesatore

Codolo

Codice di ordinazione Adattatori alesatore	Codice prodotto	LF min	LF max	Cono	BD	Peso
		mm	mm		mm	kg
HF55-080-G5	02698871	-	80	G5	55	1,3
HF55...HSKA63	-	80	239	HSK-A63	55	0,0
HF55...HSKA80	-	100	239	HSK-A80	55	0,0
HF55...HSKA100	-	100	239	HSK-A100	55	0,0
HF55...DIN40ADB	-	80	239	DIN40ADB	55	0,0
HF55...DIN50ADB	-	80	304	DIN50ADB	55	0,0
HF55...BT40ADB	-	80	239	BT40ADB	55	0,0
HF55...BT50ADB	-	80	304	BT50ADB	55	0,0

Codoli e prolunghes per HF55-080-G5 (vedere Catalogo Sistemi di Utensili per ulteriori dettagli).

Codice di ordinazione Attacco	Codice prodotto	LF	Cono	Dimensione Graflex	Peso
		mm			kg
EM93044012860	00086920	60	HSK-A63	G5	1,0
EM930440128100	00086921	100	HSK-A63	G5	1,6
EM930440128140	00086922	140	HSK-A63	G5	2,18
EM93064012865	00086927	65	HSK-A100	G5	2,37
EM930640128110	00086928	110	HSK-A100	G5	3,1
EM930640128150	00086929	150	HSK-A100	G5	3,7
EM34694012840	02458421	40	DIN40	G5	1,0
EM34694012880	02503301	80	DIN40	G5	1,5
EM346940128120	02503302	120	DIN40	G5	2,1
EM34144012845	02457989	45	BT40	G5	1,2
EM34144012880	02503371	80	BT40	G5	1,6
EM341440128120	02503372	120	BT40	G5	2,2
EM34714012840	02503312	40	DIN50	G5	2,75
EM341640128100	02503381	100	BT50	G5	4,3
EM34164012855	02503380	55	BT50	G5	4,0
EM341640128140	02503382	140	BT50	G5	4,9

Codice di ordinazione Prolunga	Codice prodotto	LF	Cono	Dimensione Graflex	Peso
		mm			kg
M402550	00056762	-	G5	G5	0,8
M402551	00056763	-	G5	G5	1,2
M402552	00056764	-	G5	G5	1,5

Introduzione

Foratura

Alesatura

Barenatura

Allegato

HF85

Teste per inserti RNAX, foro passante \varnothing 84,5-119,499 mm / 3.327-4.705"

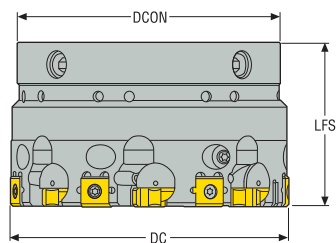
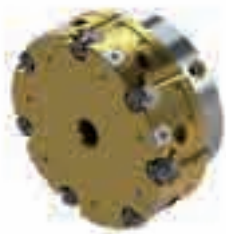

- Per inserti, qualità e geometrie, vedere le pagine 454-455
- Per i parametri di taglio raccomandati, vedere pagina(e) 480-487

Codice di ordinazione	DCN	DCX	LFS	DCON	Peso	Inserto
	mm <i>Inch</i>	mm <i>Inch</i>	mm <i>Inch</i>	mm <i>Inch</i>	kg <i>lb</i>	
HF85-84.5/89.499-07-80	84,5 3.327	89,499 3.524	50,0 1.969	80,0 3.150	1,68 3.700	7 RNAX1005...
HF85-89.5/94.499-07-80	89,5 3.524	94,499 3.720	50,0 1.969	80,0 3.150	1,85 4.080	7 RNAX1005...
HF85-94.5/99.499-07-80	94,5 3.720	99,499 3.917	50,0 1.969	80,0 3.150	2,02 4.450	7 RNAX1005...
HF85-99.5/104.499-07-80	99,5 3.917	104,499 4.114	50,0 1.969	80,0 3.150	2,2 4.850	7 RNAX1005...
HF85-104.5/109.499-07-80	104,5 4.114	109,499 4.311	50,0 1.969	80,0 3.150	2,4 5.290	7 RNAX1005...
HF85-109.5/114.499-07-80	109,5 4.311	114,499 4.508	50,0 1.969	80,0 3.150	2,61 5.750	7 RNAX1005...
HF85-114.5/119.499-07-80	114,5 4.508	119,499 4.705	50,0 1.969	80,0 3.150	2,82 6.220	7 RNAX1005...

Parti di ricambio, comprese nella fornitura

Per testa	Vite di regolazione	Cartuccia	Vite staffa	Vite di bloccaggio inserto	Chiave (a bandiera)	Chiave di regolazione	Cuneo di bloccaggio
HF85 07-80	SH4075S	CARTCYHF20	LDH4012	C03010-T09P	H2.0-2D	4SMS795	B6027

Accessori

Per testa	Chiave dinamometrica	Chiave Torx per viti di bloccaggio inserto/attacco
HF85 07-80	H00-2020	T00-09P20

Nota

Cacciavite dinamometrico H00-2020 per viti di bloccaggio

Cacciavite dinamometrico T00-09P20 per viti di bloccaggio inserto

Valore di coppia T00-09P20: 2 Nm.

Valore di coppia H00-2020: 2 Nm.

HF85B



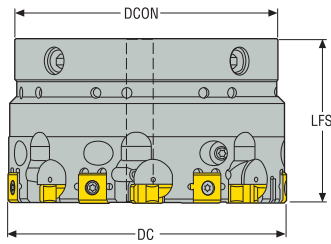



Teste per inserti RNAX, foro cieco Ø 84,5-119,499 mm / 3.327-4.705"





- Per inserti, qualità e geometrie, vedere le pagine 454-455
- Per i parametri di taglio raccomandati, vedere pagina(e) 480-487

Codice di ordinazione	DCN	DCX	LFS	DCON	Peso	Inserto
	mm <i>Inch</i>	mm <i>Inch</i>	mm <i>Inch</i>	mm <i>Inch</i>	kg <i>lb</i>	
HF85B-84.5/89.499-07-80	84,5 3.327	89,499 3.524	50,0 1.969	80,0 3.150	1,68 3.700	7
HF85B-89.5/94.499-07-80	89,5 3.524	94,499 3.720	50,0 1.969	80,0 3.150	1,85 4.080	7
HF85B-94.5/99.499-07-80	94,5 3.720	99,499 3.917	50,0 1.969	80,0 3.150	2,02 4.450	7
HF85B-99.5/104.499-07-80	99,5 3.917	104,499 4.114	50,0 1.969	80,0 3.150	2,2 4.850	7
HF85B-104.5/109.499-07-80	104,5 4.114	109,499 4.311	50,0 1.969	80,0 3.150	2,4 5.290	7
HF85B-109.5/114.499-07-80	109,5 4.311	114,499 4.508	50,0 1.969	80,0 3.150	2,61 5.750	7
HF85B-114.5/119.499-07-80	114,5 4.508	119,499 4.705	50,0 1.969	80,0 3.150	2,82 6.220	7

Parti di ricambio, comprese nella fornitura

Per testa	Vite di regolazione	Cartuccia	Vite staffa	Vite di bloccaggio inserto	Chiave (a bandiera)	Chiave di regolazione	Cuneo di bloccaggio
							
HF85B 07-80	SH4075S	CARTCYHF20B	LDH4010	C03010-T09P	H2.0-2D	2SMS795	B6027

Accessori

Per testa	Chiave dinamometrica	Chiave Torx per vite di bloccaggio inserto/attacco
		
HF85B 07-80	H00-2020	T00-09P20

Nota

Cacciavite dinamometrico H00-2020 per viti di bloccaggio

Cacciavite dinamometrico T00-09P20 per viti di bloccaggio inserto

Valore di coppia T00-09P20: 2 Nm.

Valore di coppia H00-2020: 2 Nm.

HF86

Teste per inserti LNEG, foro passante \varnothing 84,5-119,499 mm / 3.327-4.705"

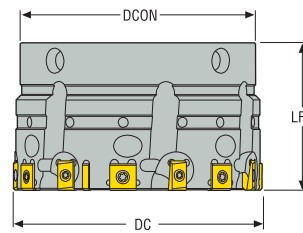
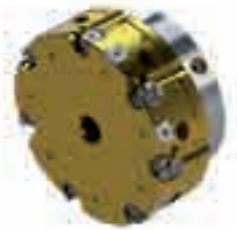

- Per inserti, qualità e geometrie, vedere le pagine 454-455
- Per i parametri di taglio raccomandati, vedere pagina(e) 480-487

Codice di ordinazione	DCN	DCX	LFS	DCON	Peso	Inserto
	mm <i>Inch</i>	mm <i>Inch</i>	mm <i>Inch</i>	mm <i>Inch</i>	kg <i>lb</i>	
HF86-84.5/89.499-07-80	84,5 3.327	89,499 3.524	50,0 1.969	80,0 3.150	1,68 3.700	7 LNEG1003...
HF86-89.5/94.499-07-80	89,5 3.524	94,499 3.720	50,0 1.969	80,0 3.150	1,85 4.080	7 LNEG1003...
HF86-94.5/99.499-07-80	94,5 3.720	99,499 3.917	50,0 1.969	80,0 3.150	2,02 4.450	7 LNEG1003...
HF86-99.5/104.499-07-80	99,5 3.917	104,499 4.114	50,0 1.969	80,0 3.150	2,2 4.850	7 LNEG1003...
HF86-104.5/109.499-07-80	104,5 4.114	109,499 4.311	50,0 1.969	80,0 3.150	2,4 5.290	7 LNEG1003...
HF86-109.5/114.499-07-80	109,5 4.311	114,499 4.508	50,0 1.969	80,0 3.150	2,61 5.750	7 LNEG1003...
HF86-114.5/119.499-07-80	114,5 4.508	119,499 4.705	50,0 1.969	80,0 3.150	2,82 6.220	7 LNEG1003...

Parti di ricambio, comprese nella fornitura

Per testa	Vite di regolazione	Cartuccia	Vite staffa	Vite di bloccaggio inserto	Chiave (a bandiera)	Chiave di regolazione	Cuneo di bloccaggio
HF86 07-80	SH4075S	CARTCYLN20	LDH4010	C02506-T07P	H2.0-2D	2SMS795	B6027

Accessori

Per testa	Chiave dinamometrica	Chiave Torx per viti di bloccaggio inserto/attacco
HF86 07-80	H00-2020	T00-07P09

Nota

Cacciavite dinamometrico H00-2020 per viti di bloccaggio

Cacciavite dinamometrico T00-07P09 per viti di bloccaggio inserto

Valore di coppia T00-07P09: 0,9 Nm.

Valore di coppia H00-2020: 2 Nm.

HF86B



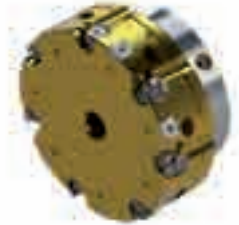
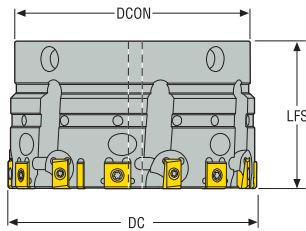



Teste per inserti LNEG, foro cieco Ø 84,5-119,499 mm / 3.327-4.705"





- Per inserti, qualità e geometrie, vedere le pagine 454-455
- Per i parametri di taglio raccomandati, vedere pagina(e) 480-487

Codice di ordinazione	DCN	DCX	LFS	DCON	Peso	Inserto
	mm <i>Inch</i>	mm <i>Inch</i>	mm <i>Inch</i>	mm <i>Inch</i>	kg <i>lb</i>	
HF86B-84.5/89.499-07-80	84,5 3.327	89,499 3.524	50,0 1.969	80,0 3.150	1,68 3.700	7
HF86B-89.5/94.499-07-80	89,5 3.524	94,499 3.720	50,0 1.969	80,0 3.150	1,85 4.080	7
HF86B-94.5/99.499-07-80	94,5 3.720	99,499 3.917	50,0 1.969	80,0 3.150	2,02 4.450	7
HF86B-99.5/104.499-07-80	99,5 3.917	104,499 4.114	50,0 1.969	80,0 3.150	2,2 4.850	7
HF86B-104.5/109.499-07-80	104,5 4.114	109,499 4.311	50,0 1.969	80,0 3.150	2,4 5.290	7
HF86B-109.5/114.499-07-80	109,5 4.311	114,499 4.508	50,0 1.969	80,0 3.150	2,61 5.750	7
HF86B-114.5/119.499-07-80	114,5 4.508	119,499 4.705	50,0 1.969	80,0 3.150	2,82 6.220	7

Parti di ricambio, comprese nella fornitura

Per testa	Vite di regolazione	Cartuccia	Vite staffa	Vite di bloccaggio inserto	Chiave (a bandiera)	Chiave di regolazione	Cuneo di bloccaggio
							
HF86B	SH4075S	CARTCYLN20B	LDH4010	C02506-T07P	H2.0-2D	2SMS795	B6027

Accessori

Per testa	Chiave dinamometrica	Chiave Torx per vite di bloccaggio inserto/attacco
		
HF86B	H00-2020	T00-07P09

Nota

Cacciavite dinamometrico H00-2020 per viti di bloccaggio

Cacciavite dinamometrico T00-07P09 per viti di bloccaggio inserto

Valore di coppia T00-07P09: 0,9 Nm.

Valore di coppia H00-2020: 2 Nm.

HF80

Codolo Seco-Capto™ per Ø 84,5-119,499 mm

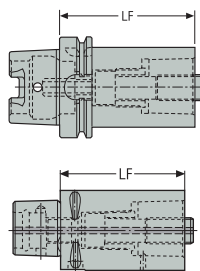

Prolunga

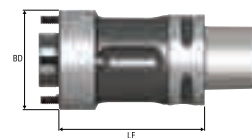

Attacco alesatore

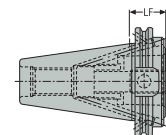

Codolo

Codice di ordinazione Adattatori alesatore	Codice prodotto	LF min	LF max	Cono	BD	Peso
		mm	mm		mm	kg
HF80-080-C6	02688648	-	80	C6	80	2,6
HF80...HSKA80	-	100	239	HSK-A80	80	0,0
HF80...HSKA100	-	100	239	HSK-A100	80	0,0
HF80...DIN50ADB	-	80	304	DIN50ADB	80	0,0
HF80...BT50ADB	-	80	304	BT50ADB	80	0,0

Codoli e prolunghes per HF80-080-C6 (vedere Catalogo Sistemi di Utensili per ulteriori dettagli).

Codice di ordinazione Attacco	Codice prodotto	LF	Cono	Dimensione Seco-Capto	Peso
		mm			kg
HA10-C6-063-110	10197967	110	HSK-A100	C6	3,8
C6-390B.140-40085	02924116	85	DIN40	C6	1,8
C6-390B.140-50030	02924117	30	DIN50	C6	2,4
C6-390B.140-50080	02924118	80	DIN50	C6	3,6
C6-390B.55-40075	02925971	75	BT40	C6	1,7
C6-390B.58-50100	02925973	100	BT50	C6	4,6
C6-390B.58-50050	02925972	50	BT50	C6	3,4

Codice di ordinazione Prolunga	Codice prodotto	LF	Cono	Dimensione Seco-Capto	Peso
		mm			kg
C6-391.01-63100A	75039887	-	C6	C6	2,2
C6-391.01-63140A	00004840	-	C6	C6	3,2
C6-391.01-63060	02300834	-	C6	C6	1,3

Introduzione

Foratura

Alesatura

Barenatura

Allegato

HF80

Attacchi/adattatori Graflex® per Ø 84,5-119,499 in mm

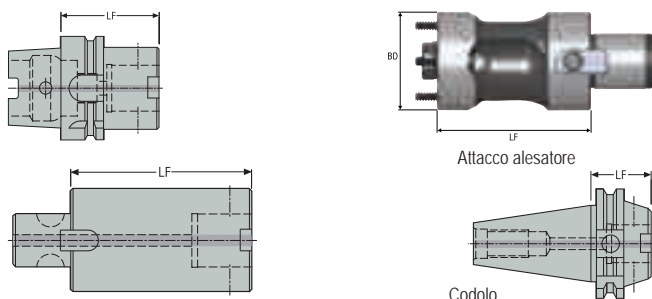

Prolunga

Attacco alesatore

Codolo



Codice di ordinazione Adattatori alesatore	Codice prodotto	LF min	LF max	Cono	BD	Peso
		mm	mm		mm	kg
HF80-080-G6	02698873	-	80	G6	80	2,6
HF80...HSKA80	-	100	239	HSK-A80	80	0,0
HF80...HSKA100	-	100	239	HSK-A100	80	0,0
HF80...DIN50ADB	-	80	304	DIN50ADB	80	0,0
HF80...BT50ADB	-	80	304	BT50ADB	80	0,0

Codoli e prolunghes per HF80-080-G6 (vedere Catalogo Sistemi di Utensili per ulteriori dettagli).

Codice di ordinazione Attacco	Codice prodotto	LF	Cono	Dimensione Graflex	Peso
		mm			kg
EM93044013670	00086923	70	HSK-A63	G6	1,3
EM930440136120	00086924	120	HSK-A63	G6	2,38
EM930640136120	00086931	120	HSK-A100	G6	3,9
EM930640136160	00086932	160	HSK-A100	G6	4,8
EM34694013660	02503303	60	DIN40	G6	1,3
EM346940136120	02503304	120	DIN40	G6	2,7
EM34144013650	02503373	50	BT40	G6	1,2
EM341440136120	02503374	120	BT40	G6	2,8
EM34714013645	02503317	45	DIN50	G6	2,9
EM347140136100	02503318	100	DIN50	G6	4,1
EM347140136140	02503319	140	DIN50	G6	5,1
EM34164013663	02503383	63	BT50	G6	4,3
EM341640136100	02503384	100	BT50	G6	4,7
EM341640136140	02503385	140	BT50	G6	5,6

Codoli e prolunghes per HF32-050-G3 (vedere Catalogo Sistemi di Utensili per ulteriori dettagli).

Codice di ordinazione Prolunga	Codice prodotto	LF	Cono	Dimensione Graflex	Peso
		mm			kg
M402660	00056765	-	G6	G6	1,4
M402661	00056766	-	G6	G6	2,2
M402662	00056767	-	G6	G6	2,9

Introduzione

Foratura

Alesatura

Barenatura

Allegato

HF85

Teste per inserti RNAX, foro passante \varnothing 119,5-154,499 mm / 4.705-6.083"

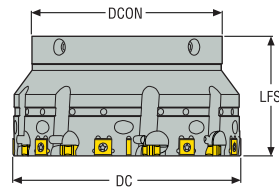

- Per inserti, qualità e geometrie, vedere le pagine 454-455
- Per i parametri di taglio raccomandati, vedere pagina(e) 480-487

Codice di ordinazione	DCN	DCX	LFS	DCON	Peso	Inserto
	mm Inch	mm Inch	mm Inch	mm Inch	kg lb	
HF85-119.5/124.499-09-100	119,5 4.705	124,499 4.902	63,0 2.480	100,0 3.937	3,89 8.580	9 RNAX1005...
HF85-124.5/129.499-09-100	124,5 4.902	129,499 5.098	63,0 2.480	100,0 3.937	4,15 9.150	9 RNAX1005...
HF85-129.5/134.499-09-100	129,5 5.098	134,499 5.295	63,0 2.480	100,0 3.937	4,42 9.740	9 RNAX1005...
HF85-134.5/139.499-09-100	134,5 5.295	139,499 5.492	63,0 2.480	100,0 3.937	4,7 10.360	9 RNAX1005...
HF85-139.5/144.499-09-100	139,5 5.492	144,499 5.689	63,0 2.480	100,0 3.937	4,99 11.000	9 RNAX1005...
HF85-144.5/149.499-09-100	144,5 5.689	149,499 5.886	63,0 2.480	100,0 3.937	5,29 11.660	9 RNAX1005...
HF85-149.5/154.499-09-100	149,5 5.886	154,499 6.083	63,0 2.480	100,0 3.937	5,6 12.350	9 RNAX1005...

Parti di ricambio, comprese nella fornitura

Per testa	Vite di regolazione	Cartuccia	Vite staffa	Vite di bloccaggio inserto	Chiave (a bandiera)	Chiave di regolazione	Cuneo di bloccaggio
HF85 09-100	SH4075S	CARTCYHF20	LDH4012	C03010-T09P	H2.0-2D	4SMS795	B6027

Accessori

Per testa	Chiave dinamometrica	Chiave Torx per vite di bloccaggio inserto/attacco
HF85 09-100	H00-2020	T00-09P20

Nota

Cacciavite dinamometrico H00-2020 per viti di bloccaggio

Cacciavite dinamometrico T00-09P20 per viti di bloccaggio inserto

Valore di coppia T00-09P20: 2 Nm.

Valore di coppia H00-2020: 2 Nm.

HF85B



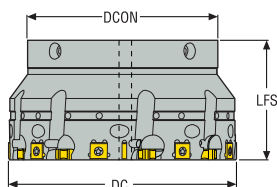



Teste per inserti RNAX, foro cieco Ø 119,5-154,499 mm / 4.705-6.083"





- Per inserti, qualità e geometrie, vedere le pagine 454-455
- Per i parametri di taglio raccomandati, vedere pagina(e) 480-487

Codice di ordinazione	DCN	DCX	LFS	DCON	Peso	Inserto
	mm <i>Inch</i>	mm <i>Inch</i>	mm <i>Inch</i>	mm <i>Inch</i>	kg <i>lb</i>	
HF85B-119.5/124.499-09-100	119,5 <i>4.705</i>	124,499 <i>4.902</i>	63,0 <i>2.480</i>	100,0 <i>3.937</i>	3,89 <i>8.580</i>	9 RNAX1005...
HF85B-124.5/129.499-09-100	124,5 <i>4.902</i>	129,499 <i>5.098</i>	63,0 <i>2.480</i>	100,0 <i>3.937</i>	4,15 <i>9.150</i>	9 RNAX1005...
HF85B-134.5/139.499-09-100	134,5 <i>5.295</i>	139,499 <i>5.492</i>	63,0 <i>2.480</i>	100,0 <i>3.937</i>	4,7 <i>10.360</i>	9 RNAX1005...
HF85B-139.5/144.499-09-100	139,5 <i>5.492</i>	144,499 <i>5.689</i>	63,0 <i>2.480</i>	100,0 <i>3.937</i>	4,99 <i>11.000</i>	9 RNAX1005...
HF85B-144.5/149.499-09-100	144,5 <i>5.689</i>	149,499 <i>5.886</i>	63,0 <i>2.480</i>	100,0 <i>3.937</i>	5,29 <i>11.660</i>	9 RNAX1005...
HF85B-149.5/154.499-09-100	149,5 <i>5.886</i>	154,499 <i>6.083</i>	63,0 <i>2.480</i>	100,0 <i>3.937</i>	5,6 <i>12.350</i>	9 RNAX1005...

Parti di ricambio, comprese nella fornitura

Per testa	Vite di regolazione	Cartuccia	Vite staffa	Vite di bloccaggio inserto	Chiave (a bandiera)	Chiave di regolazione	Cuneo di bloccaggio
							
HF85B 09-100	SH4075S	CARTCYHF20B	LDH4012	C03010-T09P	H2.0-2D	2SMS795	B6027

Accessori

Per testa	Chiave dinamometrica	Chiave Torx per vite di bloccaggio inserto/attacco
		
HF85B 09-100	H00-2020	T00-09P20

Nota

Cacciavite dinamometrico H00-2020 per viti di bloccaggio

Cacciavite dinamometrico T00-09P20 per viti di bloccaggio inserto

Valore di coppia T00-09P20: 2 Nm.

Valore di coppia H00-2020: 2 Nm.

HF86

Teste per inserti LNEG, foro passante \varnothing 119,5-154,499 mm / 4.705-6.083"

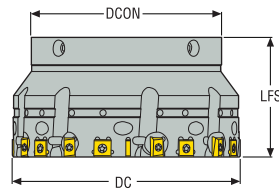

- Per inserti, qualità e geometrie, vedere le pagine 454-455
- Per i parametri di taglio raccomandati, vedere pagina(e) 480-487

Codice di ordinazione	DCN	DCX	LFS	DCON	Peso	Inserto
	mm <i>Inch</i>	mm <i>Inch</i>	mm <i>Inch</i>	mm <i>Inch</i>	kg <i>lb</i>	
HF86-119.5/124.499-09-100	119,5 4.705	124,499 4.902	63,0 2.480	100,0 3.937	3,89 8.580	9 LNEG1003...
HF86-124.5/129.499-09-100	124,5 4.902	129,499 5.098	63,0 2.480	100,0 3.937	4,15 9.150	9 LNEG1003...
HF86-129.5/134.499-09-100	129,5 5.098	134,499 5.295	63,0 2.480	100,0 3.937	4,42 9.740	9 LNEG1003...
HF86-134.5/139.499-09-100	134,5 5.295	139,499 5.492	63,0 2.480	100,0 3.937	4,7 10.360	9 LNEG1003...
HF86-139.5/144.499-09-100	139,5 5.492	144,499 5.689	63,0 2.480	100,0 3.937	4,99 11.000	9 LNEG1003...
HF86-144.5/149.499-09-100	144,5 5.689	149,499 5.886	63,0 2.480	100,0 3.937	5,29 11.660	9 LNEG1003...
HF86-149.5/154.499-09-100	149,5 5.886	154,499 6.083	63,0 2.480	100,0 3.937	5,6 12.350	9 LNEG1003...

Parti di ricambio, comprese nella fornitura

Per testa	Vite di regolazione	Cartuccia	Vite staffa	Vite di bloccaggio inserto	Chiave (a bandiera)	Chiave di regolazione	Cuneo di bloccaggio
HF86 09-100	SH4075S	CARTCYHF20	LDH4010	C02506-T07P	H2.0-2D	2SMS795	B6027

Accessori

Per testa	Chiave dinamometrica	Chiave Torx per viti di bloccaggio inserto/attacco
HF86 09-100	H00-2020	T00-07P09

Nota
Cacciavite dinamometrico H00-2020 per viti di bloccaggio

Cacciavite dinamometrico T00-07P09 per viti di bloccaggio inserto

Valore di coppia
T00-07P09: 0,9 Nm.
Valore di coppia H00-2020: 2 Nm.

Introduzione

Foratura

Alesatura

Barenatura

Allegato



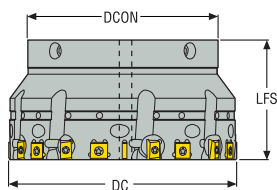



HF86B

 Teste per inserti LNEG, foro cieco \varnothing 119,5-154,499 mm / 4.705-6.083"



- Per inserti, qualità e geometrie, vedere le pagine 454-455
- Per i parametri di taglio raccomandati, vedere pagina(e) 480-487

Codice di ordinazione	DCN	DCX	LFS	DCON	Peso	Inserto
	mm <i>Inch</i>	mm <i>Inch</i>	mm <i>Inch</i>	mm <i>Inch</i>	kg <i>lb</i>	
HF86B-119.5/124.499-09-100	119,5 4.705	124,499 4.902	63,0 2.480	100,0 3.937	3,89 8.580	9 LNEG1003...
HF86B-124.5/129.499-09-100	124,5 4.902	129,499 5.098	63,0 2.480	100,0 3.937	4,15 9.150	9 LNEG1003...
HF86B-129.5/134.499-09-100	129,5 5.098	134,499 5.295	63,0 2.480	100,0 3.937	4,42 9.740	9 LNEG1003...
HF86B-134.5/139.499-09-100	134,5 5.295	139,499 5.492	63,0 2.480	100,0 3.937	4,7 10.360	9 LNEG1003...
HF86B-139.5/144.499-09-100	139,5 5.492	144,499 5.689	63,0 2.480	100,0 3.937	4,99 11.000	9 LNEG1003...
HF86B-144.5/149.499-09-100	144,5 5.689	149,499 5.886	63,0 2.480	100,0 3.937	5,29 11.660	9 LNEG1003...
HF86B-149.5/154.499-09-100	149,5 5.886	154,499 6.083	63,0 2.480	100,0 3.937	5,6 12.350	9 LNEG1003...

Parti di ricambio, comprese nella fornitura

Per testa	Vite di regolazione	Cartuccia	Vite staffa	Vite di bloccaggio inserto	Chiave (a bandiera)	Chiave di regolazione	Cuneo di bloccaggio
							
HF86B 09-100	SH4075S	CARTCYLN20B	LDH4010	C02506-T07P	H2.0-2D	2SMS795	B6027

Accessori

Per testa	Chiave dinamometrica	Chiave Torx per vite di bloccaggio inserto/attacco
		
HF86B 09-100	H00-2020	T00-07P09

Nota

Cacciavite dinamometrico H00-2020 per viti di bloccaggio

Cacciavite dinamometrico T00-07P09 per viti di bloccaggio inserto

Valore di coppia T00-07P09: 0,9 Nm.

Valore di coppia H00-2020: 2 Nm.

HF100

Codolo Seco-Capto™ per Ø 119,5-154,499 mm

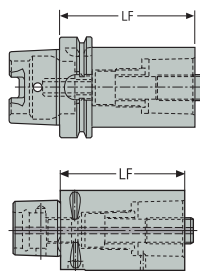

Prolunga



Attacco alesatore

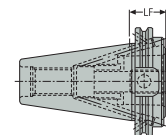

Codolo

Codice di ordinazione Adattatori alesatore	Codice prodotto	LF min	LF max	Cono	BD	Peso
		mm	mm		mm	kg
HF100-100-C8	02688649	-	100	C8	100	4,9
HF100...HSKA80	-	100	238	HSK-A80	100	0,0
HF100...HSKA100	-	100	238	HSK-A100	100	0,0
HF100...DIN50ADB	-	100	238	DIN50ADB	100	0,0
HF100...BT50ADB	-	100	238	BT50ADB	100	0,0

Codoli e prolunghes per HF100-100-C8 (vedere Catalogo Sistemi di Utensili per ulteriori dettagli).

Codice di ordinazione Attacco	Codice prodotto	LF	Cono	Dimensione Seco-Capto	Peso
		mm			kg
HA10-C8-080-120	10197968	120	HSK-A100	C8	4,1
C8-390B.140-50070	02924119	70	DIN50	C8	3,7
C8-390B.140-50120	02924120	120	DIN50	C8	5,6
C8-390B.58-50070	02925974	70	BT50	C8	4,0
C8-390B.58-50120	02925975	120	BT50	C8	5,9

Codice di ordinazione Prolunga	Codice prodotto	LF	Cono	Dimensione Seco-Capto	Peso
		mm			kg
C8-391.01-80100A	75039888	-	C8	C8	3,6
C8-391.01-80125A	00004841	-	C8	C8	4,7

Introduzione

Foratura

Alesatura

Barenatura

Allegato

HF100

Attacchi/adattatori Graflex® per Ø 119,5-154,499 in mm

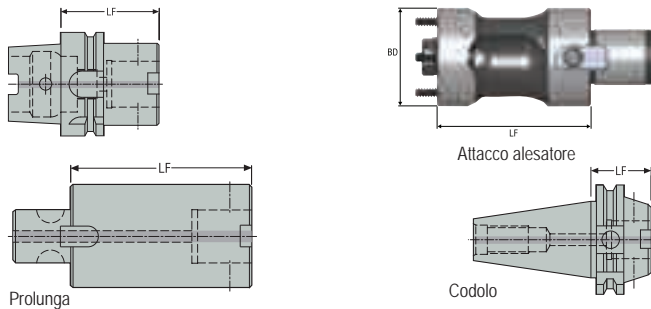

Codice di ordinazione Adattatori alesatore	Codice prodotto	LF min	LF max	Cono	BD	Peso
		mm	mm		mm	kg
HF100-100-G7	02698874	-	100	G7	100	5,2
HF100...HSKA80	-	100	238	HSK-A80	100	0,0
HF100...HSKA100	-	100	238	HSK-A100	100	0,0
HF100...DIN50ADB	-	100	238	DIN50ADB	100	0,0
HF100...BT50ADB	-	100	238	BT50ADB	100	0,0

Codoli e prolunghes per HF100-100-G7 (vedere Catalogo Sistemi di Utensili per ulteriori dettagli).

Codice di ordinazione Attacco	Codice prodotto	LF	Cono	Dimensione Graflex	Peso
		mm			kg
EM93064014685	00074385	85	HSK-A100	G7	4,0
EM930640146160	00086933	160	HSK-A100	G7	7,67
EM34714014650	02503320	50	DIN50	G7	3,3
EM347140146120	02503321	120	DIN50	G7	6,5
EM347140146200	02503324	200	DIN50	G7	10,4
EM34164014665	02503386	65	BT50	G7	4,4
EM341640146120	02503387	120	BT50	G7	6,9
EM341640146200	02503388	200	BT50	G7	10,7

Codice di ordinazione Prolunga	Codice prodotto	LF	Cono	Dimensione Graflex	Peso
		mm			kg
M402770	00056768	-	G7	G7	2,9
M402771	00056769	-	G7	G7	4,4
M402772	00056770	-	G7	G7	5,8

Introduzione

Foratura

Alesatura

Barenatura

Allegato

Parametri di taglio – LNEG...-EB45 misure metriche

SMG		$a_p (\varnothing)$	f				v_c			
			z=3	z=5	z=7	z=9	RX2000	CF	RX1500	
Introduzione	P1	LNEG1003-EB45	0,15-0,25	0,15-0,45	0,25-0,75	0,25-1,05	0,45-1,35	120 (80-200)	180 (120-250)	220 (120-300)
	P2	LNEG1003-EB45	0,15-0,25	0,15-0,45	0,25-0,75	0,25-1,05	0,45-1,35	120 (80-200)	180 (120-250)	220 (120-300)
	P3	LNEG1003-EB45	0,15-0,25	0,15-0,45	0,25-0,75	0,25-1,05	0,45-1,35	120 (80-200)	180 (120-250)	220 (120-300)
	P4	LNEG1003-EB45	0,15-0,25	0,15-0,45	0,25-0,75	0,25-1,05	0,45-1,35	60 (40-120)	80 (60-150)	100 (80-200)
	P5	LNEG1003-EB45	0,15-0,25	0,15-0,45	0,25-0,75	0,25-1,05	0,45-1,35	60 (40-120)	80 (60-150)	100 (80-200)
	P6	LNEG1003-EB45	0,15-0,25	0,15-0,45	0,25-0,75	0,25-1,05	0,45-1,35	60 (40-120)	80 (60-150)	100 (80-200)
	P7	LNEG1003-EB45	0,15-0,25	0,15-0,45	0,25-0,75	0,25-1,05	0,45-1,35	60 (40-120)	80 (60-150)	100 (80-200)
	P8	LNEG1003-EB45	0,15-0,25	0,15-0,45	0,25-0,75	0,25-1,05	0,45-1,35	40 (30-70)	60 (50-100)	80 (60-120)
Foratura	P11	LNEG1003-EB45	0,15-0,25	0,15-0,45	0,25-0,75	0,25-1,05	0,45-1,35	40 (30-70)	60 (50-100)	80 (60-120)
	P12	LNEG1003-EB45	0,15-0,25	0,15-0,45	0,25-0,75	0,25-1,05	0,45-1,35	30 (25-55)	45 (40-80)	65 (45-95)
	M1	LNEG1003-EB45	0,10-0,20	0,15-0,30	0,25-0,50	0,35-0,70	0,45-0,90	35 (25-60)	-	-
	M2	LNEG1003-EB45	0,10-0,20	0,15-0,30	0,25-0,50	0,35-0,70	0,45-0,90	35 (25-60)	-	-
	M3	LNEG1003-EB45	0,10-0,20	0,15-0,30	0,25-0,50	0,35-0,70	0,45-0,90	35 (25-60)	-	-
	M4	LNEG1003-EB45	0,10-0,20	0,15-0,30	0,25-0,50	0,35-0,70	0,45-0,90	25 (20-50)	-	-
	M5	LNEG1003-EB45	0,10-0,20	0,15-0,30	0,25-0,50	0,35-0,70	0,45-0,90	25 (20-50)	-	-
	K1	LNEG1003-EB45	0,20-0,50	0,15-0,45	0,25-0,75	0,25-1,05	0,45-1,35	100 (60-200)	-	220 (150-300)
Alesatura	K2	LNEG1003-EB45	0,20-0,50	0,15-0,45	0,25-0,75	0,25-1,05	0,45-1,35	50 (35-80)	-	70 (50-120)
	K3	LNEG1003-EB45	0,20-0,50	0,15-0,45	0,25-0,75	0,25-1,05	0,45-1,35	100 (60-200)	-	220 (150-300)
	K4	LNEG1003-EB45	0,20-0,50	0,15-0,45	0,25-0,75	0,25-1,05	0,45-1,35	70 (50-120)	100 (60-120)	150 (110-200)
	K5	LNEG1003-EB45	0,20-0,50	0,15-0,45	0,25-0,75	0,25-1,05	0,45-1,35	70 (50-120)	100 (60-120)	150 (110-200)
	K6	LNEG1003-EB45	0,20-0,50	0,15-0,45	0,25-0,75	0,25-1,05	0,45-1,35	100 (60-200)	-	220 (150-300)
	K7	LNEG1003-EB45	0,20-0,50	0,15-0,45	0,25-0,75	0,25-1,05	0,45-1,35	100 (60-200)	-	220 (150-300)
	H3	LNEG1003-EB45	0,10-0,20	0,1-0,25	0,15-0,40	0,25-0,5	0,30-0,7	20 (10-30)	-	-
	H5	LNEG1003-EB45	0,10-0,20	0,1-0,25	0,15-0,40	0,25-0,5	0,30-0,7	20 (10-30)	-	-
Barenatura	H7	LNEG1003-EB45	0,10-0,20	0,1-0,25	0,15-0,40	0,25-0,5	0,30-0,7	20 (10-30)	-	-
	H8	LNEG1003-EB45	0,10-0,20	0,1-0,25	0,15-0,40	0,25-0,5	0,30-0,7	20 (10-30)	-	-
	H11	LNEG1003-EB45	0,10-0,20	0,1-0,25	0,15-0,40	0,25-0,5	0,30-0,7	20 (10-30)	-	-
	H12	LNEG1003-EB45	0,10-0,20	0,1-0,25	0,15-0,40	0,25-0,5	0,30-0,7	20 (10-30)	-	-
	H21	LNEG1003-EB45	0,10-0,20	0,1-0,25	0,15-0,40	0,25-0,5	0,30-0,7	20 (10-30)	-	-
	H31	LNEG1003-EB45	0,10-0,20	0,1-0,25	0,15-0,40	0,25-0,5	0,30-0,7	20 (10-30)	-	-

SMG = Gruppo materiale Seco

a_p = mm

f = mm/rev

v_c = m/min

Tutti i parametri di taglio sono valori di partenza

Parametri di taglio – LNEG...-EB45 pollici

SMG		a_p (°)	f				v_c		
			z=3	z=5	z=7	z=9	RX2000	CF	RX1500
P1	LNEG1003-EB45	0.006-0.010	0.006-0.018	0.010-0.030	0.010-0.041	0.018-0.053	395 (260-655)	590 (395-820)	720 (395-985)
P2	LNEG1003-EB45	0.006-0.010	0.006-0.018	0.010-0.030	0.010-0.041	0.018-0.053	395 (260-655)	590 (395-820)	720 (395-985)
P3	LNEG1003-EB45	0.006-0.010	0.006-0.018	0.010-0.030	0.010-0.041	0.018-0.053	395 (260-655)	590 (395-820)	720 (395-985)
P4	LNEG1003-EB45	0.006-0.010	0.006-0.018	0.010-0.030	0.010-0.041	0.018-0.053	195 (130-395)	260 (195-490)	330 (260-655)
P5	LNEG1003-EB45	0.006-0.010	0.006-0.018	0.010-0.030	0.010-0.041	0.018-0.053	195 (130-395)	260 (195-490)	330 (260-655)
P6	LNEG1003-EB45	0.006-0.010	0.006-0.018	0.010-0.030	0.010-0.041	0.018-0.053	195 (130-395)	260 (195-490)	330 (260-655)
P7	LNEG1003-EB45	0.006-0.010	0.006-0.018	0.010-0.030	0.010-0.041	0.018-0.053	195 (130-395)	260 (195-490)	330 (260-655)
P8	LNEG1003-EB45	0.006-0.010	0.006-0.018	0.010-0.030	0.010-0.041	0.018-0.053	130 (100-230)	195 (165-330)	260 (195-395)
P11	LNEG1003-EB45	0.006-0.010	0.006-0.018	0.010-0.030	0.010-0.041	0.018-0.053	130 (100-230)	195 (165-330)	260 (195-395)
P12	LNEG1003-EB45	0.006-0.010	0.006-0.018	0.010-0.030	0.010-0.041	0.010-0.053	100 (85-185)	150 (135-265)	215 (150-315)
M1	LNEG1003-EB45	0.004-0.008	0.006-0.012	0.010-0.020	0.014-0.028	0.018-0.035	115 (80-195)	-	-
M2	LNEG1003-EB45	0.004-0.008	0.006-0.012	0.010-0.020	0.014-0.028	0.018-0.035	115 (80-195)	-	-
M3	LNEG1003-EB45	0.004-0.008	0.006-0.012	0.010-0.020	0.014-0.028	0.018-0.035	115 (80-195)	-	-
M4	LNEG1003-EB45	0.004-0.008	0.006-0.012	0.010-0.020	0.014-0.028	0.018-0.035	80 (65-165)	-	-
M5	LNEG1003-EB45	0.004-0.008	0.006-0.012	0.010-0.020	0.014-0.028	0.018-0.035	80 (65-165)	-	-
K1	LNEG1003-EB45	0.008-0.020	0.006-0.018	0.010-0.030	0.010-0.041	0.018-0.053	330 (195-655)	-	720 (490-985)
K2	LNEG1003-EB45	0.008-0.020	0.006-0.018	0.010-0.030	0.010-0.041	0.018-0.053	165 (115-260)	-	230 (165-395)
K3	LNEG1003-EB45	0.008-0.020	0.006-0.018	0.010-0.030	0.010-0.041	0.018-0.053	330 (195-655)	-	720 (490-985)
K4	LNEG1003-EB45	0.008-0.020	0.006-0.018	0.010-0.030	0.010-0.041	0.018-0.053	230 (165-395)	330 (195-395)	490 (360-655)
K5	LNEG1003-EB45	0.008-0.020	0.006-0.018	0.010-0.030	0.010-0.041	0.018-0.053	230 (165-395)	330 (195-395)	490 (360-655)
K6	LNEG1003-EB45	0.008-0.020	0.006-0.018	0.010-0.030	0.010-0.041	0.018-0.053	330 (195-655)	-	720 (490-985)
K7	LNEG1003-EB45	0.008-0.020	0.006-0.018	0.010-0.030	0.010-0.041	0.018-0.053	330 (195-655)	-	720 (490-985)
H3	LNEG1003-EB45	0.004-0.008	0.004-0.010	0.006-0.016	0.010-0.020	0.012-0.028	65 (35-100)	-	-
H5	LNEG1003-EB45	0.004-0.008	0.004-0.010	0.006-0.016	0.010-0.020	0.012-0.028	65 (35-100)	-	-
H7	LNEG1003-EB45	0.004-0.008	0.004-0.010	0.006-0.016	0.010-0.020	0.012-0.028	65 (35-100)	-	-
H8	LNEG1003-EB45	0.004-0.008	0.004-0.010	0.006-0.016	0.010-0.020	0.012-0.028	65 (35-100)	-	-
H11	LNEG1003-EB45	0.004-0.008	0.004-0.010	0.006-0.016	0.010-0.020	0.012-0.028	65 (35-100)	-	-
H12	LNEG1003-EB45	0.004-0.008	0.004-0.010	0.006-0.016	0.010-0.020	0.012-0.028	65 (35-100)	-	-
H21	LNEG1003-EB45	0.004-0.008	0.004-0.010	0.006-0.016	0.010-0.020	0.012-0.028	65 (35-100)	-	-
H31	LNEG1003-EB45	0.004-0.008	0.004-0.010	0.006-0.016	0.010-0.020	0.012-0.028	65 (35-100)	-	-

SMG = Gruppo materiale Seco

a_p = inch

f = in/rev

v_c = sf/min

Tutti i parametri di taglio sono valori di partenza

Introduzione

Foratura

Alesatura

Barenatura

Allegato

Parametri di taglio – LNEG...-EB845 misure metriche

SMG		a_p (∅)	f				v_c RX2000
			z=3	z=5	z=7	z=9	
P1	LNEG1003-EB845	0,15-0,25	0,15-0,60	0,25-1	0,35-1,4	0,45-1,80	120 (80-200)
P2	LNEG1003-EB845	0,15-0,25	0,15-0,60	0,25-1	0,35-1,4	0,45-1,80	120 (80-200)
P3	LNEG1003-EB845	0,15-0,25	0,15-0,60	0,25-1	0,35-1,4	0,45-1,80	120 (80-200)
P4	LNEG1003-EB845	0,15-0,25	0,15-0,60	0,25-1	0,35-1,4	0,45-1,80	60 (40-120)
P5	LNEG1003-EB845	0,15-0,25	0,15-0,60	0,25-1	0,35-1,4	0,45-1,80	60 (40-120)
P6	LNEG1003-EB845	0,15-0,25	0,15-0,60	0,25-1	0,35-1,4	0,45-1,80	60 (40-120)
P7	LNEG1003-EB845	0,15-0,25	0,15-0,60	0,25-1	0,35-1,4	0,45-1,80	60 (40-120)
P8	LNEG1003-EB845	0,15-0,25	0,15-0,60	0,25-1	0,35-1,4	0,45-1,80	40 (30-70)
P11	LNEG1003-EB845	0,15-0,25	0,15-0,60	0,25-1	0,35-1,4	0,45-1,80	40 (30-70)
P12	LNEG1003-EB845	0,15-0,25	0,15-0,60	0,25-1	0,35-1,4	0,45-1,80	30 (25-55)
M1	LNEG1003-EB845	0,10-0,20	0,15-0,45	0,25-0,75	0,25-1,05	0,45-1,35	35 (25-60)
M2	LNEG1003-EB845	0,10-0,20	0,15-0,45	0,25-0,75	0,25-1,05	0,45-1,35	35 (25-60)
M3	LNEG1003-EB845	0,10-0,20	0,15-0,45	0,25-0,75	0,25-1,05	0,45-1,35	35 (25-60)
M4	LNEG1003-EB845	0,10-0,20	0,15-0,45	0,25-0,75	0,25-1,05	0,45-1,35	25 (20-50)
M5	LNEG1003-EB845	0,10-0,20	0,15-0,45	0,25-0,75	0,25-1,05	0,45-1,35	25 (20-50)
K1	LNEG1003-EB845	0,20-0,50	0,15-0,60	0,25-1	0,35-1,4	0,45-1,80	100 (60-200)
K2	LNEG1003-EB845	0,20-0,50	0,15-0,60	0,25-1	0,35-1,4	0,45-1,80	50 (35-80)
K3	LNEG1003-EB845	0,20-0,50	0,15-0,60	0,25-1	0,35-1,4	0,45-1,80	100 (60-200)
K4	LNEG1003-EB845	0,20-0,50	0,15-0,60	0,25-1	0,35-1,4	0,45-1,80	70 (50-120)
K5	LNEG1003-EB845	0,20-0,50	0,15-0,60	0,25-1	0,35-1,4	0,45-1,80	70 (50-120)
K6	LNEG1003-EB845	0,20-0,50	0,15-0,60	0,25-1	0,35-1,4	0,45-1,80	100 (60-200)
K7	LNEG1003-EB845	0,20-0,50	0,15-0,60	0,25-1	0,35-1,4	0,45-1,80	100 (60-200)

SMG = Gruppo materiale Seco

a_p = mm

f = mm/rev

v_c = m/min

Tutti i parametri di taglio sono valori di partenza

Introduzione

Foratura

Alesatura

Barenatura

Allegato

Parametri di taglio – LNEG...-EB845 pollici

SMG		a_p (∅)	f				v_c RX2000
			z=3	z=5	z=7	z=9	
P1	LNEG1003-EB845	0.006-0.010	0.006-0.024	0.010-0.039	0.014-0.055	0.018-0.071	395 (260-655)
P2	LNEG1003-EB845	0.006-0.010	0.006-0.024	0.010-0.039	0.014-0.055	0.018-0.071	395 (260-655)
P3	LNEG1003-EB845	0.006-0.010	0.006-0.024	0.010-0.039	0.014-0.055	0.018-0.071	395 (260-655)
P4	LNEG1003-EB845	0.006-0.010	0.006-0.024	0.010-0.039	0.014-0.055	0.018-0.071	195 (130-395)
P5	LNEG1003-EB845	0.006-0.010	0.006-0.024	0.010-0.039	0.014-0.055	0.018-0.071	195 (130-395)
P6	LNEG1003-EB845	0.006-0.010	0.006-0.024	0.010-0.039	0.014-0.055	0.018-0.071	195 (130-395)
P7	LNEG1003-EB845	0.006-0.010	0.006-0.024	0.010-0.039	0.014-0.055	0.018-0.071	195 (130-395)
P8	LNEG1003-EB845	0.006-0.010	0.006-0.024	0.010-0.039	0.014-0.055	0.018-0.071	130 (100-230)
P11	LNEG1003-EB845	0.006-0.010	0.006-0.024	0.010-0.039	0.014-0.055	0.018-0.071	130 (100-230)
P12	LNEG1003-EB845	0.006-0.010	0.006-0.024	0.010-0.039	0.014-0.055	0.018-0.071	100 (85-185)
M1	LNEG1003-EB845	0.004-0.008	0.006-0.018	0.010-0.030	0.010-0.041	0.018-0.053	115 (80-195)
M2	LNEG1003-EB845	0.004-0.008	0.006-0.018	0.010-0.030	0.010-0.041	0.018-0.053	115 (80-195)
M3	LNEG1003-EB845	0.004-0.008	0.006-0.018	0.010-0.030	0.010-0.041	0.018-0.053	115 (80-195)
M4	LNEG1003-EB845	0.004-0.008	0.006-0.018	0.010-0.030	0.010-0.041	0.018-0.053	80 (65-165)
M5	LNEG1003-EB845	0.004-0.008	0.006-0.018	0.010-0.030	0.010-0.041	0.018-0.053	80 (65-165)
K1	LNEG1003-EB845	0.008-0.020	0.006-0.024	0.010-0.039	0.014-0.055	0.018-0.071	330 (195-655)
K2	LNEG1003-EB845	0.008-0.020	0.006-0.024	0.010-0.039	0.014-0.055	0.018-0.071	165 (115-260)
K3	LNEG1003-EB845	0.008-0.020	0.006-0.024	0.010-0.039	0.014-0.055	0.018-0.071	330 (195-655)
K4	LNEG1003-EB845	0.008-0.020	0.006-0.024	0.010-0.039	0.014-0.055	0.018-0.071	230 (165-395)
K5	LNEG1003-EB845	0.008-0.020	0.006-0.024	0.010-0.039	0.014-0.055	0.018-0.071	230 (165-395)
K6	LNEG1003-EB845	0.008-0.020	0.006-0.024	0.010-0.039	0.014-0.055	0.018-0.071	330 (195-655)
K7	LNEG1003-EB845	0.008-0.020	0.006-0.024	0.010-0.039	0.014-0.055	0.018-0.071	330 (195-655)

SMG = Gruppo materiale Seco

a_p = inch

f = in/rev

v_c = sf/min

Tutti i parametri di taglio sono valori di partenza

Introduzione

Foratura

Alesatura

Barenatura

Allegato

Parametri di taglio – LNEG...-EB1570 misure metriche

SMG		a_p (∅)	f				v_c RX2000
			z=3	z=5	z=7	z=9	
P4	LNEG1005-EB1570	0,15-0,25	0,15-0,45	0,25-0,75	0,25-1,05	0,45-1,35	60 (40-120)
P5	LNEG1005-EB1570	0,15-0,25	0,15-0,45	0,25-0,75	0,25-1,05	0,45-1,35	60 (40-120)
P6	LNEG1005-EB1570	0,15-0,25	0,15-0,45	0,25-0,75	0,25-1,05	0,45-1,35	60 (40-120)
P7	LNEG1005-EB1570	0,15-0,25	0,15-0,45	0,25-0,75	0,25-1,05	0,45-1,35	60 (40-120)
P8	LNEG1005-EB1570	0,15-0,25	0,15-0,45	0,25-0,75	0,25-1,05	0,45-1,35	40 (30-70)
P11	LNEG1005-EB1570	0,15-0,25	0,15-0,45	0,25-0,75	0,25-1,05	0,45-1,35	40 (30-70)
P12	LNEG1005-EB1570	0,15-0,25	0,15-0,45	0,25-0,75	0,25-1,05	0,45-1,35	30 (25-55)
K1	LNEG1005-EB1570	0,20-0,50	0,15-0,45	0,25-0,75	0,25-1,05	0,45-1,35	100 (60-200)
K2	LNEG1005-EB1570	0,20-0,50	0,15-0,45	0,25-0,75	0,25-1,05	0,45-1,35	50 (35-80)
K3	LNEG1005-EB1570	0,20-0,50	0,15-0,45	0,25-0,75	0,25-1,05	0,45-1,35	100 (60-200)
K4	LNEG1005-EB1570	0,20-0,50	0,15-0,45	0,25-0,75	0,25-1,05	0,45-1,35	70 (50-120)
K5	LNEG1005-EB1570	0,20-0,50	0,15-0,45	0,25-0,75	0,25-1,05	0,45-1,35	70 (50-120)
K6	LNEG1005-EB1570	0,20-0,50	0,15-0,45	0,25-0,75	0,25-1,05	0,45-1,35	100 (60-200)
K7	LNEG1005-EB1570	0,20-0,50	0,15-0,45	0,25-0,75	0,25-1,05	0,45-1,35	100 (60-200)

SMG = Gruppo materiale Seco

a_p = mm

f = mm/rev

v_c = m/min

Tutti i parametri di taglio sono valori di partenza

Parametri di taglio – LNEG...-EB1570 pollici

SMG		a_p (∅)	f				v_c RX2000
			z=3	z=5	z=7	z=9	
P4	LNEG1005-EB1570	0.006-0.010	0.006-0.018	0.010-0.030	0.010-0.041	0.018-0.053	195 (130-395)
P5	LNEG1005-EB1570	0.006-0.010	0.006-0.018	0.010-0.030	0.010-0.041	0.018-0.053	195 (130-395)
P6	LNEG1005-EB1570	0.006-0.010	0.006-0.018	0.010-0.030	0.010-0.041	0.018-0.053	195 (130-395)
P7	LNEG1005-EB1570	0.006-0.010	0.006-0.018	0.010-0.030	0.010-0.041	0.018-0.053	195 (130-395)
P8	LNEG1005-EB1570	0.006-0.010	0.006-0.018	0.010-0.030	0.010-0.041	0.018-0.053	130 (100-230)
P11	LNEG1005-EB1570	0.006-0.010	0.006-0.018	0.010-0.030	0.010-0.041	0.018-0.053	130 (100-230)
P12	LNEG1005-EB1570	0.006-0.010	0.006-0.018	0.010-0.030	0.010-0.041	0.018-0.053	100 (85-185)
K1	LNEG1005-EB1570	0.008-0.020	0.006-0.018	0.010-0.030	0.010-0.041	0.018-0.053	330 (195-655)
K2	LNEG1005-EB1570	0.008-0.020	0.006-0.018	0.010-0.030	0.010-0.041	0.018-0.053	165 (115-260)
K3	LNEG1005-EB1570	0.008-0.020	0.006-0.018	0.010-0.030	0.010-0.041	0.018-0.053	330 (195-655)
K4	LNEG1005-EB1570	0.008-0.020	0.006-0.018	0.010-0.030	0.010-0.041	0.018-0.053	230 (165-395)
K5	LNEG1005-EB1570	0.008-0.020	0.006-0.018	0.010-0.030	0.010-0.041	0.018-0.053	230 (165-395)
K6	LNEG1005-EB1570	0.008-0.020	0.006-0.018	0.010-0.030	0.010-0.041	0.018-0.053	330 (195-655)
K7	LNEG1005-EB1570	0.008-0.020	0.006-0.018	0.010-0.030	0.010-0.041	0.018-0.053	330 (195-655)

SMG = Gruppo materiale Seco

a_p = inch

f = in/rev

v_c = sf/min

Tutti i parametri di taglio sono valori di partenza

Parametri di taglio – RNAX...-EB45 misure metriche

SMG		a_p (∅)	f				v_c	
			z=3	z=5	z=6	z=9	RX2000	RX1500
K1	RNAX1005-EB45	0,20-0,50	0,15-0,45	0,25-0,75	0,25-1,05	0,45-1,35	100 (60-200)	220 (150-300)
K2	RNAX1005-EB45	0,20-0,50	0,15-0,45	0,25-0,75	0,25-1,05	0,45-1,35	50 (35-80)	70 (50-120)
K3	RNAX1005-EB45	0,20-0,50	0,15-0,45	0,25-0,75	0,25-1,05	0,45-1,35	100 (60-200)	220 (150-300)
K4	RNAX1005-EB45	0,20-0,50	0,15-0,45	0,25-0,75	0,25-1,05	0,45-1,35	70 (50-120)	150 (110-200)
K5	RNAX1005-EB45	0,20-0,50	0,15-0,45	0,25-0,75	0,25-1,05	0,45-1,35	70 (50-120)	150 (110-200)
K6	RNAX1005-EB45	0,20-0,50	0,15-0,45	0,25-0,75	0,25-1,05	0,45-1,35	100 (60-200)	220 (150-300)
K7	RNAX1005-EB45	0,20-0,50	0,15-0,45	0,25-0,75	0,25-1,05	0,45-1,35	100 (60-200)	220 (150-300)

SMG = Gruppo materiale Seco

a_p = mm

f = mm/rev

v_c = m/min

Tutti i parametri di taglio sono valori di partenza

Parametri di taglio – RNAX...-EB45 pollici

SMG		a_p (∅)	f				v_c	
			z=3	z=5	z=6	z=9	RX2000	RX1500
K1	RNAX1005-EB45	0.008-0.020	0.006-0.018	0.010-0.030	0.010-0.041	0.018-0.053	330 (195-655)	720 (490-985)
K2	RNAX1005-EB45	0.008-0.020	0.006-0.018	0.010-0.030	0.010-0.041	0.018-0.053	165 (115-260)	230 (165-395)
K3	RNAX1005-EB45	0.008-0.020	0.006-0.018	0.010-0.030	0.010-0.041	0.018-0.053	330 (195-655)	720 (490-985)
K4	RNAX1005-EB45	0.008-0.020	0.006-0.018	0.010-0.030	0.010-0.041	0.018-0.053	230 (165-395)	490 (360-655)
K5	RNAX1005-EB45	0.008-0.020	0.006-0.018	0.010-0.030	0.010-0.041	0.018-0.053	230 (165-395)	490 (360-655)
K6	RNAX1005-EB45	0.008-0.020	0.006-0.018	0.010-0.030	0.010-0.041	0.018-0.053	330 (195-655)	720 (490-985)
K7	RNAX1005-EB45	0.008-0.020	0.006-0.018	0.010-0.030	0.010-0.041	0.018-0.053	330 (195-655)	720 (490-985)

SMG = Gruppo materiale Seco

a_p = inch

f = in/rev

v_c = sf/min

Tutti i parametri di taglio sono valori di partenza

Parametri di taglio – RNAX...-EB845 misure metriche

SMG		a_p (°)	f				v_c	
			z=3	z=5	z=6	z=9	RX2000	RX1500
K1	RNAX1005-EB845	0,20-0,50	0,15-0,60	0,25-1	0,35-1,4	0,45-1,80	100 (60-200)	220 (150-300)
K2	RNAX1005-EB845	0,20-0,50	0,15-0,60	0,25-1	0,35-1,4	0,45-1,80	50 (35-80)	70 (50-120)
K3	RNAX1005-EB845	0,20-0,50	0,15-0,60	0,25-1	0,35-1,4	0,45-1,80	100 (60-200)	220 (150-300)
K4	RNAX1005-EB845	0,20-0,50	0,15-0,60	0,25-1	0,35-1,4	0,45-1,80	70 (50-120)	150 (110-200)
K5	RNAX1005-EB845	0,20-0,50	0,15-0,60	0,25-1	0,35-1,4	0,45-1,80	70 (50-120)	150 (110-200)
K6	RNAX1005-EB845	0,20-0,50	0,15-0,60	0,25-1	0,35-1,4	0,45-1,80	100 (60-200)	220 (150-300)
K7	RNAX1005-EB845	0,20-0,50	0,15-0,60	0,25-1	0,35-1,4	0,45-1,80	100 (60-200)	220 (150-300)

SMG = Gruppo materiale Seco

a_p = mm

f = mm/rev

v_c = m/min

Tutti i parametri di taglio sono valori di partenza

Parametri di taglio – RNAX...-EB845 pollici

SMG		a_p (°)	f				v_c	
			z=3	z=5	z=6	z=9	RX2000	RX1500
K1	RNAX1005-EB845	0.008–0.020	0.006–0.024	0.010–0.039	0.014–0.055	0.018–0.071	330 (195-655)	720 (490-985)
K2	RNAX1005-EB845	0.008–0.020	0.006–0.024	0.010–0.039	0.014–0.055	0.018–0.071	165 (115-260)	230 (165-395)
K3	RNAX1005-EB845	0.008–0.020	0.006–0.024	0.010–0.039	0.014–0.055	0.018–0.071	330 (195-655)	720 (490-985)
K4	RNAX1005-EB845	0.008–0.020	0.006–0.024	0.010–0.039	0.014–0.055	0.018–0.071	230 (165-395)	490 (360-655)
K5	RNAX1005-EB845	0.008–0.020	0.006–0.024	0.010–0.039	0.014–0.055	0.018–0.071	230 (165-395)	490 (360-655)
K6	RNAX1005-EB845	0.008–0.020	0.006–0.024	0.010–0.039	0.014–0.055	0.018–0.071	330 (195-655)	720 (490-985)
K7	RNAX1005-EB845	0.008–0.020	0.006–0.024	0.010–0.039	0.014–0.055	0.018–0.071	330 (195-655)	720 (490-985)

SMG = Gruppo materiale Seco

a_p = inch

f = in/rev

v_c = sf/min

Tutti i parametri di taglio sono valori di partenza

Introduzione

Foratura

Alesatura

Barenatura

Allegato

Parametri di taglio – RNAX...-EB1570 misure metriche

SMG		a_p (∅)	f				v_c	
			z=3	z=5	z=6	z=9	RX2000	RX1500
K1	RNAX1005-EB1570	0,20-0,50	0,15-0,45	0,25-0,75	0,25-1,05	0,45-1,35	100 (60-200)	220 (150-300)
K2	RNAX1005-EB1570	0,20-0,50	0,15-0,45	0,25-0,75	0,25-1,05	0,45-1,35	50 (35-80)	70 (50-120)
K3	RNAX1005-EB1570	0,20-0,50	0,15-0,45	0,25-0,75	0,25-1,05	0,45-1,35	100 (60-200)	220 (150-300)
K4	RNAX1005-EB1570	0,20-0,50	0,15-0,45	0,25-0,75	0,25-1,05	0,45-1,35	70 (50-120)	150 (110-200)
K5	RNAX1005-EB1570	0,20-0,50	0,15-0,45	0,25-0,75	0,25-1,05	0,45-1,35	70 (50-120)	150 (110-200)
K6	RNAX1005-EB1570	0,20-0,50	0,15-0,45	0,25-0,75	0,25-1,05	0,45-1,35	100 (60-200)	220 (150-300)
K7	RNAX1005-EB1570	0,20-0,50	0,15-0,45	0,25-0,75	0,25-1,05	0,45-1,35	100 (60-200)	220 (150-300)

SMG = Gruppo materiale Seco

a_p = mm

f = mm/rev

v_c = m/min

Tutti i parametri di taglio sono valori di partenza

Parametri di taglio – RNAX...-EB1570 pollici

SMG		a_p (∅)	f				v_c	
			z=3	z=5	z=6	z=9	RX2000	RX1500
K1	RNAX1005-EB1570	0.008-0.020	0.006-0.018	0.010-0.030	0.010-0.041	0.018-0.053	330 (195-655)	720 (490-985)
K2	RNAX1005-EB1570	0.008-0.020	0.006-0.018	0.010-0.030	0.010-0.041	0.018-0.053	165 (115-260)	230 (165-395)
K3	RNAX1005-EB1570	0.008-0.020	0.006-0.018	0.010-0.030	0.010-0.041	0.018-0.053	330 (195-655)	720 (490-985)
K4	RNAX1005-EB1570	0.008-0.020	0.006-0.018	0.010-0.030	0.010-0.041	0.018-0.053	230 (165-395)	490 (360-655)
K5	RNAX1005-EB1570	0.008-0.020	0.006-0.018	0.010-0.030	0.010-0.041	0.018-0.053	230 (165-395)	490 (360-655)
K6	RNAX1005-EB1570	0.008-0.020	0.006-0.018	0.010-0.030	0.010-0.041	0.018-0.053	330 (195-655)	720 (490-985)
K7	RNAX1005-EB1570	0.008-0.020	0.006-0.018	0.010-0.030	0.010-0.041	0.018-0.053	330 (195-655)	720 (490-985)

SMG = Gruppo materiale Seco

a_p = inch

f = in/rev

v_c = sf/min

Tutti i parametri di taglio sono valori di partenza

Istruzioni per la regolazione

Introduzione

1.

- Allentare la vite di bloccaggio cartuccia.
- Ruotare o sostituire l'inserto.
- Allentare di 1/4 di giro la vite di regolazione e spingere indietro la cartuccia.
- Serrare delicatamente di nuovo la vite di serraggio della cartuccia a circa 0,5 Nm (4.4 in/lb).

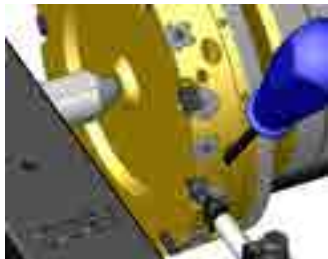

Vite di bloccaggio cartuccia
Vite di regolazione



Foratura

2.

- Azzerare il micrometro sul pattino di riferimento.
- Accertarsi che il punto di misurazione sia dopo lo smusso dell'imbocco.



Pattino di guida pre-caricato
Pattino di riferimento per la regolazione

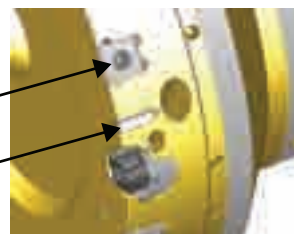

"0"

Alesatura

3.

- Utilizzando la vite di regolazione, registrare l'inserto di 0,025 mm (0,001") maggiorato rispetto al pattino di riferimento.
- Ripetere la regolazione per tutti gli inserti.



Vite di regolazione

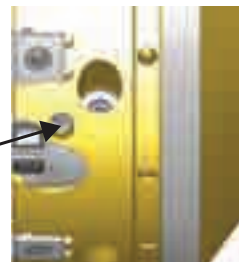

+ 0,025 mm (+ 0,001") sopra il pattino di riferimento

Barenatura

4.



- Serrare la vite di bloccaggio della cartuccia a 2 Nm (17,7 in/lb).

Vite di bloccaggio cartuccia

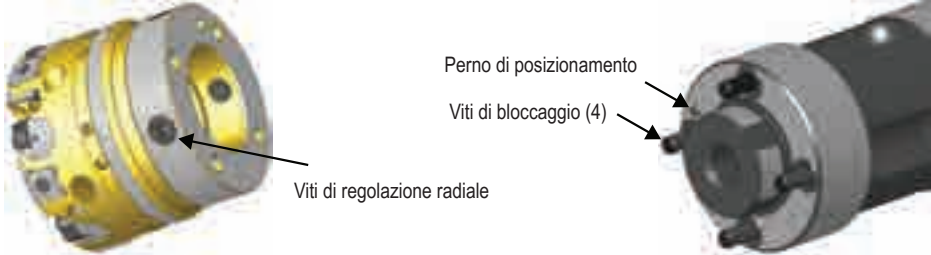
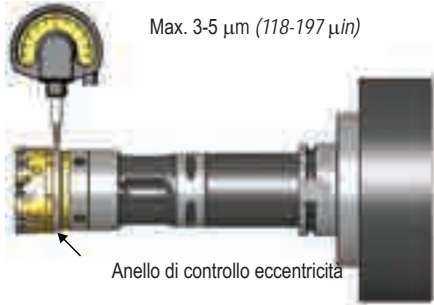

Nota: se durante la regolazione la quota prescritta viene superata, l'intera operazione deve essere ripetuta dall'inizio per annullare il gioco tra lama e viti di regolazione, che devono sempre lavorare in spinta.

Istruzioni di regolazione, adattatore

<p>1.</p> <p>Assemblaggio</p> <ul style="list-style-type: none"> • Pulire accuratamente la superficie di contatto della flangia. • Allentare le 4 viti di regolazione radiale in modo che non interferiscano durante l'assemblaggio. • Montare la testina dell'alesatore sull'adattatore (perno di posizionamento) e serrare le 4 viti di fissaggio. 	<p>Assemblaggio (figura 1)</p> 	Introduzione																														
<p>2.</p> <p>Impostazione</p> <ul style="list-style-type: none"> • Montare l'utensile sul mandrino macchina. • Montare il micrometro come mostrato nel disegno 2. • Sbloccare il mandrino macchina in modo che l'utensile ruoti liberamente. • Iniziare la correzione radiale mediante le 4 viti di regolazione (disegno 3). • Eccentricità massima 5 μm (197 μin). • Quando il valore dell'eccentricità risulta inferiore a 10 μm (394 μin), procedere col serraggio finale (disegno 1); vedere la tabella per i valori consigliati della coppia di serraggio. 	<p>Operazione di registrazione in macchina (disegno 2)</p>  <p>Viti di bloccaggio (disegno 3)</p> 	Foratura Alesatura																														
<p>3.</p> <ul style="list-style-type: none"> • Finalizzare la regolazione dell'eccentricità, max 5 μm (max 197 μin). 	<p>Viti di regolazione radiale (disegno 4)</p>  <p style="text-align: center;">Tabella coppia di serraggio</p> <table border="1" data-bbox="547 1843 1490 2085"> <thead> <tr> <th>Diametro mm</th> <th>Diametro pollici</th> <th>Dimensione adattatore</th> <th>Vite di bloccaggio</th> <th>Coppia di serraggio Nm</th> <th>Coppia di serraggio pollici/lb</th> </tr> </thead> <tbody> <tr> <td>39,5-59,499</td> <td>1,555-2,342</td> <td>HF32</td> <td>CHC M3 x 16</td> <td>2,7</td> <td>24</td> </tr> <tr> <td>59,5-84,499</td> <td>2,342-3,372</td> <td>HF55</td> <td>CHC M5 x 25</td> <td>5,7</td> <td>50</td> </tr> <tr> <td>84,5-119,499</td> <td>3,372-4,705</td> <td>HF80</td> <td>CHC M6 x 25</td> <td>9,8</td> <td>87</td> </tr> <tr> <td>119,5-154,499</td> <td>4,705-6,083</td> <td>HF100</td> <td>CHC M8 x 30</td> <td>24</td> <td>212</td> </tr> </tbody> </table>	Diametro mm	Diametro pollici	Dimensione adattatore	Vite di bloccaggio	Coppia di serraggio Nm	Coppia di serraggio pollici/lb	39,5-59,499	1,555-2,342	HF32	CHC M3 x 16	2,7	24	59,5-84,499	2,342-3,372	HF55	CHC M5 x 25	5,7	50	84,5-119,499	3,372-4,705	HF80	CHC M6 x 25	9,8	87	119,5-154,499	4,705-6,083	HF100	CHC M8 x 30	24	212	Barenatura Allegato
Diametro mm	Diametro pollici	Dimensione adattatore	Vite di bloccaggio	Coppia di serraggio Nm	Coppia di serraggio pollici/lb																											
39,5-59,499	1,555-2,342	HF32	CHC M3 x 16	2,7	24																											
59,5-84,499	2,342-3,372	HF55	CHC M5 x 25	5,7	50																											
84,5-119,499	3,372-4,705	HF80	CHC M6 x 25	9,8	87																											
119,5-154,499	4,705-6,083	HF100	CHC M8 x 30	24	212																											

Dispositivo di regolazione – Ad indicatore singolo

Introduzione

SF-210340-C160: codice prodotto 02885391

- Posizione orizzontale
- Prima scelta per alesatori Xfix
- 1 indicatore
- Ø massimo utensile: 210 mm (8,268")
- Lunghezza massima utensile: 340 mm (13,386")
- Inclusa nella fornitura: contropunta ad azione elastica addizionale Ø 57 mm (2,244") per HSK 63/80/100 e Capto C8 SSC5700 Codice prodotto 02208620



Foratura

SF-210290V-C160: codice prodotto 02885392

- Posizione verticale
- Prima scelta per alesatori Xfi
- Ø massimo utensile: 210 mm (8,268")
- Lunghezza massima utensile: 290 mm (11,417")
- Inclusa nella fornitura: contropunta ad azione elastica addizionale Ø 57 mm (2,244") per HSK 63/80/100 e Capto C8 SSC5700 Codice prodotto 02208620



Alesatura

Dispositivo di regolazione – Ad indicatore multiplo

Barenatura

Possibilità di dispositivi multi-indicatore, vedere il capitolo relativo ai dispositivi di regolazione alle pagine 510-515 per maggiori dettagli



Allegato

Gamma attacchi disponibili



Diametro mm	Diametro pollici	Max rapporto diam./lunghezza
39,5-59,499	1,555-2,342	6,5 x D
59,5-84,499	2,342-3,372	4,5 x D
84,5-119,499	3,372-4,705	3,3 x D
119,5-154,499	4,705-6,083	2,5 x D

Nota: Per diametri > 100 mm (3,937") o per L > 3 x D, verificare il peso massimo accettabile dalla macchina.

Applicazioni rotanti

Introduzione

Foratura

Alesatura

Barenatura

Allegato

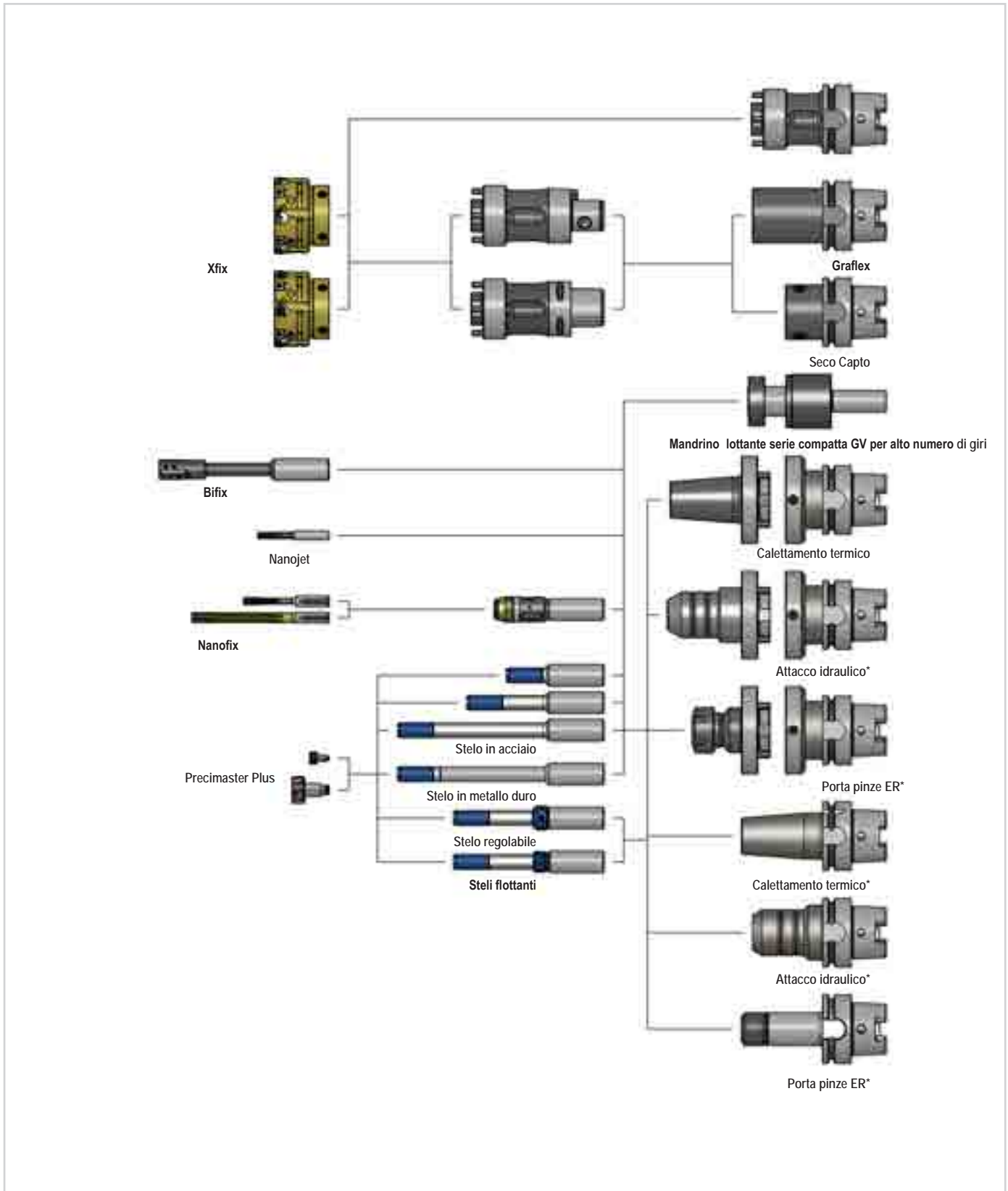

*Vedere catalogo SISTEMI DI UTENSILI

Le migliori prestazioni sono ottenute con montaggio rigido (attacco idraulico, porta pinze ER a calettamento termico)

Applicazioni non rotanti

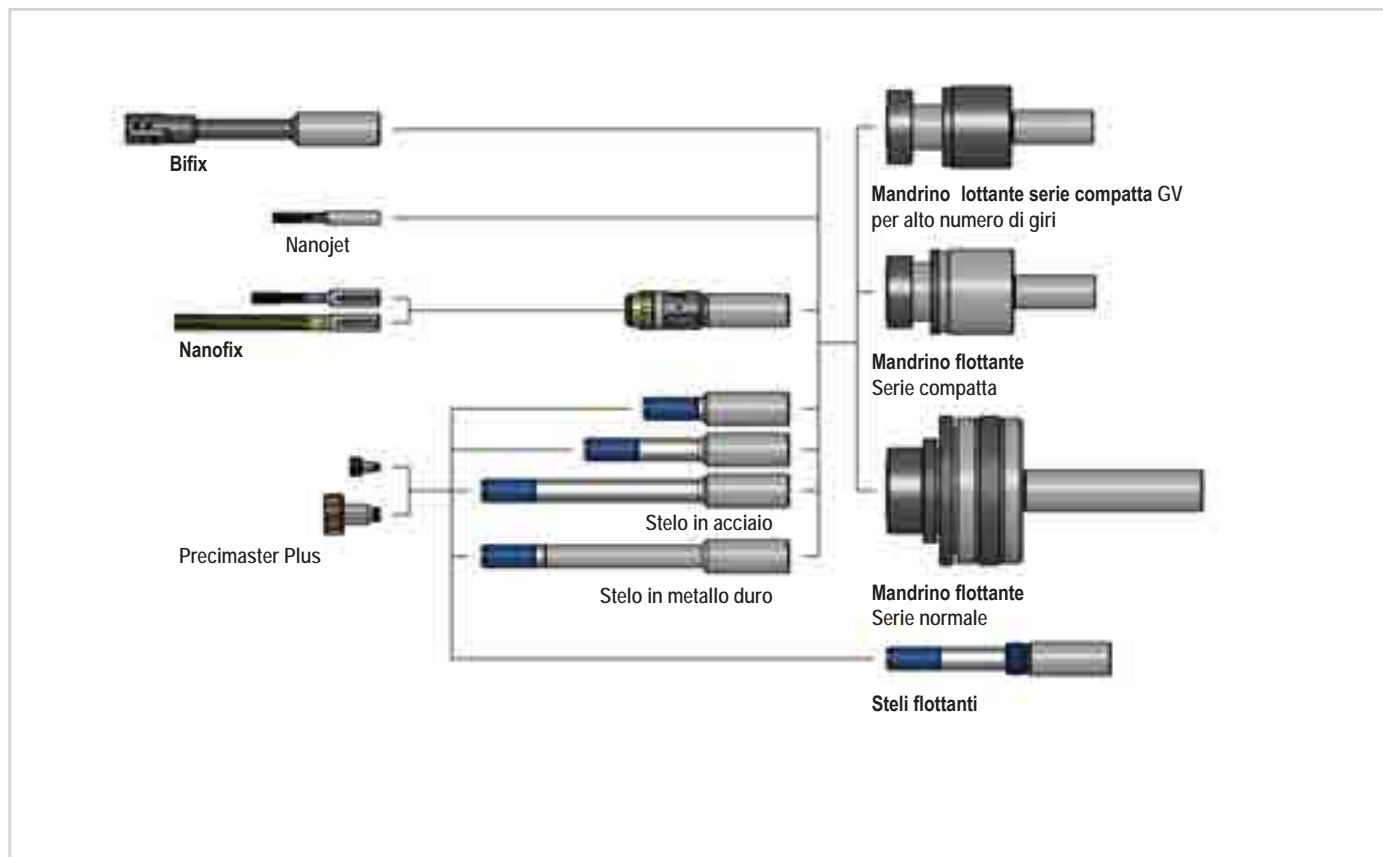

Dimensione flangia

Introduzione

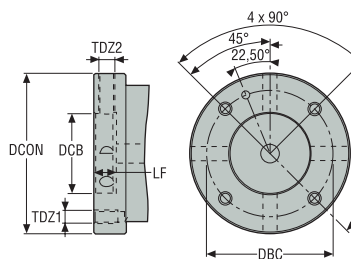

Foratura

DCON	DCB +/- 0,1	DCB F8	LF	TDZ1	TDZ2
60	44	30	12	M5	M8x1
70	53	35	12	M6	M8x1
80	63	40	12	M6	M8x1
100	79	50	14	M8	M10x1
117	96	60	14	M8	M10x1
140	119	80	14	M10	M10x1

Alesatura

Barenatura

Allegato

Lato Macchina HSK-A

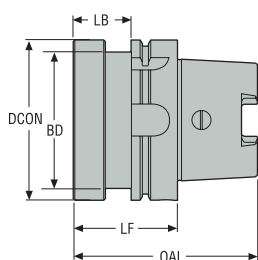

• Nota: Tubo del refrigerante e viti inclusi nella fornitura

Codice di ordinazione	Codice prodotto	Cono	DCON	BD	LB	LF	OAL	Peso
			mm Inch	mm Inch	mm Inch	mm Inch	mm Inch	kg lb
SAH-23405100001	02836663	HSK-A 100	60,0 2.362	60,0 2.362	26,0 1.024	55,0 2.165	105,0 4.134	2,5 5.510
SAH-23405100002	02836665	HSK-A 100	80,0 3.150	80,0 3.150	26,0 1.024	55,0 2.165	105,0 4.134	2,9 6.390
SAH-23405100003	02836666	HSK-A 100	100,0 3.937	85,0 3.346	36,0 1.417	65,0 2.559	115,0 4.528	3,5 7.720
SAH-23405100007	02836664	HSK-A 100	70,0 2.756	70,0 2.756	26,0 1.024	55,0 2.165	105,0 4.134	2,8 6.170
SAH-23405500001	02836566	HSK-A 50	60,0 2.362	42,0 1.654	34,0 1.339	60,0 2.362	85,0 3.346	0,95 2.090
SAH-23405630001	02836574	HSK-A 63	60,0 2.362	53,0 2.087	34,0 1.339	60,0 2.362	92,0 3.622	1,2 2.650
SAH-23405630002	02836576	HSK-A 63	80,0 3.150	53,0 2.087	34,0 1.339	60,0 2.362	92,0 3.622	1,4 3.090
SAH-23405630003	02836575	HSK-A 63	70,0 2.756	53,0 2.087	34,0 1.339	60,0 2.362	92,0 3.622	1,3 2.870
SAH-23405630004	02836577	HSK-A 63	100,0 3.937	53,0 2.087	39,0 1.535	65,0 2.559	97,0 3.819	1,95 4.300
SAH-23405800001	02836655	HSK-A 80	60,0 2.362	60,0 2.362	24,0 0.945	50,0 1.969	90,0 3.543	1,4 3.090
SAH-23405800002	02836658	HSK-A 80	80,0 3.150	67,0 2.638	34,0 1.339	60,0 2.362	100,0 3.937	1,6 3.530
SAH-23405800003	02836657	HSK-A 80	70,0 2.756	67,0 2.638	34,0 1.339	60,0 2.362	100,0 3.937	1,5 3.310
SAH-23405800004	02836660	HSK-A 80	100,0 3.937	67,0 2.638	39,0 1.535	65,0 2.559	105,0 4.134	2,2 4.850

Parti di ricambio, comprese nella fornitura

Per DCON	Vite staffa	Vite di regolazione
60	CHCM5X20/ISO4762	HCM8X12X1/ISO4028
70	CHCM6X20/ISO4762	HCM8X16X1/ISO4028
80	CHCM6X25/ISO4762	HCM8X16X1/ISO4028
100	CHCM8X25/ISO4762	HCM10X20X1/ISO4028

Lato Macchina DIN 69871

Introduzione

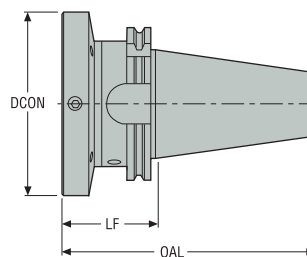



- Nota: Viti incluse nella fornitura

Foratura

Codice di ordinazione	Codice prodotto	Cono	DCON	LF	OAL	Peso
			mm Inch	mm Inch	mm Inch	kg lb
SAH-2340640201	02836683	DIN40 ADB	60,0 2.362	50,0 1.969	118,4 4.661	1,3 2.870
SAH-2340640202	02836685	DIN40 ADB	80,0 3.150	55,0 2.165	123,4 4.858	1,7 3.750
SAH-2340640203	02836686	DIN40 ADB	100,0 3.937	60,0 2.362	128,4 5.055	2,3 5.070
SAH-2340650201	02836687	DIN50 ADB	60,0 2.362	50,0 1.969	151,8 5.976	3,1 6.830
SAH-2340650202	02836690	DIN50 ADB	80,0 3.150	50,0 1.969	151,8 5.976	3,5 7.720
SAH-2340650203	02836691	DIN50 ADB	100,0 3.937	60,0 2.362	161,8 6.370	4,3 9.480

Alesatura

Parti di ricambio, comprese nella fornitura

Per DCON	Vite staffa	Vite di regolazione
60	 CHCM5X20/ISO4762	 HCM8X12X1/ISO4028
80	CHCM6X25/ISO4762	HCM8X16X1/ISO4028
100	CHCM8X25/ISO4762	HCM10X20X1/ISO4028

Barenatura

Allegato

Lato Macchina ANSI CAT

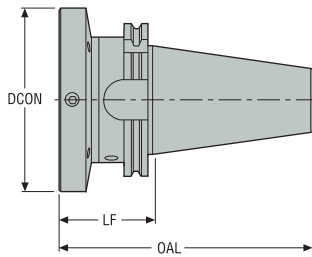

- Nota: Viti incluse nella fornitura
- Filettatura tirante in pollici

Codice di ordinazione	Codice prodotto	Cono	DCON		LF		OAL		Peso	
			mm	Inch	mm	Inch	mm	Inch	kg	lb
SAH-2784940201	02836698	CAT 40	60,0	2.362	50,0	1.969	118,4	4.661	1,1	2.430
SAH-2784940202	02836702	CAT 40	80,0	3.150	60,0	2.362	128,4	5.055	1,8	3.970
SAH-2784940203	02836704	CAT 40	100,0	3.937	60,0	2.362	128,4	5.055	2,3	5.070
SAH-2784950201	02836707	CAT 50	60,0	2.362	50,0	1.969	151,8	5.976	3,1	6.830
SAH-2784950202	02836709	CAT 50	80,0	3.150	60,0	2.362	161,8	6.370	3,4	7.500
SAH-2784950203	02836710	CAT 50	100,0	3.937	80,0	3.150	181,8	7.157	5,5	12.130

Parti di ricambio, comprese nella fornitura

Per DCON	Vite staffa	Vite di regolazione
60	CHCM5X20/ISO4762	HCM8X12X1/ISO4028
80	CHCM6X25/ISO4762	HCM8X16X1/ISO4028
100	CHCM8X25/ISO4762	HCM10X20X1/ISO4028

Introduzione

Foratura

Alesatura

Barenatura

Allegato

Lato Macchina BT

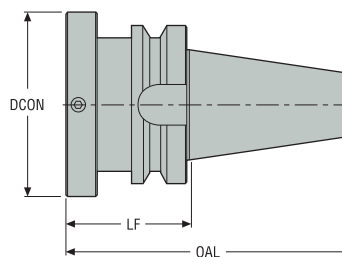

• Nota: Viti incluse nella fornitura

Codice di ordinazione	Codice prodotto	Cono	DCON		LF		OAL		Peso	
			mm	Inch	mm	Inch	mm	Inch	kg	lb
SAH-2340740001	02836717	BT40 ADB	60,0	2.362	55,0	2.165	120,4	4.740	1,4	3.090
SAH-2340740002	02836719	BT40 ADB	80,0	3.150	65,0	2.559	130,4	5.134	2,0	4.410
SAH-2340740003	02836721	BT40 ADB	100,0	3.937	60,0	2.362	125,4	4.937	2,7	5.950
SAH-2340740004	02836718	BT40 ADB	70,0	2.756	55,0	2.165	120,4	4.740	1,5	3.310
SAH-2340750001	02836724	BT50 ADB	60,0	2.362	70,0	2.756	171,8	6.764	4,2	9.260
SAH-2340750002	02836725	BT50 ADB	70,0	2.756	70,0	2.756	171,8	6.764	4,4	9.700
SAH-2340750003	02836726	BT50 ADB	80,0	3.150	70,0	2.756	171,8	6.764	4,6	10.140
SAH-2340750004	02836727	BT50 ADB	100,0	3.937	70,0	2.756	171,8	6.764	5,1	11.240

Parti di ricambio, comprese nella fornitura

Per DCON	Vite staffa	Vite di regolazione
60	CHCM5X20/ISO4762	HCM8X12X1/ISO4028
70	CHCM6X20/ISO4762	HCM8X16X1/ISO4028
80	CHCM6X25/ISO4762	HCM8X16X1/ISO4028
100	CHCM8X25/ISO4762	HCM10X20X1/ISO4028

Calettamento termico

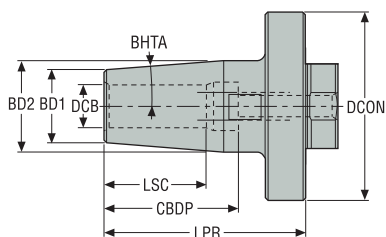

• Nota: Viti di regolazione incluse nella fornitura

Codice di ordinazione	Codice prodotto	DCON	BD2	BD1	DCB	LSC	CBDP	LPR	Peso	BHTA°
		mm Inch	mm Inch	mm Inch	mm Inch	mm Inch	mm Inch	mm Inch		
SAH-2341012238	02836737	60,0 2.362	32,0 1.260	24,0 0.945	12,0 0.472	34,0 1.339	47,5 1.870	70,0 2.756	0,52 1.150	4.5
SAH-2341016241	02836741	70,0 2.756	34,0 1.339	27,0 1.063	16,0 0.630	39,0 1.535	50,5 1.988	75,0 2.953	0,7 1.540	4.5
SAH-2341020251	02836742	80,0 3.150	42,0 1.654	33,0 1.299	20,0 0.787	41,0 1.614	52,5 2.067	80,0 3.150	1,0 2.200	4.5
SAH-2341025260	02836743	100,0 3.937	53,0 2.087	44,0 1.732	25,0 0.984	47,0 1.850	58,5 2.303	80,0 3.150	2,2 4.850	4.5
SAH-2341032261	02836744	100,0 3.937	53,0 2.087	44,0 1.732	32,0 1.260	51,0 2.008	62,5 2.461	80,0 3.150	2,5 5.510	4.5

Parti di ricambio, comprese nella fornitura

Per DCON	Vite di regolazione
60	HCM6X12/ISO4028
70	HCM6X16/ISO4028
80	HCM6X16/ISO4028
100	HCM8X12X1/ISO4028



Mandrino idraulico

Introduzione

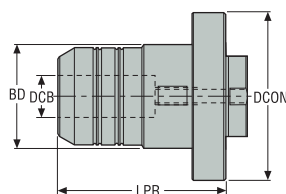

- Nota: Viti di regolazione incluse nella fornitura

Foratura

Codice di ordinazione	Codice prodotto	DCON	BD	DCB	LPR	Peso
		mm Inch	mm Inch	mm Inch	mm Inch	kg lb
SAH-2341112255	02836752	80,0 3.150	32,0 1.260	12,0 0.472	77,5 3.051	1,1 2.430
SAH-2341112259	02836757	100,0 3.937	32,0 1.260	12,0 0.472	90,0 3.543	1,9 4.190
SAH-2341116253	02836749	70,0 2.756	38,0 1.496	16,0 0.630	50,0 1.969	0,75 1.650
SAH-2341116256	02836754	80,0 3.150	38,0 1.496	16,0 0.630	82,5 3.248	1,2 2.650
SAH-2341120257	02836755	80,0 3.150	42,0 1.654	20,0 0.787	82,5 3.248	1,3 2.870
SAH-2341125258	02836756	80,0 3.150	50,0 1.969	25,0 0.984	90,0 3.543	1,7 3.750
SAH-2341125260	02836758	100,0 3.937	50,0 1.969	25,0 0.984	100,0 3.937	2,8 6.170
SAH-2341132261	02836759	100,0 3.937	60,0 2.362	32,0 1.260	103,0 4.055	2,9 6.390

Alesatura

Parti di ricambio, comprese nella fornitura

Per DCON

Vite di regolazione



70	HCM6X16/ISO4028
80	HCM6X16/ISO4028
100	HCM8X12X1/ISO4028

Barenatura

Allegato

Porta pinze ER

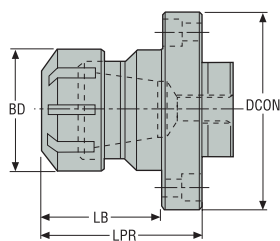

• Nota: Viti di regolazione incluse nella fornitura

Codice di ordinazione	Codice prodotto	Dimensione	DCON	BD	LB	LPR	Peso
			mm <i>Inch</i>	mm <i>Inch</i>	mm <i>Inch</i>	mm <i>Inch</i>	kg <i>lb</i>
SAH-23412ER25254	02836762	ER25	80,0 3.150	42,0 1.654	45,0 1.772	60,0 2.362	1,0 2.200
SAH-23412ER32255	02836763	ER32	80,0 3.150	50,0 1.969	45,0 1.772	60,0 2.362	1,2 2.650
SAH-23412ER40256	02836764	ER40	100,0 3.937	63,0 2.480	50,0 1.969	70,0 2.756	1,6 3.530

Parti di ricambio, comprese nella fornitura

Per DCON	Vite di regolazione
80	HCM6X16/ISO4028
100	HCM8X12X1/ISO4028



Istruzioni di assemblaggio

Introduzione

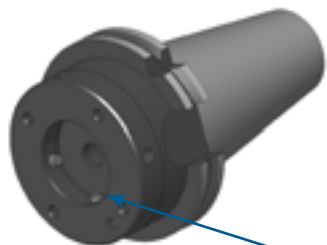

Viti di regolazione radiale

- Pulire la superficie di contatto
- Verificare che le viti di regolazione radiale non interferiscano con l'assemblato

Foratura



Viti di bloccaggio

Viti di regolazione angolare

Spina di riferimento (opzionale)

- Verificare che le viti di regolazione angolare non interferiscano con l'assemblato

Alesatura



Viti di regolazione radiale (4 viti)

Viti di regolazione angolare (4 viti)

Viti di bloccaggio (4 viti)

- Procedere all'assemblaggio e pre-serrare delicatamente le viti di bloccaggio (x4)

Barenatura

Allegato

Istruzioni per la regolazione

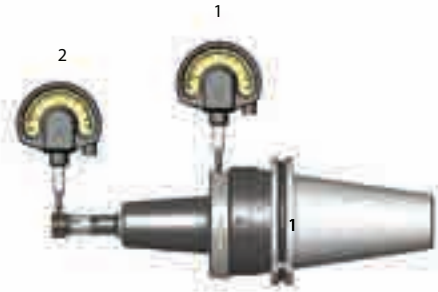
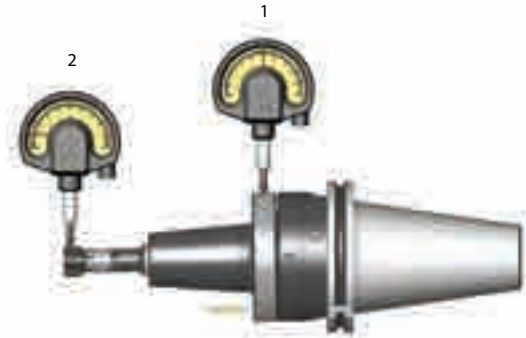
<ul style="list-style-type: none"> • Montare l'utensile sul mandrino macchina • Montare il micrometro 1 come mostrato (micrometro 2 non necessario per questa fase) • Ruotare l'utensile a mano fino a trovare il valore più basso indicato dal micrometro • Procedere alla compensazione dell'eccentricità radiale come mostrato dalla freccia • Controllare e ripetere la compensazione se necessario 		Introduzione
<ul style="list-style-type: none"> • Montare il micrometro 2 come mostrato • Ruotare l'utensile a mano fino a trovare il valore più basso indicato dal micrometro • Procedere alla compensazione dell'eccentricità radiale come mostrato dalla freccia • Controllare e ripetere la compensazione se necessario 		Foratura
<ul style="list-style-type: none"> • Una volta terminata la regolazione, eccentricità $<5 \mu\text{m}$ ($197 \mu\text{in}$), finalizzare il bloccaggio dell'assemblato • L'adattatore regolabile può essere preimpostato a bordo macchina utilizzando un qualsiasi dispositivo di preimpostazione disponibile in officina • La regolazione finale deve sempre essere fatta in nel mandrino macchina • Dev'essere utilizzato un comparatore micrometrico. È accettabile usare un solo comparatore per entrambe le operazioni. 		Alesatura
		Barenatura
		Allegato

Panoramica della gamma

L'uso di mandrini flottanti Seco è consigliato

- Quando l'eccentricità è superiore a 0,02 mm (0,0008")
- Per utensili non rotanti

Serie compatta GV per alto numero di giri

- Prima scelta per utensili rotanti
- Regolazione non richiesta (effettuata dal produttore)
- Numero di giri fino a 3000 giri/min in funzione dell'applicazione
- Adatti anche per applicazioni statiche



Serie compatta

- Prima scelta per utensili non rotanti
- Solo con regolazione radiale
- Adatti anche per applicazioni rotanti – max. 800 giri/min



Serie normale

- Quando è richiesta una correzione sia radiale che angolare
- Adatti anche per applicazioni rotanti – max. 800 giri/min



Tutti i mandrini flottanti sono dotati di fori per adduzione refrigerante.
Disponibili 2 tipi di adduzione:

JJL: foro filettato sul fianco
JJ: attraverso l'attacco

Manuale di istruzioni compreso nella fornitura.

Serie compatta GV per alto numero di giri

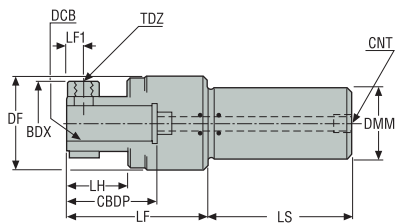

Codice di ordinazione	Codice prodotto	DCB	DMM	LF	LS	DF	BDX	LH	CBDP	CNT	LF1	TDZ	ADJRG	Peso
		mm	mm	mm	mm	mm	mm	mm	mm	mm	mm	mm	mm	kg
SFH-GV11019JJ	00088959	10,0	19,05	47,5	40,0	33,0	30,0	11,5	25,0	1/8	5,5	M6	0,2	0,7
SFH-GV11020JJ	00088945	10,0	20,0	47,5	40,0	33,0	30,0	11,5	25,0	1/8	5,5	M6	0,2	0,8
SFH-GV21619JJ	00076815	16,0	19,05	66,0	50,0	49,5	39,0	24,5	40,0	1/8	8,0	M8	0,2	0,8
SFH-GV21620JJ	00072133	16,0	20,0	66,0	50,0	49,5	39,0	24,5	40,0	1/8	8,0	M8	0,2	0,8
SFH-GV22019JJ	00076827	20,0	19,05	76,0	50,0	49,5	45,0	34,5	50,0	1/8	8,0	M8	0,2	0,8
SFH-GV22020JJ	00072134	20,0	20,0	76,0	50,0	49,5	45,0	34,5	50,0	1/8	8,0	M8	0,2	0,8
SFH-GV32525JJ	00076828	25,0	25,4	89,0	60,0	62,0	52,0	43,5	60,0	1/4	11,0	M10	0,3	1,4
SFH-GV32525MJJ	00072135	25,0	25,0	89,0	60,0	62,0	52,0	43,5	60,0	1/4	11,0	M10	0,3	1,4
SFH-GV325425JJ	00088960	25,4	25,4	89,0	60,0	62,0	52,0	43,5	60,0	1/4	11,0	M10	0,3	1,4
SFH-GV43232JJ	02602671	32,0	32,0	90,0	80,0	72,0	60,0	34,0	60,0	3/8	9,0	M10	0,3	2,2

Accessori

Codice di ordinazione

Anello di riduzione

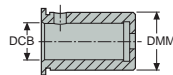

	DCB	DMM
SRR-BR11016	10	16
SRR-BR11216	12	16
SRR-BR11220	12	20
SRR-BR21620	16	20
SRR-BR31625	16	25
SRR-BR32025	20	25
SRR-GV42532	25	32

Introduzione

Foratura

Alesatura

Barenatura

Allegato

Serie compatta GV per alto numero di giri con porta pinze

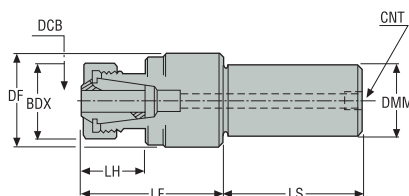

Codice di ordinazione	Codice prodotto	CZC	DMM	LF	LS	DF	BDX	LH	CNT	ADJRG	Peso
			mm	mm	mm	mm	mm	mm		mm	kg
SFH-GV3BC25MJJ	00088946	ER32	25,0	80,0	60,0	62,0	50,0	35,0	1/4	0,3	1,3
SFH-GV3BC25JJ	00088961	ER32	25,4	80,0	60,0	62,0	50,0	35,0	1/4	0,3	1,3
SFH-GV4BC31JJ	00088962	ER40	31,75	94,0	80,0	72,0	63,0	39,0	3/8	0,3	0,7
SFH-GV4BC32JJ	00088947	ER40	32,0	94,0	80,0	72,0	63,0	39,0	3/8	0,3	2,4

Accessori

Codice di ordinazione	Dimensione	Pinza*	Dimensione	Chiave*		
		DCB	BD	OAL		
58803210	ER32	10	33	40	ER32	03B587532
58803212	ER32	12	33	40	-	-
58803213	ER32	13	33	40	-	-
58803216	ER32	16	33	40	-	-
58803220	ER32	20	33	40	-	-
58804016	ER40	16	41	46	ER40	03B537540
58804020	ER40	20	41	46	-	-
58804025	ER40	25	41	46	-	-
58804026	ER40	26	41	46	-	-

*Pinze e le chiavi non vengono fornite con i mandrini.

Serie compatta

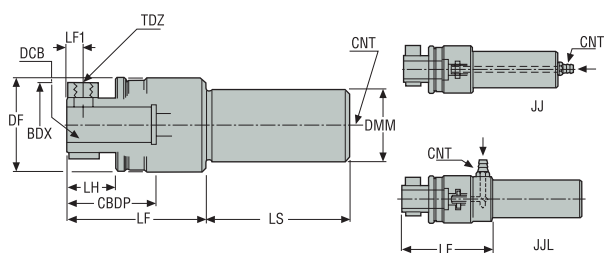

Codice di ordinazione	Codice prodotto	DCB	DMM	LF	LS	DF	BDx	LH	CBDP	CNT	LF1	TDZ	ADJRG	Peso
		mm	mm	mm	mm	mm	mm	mm	mm		mm		mm	kg
SFH-C01019JJ	00088963	10,0	19,05	44,5	40,0	38,5	30,0	11,0	25,0	1/8	6,0	M6	1,0	0,575
SFH-C21619CJJ	00076829	16,0	19,05	67,5	50,0	51,5	34,0	17,0	40,0	1/4	8,0	M6	1,5	0,97
SFH-C22019JL	00088966	20,0	19,05	97,0	70,0	51,5	44,0	27,0	50,0	1/4	8,0	M8	1,5	1,1
SFH-C22019CJJ	00076830	20,0	19,05	77,5	50,0	51,5	44,0	27,0	50,0	1/4	8,0	M8	1,5	0,97
SFH-C01020JJ	00088948	10,0	20,0	44,5	40,0	38,5	30,0	11,0	25,0	1/8	6,0	M6	1,0	0,59
SFH-C21620CJJ	00072142	16,0	20,0	67,5	50,0	51,5	34,0	17,0	40,0	1/4	8,0	M6	1,5	0,97
SFH-C22020CJJ	00072145	20,0	20,0	77,5	50,0	51,5	44,0	27,0	50,0	1/4	8,0	M8	1,5	1,0
SFH-C22020JL	00088951	20,0	20,0	97,0	60,0	51,5	44,0	27,0	50,0	1/4	8,0	M8	1,5	1,1
SFH-C32525JJ	00076846	25,0	25,4	90,0	110,0	59,5	50,0	31,0	60,0	3/8	11,0	M8	1,5	1,7
SFH-C32525JL	00088967	25,0	25,4	125,0	70,0	59,5	50,0	31,0	60,0	3/8	11,0	M8	1,5	1,98
SFH-C32525MJ	00072149	25,0	25,0	90,0	110,0	59,5	50,0	31,0	60,0	3/8	11,0	M8	1,5	1,6

Accessori

Codice di ordinazione	Anello di riduzione	
	DCB	DMM
SRR-BR11016	10	16
SRR-BR11216	12	16
SRR-BR11220	12	20
SRR-BR21620	16	20
SRR-BR31625	16	25
SRR-BR32025	20	25

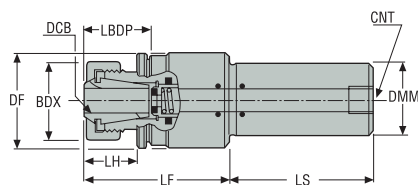

L'adattatore non è incluso nella fornitura.

Serie compatta con porta pinze

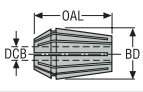

Codice di ordinazione	Codice prodotto	CZC	DMM	LF	LS	DF	BDX	CBDP	LH	CNT	ADJRG	Peso
			mm	mm	mm	mm	mm	mm	mm		mm	kg
SFH-C65BC25MCJJ	00088953	ER32	25,0	94,0	50,0	64,5	50,0	42,0	33,0	3/8	1,5	1,7
SFH-C65BC25CJJ	00088968	ER32	25,4	94,0	50,0	64,5	50,0	42,0	33,0	3/8	1,5	1,7

Accessori

Codice di ordinazione	Dimensione	Pinza*	Dimensione	Chiave*		
						
		DCB	BD	OAL		
58803210	ER32	10	33	40	ER32	03B587532
58803212	ER32	12	33	40	-	-
58803213	ER32	13	33	40	-	-
58803216	ER32	16	33	40	-	-
58803220	ER32	20	33	40	-	-
58804016	ER40	16	41	46	ER40	03B537540
58804020	ER40	20	41	46	-	-
58804025	ER40	25	41	46	-	-
58804026	ER40	26	41	46	-	-

*Pinze e chiavi non vengono fornite con i mandrini.

Serie normale

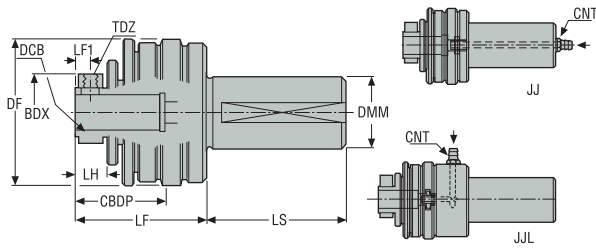

Codice di ordinazione	Codice prodotto	DCB	DMM	LF	LS	DF	BDX	LH	CBDP	CNT	LF1	TDZ	ADJRG	ANADJ	Peso
		mm	mm	mm	mm	mm	mm	mm	mm		mm	mm	mm	°	kg
SFH-11619JJ	00088969	16,0	19,05	64,0	50,0	62,0	34,0	16,0	40,0	1/4	8,0	M6	1,5	1,0°	0,9
SFH-11619JL	00088970	16,0	19,05	81,0	40,0	62,0	34,0	16,0	40,0	1/4	8,0	M6	1,5	1,0°	1,32
SFH-11620JJ	00088954	16,0	20,0	64,0	50,0	62,0	34,0	16,0	40,0	1/4	8,0	M6	1,5	1,0°	0,95
SFH-11620JL	00088955	16,0	20,0	81,0	40,0	62,0	34,0	16,0	40,0	1/4	8,0	M6	1,5	1,0°	1,34
SFH-22025JJ	00088971	20,0	25,4	74,0	65,0	82,0	44,0	16,0	50,0	3/8	8,0	M8	1,5	1,0°	1,9
SFH-22025JL	00088972	20,0	25,4	98,0	70,0	82,0	44,0	16,0	50,0	1/4	8,0	M8	1,5	1,0°	2,2
SFH-22025MJJ	00088956	20,0	25,0	74,0	65,0	82,0	44,0	16,0	50,0	3/8	8,0	M8	1,5	1,0°	1,9
SFH-32525JJ	00088973	25,0	25,4	82,5	110,0	91,0	52,0	22,0	60,0	3/8	11,0	M8	2,0	1,0°	2,5
SFH-32525MJJ	00088958	25,0	25,0	82,5	110,0	91,0	52,0	22,0	60,0	3/8	11,0	M8	2,0	1,0°	2,5

Accessori

Codice di ordinazione

Anello di riduzione

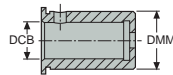

	DCB	DMM
SRR-BR11016	10	16
SRR-BR11216	12	16
SRR-BR11220	12	20
SRR-BR21620	16	20
SRR-BR31625	16	25
SRR-BR32025	20	25

L'adattatore non è incluso nella fornitura.

Introduzione

Foratura

Alesatura

Barenatura

Allegato

Dispositivo di regolazione – Ad indicatore singolo

Introduzione

SF-210340-C160: codice prodotto 02885391

- Posizione orizzontale
- Prima scelta per alesatori Xfix
- 1 indicatore
- Ø massimo utensile: 210 mm (8,268")
- Lunghezza massima utensile: 340 mm (13,386")
- Inclusa nella fornitura: contropunta ad azione elastica addizionale Ø 57 mm (2,224") per HSK 63/80/100 e Capto C8 SSC5700 Codice prodotto 02208620



Foratura

SF-210290V-C160: codice prodotto 02885392

- Posizione verticale
- Prima scelta per alesatori Xfi
- Ø massimo utensile: 210 mm (8,268")
- Lunghezza massima utensile: 290 mm (11,417")
- Inclusa nella fornitura: contropunta ad azione elastica addizionale Ø 57 mm (2,224") per HSK 63/80/100 e Capto C8 SSC5700 Codice prodotto 02208620



Alesatura

Dispositivo di regolazione – Ad indicatore doppio

Barenatura

SF-210340-C160C190: codice prodotto 02885393

- Posizione orizzontale
- Prima scelta per alesatori Bifix
- 2 indicatori
- Ø massimo utensile: 210 mm (8,268")
- Lunghezza massima utensile: 340 mm (13,386")
- Inclusa nella fornitura: contropunta ad azione elastica addizionale Ø 57 mm (2,224") per HSK 63/80/100 e Capto C8 SSC5700 Codice prodotto 02208620



Allegato



SF-210290V-C160C190: codice prodotto 02885394

- Posizione verticale
- Prima scelta per alesatori Bifix
- 2 indicatori
- Ø massimo utensile: 210 mm (8,268")
- Lunghezza massima utensile: 290 mm (11,417")
- Inclusa nella fornitura: contropunta ad azione elastica addizionale Ø 57 mm (2,224") per HSK 63/80/100 e Capto C8 SSC5700 Codice prodotto 02208620





Per informazioni sugli ordini, rivolgersi al rappresentante Seco Tools di zona.

Dispositivo di regolazione – Indicatore singolo grande capacità

<p>SF-210740-C160: codice prodotto 02885385</p> <ul style="list-style-type: none"> • Posizione orizzontale • Prima scelta per alesatori Xfix • 1 indicatore • Ø massimo utensile: 210 mm (8,268") • Lunghezza massima utensile: 740 mm (29,134") • Inclusa nella fornitura: contropunta ad azione elastica addizionale Ø 57 mm (2,224") per HSK 63/80/100 e Capto C8 SSC5700 Codice prodotto 02208620 	
<p>SF-210690V-C160: codice prodotto 02885387</p> <ul style="list-style-type: none"> • Posizione verticale • Prima scelta per alesatori Xfi • Ø massimo utensile: 210 mm (8,268") • Lunghezza massima utensile: 690 mm (27,165") • Inclusa nella fornitura: contropunta ad azione elastica addizionale Ø 57 mm (2,224") per HSK 63/80/100 e Capto C8 SSC5700 Codice prodotto 02208620 	

Apparecchio di regolazione – Grande capacità del doppio orologio

<p>SF-210740-C160C190: codice prodotto 02885388</p> <ul style="list-style-type: none"> • Posizione orizzontale • Prima scelta per alesatori Bifix • 2 indicatori • Ø massimo utensile: 210 mm (8,268") • Lunghezza massima utensile: 740 mm (29,134") • Inclusa nella fornitura: contropunta ad azione elastica addizionale Ø 57 mm (2,224") per HSK 63/80/100 e Capto C8 SSC5700 Codice prodotto 02208620 	
<p>SF-210690V-C160C190: codice prodotto 02885390</p> <ul style="list-style-type: none"> • Posizione verticale • Prima scelta per alesatori Bifix • 2 indicatori • Ø massimo utensile: 210 mm (8,268") • Lunghezza massima utensile: 690 mm (27,165") • Inclusa nella fornitura: contropunta ad azione elastica addizionale Ø 57 mm (2,224") per HSK 63/80/100 e Capto C8 SSC5700 Codice prodotto 02208620 	

Per informazioni sugli ordini, rivolgersi al rappresentante Seco Tools di zona.

Dispositivo di regolazione – Compatto

Introduzione

SF-60200-C160: codice prodotto 02885395

- Posizione orizzontale
- Prima scelta per \varnothing minori di 60 mm (2,362")
- 1 indicatore
- \varnothing massimo utensile: 60,5 mm (2,382")
- Lunghezza massima utensile: 200 mm (7,874")



Foratura

SF-60200-C160C190: codice prodotto 02885396

- Posizione orizzontale
- Prima scelta per \varnothing minori di 60 mm (2,362")
- 2 indicatori
- \varnothing massimo utensile: 60,5 mm (2,382")
- Lunghezza massima utensile: 200 mm (7,874")



Alesatura

Per informazioni sugli ordini, rivolgersi al rappresentante Seco Tools di zona.

Barenatura

Allegato

Braccetti di misura aggiuntivi

	<p>SFB-60: codice prodotto 02208619</p> <ul style="list-style-type: none"> • Braccetto di misura a 60° • Comparatore compreso nella fornitura • Punto di misurazione non incluso, vedere pagina 514
	<p>SFB-60 WC: codice prodotto 02885754</p> <ul style="list-style-type: none"> • Braccetto di misura a 60° • Comparatore non compreso nella fornitura • Punto di misurazione non incluso, vedere pagina 514
	<p>SFB-90: codice prodotto 02208622</p> <ul style="list-style-type: none"> • Braccetto di misura a 90° • Comparatore compreso nella fornitura • Punto di misurazione non incluso, vedere pagina 514
	<p>SFB-90 WC: codice prodotto 02885755</p> <ul style="list-style-type: none"> • Braccetto di misura a 90° • Comparatore non compreso nella fornitura • Punto di misurazione non incluso, vedere pagina 514
	<p>DG-1: codice prodotto 75079579</p> <ul style="list-style-type: none"> • Comparatore, 1 μm (39 μin)



Esempi di dispositivi multi indicatore assemblati



Accessori

Introduzione		<p>SMES-406: codice prodotto 02819156</p> <ul style="list-style-type: none"> • Punto di misurazione per alesatori Xfix • Ø 4 mm (0,157") • Riporto in metallo duro
Foratura		<p>SMES-900: codice prodotto 02208610</p> <ul style="list-style-type: none"> • Punto di misurazione per alesatori Bifix • Riporto in metallo duro
Alesatura		<p>SMES-909: codice prodotto 02980090</p> <ul style="list-style-type: none"> • Punto di misurazione per alesatori Bifix • Riporto in metallo duro • 9 mm (0,354") di spazio
Barenatura		<p>SFHS-20: codice prodotto 02884025</p> <ul style="list-style-type: none"> • Vite manuale • Adatta a tutti i dispositivi di regolazione
Allegato		<p>SFVST-100: codice prodotto 02884026</p> <ul style="list-style-type: none"> • Supporto in acciaio (set di 3) • Ø 100 mm (3,937") • Adatto per utilizzare il dispositivo di regolazione orizzontale in posizione verticale

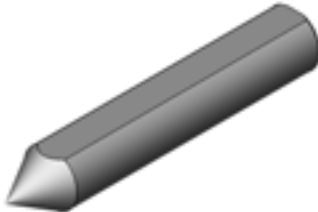
Contropunte

<p>SFC-2000HM: codice prodotto 02884023</p> <ul style="list-style-type: none"> • Contropunta fissa in metallo duro integrale • Ø 20 mm (0,787") • Adatta per alesatori Xfix e Bifix standard e speciali • Da utilizzarsi con nella parte anteriore dell'utensile 		<p>Introduzione</p> <p>Foratura</p>
<p>SSC-3400: codice prodotto 02208617</p> <ul style="list-style-type: none"> • Contropunta precaricata • Tronco-conica Ø 34 mm (1,339") • Adatta per alesatori Xfix e Bifix standard e speciali • Da utilizzarsi con nella parte anteriore posteriore dell'utensile • Adatta per HSK63/80/100 e Capto C8 		
<p>SSC5700: codice prodotto 02208620</p> <ul style="list-style-type: none"> • Contropunta precaricata • Tronco-conica Ø 57 mm (2,244") • Adatta per alesatori Xfix e Bifix standard e speciali • Da utilizzarsi nella parte anteriore posteriore dell'utensile • Adatta a HSK63/80/100 e Capto C8 		<p>Barenatura</p> <p>Allegato</p>

Panoramica

Graflex® e Seco-Capto™

Gli attacchi, le prolunghe e i riduttori Graflex® e Seco-Capto™ consentono di costruire barre di barenatura



Pagine 518-577, 578

- Gli assemblati di barre di barenatura possono essere realizzati rapidamente per soddisfare le esigenze più vicine, utilizzando i sistemi modulari Graflex o Seco-Capto che includono un'ampia gamma di attacchi e parti intermedie.
- Entrambi i sistemi offrono una connessione rigida e precisa da utilizzare per le applicazioni di sgrossatura o finitura dei fori.
- I moduli possono anche ricevere un gran numero di portautensili come porta pinza, mandrini idraulici, ecc. (vedere il catalogo Tooling Systems (Sistemi di utensili)).

Testine per barenatura RB750, barenatura di sgrossatura

Bitaglienti, con meccanismo di accoppiamento dei portainseriti



Pagine 589, 590-596

- Elevato volume di truciolo asportato, geometria e posizione del foro precise
- Per applicazioni sia simmetriche che a gradino
- Regolazione simultanea mediante meccanismo di accoppiamento portainseriti
- Con connessioni Graflex® o Seco-Capto™

Gamma Ø da 18 a 205 mm
(da 0,709 a 8,071")

IT 9/10

Testine per barenatura RB 610, barenatura di sgrossatura

Bitaglienti



Pagine 602-605

- Elevato volume di truciolo asportato, geometria e posizione del foro precise
- Per applicazioni sia simmetriche che a gradino
- Con connessione Graflex® per il sistema modulare Graflex®
- Con connessione GL o BA per le barre Steadylite™ con smorzamento delle vibrazioni

Gamma Ø da 28 mm a 116 mm
(da 1,102 a 4,567")

IT 9/10

Testine per barenatura FB 760, tipo Axiabore™, barenatura di finitura

Testine per barenatura di finitura, con utensili assiali



Pagine 614-629

- Regolazione micrometrica per fori di precisione fino a IT5
- Elevata rigidità utensile per una precisa geometria del foro
- Testina Nanobore™ per i diametri piccoli
- Le testine Axialibrabore™ e Axialibrabore™ Plus sono equilibrabili di precisione ed adatte per HSM (alta velocità)
- Adattatore multiuso (MPA) per grandi diametri di barenatura, tornitura esterna e scanalatura
- Con connessioni Graflex® o Seco-Capto™

Gamma Ø da 0,3 a 108 mm
(da 0,012 a 4,252")

+ Tornitura esterna e scanalatura frontale

IT 5/6

Panoramica

Testine per barenatura FB 620, FB 780 e FB 790, tipo radiale

Testine per barenatura di finitura, con portainsero radiale



Pagine 648, 649-657

- Regolazione micrometrica per fori di precisione fino a IT5
- Geometria e posizionamento del foro precisi
- Le testine A790 Libraflex® sono equilibrabili di precisione, portainseri con serraggio adatto ad HSM (operazioni ad alta velocità) per la massima affidabilità
- Fori lunghi fino a 7xD utilizzando prolunghe in metallo duro, oppure fino a 10xD utilizzando barre Steadyline®
- Anche per smussatura e per barenatura in tirata
- Con connessioni Graflex® o Seco-Capto™ per i sistemi modulari
- Con connessione GL o BA per le barre Steadyline® con smorzamento delle vibrazioni

Gamma Ø da 15 a 205 mm
(da 0,591 a 8,071")

IT 5/6

Introduzione

Ponti e testine per barenatura Jumbo

Per barenatura di sgrossatura e di finitura di diametri grandi



Pagine 659-676

- Unità mobili per barenatura di sgrossatura e di finitura, per tornitura esterna e per barenatura in tirata
- Sistema robusto per barenatura di sgrossatura, per elevati volumi di materiale asportato
- Regolazione micrometrica per barenatura di finitura
- Unità per barenatura ottimizzate e ponti di barenatura Jumbo realizzati in alluminio ad alta resistenza
- Da montare su attacchi per frese a manicotto, con montaggio su flangia

Gamma Ø da 204 a 3205 mm
(da 8,031 a 126,181")

IT 5/6 (barenatura di finitura) o
9/10 (barenatura di sgrossatura)
+ Tornitura esterna

IT6

Foratura

Inseri per operazioni di barenatura



Pagine 678-690

- Per applicazioni di barenatura su tutti i materiali
- Elevata tenacità per barenatura di sgrossatura
- Geometrie positive per barenatura di finitura
- Le qualità selezionate garantiscono una lunga durata

Alesatura

Sistemi modulari Graflex® o Seco-Capto™



Pagine 691-693

- Le testine per barenatura hanno connessione Graflex® o Seco-Capto™ lato macchina, il che consente la scelta di una vasta gamma di profondità e diametri di barenatura
- Scegliere gli attacchi base e le parti intermedie Graflex® o Seco-Capto™ consultando il catalogo SISTEMI DI UTENSILI (HSK, DIN, BT, ANSI-CAT, Seco-Capto™)
- Le parti di ricambio per le testine con connessione Graflex® sono mostrate nel capitolo specifico

Barenatura

Allegato



Graflex®

Gli assemblati Graflex® comprendono attacchi base, parti intermedie, portautensile e testine per barenatura e possono essere facilmente costruiti in funzione dell'applicazione. Adatti a fresatura, foratura, maschiatura, alesatura e barenatura, i moduli Graflex® offrono lunghezze e diametri variabili e possono essere montati su tutte le tipologie di macchine semplicemente sostituendo l'attacco base Graflex®.

- La connessione garantisce eccellente rigidità
- L'ampia gamma di moduli offre un'elevata flessibilità
- Possibilità di adduzione refrigerante interna

Graflex®, Dimensioni secondo normativa

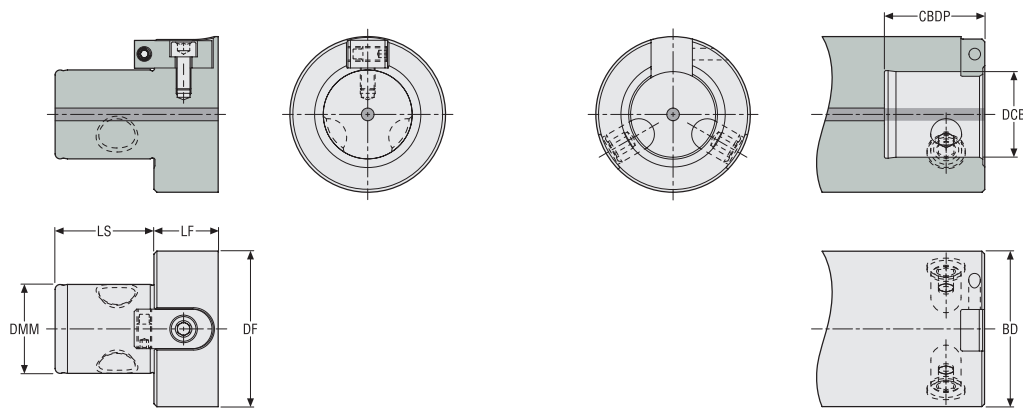

Tipologia lato macchina	Sede per microchip*	DF	DMM	LS	LF
		mm Inch	mm Inch	mm Inch	mm Inch
G0	No	16 0.630	8 0.315	12 0.472	8 0.315
G1	No	20 0.787	11 0.433	13 0.512	9,5 0.374
G2	No	25 0.984	14 0.551	16 0.630	11 0.433
G3	No	32 1.260	18 0.709	20 0.787	14 0.551
G4	No	40 1.575	22 0.866	24 0.945	17 0.669
G5	No	50 1.969	28 1.102	30 1.181	20 0.787
G6	No	63 2.480	36 1.417	40 1.575	26 1.024
G7	No	90 3.543	46 1.811	50 1.969	26 1.024

Lato lato macchina	Sede per microchip*	CBDP	DCB	BD
		mm Inch	mm Inch	mm Inch
G0	No	16 0.630	8 0.315	12 0.472
G1	No	20 0.787	11 0.433	13 0.512
G2	No	25 0.984	14 0.551	16 0.630
G3	No	32 1.260	18 0.709	20 0.787
G4	No	40 1.575	22 0.866	24 0.945
G5	No	50 1.969	28 1.102	30 1.181
G6	No	63 2.480	36 1.417	40 1.575
G7	No	90 3.543	46 1.811	50 1.969

Nota: Queste norme dimensionali lato macchina e lato utensile sono applicate a tutti gli attacchi mostrati nelle pagine di prodotto.

* Senza sede per microchip RFID

G 401 – Adattatori Graflex®

HSK-A/ ISO12164-1-HSK-A

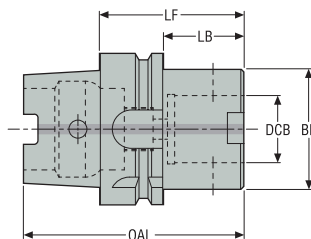

- Per i grani di tenuta, i tubi del refrigerante e le chiavi HSK, vedere pag. 547

Codice di ordinazione	Codice prodotto	CTMS	CTWS	DCB	LF	LB	BD	OAL	Sede RFID	Equilibratura	Peso
				mm Inch	mm Inch	mm Inch	mm Inch	mm Inch			
EM93034012870	00086917	HSK-A50	G5	28,0 1.102	70,0 2.756	44,0 1.732	50,0 1.969	95,0 3.740	1	PB	0,9 1.980
EM93044011445	02469722	HSK-A63	G2	14,0 0.551	45,0 1.772	19,0 0.748	25,0 0.984	77,0 3.031	1	G6.3	0,69 1.520
EM93044011850	00086918	HSK-A63	G3	18,0 0.709	50,0 1.969	24,0 0.945	32,0 1.260	82,0 3.228	1	G6.3	0,73 1.610
EM93044012255	00088217	HSK-A63	G4	22,0 0.866	55,0 2.165	29,0 1.142	40,0 1.575	87,0 3.425	1	G6.3	0,9 1.980
EM93044012860	00086920	HSK-A63	G5	28,0 1.102	60,0 2.362	34,0 1.339	50,0 1.969	92,0 3.622	1	PB	1,0 2.200
EM930440128100	00086921	HSK-A63	G5	28,0 1.102	100,0 3.937	74,0 2.913	50,0 1.969	132,0 5.197	1	PB	1,6 3.530
EM930440128140	00086922	HSK-A63	G5	28,0 1.102	140,0 5.512	114,0 4.488	50,0 1.969	172,0 6.772	1	PB	2,18 4.810
EM93044013670	00086923	HSK-A63	G6	36,0 1.417	70,0 2.756	44,0 1.732	63,0 2.480	102,0 4.016	1	PB	1,3 2.870
EM930440136120	00086924	HSK-A63	G6	36,0 1.417	120,0 4.724	94,0 3.701	63,0 2.480	152,0 5.984	1	PB	2,38 5.250
EM93064011855	00086925	HSK-A100	G3	18,0 0.709	55,0 2.165	26,0 1.024	32,0 1.260	105,0 4.134	1	G6.3	2,2 4.850
EM93064012260	00086926	HSK-A100	G4	22,0 0.866	60,0 2.362	31,0 1.220	40,0 1.575	110,0 4.331	1	G6.3	2,3 5.070
EM93064012865	00086927	HSK-A100	G5	28,0 1.102	65,0 2.559	36,0 1.417	50,0 1.969	115,0 4.528	1	PB	2,37 5.220
EM930640128110	00086928	HSK-A100	G5	28,0 1.102	110,0 4.331	81,0 3.189	50,0 1.969	160,0 6.299	1	PB	3,1 6.830
EM930640128150	00086929	HSK-A100	G5	28,0 1.102	150,0 5.906	121,0 4.764	50,0 1.969	200,0 7.874	1	PB	3,7 8.160
EM93064013675	00083432	HSK-A100	G6	36,0 1.417	75,0 2.953	46,0 1.811	63,0 2.480	125,0 4.921	1	PB	2,8 6.170
EM930640136120	00086931	HSK-A100	G6	36,0 1.417	120,0 4.724	91,0 3.583	63,0 2.480	170,0 6.693	1	PB	3,9 8.600
EM930640136160	00086932	HSK-A100	G6	36,0 1.417	160,0 6.299	131,0 5.157	63,0 2.480	210,0 8.268	1	PB	4,8 10.580
EM93064014685	00074385	HSK-A100	G7	46,0 1.811	85,0 3.346	56,0 2.205	90,0 3.543	135,0 5.315	1	PB	4,0 8.820
EM930640146160	00086933	HSK-A100	G7	46,0 1.811	160,0 6.299	131,0 5.157	90,0 3.543	210,0 8.268	1	PB	7,67 16.910
HSKA125-G6-120	03229653	HSK-A125	G6	36,0 1.417	120,0 4.724	91,0 3.583	63,0 2.480	183,0 7.205	1	PB	5,1 11.240
HSKA125-G7-120	03229654	HSK-A125	G7	46,0 1.811	120,0 4.724	91,0 3.583	90,0 3.543	183,0 7.205	1	PB	7,1 15.650

Introduzione

Foratura

Alésatura

Barenatura

Allegato

Parti di ricambio, comprese nella fornitura

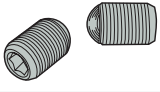
Per dimensione	Vite di assemblaggio
	
G2	90F2
G3	90F3
G4	90F4
G5	90F5
G6	90F6
G7	90F7

Accessori

Per dimensione	Chiave di bloccaggio
	
G2	03H025
G3	03H03
G4	03H04
G5	03H05
G6	03H06
G7	03H10

G 401 – Adattatori Graflex®

SA/SK/DIN 69871-ADB

Introduzione



Disegno 1

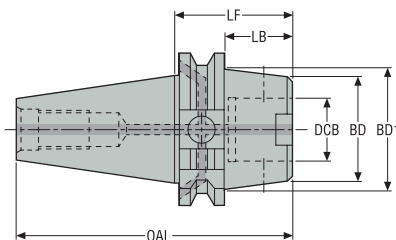

Disegno 2

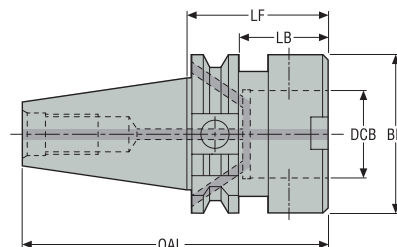

Foratura

Codice di ordinazione	Codice prodotto	CTMS	CTWS	DCB	LF	LB	BD1	OAL	Disegno	Sede RFID	Equilibratura	Peso
				mm Inch	mm Inch	mm Inch	mm Inch	mm Inch				
EM34694011190	02503292	DIN40 ADB	G1	11,0 0.433	90,0 3.543	70,9 2.791	-	158,4 6.236	2	1	G6.3	1,0 2.200
EM34694011435	02469729	DIN40 ADB	G2	14,0 0.551	35,0 1.378	15,9 0.626	-	103,4 4.071	2	1	G6.3	0,83 1.830
EM34694011490	02503293	DIN40 ADB	G2	14,0 0.551	90,0 3.543	70,9 2.791	-	158,4 6.236	2	1	G6.3	1,1 2.430
EM34694011835	02420097	DIN40 ADB	G3	18,0 0.709	35,0 1.378	15,9 0.626	50,0 1.969	103,4 4.071	1	1	G6.3	1,0 2.200
EM346940118100	02503298	DIN40 ADB	G3	18,0 0.709	100,0 3.937	80,9 3.185	-	168,4 6.630	2	1	G6.3	1,22 2.690
EM34694012235	02503299	DIN40 ADB	G4	22,0 0.866	35,0 1.378	15,9 0.626	50,0 1.969	103,4 4.071	1	1	G6.3	0,92 2.030
EM346940122100	02503300	DIN40 ADB	G4	22,0 0.866	100,0 3.937	80,9 3.185	-	168,4 6.630	2	1	G6.3	1,5 3.310
EM34694012840	02458421	DIN40 ADB	G5	28,0 1.102	40,0 1.575	20,9 0.823	-	108,4 4.268	2	1	PB	1,0 2.200
EM34694012880	02503301	DIN40 ADB	G5	28,0 1.102	80,0 3.150	60,9 2.398	-	148,4 5.843	2	1	PB	1,5 3.310
EM346940128120	02503302	DIN40 ADB	G5	28,0 1.102	120,0 4.724	100,9 3.972	-	188,4 7.417	2	1	PB	2,1 4.630
EM34694013660	02503303	DIN40 ADB	G6	36,0 1.417	60,0 2.362	40,9 1.610	-	128,4 5.055	2	1	PB	1,3 2.870
EM346940136120	02503304	DIN40 ADB	G6	36,0 1.417	120,0 4.724	100,9 3.972	-	188,4 7.417	2	1	PB	2,7 5.950
EM347140114100	02503306	DIN50 ADB	G2	14,0 0.551	100,0 3.937	80,9 3.185	-	201,7 7.941	2	1	G6.3	2,9 6.390
EM34714011835	02503307	DIN50 ADB	G3	18,0 0.709	35,0 1.378	15,9 0.626	-	136,7 5.382	2	1	G6.3	2,67 5.890
EM347140118110	02503308	DIN50 ADB	G3	18,0 0.709	110,0 4.331	90,9 3.579	-	211,7 8.335	2	1	G6.3	3,1 6.830
EM34714012235	02503309	DIN50 ADB	G4	22,0 0.866	35,0 1.378	15,9 0.626	80,0 3.150	136,7 5.382	1	1	G6.3	2,88 6.350
EM347140122120	02503311	DIN50 ADB	G4	22,0 0.866	120,0 4.724	100,9 3.972	-	221,7 8.728	2	1	G6.3	3,4 7.500
EM34714012840	02503312	DIN50 ADB	G5	28,0 1.102	40,0 1.575	20,9 0.823	-	141,7 5.579	2	1	PB	2,75 6.060
EM347140128100	02503315	DIN50 ADB	G5	28,0 1.102	100,0 3.937	80,9 3.185	-	201,7 7.941	2	1	PB	3,56 7.850
EM347140128140	02503316	DIN50 ADB	G5	28,0 1.102	140,0 5.512	120,9 4.760	-	241,7 9.516	2	1	PB	4,08 8.990
EM34714013645	02503317	DIN50 ADB	G6	36,0 1.417	45,0 1.772	25,9 1.020	-	146,7 5.776	2	1	PB	2,9 6.390
EM347140136100	02503318	DIN50 ADB	G6	36,0 1.417	100,0 3.937	80,9 3.185	-	201,7 7.941	2	1	PB	4,1 9.040
EM347140136140	02503319	DIN50 ADB	G6	36,0 1.417	140,0 5.512	120,9 4.760	-	241,7 9.516	2	1	PB	5,1 11.240

Barenatura



Allegato

Codice di ordinazione	Codice prodotto	CTMS	CTWS	DCB	LF	LB	BD1	OAL	Disegno	Sede RFID	Equilibratura	Peso
				mm Inch	mm Inch	mm Inch	mm Inch	mm Inch				kg lb
EM34714014650	02503320	DIN50 ADB	G7	46,0 1.811	50,0 1.969	30,9 1.217	-	151,7 5.972	2	1	PB	3,3 7.280
EM347140146120	02503321	DIN50 ADB	G7	46,0 1.811	120,0 4.724	100,9 3.972	-	221,7 8.728	2	1	PB	6,5 14.330
EM347140146200	02503324	DIN50 ADB	G7	46,0 1.811	200,0 7.874	180,9 7.122	-	301,7 11.878	2	1	PB	10,4 22.930

Accessori

Per dimensione	Chiave di bloccaggio
	
DIN40/ G1	03H02
DIN40/ G2	03H025
DIN40/ G3	03H03
DIN40/ G4	03H04
DIN40/ G5	03H05
DIN40/ G6	03H06
DIN50/ G2	03H025
DIN50/ G3	03H03
DIN50/ G4	03H04
DIN50/ G5	03H05
DIN50/ G6	03H06
EM34714014650	03H10
DIN50/ G7	03H10

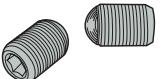
Parti di ricambio, comprese nella fornitura

Per dimensione	Vite di assemblaggio	Sealing Screws
		
DIN40/ G1	90F1	950A0406
DIN40/ G2	90F2	950A0406
DIN40/ G3	90F3	950A0406
DIN40/ G4	90F4	950A0406
DIN40/ G5	90F5	950A0406
DIN40/ G6	90F6	950A0406
DIN50/ G2	90F2	950A0606
DIN50/ G3	90F3	950A0606
DIN50/ G4	90F4	950A0606
DIN50/ G5	90F5	950A0606
DIN50/ G6	90F6	950A0606
DIN50/ G7	90F7	950A0606
EM34714014650	90F71	950A0606

Introduzione

Foratura

Alesatura

Barenatura

Allegato

G 401 – Adattatori Graflex®

DIN 2080



Disegno 1

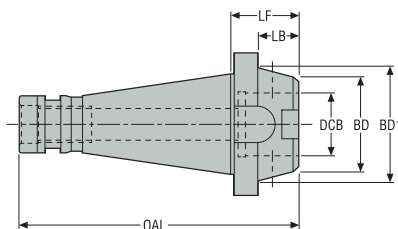

Disegno 2

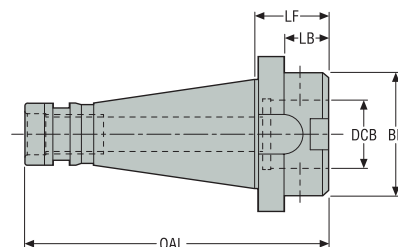

Codice di ordinazione	Codice prodotto	CTMS	CTWS	DCB	LF	LB	BD1	BD	OAL	Disegno	Sede RFID	Equilibratura	Peso
				mm Inch	mm Inch	mm Inch	mm Inch	mm Inch	mm Inch				kg lb
EM00404013650	00076707	DIN(2080)40	G6	36,0 1.417	50,0 1.969	0,0 -	-	63,0 2.480	143,4 5.646	2	0	PB	1,3 2.870
EM00504012835	00076710	DIN(2080)50	G5	28,0 1.102	35,0 1.378	19,8 0.780	78,0 3.071	50,0 1.969	161,8 6.370	1	0	PB	2,94 6.480
EM00504013640	00076714	DIN(2080)50	G6	36,0 1.417	40,0 1.575	24,8 0.976	-	63,0 2.480	166,8 6.567	2	0	PB	2,9 6.390
EM00504014645	00076718	DIN(2080)50	G7	46,0 1.811	45,0 1.772	29,8 1.173	-	90,0 3.543	171,8 6.764	2	0	PB	3,34 7.360

Accessori

Per dimensione	Chiave di bloccaggio
G6	03H06
G5	03H05
G7	03H10



Parti di ricambio, comprese nella fornitura

Per dimensione	Vite di assemblaggio
G5	90F5
G6	90F6
G7	90F7

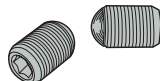

Introduzione

Foratura

Alesatura

Barenatura

Allegato

G 401 – Adattatori Graflex®

BT JIS B 6339-AD

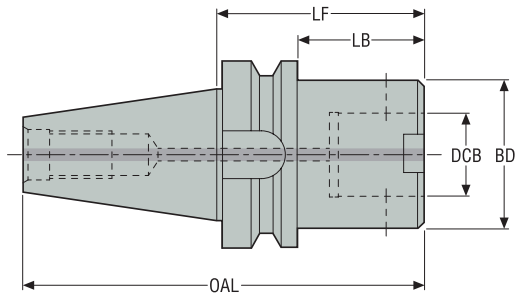

Codice di ordinazione	Codice prodotto	CTMS	CTWS	DCB	LF	LB	BD	OAL	Sede RFID	Equilibra- tura	Peso
				mm Inch	mm Inch	mm Inch	mm Inch	mm Inch			kg lb
EM40404011835	00056699	BT30 AD	G3	18,0 0.709	35,0 1.378	13,0 0.512	32,0 1.260	83,4 3.283	0	G6.3	0,5 1.100
EM40404012850	00056705	BT30 AD	G5	28,0 1.102	50,0 1.969	25,0 0.984	50,0 1.969	98,4 3.874	0	PB	0,7 1.540

Accessori

Per dimensione

Chiave di bloccaggio



EM40404011835

03H03

EM40404012850

03H05

Parti di ricambio, comprese nella fornitura

Per dimensione

Vite di assemblaggio

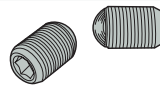

EM40404011835

90F3

EM40404012850

90F5

Introduzione

Foratura

Alesatura

Barenatura

Allegato

G 401 – Adattatori Graflex®

BT JIS B 6339-ADB

Introduzione

Foratura

Alesatura

Barenatura

Allegato



Disegno 1

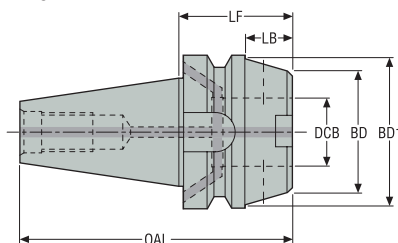

Disegno 2

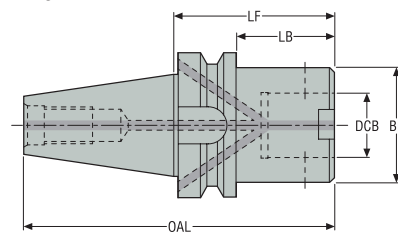



Codice di ordinazione	Codice prodotto	CTMS	CTWS	DCB	LF	LB	BD1	BD	OAL	Disegno	Sede RFID	Equilibratura	Peso
				mm Inch	mm Inch	mm Inch	mm Inch	mm Inch	mm Inch				kg lb
EM34144011190	02503364	BT40 ADB	G1	11,0 0.433	90,0 3.543	63,0 2.480	–	20,0 0.787	155,4 6.118	2	1	G6.3	1,1 2.430
EM34144011440	02469725	BT40 ADB	G2	14,0 0.551	40,0 1.575	13,0 0.512	–	25,0 0.984	105,4 4.150	2	1	G6.3	0,98 2.160
EM34144011490	02503365	BT40 ADB	G2	14,0 0.551	90,0 3.543	63,0 2.480	–	25,0 0.984	155,4 6.118	2	1	G6.3	1,2 2.650
EM34144011840	02503366	BT40 ADB	G3	18,0 0.709	40,0 1.575	13,0 0.512	62,0 2.441	32,0 1.260	105,4 4.150	1	1	G6.3	1,07 2.360
EM341440118100	02503367	BT40 ADB	G3	18,0 0.709	100,0 3.937	73,0 2.874	–	32,0 1.260	165,4 6.512	2	1	G6.3	1,31 2.890
EM34144012245	02503368	BT40 ADB	G4	22,0 0.866	45,0 1.772	18,0 0.709	62,0 2.441	40,0 1.575	110,4 4.346	1	1	G6.3	1,2 2.650
EM341440122100	02503370	BT40 ADB	G4	22,0 0.866	100,0 3.937	73,0 2.874	–	40,0 1.575	165,4 6.512	2	1	G6.3	1,6 3.530
EM34144012845	02457989	BT40 ADB	G5	28,0 1.102	45,0 1.772	18,0 0.709	62,0 2.441	50,0 1.969	110,4 4.346	1	1	PB	1,2 2.650
EM34144012880	02503371	BT40 ADB	G5	28,0 1.102	80,0 3.150	53,0 2.087	–	50,0 1.969	145,4 5.724	2	1	PB	1,6 3.530
EM341440128120	02503372	BT40 ADB	G5	28,0 1.102	120,0 4.724	93,0 3.661	–	50,0 1.969	185,4 7.299	2	1	PB	2,2 4.850
EM34144013650	02503373	BT40 ADB	G6	36,0 1.417	50,0 1.969	0,0 –	–	63,0 2.480	115,4 4.543	2	0	PB	1,2 2.650
EM341440136120	02503374	BT40 ADB	G6	36,0 1.417	120,0 4.724	0,0 –	–	63,0 2.480	185,4 7.299	2	1	PB	2,8 6.170
EM341640114110	02503375	BT50 ADB	G2	14,0 0.551	110,0 4.331	72,0 2.835	–	25,0 0.984	211,8 8.339	2	1	G6.3	3,8 8.380
EM34164011845	02503376	BT50 ADB	G3	18,0 0.709	45,0 1.772	7,0 0.276	70,0 2.756	32,0 1.260	146,8 5.780	1	1	G6.3	3,6 7.940
EM341640118120	02503377	BT50 ADB	G3	18,0 0.709	120,0 4.724	82,0 3.228	–	32,0 1.260	221,8 8.732	2	1	G6.3	4,0 8.820
EM34164012250	02503378	BT50 ADB	G4	22,0 0.866	50,0 1.969	12,0 0.472	70,0 2.756	40,0 1.575	151,8 5.976	1	1	G6.3	3,7 8.160
EM341640122140	02503379	BT50 ADB	G4	22,0 0.866	140,0 5.512	102,0 4.016	–	40,0 1.575	241,8 9.520	2	1	G6.3	4,4 9.700
EM34164012855	02503380	BT50 ADB	G5	28,0 1.102	55,0 2.165	17,0 0.669	98,0 3.858	50,0 1.969	156,8 6.173	1	1	PB	4,0 8.820
EM341640128100	02503381	BT50 ADB	G5	28,0 1.102	100,0 3.937	62,0 2.441	–	50,0 1.969	201,8 7.945	2	1	PB	4,3 9.480
EM341640128140	02503382	BT50 ADB	G5	28,0 1.102	140,0 5.512	102,0 4.016	–	50,0 1.969	241,8 9.520	2	1	PB	4,9 10.800
EM34164013663	02503383	BT50 ADB	G6	36,0 1.417	63,0 2.480	25,0 0.984	98,0 3.858	63,0 2.480	164,8 6.488	1	1	PB	4,3 9.480
EM341640136100	02503384	BT50 ADB	G6	36,0 1.417	100,0 3.937	62,0 2.441	–	63,0 2.480	201,8 7.945	2	1	PB	4,7 10.360
EM341640136140	02503385	BT50 ADB	G6	36,0 1.417	140,0 5.512	102,0 4.016	–	63,0 2.480	241,8 9.520	2	1	PB	5,6 12.350

Codice di ordinazione	Codice prodotto	CTMS	CTWS	DCB	LF	LB	BD1	BD	OAL	Disegno	Sede RFID	Equilibratura	Peso
				mm Inch	mm Inch	mm Inch	mm Inch	mm Inch	mm Inch				kg lb
EM34164014665	02503386	BT50 ADB	G7	46,0 1.811	65,0 2.559	27,0 1.063	98,0 3.858	90,0 3.543	166,8 6.567	1	1	PB	4,4 9.700
EM341640146120	02503387	BT50 ADB	G7	46,0 1.811	120,0 4.724	82,0 3.228	-	90,0 3.543	221,8 8.732	2	1	PB	6,9 15.210
EM341640146200	02503388	BT50 ADB	G7	46,0 1.811	200,0 7.874	162,0 6.378	-	90,0 3.543	301,8 11.882	2	1	PB	10,7 23.590

Accessori

Per dimensione	Chiave di bloccaggio
	
BT40/ G1	03H02
BT40/ G2	03H025
BT40/ G3	03H03
BT40/ G4	03H04
BT40/ G5	03H05
BT40/ G6	03H06
BT50/ G2	03H025
BT50/ G3	03H03
BT50/ G4	03H04
BT50/ G5	03H05
BT50/ G6	03H06
BT50/ G7	03H10

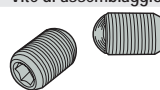
Parti di ricambio, comprese nella fornitura

Per dimensione	Vite di assemblaggio	Sealing Screws
		
BT40/ G1	90F1	950A0406
BT40/ G2	90F2	950A0406
BT40/ G3	90F3	950A0406
BT40/ G4	90F4	950A0406
BT40/ G5	90F5	950A0406
BT40/ G6	90F6	950A0406
BT50/ G2	90F2	950A0606
BT50/ G3	90F3	950A0606
BT50/ G4	90F4	950A0606
BT50/ G5	90F5	950A0606
BT50/ G6	90F6	950A0606
BT50/ G7	90F7	950A0606

Introduzione

Foratura

Alesatura

Barenatura

Allegato

G 401 – Adattatori Graflex®

BT Cono-Flangia-AD/ADB



Disegno 1

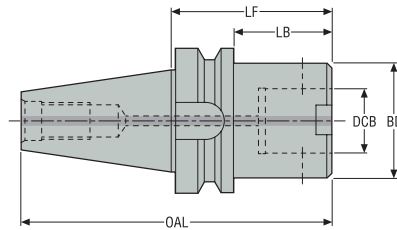

Disegno 2

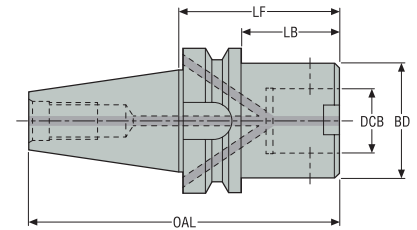

Codice di ordinazione	Codice prodotto	CTMS	CTWS	DCB	LF	LB	BD	OAL	Disegno	Sede RFID	Equilibratura	Peso
				mm Inch	mm Inch	mm Inch	mm Inch	mm Inch				kg lb
EM40024011850	02998757	BT30 TF AD	G3	18,0 0.709	50,0 1.969	28,0 1.102	32,0 1.260	98,4 3.874	1	0	G6.3	0,6 1.320
EM40024012250	02998758	BT30 TF AD	G4	22,0 0.866	50,0 1.969	28,0 1.102	40,0 1.575	98,4 3.874	1	0	G6.3	0,6 1.320
EM321440122100	02998754	BT40 TF ADB	G4	22,0 0.866	100,0 3.937	73,0 2.874	40,0 1.575	165,4 6.512	2	1	G6.3	1,6 3.530
EM321440128120	02926006	BT40 TF ADB	G5	28,0 1.102	120,0 4.724	93,0 3.661	50,0 1.969	185,4 7.299	2	1	PB	2,2 4.850
EM321440136120	02998755	BT40 TF ADB	G6	36,0 1.417	120,0 4.724	93,0 3.661	63,0 2.480	185,4 7.299	2	1	PB	2,8 6.170
EM321640128140	02998756	BT50 TF ADB	G5	28,0 1.102	140,0 5.512	102,0 4.016	50,0 1.969	241,8 9.520	2	1	PB	4,9 10.800
EM321640136140	02926009	BT50 TF ADB	G6	36,0 1.417	140,0 5.512	102,0 4.016	63,0 2.480	241,8 9.520	2	1	PB	5,6 12.350
EM321640146200	02926010	BT50 TF ADB	G7	46,0 1.811	200,0 7.874	162,0 6.378	90,0 3.543	301,8 11.882	2	1	PB	10,8 23.810

Accessori



Per

Chiave di bloccaggio

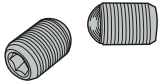

EM40024011850	03H03
EM40024012250	03H04
EM321440122100	03H04
EM321440128120	03H05
EM321440136120	03H06
EM321640128140	03H05
EM321640136140	03H06
EM321640146200	03H10

Parti di ricambio, comprese nella fornitura

Per	Vite di assemblaggio	Sealing Screws
		
EM40024011850	90F3	-
EM40024012250	90F4	-
EM321440122100	90F4	950A0406
EM321440128120	90F5	950A0406
EM321440136120	90F6	950A0406
EM321640128140	90F5	950A0606
EM321640136140	90F6	950A0606
EM321640146200	90F7	950A0606

Introduzione

Foratura

Alesatura

Barenatura

Allegato

G 401 – Adattatori Graflex®

CAT / ASME B5.50-1994-ADB

Introduzione



Disegno 1

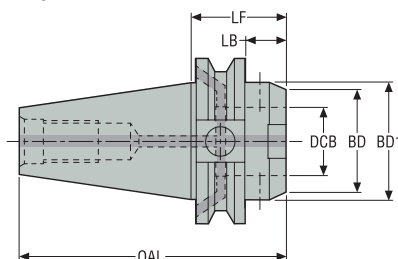

Disegno 2

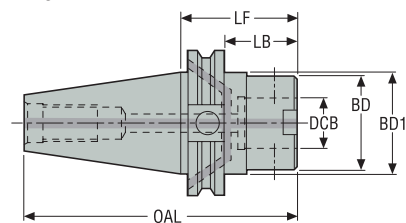

Foratura

Codice di ordinazione	Codice prodotto	CTMS	CTWS	DCB	LF	LB	BD1	BD	OAL	Disegno	Sede RFID	Equilibratura	Peso
				Inch	Inch	Inch	Inch	Inch	Inch				lb
EM25024011435	02469734	CAT40 ADB	G2	0.551	1.380	0.630	1.750	0.984	4.070	1	1	G6.3	2.120
EM25024011835	00056660	CAT40 ADB	G3	0.709	1.380	0.630	1.750	1.260	4.070	1	1	G6.3	2.200
EM25024012235	00056661	CAT40 ADB	G4	0.866	1.380	0.630	1.750	1.575	4.070	1	1	G6.3	1.980
EM25024012840	00056663	CAT40 ADB	G5	1.102	1.570	0.820	1.750	1.969	4.270	2	1	PB	1.980
EM250240128100	00056662	CAT40 ADB	G5	1.102	3.940	3.190	1.750	1.969	7.420	2	1	PB	3.970
EM25024013660	00056665	CAT40 ADB	G6	1.417	2.360	1.610	1.750	2.480	5.060	2	1	PB	2.870
EM25044011835	00056666	CAT50 ADB	G3	0.709	1.380	0.630	2.750	1.260	5.380	1	1	G6.3	6.720
EM25044012235	00056667	CAT50 ADB	G4	0.866	1.380	0.630	2.750	1.575	5.380	1	1	G6.3	6.610
EM25044012840	00056669	CAT50 ADB	G5	1.102	1.570	0.820	2.750	1.969	5.580	2	1	PB	6.610
EM250440128100	00056668	CAT50 ADB	G5	1.102	3.940	3.190	2.750	1.969	7.940	2	1	PB	8.380
EM25044013645	00056671	CAT50 ADB	G6	1.417	1.770	1.020	2.750	2.480	5.780	1	1	PB	6.610
EM250440136120	00056670	CAT50 ADB	G6	1.417	4.720	3.970	2.750	2.480	9.520	1	1	PB	10.360
EM25044014665	00056675	CAT50 ADB	G7	1.811	2.560	1.810	2.750	3.543	5.970	2	1	PB	8.380
EM250440146120	00056673	CAT50 ADB	G7	1.811	4.720	3.970	2.750	3.543	8.730	2	1	PB	13.890
EM250440146200	00056674	CAT50 ADB	G7	1.811	7.870	7.120	2.750	3.543	11.880	2	1	PB	22.270

Alesatura

Accessori

Barenatura

Per dimensione	Chiave di bloccaggio
CAT40/ G2	03H025
CAT40/ G3	03H03
CAT40/ G4	03H04
CAT40/ G5	03H05
CAT40/ G6	03H06
CAT50/ G3	03H03
CAT50/ G4	03H04
CAT50/ G5	03H05
CAT50/ G6	03H06
CAT50/ G7	03H10

Allegato



Parti di ricambio, comprese nella fornitura

Per dimensione	Vite di assemblaggio	Sealing Screws
		
CAT40/ G2	90F2	950A0406
CAT40/ G3	90F3	950A0406
CAT40/ G4	90F4	950A0406
CAT40/ G5	90F5	950A0406
CAT40/ G6	90F6	950A0406
CAT50/ G3	90F3	950A0606
CAT50/ G4	90F4	950A0606
CAT50/ G5	90F5	950A0606
CAT50/ G6	90F6	950A0606
CAT50/ G7	90F7	950A0606

Introduzione

Foratura

Alesatura

Barenatura

Allegato

G 401 – Adattatori Graflex®

CAT TF / ASME B5.50-2009-ADB

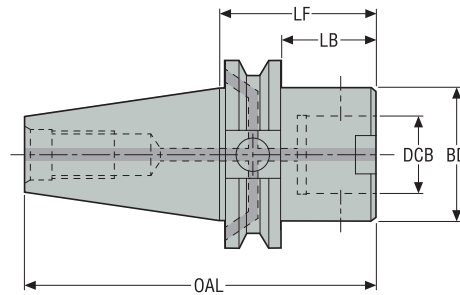



Codice di ordinazione	Codice prodotto	CTMS	CTWS	DCB	LF	LB	BD	OAL	Disegno	Sede RFID	Equilibratura	Peso
				Inch	Inch	Inch	Inch	Inch				lb
EM26424011880	02998750	CAT40 TF ADB	G3	0.709	3.150	2.398	1.260	5.843	2	1	G6.3	2.650
EM26424012280	02998751	CAT40 TF ADB	G4	0.866	3.150	2.398	1.575	5.843	2	1	G6.3	3.090
EM264240128100	02998752	CAT40 TF ADB	G5	1.102	3.937	3.185	1.969	6.630	2	1	PB	4.190
EM264240136100	02998753	CAT40 TF ADB	G6	1.417	3.937	3.185	2.480	6.630	2	1	PB	5.290
EM264440122100	02964322	CAT50 TF ADB	G4	0.866	3.937	3.185	1.575	7.943	2	1	G6.3	7.280
EM264440128100	02964323	CAT50 TF ADB	G5	1.102	3.937	3.185	1.969	7.943	2	1	PB	7.940
EM264440136120	02926850	CAT50 TF ADB	G6	1.417	4.724	3.972	2.480	8.732	1	1	PB	10.140
EM264440146200	02926851	CAT50 TF ADB	G7	1.811	7.874	7.122	3.543	11.880	2	1	PB	22.710

Accessori

Per dimensione	Chiave di bloccaggio
EM26424011880	03H03
EM26424012280	03H04
EM264240128100	03H05
EM264240136100	03H06
EM264440122100	03H04
EM264440128100	03H05
EM264440136120	03H06
EM264440146200	03H10

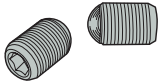

Parti di ricambio, comprese nella fornitura

Per dimensione	Vite di assemblaggio	Sealing Screws
		
EM26424011880	90F3	950A0406
EM26424012280	90F4	950A0406
EM264240128100	90F5	950A0406
EM264240136100	90F6	950A0406
EM264440122100	90F4	950A0606
EM264440128100	90F5	950A0606
EM264440136120	90F6	950A0606
EM264440146200	90F7	950A0606

Introduzione

Foratura

Alesatura

Barenatura

Allegato

G 401 – Adattatori Graflex®

Seco-Capto™

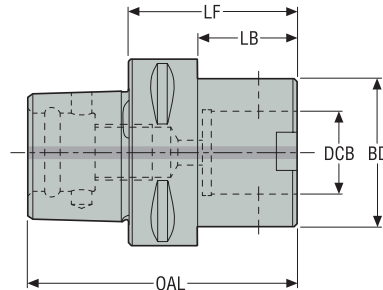

Codice di ordinazione	Codice prodotto	CTMS	CTWS	DCB	LF	LB	BD	OAL	Sede RFID	Equilibratura	Peso
				mm Inch	mm Inch	mm Inch	mm Inch	mm Inch			kg lb
C3-391.0401-08025	02532939	C3	G0	8,0 0.315	25,0 0.984	7,0 0.276	16,0 0.630	44,0 1.732	0	G6.3	0,2 0.440
C3-391.0401-11025	02532940	C3	G1	11,0 0.433	25,0 0.984	7,0 0.276	20,0 0.787	44,0 1.732	0	G6.3	0,14 0.310
C3-391.0401-14025	02532941	C3	G2	14,0 0.551	25,0 0.984	7,0 0.276	25,0 0.984	44,0 1.732	0	G6.3	0,2 0.440
C3-391.0401-18030	02532942	C3	G3	18,0 0.709	30,0 1.181	0,0 -	32,0 1.260	49,0 1.929	0	G6.3	0,16 0.350
C4-391.0401-18035	02532943	C4	G3	18,0 0.709	35,0 1.378	12,0 0.472	32,0 1.260	59,0 2.323	0	G6.3	0,4 0.880
C4-391.0401-22035	02532944	C4	G4	22,0 0.866	35,0 1.378	0,0 -	40,0 1.575	59,0 2.323	0	G6.3	0,31 0.680
C5-391.0401-14030	02532945	C5	G2	14,0 0.551	30,0 1.181	7,0 0.276	25,0 0.984	60,0 2.362	1	G6.3	0,47 1.040
C5-391.0401-18035	02532947	C5	G3	18,0 0.709	35,0 1.378	12,0 0.472	32,0 1.260	65,0 2.559	1	G6.3	0,5 1.100
C5-391.0401-22035	02532948	C5	G4	22,0 0.866	35,0 1.378	12,0 0.472	40,0 1.575	65,0 2.559	1	G6.3	0,5 1.100
C5-391.0401-28045	02532949	C5	G5	28,0 1.102	45,0 1.772	22,0 0.866	50,0 1.969	75,0 2.953	1	PB	0,64 1.410
C6-391.0401-18035	02532950	C6	G3	18,0 0.709	35,0 1.378	10,0 0.394	32,0 1.260	73,0 2.874	1	G6.3	0,9 1.980
C6-391.0401-22040	02532951	C6	G4	22,0 0.866	40,0 1.575	15,0 0.591	40,0 1.575	78,0 3.071	1	G6.3	0,9 1.980
C6-391.0401-28050	02532952	C6	G5	28,0 1.102	50,0 1.969	25,0 0.984	50,0 1.969	88,0 3.465	1	PB	1,1 2.430
C6-391.0401-36055	02532953	C6	G6	36,0 1.417	55,0 2.165	0,0 -	63,0 2.480	93,0 3.661	1	PB	1,2 2.650
C8-391.0401-28050	02532954	C8	G5	28,0 1.102	50,0 1.969	17,0 0.669	50,0 1.969	98,0 3.858	1	PB	2,0 4.410
C8-391.0401-36055	02532955	C8	G6	36,0 1.417	55,0 2.165	22,0 0.866	63,0 2.480	103,0 4.055	1	PB	2,1 4.630
C8-391.0401-46065	02532956	C8	G7	46,0 1.811	65,0 2.559	35,0 1.378	90,0 3.543	113,0 4.449	1	PB	2,71 5.970

Introduzione

Foratura

Alesatura

Barenatura

Allegato

Accessori

Per dimensione	Chiave di bloccaggio
	
G0	03H02
G1	03H02
G2	03H025
G3	03H03
G4	03H04
G5	03H05
G6	03H06
G7	03H10

Parti di ricambio, comprese nella fornitura

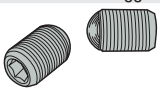
Per dimensione	Vite di assemblaggio
	
G0	90F0
G1	90F1
G2	90F2
G3	90F3
G4	90F4
G5	90F5
G6	90F6
G7	90F7

Introduzione

Foratura

Alesatura

Barenatura

Allegato

G 402 – Prolunghe Graflex®

Graflex®

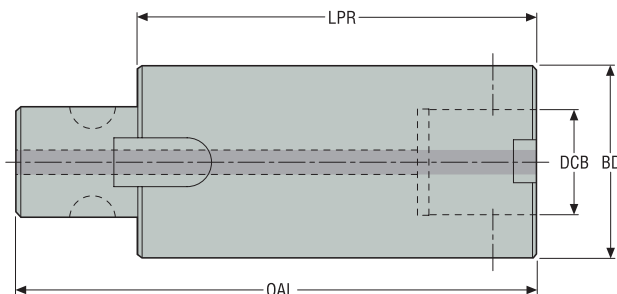



Codice di ordinazione	Codice prodotto	CTMS	CTWS	LPR	DCB	BD	OAL	Sede RFID	Equilibra- tura	Peso
				mm Inch	mm Inch	mm Inch	mm Inch			
M402000	00056752	G0	G0	30,0 1.181	8,0 0.315	16,0 0.630	42,0 1.654	0	PB	0,1 0.220
M402001	00056753	G0	G0	50,0 1.969	8,0 0.315	16,0 0.630	62,0 2.441	0	PB	0,1 0.220
M402110	00056754	G1	G1	30,0 1.181	11,0 0.433	20,0 0.787	43,0 1.693	0	PB	0,1 0.220
M402111	00056755	G1	G1	50,0 1.969	11,0 0.433	20,0 0.787	63,0 2.480	0	PB	0,2 0.440
M402220	00056756	G2	G2	30,0 1.181	14,0 0.551	25,0 0.984	46,0 1.811	0	PB	0,2 0.440
M402221	00056757	G2	G2	50,0 1.969	14,0 0.551	25,0 0.984	66,0 2.598	0	PB	0,2 0.440
M402330	00056758	G3	G3	40,0 1.575	18,0 0.709	32,0 1.260	60,0 2.362	0	PB	0,3 0.660
M402331	75056759	G3	G3	60,0 2.362	18,0 0.709	32,0 1.260	80,0 3.150	0	PB	0,4 0.880
M402440	00056760	G4	G4	40,0 1.575	22,0 0.866	40,0 1.575	64,0 2.520	0	PB	0,4 0.880
M402441	00056761	G4	G4	60,0 2.362	22,0 0.866	40,0 1.575	84,0 3.307	0	PB	0,6 1.320
M402444	02786252	G4	G4	200,0 7.874	22,0 0.866	40,0 1.575	224,0 8.819	0	PB	1,95 4.300
M402550	00056762	G5	G5	50,0 1.969	28,0 1.102	50,0 1.969	80,0 3.150	0	PB	0,8 1.760
M402551	00056763	G5	G5	75,0 2.953	28,0 1.102	50,0 1.969	105,0 4.134	0	PB	1,2 2.650
M402552	00056764	G5	G5	100,0 3.937	28,0 1.102	50,0 1.969	130,0 5.118	0	PB	1,5 3.310
M402554	02786254	G5	G5	250,0 9.843	28,0 1.102	50,0 1.969	280,0 11.024	0	PB	3,8 8.380
M402660	00056765	G6	G6	60,0 2.362	36,0 1.417	63,0 2.480	100,0 3.937	0	PB	1,4 3.090
M402661	00056766	G6	G6	90,0 3.543	36,0 1.417	63,0 2.480	130,0 5.118	0	PB	2,2 4.850
M402662	00056767	G6	G6	120,0 4.724	36,0 1.417	63,0 2.480	160,0 6.299	0	PB	2,9 6.390
M402664	02786255	G6	G6	300,0 11.811	36,0 1.417	63,0 2.480	340,0 13.386	0	PB	7,2 15.870
M402770	00056768	G7	G7	60,0 2.362	46,0 1.811	90,0 3.543	110,0 4.331	0	-	2,9 6.390
M402771	00056769	G7	G7	90,0 3.543	46,0 1.811	90,0 3.543	140,0 5.512	0	-	4,4 9.700

Codice di ordinazione	Codice prodotto	CTMS	CTWS	LPR	DCB	BD	OAL	Sede RFID	Equilibratura	Peso
				mm Inch	mm Inch	mm Inch	mm Inch			kg lb
M402772	00056770	G7	G7	120,0 4.724	46,0 1.811	90,0 3.543	170,0 6.693	0	-	5,8 12.790
M402774	02786257	G7	G7	300,0 11.811	46,0 1.811	90,0 3.543	350,0 13.780	0	-	14,6 32.190

Accessori

Per dimensione	Chiave di bloccaggio
	
G0	03H02
G1	03H02
G2	03H025
G3	03H03
G4	03H04
G5	03H05
G6	03H06
G7	03H10

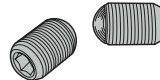
Parti di ricambio, comprese nella fornitura

Per dimensione	Vite di assemblaggio	Tenone
		
G0	90F0	90M0
G1	90F1	90M1
G2	90F2	90M2
G3	90F3	90M3
G4	90F4	90M4
G5	90F5	90M5
G6	90F6	90M6
G7	90F7	90M7

G 403 – Riduzioni Graflex®

Graflex®

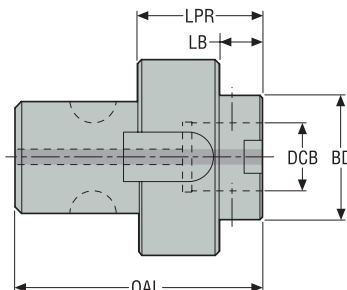

Codice di ordinazione	Codice prodotto	CTMS	CTWS	LPR	LB	DCB	BD	OAL	Sede RFID	Equilibratura	Peso
				mm <i>Inch</i>	mm <i>Inch</i>	mm <i>Inch</i>	mm <i>Inch</i>	mm <i>Inch</i>			
M40310	00056771	G1	G0	30,0 1.181	22,0 0.866	8,0 0.315	16,0 0.630	43,0 1.693	0	PB	0,1 0.220
M40320	00056772	G2	G0	30,0 1.181	19,0 0.748	8,0 0.315	16,0 0.630	46,0 1.811	0	PB	0,1 0.220
M40321	00056773	G2	G1	30,0 1.181	19,0 0.748	11,0 0.433	20,0 0.787	46,0 1.811	0	PB	0,1 0.220
M40330	00056774	G3	G0	30,0 1.181	16,0 0.630	8,0 0.315	16,0 0.630	50,0 1.969	0	PB	0,2 0.440
M40331	00056775	G3	G1	30,0 1.181	16,0 0.630	11,0 0.433	20,0 0.787	50,0 1.969	0	PB	0,15 0.330
M40332	00056776	G3	G2	30,0 1.181	16,0 0.630	14,0 0.551	25,0 0.984	50,0 1.969	0	PB	0,2 0.440
M40341	00056778	G4	G1	30,0 1.181	13,0 0.512	11,0 0.433	20,0 0.787	54,0 2.126	0	PB	0,25 0.550
M40342	00056779	G4	G2	30,0 1.181	13,0 0.512	14,0 0.551	25,0 0.984	54,0 2.126	0	PB	0,3 0.660
M40343	00056780	G4	G3	30,0 1.181	13,0 0.512	18,0 0.709	32,0 1.260	54,0 2.126	0	PB	0,3 0.660
M40350	00056781	G5	G0	40,0 1.575	20,0 0.787	8,0 0.315	16,0 0.630	70,0 2.756	0	PB	0,47 1.040
M40351	00056783	G5	G1	40,0 1.575	20,0 0.787	11,0 0.433	20,0 0.787	70,0 2.756	0	PB	0,5 1.100
M40352	00056785	G5	G2	40,0 1.575	20,0 0.787	14,0 0.551	25,0 0.984	70,0 2.756	0	PB	0,5 1.100
M40353	00056787	G5	G3	40,0 1.575	20,0 0.787	18,0 0.709	32,0 1.260	70,0 2.756	0	PB	0,6 1.320
M40354	00056789	G5	G4	40,0 1.575	20,0 0.787	22,0 0.866	40,0 1.575	70,0 2.756	0	PB	0,6 1.320
M40363	00056797	G6	G3	40,0 1.575	14,0 0.551	18,0 0.709	32,0 1.260	80,0 3.150	0	PB	1,0 2.200
M40364	00056799	G6	G4	40,0 1.575	14,0 0.551	22,0 0.866	40,0 1.575	80,0 3.150	0	PB	1,0 2.200
M40365	00056807	G6	G5	45,0 1.772	19,0 0.748	28,0 1.102	50,0 1.969	85,0 3.346	0	PB	1,1 2.430
M40375	00056811	G7	G5	50,0 1.969	24,0 0.945	28,0 1.102	50,0 1.969	100,0 3.937	0	-	2,1 4.630
M40376	00056812	G7	G6	55,0 2.165	29,0 1.142	36,0 1.417	63,0 2.480	105,0 4.134	0	-	2,3 5.070

Introduzione

Foratura

Alesatura

Barenatura

Allegato

Accessori

Per dimensione	Chiave di bloccaggio
	
M40310	03H02
M40320	03H02
M40321	03H02
M40330	03H02
M40331	03H02
M40332	03H025
M40341	03H02
M40342	03H025
M40343	03H03
M40350	03H02
M40351	03H02
M40352	03H025
M40353	03H03
M40354	03H04
M40363	03H03
M40364	03H04
M40365	03H05
M40375	03H05
M40376	03H06

Parti di ricambio, comprese nella fornitura

Per dimensione	Vite di assemblaggio	Tenone
		
M40310	90F0	90M1
M40320	90F0	90M2
M40321	90F1	90M2
M40330	90F0	90M3
M40331	90F1	90M3
M40332	90F2	90M3
M40341	90F1	90M4
M40342	90F2	90M4
M40343	90F3	90M4
M40350	90F0	90M5
M40351	90F1	90M5
M40352	90F2	90M5
M40353	90F3	90M5
M40354	90F4	90M5
M40363	90F3	90M6
M40364	90F4	90M6
M40365	90F5	90M6
M40375	90F5	90M7
M40376	90F6	90M7

Introduzione

Foratura

Alesatura

Barenatura

Allegato

G 403 – Riduzioni lunghe Graflex®

Graflex®

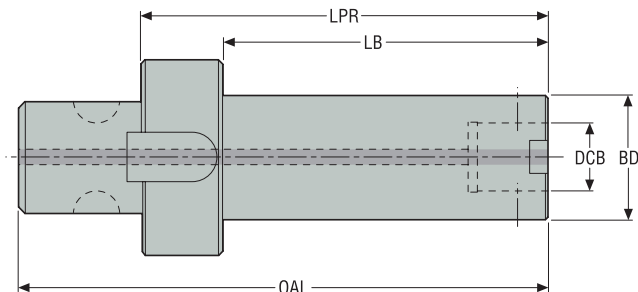



Codice di ordinazione	Codice prodotto	CTMS	CTWS	LPR	LB	DCB	BD	OAL	Sede RFID	Equilibratura	Peso
				mm <i>Inch</i>	mm <i>Inch</i>	mm <i>Inch</i>	mm <i>Inch</i>	mm <i>Inch</i>			kg <i>lb</i>
M40350070	00056782	G5	G0	70,0 2.756	50,0 1.969	8,0 0.315	16,0 0.630	100,0 3.937	0	PB	0,6 1.320
M40351080	00056784	G5	G1	80,0 3.150	60,0 2.362	11,0 0.433	20,0 0.787	110,0 4.331	0	PB	0,6 1.320
M40352100	00056786	G5	G2	100,0 3.937	80,0 3.150	14,0 0.551	25,0 0.984	130,0 5.118	0	PB	0,8 1.760
M40353120	00056788	G5	G3	120,0 4.724	100,0 3.937	18,0 0.709	32,0 1.260	150,0 5.906	0	PB	1,02 2.250
M40354150	00056790	G5	G4	150,0 5.906	130,0 5.118	22,0 0.866	40,0 1.575	180,0 7.087	0	PB	1,7 3.750
M40361090	00056794	G6	G1	90,0 3.543	64,0 2.520	11,0 0.433	20,0 0.787	130,0 5.118	0	PB	1,08 2.380
M40362110	00056796	G6	G2	110,0 4.331	84,0 3.307	14,0 0.551	25,0 0.984	150,0 5.906	0	PB	1,3 2.870
M40363120	00056798	G6	G3	120,0 4.724	94,0 3.701	18,0 0.709	32,0 1.260	160,0 6.299	0	PB	1,5 3.310
M40364150	00056800	G6	G4	150,0 5.906	124,0 4.882	22,0 0.866	40,0 1.575	190,0 7.480	0	PB	2,1 4.630
M40365190	00056808	G6	G5	190,0 7.480	164,0 6.457	28,0 1.102	50,0 1.969	230,0 9.055	0	PB	3,3 7.280

Accessori

Per dimensione	Chiave di bloccaggio
M40350070	03H02
M40351080	03H02
M40352100	03H025
M40353120	03H03
M40354150	03H04
M40361090	03H02
M40362110	03H025
M40363120	03H03
M40364150	03H04
M40365190	03H05

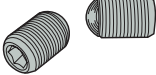

Parti di ricambio, comprese nella fornitura

Per dimensione	Vite di assemblaggio	Tenone
		
M40350070	90F0	90M5
M40351080	90F1	90M5
M40352100	90F2	90M5
M40353120	90F3	90M5
M40354150	90F4	90M5
M40361090	90F1	90M6
M40362110	90F2	90M6
M40363120	90F3	90M6
M40364150	90F4	90M6
M40365190	90F5	90M6

Introduzione

Foratura

Alesatura

Barenatura

Allegato

G 403 – Maggiorazioni Graflex®

Graflex®

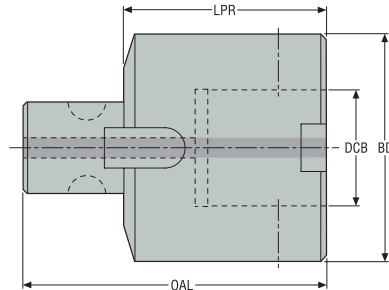

Codice di ordinazione	Codice prodotto	CTMS	CTWS	LPR	DCB	BD	OAL	Sede RFID	Equilibra- tura	Peso
				mm <i>Inch</i>	mm <i>Inch</i>	mm <i>Inch</i>	mm <i>Inch</i>			kg <i>lb</i>
M40356	00056791	G5	G6	55,0 2.165	36,0 1.417	63,0 2.480	85,0 3.346	0	PB	1,1 2.430
M40367	00056810	G6	G7	80,0 3.150	46,0 1.811	90,0 3.543	120,0 4.724	0	PB	3,5 7.720

Accessori

Per	Chiave di bloccaggio
M40356	03H06
M40367	03H10

Parti di ricambio, comprese nella fornitura

Per	Vite di assemblaggio	Tenone
M40356	90F6	90M5
M40367	90F7	90M6

Introduzione

Foratura

Alesatura

Barenatura

Allegato

G 401 – Adattatori Graflex®, acciaio

Cilindrico

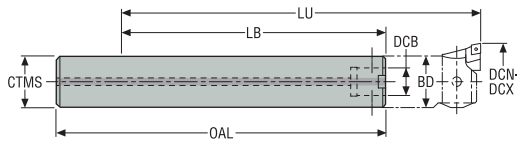

- Per lunghezza di barenatura di finitura fino a LU con testine di tipo A780 o A790
- Connessione lato macchina cilindrica CTMS con tolleranza h5, compatibile per calettamento termico

Codice di ordinazione	Codice prodotto	CTMS	CTWS	DCB	DCN	DCX	OAL	BD	LU	LB	Sede RFID	Equilibratura	Peso
				mm Inch	mm Inch	mm Inch	mm Inch	mm Inch	mm Inch	mm Inch			kg lb
M4011408	00086938	14	G0	8,0 0.315	15,0 0.591	18,5 0.728	120,0 4.724	14,0 0.551	110,0 4.331	75,0 2.953	0	G6.3	0,2 0.440
M4011608	00086935	16	G0	8,0 0.315	18,0 0.709	23,5 0.925	150,0 5.906	16,0 0.630	137,0 5.394	102,0 4.016	0	G6.3	0,3 0.660
M4012011	00086936	20	G1	11,0 0.433	23,0 0.906	31,0 1.220	150,0 5.906	20,0 0.787	140,0 5.512	100,0 3.937	0	G6.3	0,33 0.730
M4012514	00086937	25	G2	14,0 0.551	30,0 1.181	40,0 1.575	150,0 5.906	25,0 0.984	139,0 5.472	93,0 3.661	0	G6.3	0,6 1.320
M4013218	00086939	32	G3	18,0 0.709	39,0 1.535	51,0 2.008	150,0 5.906	32,0 1.260	155,0 6.102	90,0 3.543	0	G6.3	0,9 1.980

Parti di ricambio, comprese nella fornitura

Per	Vite di assemblaggio
M4011408	90F01
M4011608	90F0
M4012011	90F1
M4012514	90F2
M4013218	90F3

Accessori

Per	Chiave di bloccaggio
M4011408	03H025
M4011608	03H02
M4012011	03H02
M4012514	03H025
M4013218	03H03

Introduzione

Foratura

Alesatura

Barenatura

Allegato

G 401 – Adattatori Graflex®, acciaio

Cilindrico

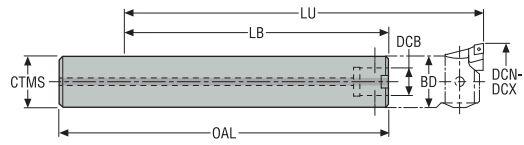

- Per lunghezza di barenatura di finitura fino a LU con testine di tipo A780 o A790
- Connessione lato macchina cilindrica CTMS con tolleranza h5, compatibile per calettamento termico

Codice di ordinazione	Codice prodotto	CTMS	CTWS	DCB	DCN	DCX	OAL	BD	LU	LB	Sede RFID	Equilibratura	Peso
		<i>Inch</i>		<i>Inch</i>	<i>Inch</i>	<i>Inch</i>	<i>Inch</i>	<i>Inch</i>	<i>Inch</i>	<i>Inch</i>			<i>lb</i>
M40107511	00056741	0.750	G1	0.433	0.906	1.220	5.906	0.827	5.510	3.906	0	G6.3	0.660

Parti di ricambio, comprese nella fornitura

Per	Vite di assemblaggio	Chiave di bloccaggio
M40107511	90F1	03H02

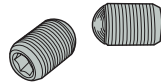

Introduzione

Foratura

Alesatura

Barenatura

Allegato

G 401 – Adattatori Graflex®, metallo duro

Cilindrico

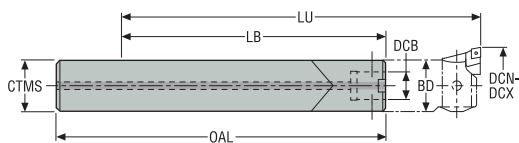

- Per lunghezza di barenatura di finitura fino a LU con testine di tipo A780 o A790
- CTMS tolleranza h5

Codice di ordinazione	Codice prodotto	CTMS	CTWS	DCB	DCN	DCX	OAL	BD	LU	LB	Sede RFID	Equilibratura	Peso
				mm Inch	mm Inch	mm Inch	mm Inch	mm Inch	mm Inch	mm Inch			kg lb
M4011408C	00073004	14	G0	8,0 0.315	15,0 0.591	18,5 0.728	152,0 5.984	14,0 0.551	140,0 5.512	105,0 4.134	0	G6.3	0,3 0.660
M4011608C	00056747	16	G0	8,0 0.315	18,0 0.709	23,5 0.925	175,0 6.890	16,0 0.630	160,0 6.299	125,0 4.921	0	G6.3	0,5 1.100
M4012011C	00056749	20	G1	11,0 0.433	23,0 0.906	31,0 1.220	212,0 8.346	20,0 0.787	200,0 7.874	160,0 6.299	0	G6.3	0,9 1.980
M4012514C	00056750	25	G2	14,0 0.551	30,0 1.181	40,0 1.575	262,0 10.315	25,0 0.984	250,0 9.843	204,0 8.031	0	G6.3	1,71 3.770
M4013218C	00056751	32	G3	18,0 0.709	39,0 1.535	51,0 2.008	317,0 12.480	32,0 1.260	320,0 12.598	255,0 10.039	0	G6.3	3,44 7.580

Parti di ricambio, comprese nella fornitura

Per	Vite di assemblaggio
M4011408C	90F01
M4011608C	90F0
M4012011C	90F1
M4012514C	90F2
M4013218C	90F3

Accessori

Per	Chiave di bloccaggio
M4011408C	03H025
M4011608C	03H02
M4012011C	03H02
M4012514C	03H025
M4013218C	03H03

Introduzione

Foratura

Alesatura

Barenatura

Allegato

G 403 – Riduzioni extra lunghe, Graflex®, metallo duro

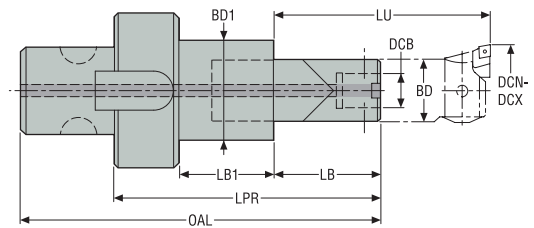

- La prolunga è realizzata in metallo duro
- Per lunghezza di barenatura di finitura fino a LU con testine di tipo A780 o A790

Codice di ordinazione	Codice prodotto	CTMS	CTWS	DCB	DCN	DCX	LPR	LU	BD	BD1	LB1	LB	OAL	Sede RFID	Equilibratura	Peso
				mm Inch	mm Inch	mm Inch	mm Inch	mm Inch	mm Inch	mm Inch	mm Inch	mm Inch	mm Inch			kg lb
M40350C150	00057604	G5	G0	8,0 0.315	18,0 0.709	23,5 0.925	150,0 5.906	130,0 5.118	16,0 0.630	32,0 0.630	35,0 1.378	95,0 3.740	180,0 7.087	0	PB	1,0 2.200
M40351C180	00056943	G5	G1	11,0 0.433	23,0 0.906	31,0 1.220	180,0 7.087	160,0 6.299	20,0 0.787	36,0 0.787	40,0 1.575	120,0 4.724	210,0 8.268	0	PB	1,4 3.090
M40352C220	00057605	G5	G2	14,0 0.551	30,0 1.181	40,0 1.575	220,0 8.661	200,0 7.874	25,0 0.984	41,0 0.984	45,0 1.772	155,0 6.102	250,0 9.843	0	PB	2,01 4.430

Parti di ricambio, comprese nella fornitura

Per	Vite di assemblaggio	Tenone
M40350C150	90F0	90M5
M40351C180	90F1	90M5
M40352C220	90F2	90M5

Accessori

Per	Chiave di bloccaggio
M40350C150	03H02
M40351C180	03H02
M40352C220	03H025

Tubi del refrigerante, chiavi e grani di tenuta HSK

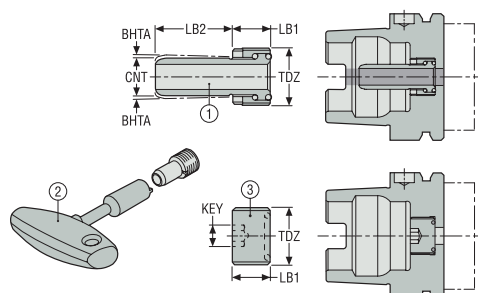

- Gli attacchi base da HSK-A a Seco-Capto sono forniti con uno specifico tubo del refrigerante, disponibile come ricambio, e necessitano di una specifica chiave per tubi del refrigerante, vedere pag. prodotto 554, 555-556, 557

Descrizione	Codice di ordinazione	Codice prodotto	Per attacchi HSK forma A ed E	LB1	LB2	KEY	CNT	TDZ	BHTA°
				mm Inch	mm Inch	mm Inch	mm		
Tubi refrigerante (1)*	20E9301	00088814	HSK-A32 & HSK-E32	5,5 0.217	20,5 0.807	-	6	M10x1	1,0
	20E9302	00088815	HSK-A40 & HSK-E40	7,5 0.295	22,0 0.866	-	8	M12x1	1,0
	20E9303	00086740	HSK-A50 & HSK-E50	9,5 0.374	23,5 0.925	-	6	M16x1	1,0
	20E9304	00086741	HSK-A63 & HSK-E63	11,5 0.453	25,0 0.984	-	8	M18x1	1,0
	20E9306	00086742	HSK-A100 & HSK-E100	15,5 0.610	28,5 1.122	-	6	M24x1,5	1,0
	20E9307	00088816	HSK-A125	17,5 0.689	30,5 1.201	-	18	M30x1.5	1,0
	Chiavi per tubi refrigerante (2)	03E9301	00088811	HSK-A32 & HSK-E32	-	-	-	-	-
03E9302		00088812	HSK-A40 & HSK-E40	-	-	-	-	-	-
03E9303		00069969	HSK-A50 & HSK-E50	-	-	-	-	-	-
03E9304		00069970	HSK-A63 & HSK-E63	-	-	-	-	-	-
03E9305		00032296	HSK-A80 & HSK-E80	-	-	-	-	-	-
03E9306		00084012	HSK-A100 & HSK-E100	-	-	-	-	-	-
5680094-07		03248614	HSK-A125	-	-	-	-	-	-
Grani di tenuta (3)	02E9301	00031588	HSK-A32 & HSK-E32	5,0 0.197	-	3,0 0.118	-	M10x1	-
	02E9302	00031593	HSK-A40 & HSK-E40	7,0 0.276	-	4,0 0.157	-	M12x1	-
	02E9303	00001002	HSK-A50 & HSK-E50	9,0 0.354	-	5,0 0.197	-	M16x1	-
	02E9304	00010101	HSK-A63 & HSK-E63	11,0 0.433	-	6,0 0.236	-	M18x1	-
	02E9306	00014002	HSK-A100 & HSK-E100	15,0 0.591	-	10,0 0.394	-	M24x1,5	-
	02E9307	00033649	HSK-A125	17,0 0.669	-	12,0 0.472	-	M30x1.5	-



Seco-Capto™

Seco-Capto™ è un eccellente sistema di utensili modulare a cambio rapido che consente di configurare e sostituire velocemente i corpi utensile. La gamma di utensili modulari Seco-Capto™ utilizza l'accoppiamento PSC (Polygonal Shank Coupling, accoppiamento conico poligonale), in accordo alla norma ISO 26623, ed è dotata di un accoppiamento conico auto-bloccante.

- Gamma di portautensili, ad esempio per calettamento termico, porta pinza e a manicotto
- Attacchi base Seco-Capto™ con connessioni HSK, DIN, BT
- Moduli Seco-Capto™ per una maggiore affidabilità e migliore bloccaggio dell'inserto

Seco-Capto™, Dimensioni secondo normativa

ISO 26623-1-PSC/ ISO 26623-2-PSC

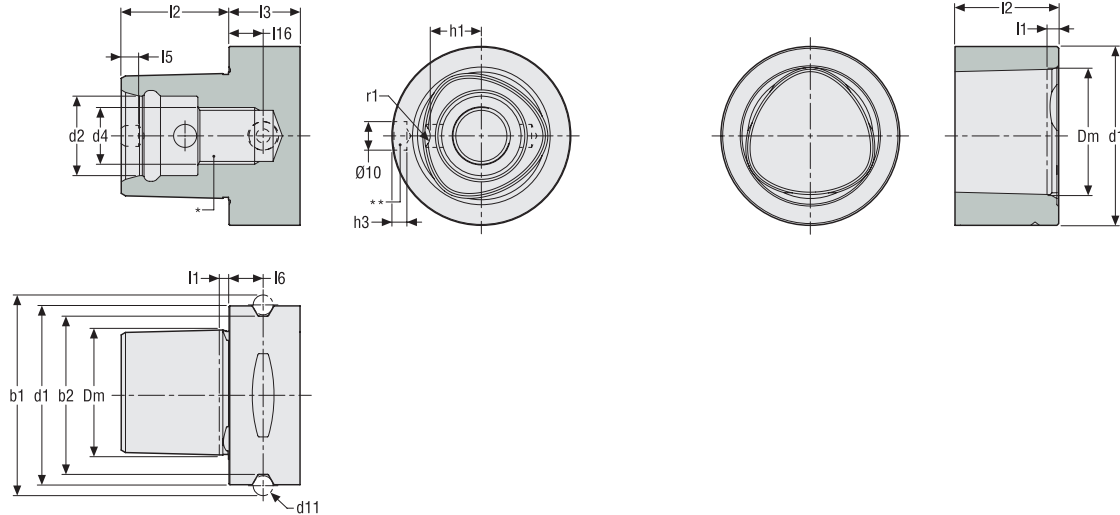

Tipologia lato macchina	Sede per microchip**	d ₁	d ₂	d ₄	d ₁₁	Dm	b ₁	b ₂	l ₁	l ₂	l _{3 min}	l ₅	l ₆	l ₁₆	h ₁	h ₃	r ₁
		mm Inch	mm Inch		mm Inch	mm Inch	mm Inch	mm Inch	mm Inch	mm Inch	mm Inch	mm Inch	mm Inch	mm Inch	mm Inch	mm Inch	mm Inch
C3	No**	32 1.260	15 0.591	M12	5 0.197	22 0.866	39 1.535	28,3 1.114	2,5 0.098	19 0.748	15 0.591	3,2 0.126	6 0.236	9 0.354	9 0.354	5,4 0.213	3 0.118
C4	No**	40 1.575	18 0.709	M14	5 0.197	28 1.102	46 1.811	35,3 1.390	2,5 0.098	24 0.945	20 0.787	4 0.157	8 0.315	12 0.472	11 0.433	5,2 0.205	3 0.118
C5	**	50 1.969	21 0.827	M16	7 0.276	35 1.378	59,3 2.335	44,4 1.748	3 0.118	30 1.181	20 0.787	5,3 0.209	10 0.394	12 0.472	14 0.551	5,1 0.201	4 0.157
C6	**	63 2.480	28 1.102	M20	7 0.276	44 1.732	70,7 2.783	55,8 2.197	3 0.118	38 1.496	22 0.866	6,2 0.244	12 0.472	12 0.472	18 0.709	5 0.197	5 0.197
C8	**	80 3.150	32 1.260	M20	7 0.276	55 2.165	86 3.386	71,1 2.799	3 0.118	48 1.890	30 1.181	8 0.315	12 0.472	12 0.472	22,2 0.874	4,9 0.193	6 0.236

Lato lato macchina	Sede per microchip**	d _{1 min}	d ₃	Dm	l ₁	l ₂	l ₃	l ₄
		mm Inch	mm Inch	mm Inch	mm Inch	mm Inch	mm Inch	mm Inch
C3	No	32 1.260	2 0.079	22 0.866	2,3 0.091	18,4 0.724	16,5 0.650	9,4 0.370
C4	No	40 1.575	2,5 0.098	28 1.102	2,3 0.091	23,4 0.921	21 0.827	11,5 0.453
C5	No	50 1.969	3 0.118	35 1.378	2,8 0.110	29,4 1.157	26 1.024	14,5 0.571
C6	**	63 2.480	4 0.157	44 1.732	2,8 0.110	37,4 1.472	33,5 1.319	18,5 0.728
C8	**	80 3.150	5 0.197	55 2.165	2,8 0.110	47,4 1.866	43 1.693	22,8 0.898

Nota: Queste norme dimensionali lato macchina e lato utensile sono applicate a tutti gli attacchi mostrati nelle pagine di prodotto.

* Le prolunghes Seco-Capto™ versione corta possono essere montate solo direttamente su mandrini o torrette Capto con bloccaggio ad espansione radiale (non con vite centrale). Le riduzioni Seco-Capto™ versione corta possono essere montate solo direttamente su mandrini o torrette Capto con bloccaggio ad espansione radiale (non con vite centrale).

** Per sapere se è presente una sede per il microchip RFID, vedere la colonna "Sede RFID" sulle pagine prodotto: 1= sede per microchip RFID presente, su richiesta un microchip può essere inserito, chiedere informazioni.

0= sede per microchip RFID non presente, su richiesta la sede può essere realizzata ed un microchip può essere inserito, chiedere informazioni.

C 00 – Attacchi da DIN 2080 a Seco-Capto™ – ISO 26623-2

DIN 2080

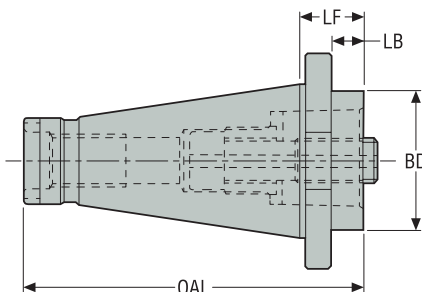

Codice di ordinazione	Codice prodotto	CTMS	CTWS	LF	LB	BD	OAL	Sede RFID	Equilibra- tura	Peso
				mm <i>Inch</i>	mm <i>Inch</i>	mm <i>Inch</i>	mm <i>Inch</i>			kg <i>lb</i>
C3-390.00-40030	75039844	DIN(2080)40	C3	30,0 1.181	18,4 0.724	32,0 1.260	123,4 4.858	0	-	0,9 1.980
C4-390.00-40030	75039848	DIN(2080)40	C4	30,0 1.181	18,4 0.724	40,0 1.575	123,4 4.858	0	-	1,0 2.200
C4-390.00-40060	75039849	DIN(2080)40	C4	60,0 2.362	48,4 1.906	40,0 1.575	153,4 6.039	0	-	1,08 2.380
C5-390.00-40030	75039852	DIN(2080)40	C5	30,0 1.181	18,4 0.724	50,0 1.969	123,4 4.858	0	-	0,81 1.790
C6-390.00-40075	00048158	DIN(2080)40	C6	75,0 2.953	0,0 -	63,0 2.480	168,4 6.630	0	-	1,82 4.010
C3-390.00-50030	75039846	DIN(2080)50	C3	30,0 1.181	14,8 0.583	32,0 1.260	156,8 6.173	0	-	2,5 5.510
C3-390.00-50060	75039847	DIN(2080)50	C3	60,0 2.362	44,8 1.764	32,0 1.260	186,8 7.354	0	-	2,5 5.510
C4-390.00-50030	75039850	DIN(2080)50	C4	30,0 1.181	14,8 0.583	40,0 1.575	156,8 6.173	0	-	2,5 5.510
C4-390.00-50060	75039851	DIN(2080)50	C4	60,0 2.362	44,8 1.764	40,0 1.575	186,8 7.354	0	-	2,5 5.510
C5-390.00-50030	75039854	DIN(2080)50	C5	30,0 1.181	14,8 0.583	50,0 1.969	156,8 6.173	0	-	2,62 5.780
C5-390.00-50070	75039855	DIN(2080)50	C5	70,0 2.756	54,8 2.157	50,0 1.969	196,8 7.748	0	-	3,29 7.250
C6-390.00-50030	75039856	DIN(2080)50	C6	30,0 1.181	14,8 0.583	63,0 2.480	156,8 6.173	0	-	2,56 5.640
C6-390.00-50080	75039857	DIN(2080)50	C6	80,0 3.150	64,8 2.551	63,0 2.480	206,8 8.142	0	-	3,27 7.210
C8-390.00-50070	75039858	DIN(2080)50	C8	70,0 2.756	54,8 2.157	80,0 3.150	196,8 7.748	0	-	3,8 8.380
C8-390.00-50120	75039859	DIN(2080)50	C8	120,0 4.724	104,8 4.126	80,0 3.150	246,8 9.717	0	-	5,6 12.350

Accessori

Per	Chiave di estensione	Chiave
C3	5680015-05	5680065-13
C4	5680015-05	5680065-10
C5	5680015-01	5680065-11
C6-400	5680015-01	5680065-12
C6-500	5680015-02	5680065-12
C8	5680015-02	5680065-12

Introduzione



Foratura

Alesatura

Barenatura

Allegato

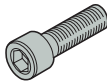
Parti di ricambio, comprese nella fornitura

Per	Vite centrale	Ghiera di bloccaggio
		
C3	5512063-10	5512091-04
C4	5512063-07	5512091-03
C5	5512063-08	5512091-01
C6-400	5512063-13	5512091-02
C6-500	5512063-09	5512091-02
C8	5512063-09	5512091-02

Accessori / Parti di ricambio

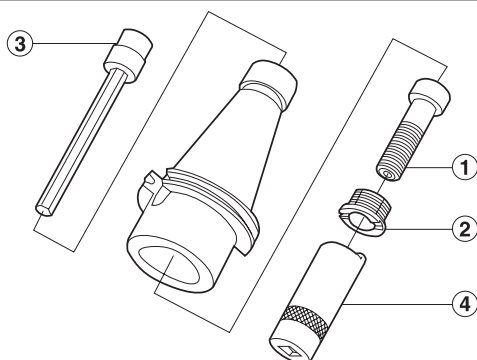

Accessori:
3 = Chiave di prolunga
4 = Chiave

Ricambi:
1 = Vite centrale
2 = Ghiera di fissaggio

C 55/58 – Attacchi da CAT a Seco-Capto™

CAT / ASME B5.50-2009-ADB

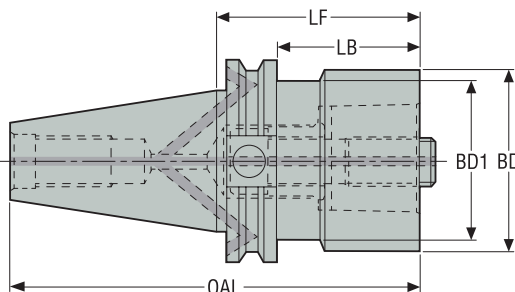



Codice di ordinazione	Codice prodotto	CTMS	CTWS	LF	LB	BD	BD1	OAL	Dise- gno	Sede RFID	Equilibra- tura	Peso
				<i>Inch</i>	<i>Inch</i>	<i>Inch</i>	<i>Inch</i>	<i>Inch</i>				<i>lb</i>
C3-A390B.45-40060	02925929	CAT40 ADB	C3	2.362	1.610	1.260	1.260	5.055	2	0	PB	2.200
C4-A390B.45-40030	02925932	CAT40 ADB	C4	1.181	0.429	1.575	1.575	3.874	2	0	PB	1.980
C4-A390B.45-40060	02925933	CAT40 ADB	C4	2.362	1.610	1.575	1.575	5.055	2	0	PB	2.430
C5-A390B.45-40040	02925935	CAT40 ADB	C5	1.575	0.823	1.969	1.969	4.268	2	0	PB	2.200
C5-A390B.45-40080	02925936	CAT40 ADB	C5	3.150	2.398	1.969	1.969	5.843	2	0	PB	3.310
C6-A390B.45-40085	02925939	CAT40 ADB	C6	3.346	1.378	2.480	2.480	6.039	2	0	PB	4.190
C3-A390B.45-50030	02925930	CAT50 ADB	C3	1.181	0.429	1.260	1.260	5.185	2	0	PB	6.390
C3-A390B.45-50060	02925931	CAT50 ADB	C3	2.362	1.610	1.260	1.260	6.366	2	0	PB	5.970
C4-A390B.45-50030	02925948	CAT50 ADB	C4	1.181	0.429	1.575	1.575	5.185	2	0	PB	5.780
C4-A390B.45-50060	02925934	CAT50 ADB	C4	2.362	1.610	1.969	1.575	6.366	2	0	PB	6.610
C5-A390B.45-50030	02925937	CAT50 ADB	C5	1.181	0.429	1.969	1.969	5.185	2	0	PB	5.290
C5-A390B.45-50070	02925938	CAT50 ADB	C5	2.756	2.004	1.969	1.969	6.760	2	0	PB	6.830
C6-A390B.45-50030	02925940	CAT50 ADB	C6	1.181	0.429	2.480	2.480	5.185	2	0	PB	5.510
C6-A390B.45-50080	02925941	CAT50 ADB	C6	3.150	2.398	2.480	2.480	7.154	2	0	PB	7.940
C8-A390B.45-50070	02925942	CAT50 ADB	C8	2.756	2.004	3.150	3.150	6.760	2	0	PB	8.160
C8-A390B.45-50120	02925943	CAT50 ADB	C8	4.724	3.972	3.150	3.150	8.728	2	0	PB	12.350

Accessori

Per dimensione	Chiave di estensione	Chiave
CAT40/ C3	5680015-05	5680065-13
CAT40/ C4	5680015-05	5680065-10
CAT40/ C5	5680015-01	5680065-11
CAT40/ C6	5680015-01	5680065-12
CAT50/ C3	5680015-05	5680065-13
CAT50/ C4-50030	5680015-05	5680065-10
CAT50/ C4-50060	5680015-05	5680065-10
CAT50/ C5	5680015-01	5680065-11
CAT50/ C6	5680015-02	5680065-12
CAT50/ C8	5680015-02	5680065-12

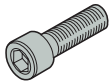
Parti di ricambio, comprese nella fornitura

Per dimensione	Vite centrale	Grano	Ghiera di bloccaggio
			
CAT40/ C3	5512063-10	564301701	5512091-04
CAT40/ C4	5512063-07	564301701	5512091-03
CAT40/ C5	5512063-08	564301701	5512091-01
CAT40/ C6	5512063-13	564301701	5512091-02
CAT50/ C3	5512063-10	564301702	5512091-04
CAT50/ C4-50030	5512063-07	564301701	5512091-03
CAT50/ C4-50060	5512063-07	564301702	5512091-03
CAT50/ C5	5512063-08	564301702	5512091-01
CAT50/ C6	5512063-09	564301702	5512091-02
CAT50/ C8	5512063-09	564301702	5512091-02

Accessori / Parti di ricambio

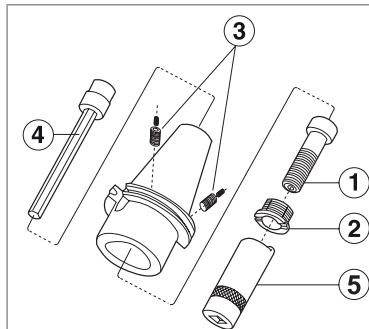

Accessori:
4 = Chiave di prolunga
5 = Chiave

Ricambi:
1 = Vite centrale
2 = Ghiera di fissaggio
3 = Grani (spine)

C 410 – Attacchi da HSK-A a Seco-Capto™ – ISO 26623-2

HSK-A/ ISO12164-1-HSK-A



Disegno 1

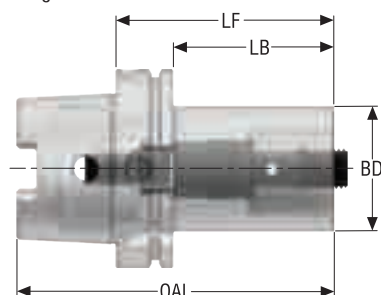

Disegno 2

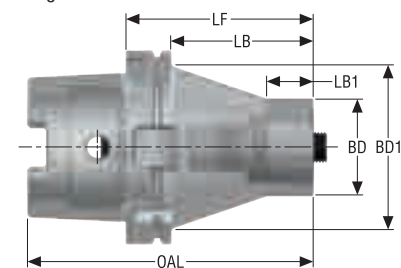

Codice di ordinazione	Codice prodotto	CTMS	CTWS	LF	LB	LB1	BD	BD1	OAL	Disegno	Sede RFID	Equilibratura	Peso
				mm Inch	mm Inch	mm Inch	mm Inch	mm Inch	mm Inch				kg lb
HA10-C3-032-080	10197961	HSK-A100	C3	80,0 3.150	51,0 2.008	-	32,0 1.260	-	130,0 5.118	1	1	PB	2,5 5.510
HA06-C3-032-075	10197962	HSK-A63	C3	75,0 2.953	49,0 1.929	-	32,0 1.260	-	107,0 4.213	1	1	PB	0,9 1.980
HA10-C4-040-090	10197963	HSK-A100	C4	90,0 3.543	61,0 2.402	-	40,0 1.575	-	140,0 5.512	1	1	PB	2,5 5.510
HA06-C4-040-080	10197964	HSK-A63	C4	80,0 3.150	54,0 2.126	-	40,0 1.575	-	112,0 4.409	1	1	PB	1,1 2.430
HA10-C5-050-100	10197965	HSK-A100	C5	100,0 3.937	71,0 2.795	-	50,0 1.969	-	150,0 5.906	1	1	PB	2,9 6.390
HA06-C5-050-090	10197966	HSK-A63	C5	90,0 3.543	64,0 2.520	-	50,0 1.969	-	122,0 4.803	1	1	PB	3,1 6.830
HA10-C6-063-110	10197967	HSK-A100	C6	110,0 4.331	81,0 3.189	-	63,0 2.480	-	160,0 6.299	1	1	PB	3,8 8.380
HA10-C8-080-120	10197968	HSK-A100	C8	120,0 4.724	91,0 3.583	-	80,0 3.150	-	170,0 6.693	1	1	PB	4,1 9.040
HSKA125-C6-120	03229625	HSK-A125	C6	120,0 4.724	91,0 3.583	-	63,0 2.480	-	183,0 7.205	1	1	PB	5,2 11.460
HSKA125-C6-120-V	03229626	HSK-A125	C6	120,0 4.724	91,0 3.583	30,0 1.181	63,0 2.480	108,0 4.252	183,0 7.205	2	1	PB	6,4 14.110
HSKA125-C8-130	03229627	HSK-A125	C8	130,0 5.118	101,0 3.976	-	80,0 3.150	-	193,0 7.598	1	1	PB	6,5 14.330
HSKA125-C8-130-V	03229628	HSK-A125	C8	130,0 5.118	101,0 3.976	30,0 1.181	80,0 3.150	105,0 4.134	193,0 7.598	2	1	PB	7,8 17.200

Introduzione

Foratura

Alesatura



Barenatura

Allegato

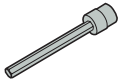
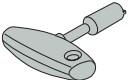
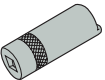
Accessori

Per	Chiave di estensione	Chiave	Chiave
			
HA10-C3-032-080	5680015-05	5680094-06	5680065-13
HA06-C3-032-075	5680015-05	5680094-04	5680065-13
HA10-C4-040-090	5680015-05	5680094-06	5680065-10
HA06-C4-040-080	5680015-05	5680094-04	5680065-10
HA10-C5-050-100	5680015-01	5680094-06	5680065-11
HA06-C5-050-090	5680015-01	5680094-04	5680065-11
HA10-C6-063-110	5680015-02	5680094-06	5680065-12
HA10-C8-080-120	5680015-02	5680094-06	5680065-12
HSKA125-C6-120	5680015-02	5680094-07	5680065-12
HSKA125-C6-120-V	5680015-02	5680094-07	5680065-12
HSKA125-C8-130	5680015-02	5680094-07	5680065-12
HSKA125-C8-130-V	5680015-02	5680094-07	5680065-12

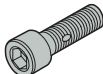
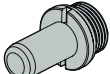
Parti di ricambio, comprese nella fornitura

Per	Vite centrale	Connettore refrigerante	Ghiera di bloccaggio
			
HA06-C3-032-075	5512067-01	5692020-04	5512091-04
HA06-C4-040-080	5512067-02	5692020-04	5512091-03
HA06-C5-050-090	5512067-03	5692020-04	5512091-01
HA10-C3-032-080	5512067-01	5692020-06	5512091-04
HA10-C4-040-090	5512067-02	5692020-06	5512091-03
HA10-C5-050-100	5512067-03	5692020-06	5512091-01
HA10-C6-063-110	5512067-04	5692020-06	5512091-02
HA10-C8-080-120	5512067-04	5692020-06	5512091-02
HSKA125-C6-120	5512063-09	5692020-07	5512091-02
HSKA125-C6-120-V	5512063-09	5692020-07	5512091-02
HSKA125-C8-130	5512063-09	5692020-07	5512091-02
HSKA125-C8-130-V	5512063-09	5692020-07	5512091-02

Accessori / Parti di ricambio

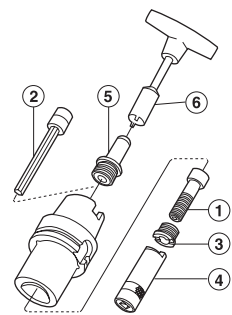

Accessori:
 2 = Chiave di prolunga
 4 = Chiave
 6 = Chiave per il tubo del refrigerante

Ricambi:
 1 = Vite centrale
 3 = Ghiera di fissaggio
 5 = Tubo del refrigerante*

*Uno specifico tubo del refrigerante è fornito con ciascun attacco base HSK-A Seco-Capto™

C 411 – Attacchi da HSK-T a Seco-Capto™ – ISO 26623-2

HSK-T/ ISO12164-3-HSK-T

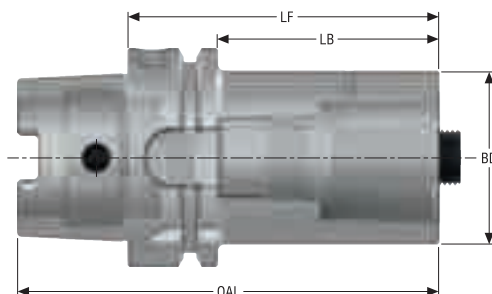

Codice di ordinazione	Codice prodotto	CTMS	CTWS	LF	LB	BD	OAL	Sede RFID	Equilibra- tura	Peso
				mm Inch	mm Inch	mm Inch	mm Inch			kg lb
C4-390.411-63080	02786511	HSK-T63	C4	80,0 3.150	54,0 2.126	40,0 1.575	112,0 4.409	1	-	1,1 2.430
C5-390.411-63090	02786520	HSK-T63	C5	90,0 3.543	64,0 2.520	50,0 1.969	122,0 4.803	1	-	1,5 3.310
C4-390.411-100090	02786519	HSK-T100	C4	90,0 3.543	61,0 2.402	40,0 1.575	140,0 5.512	1	-	2,6 5.730
C5-390.411-100100	02786521	HSK-T100	C5	100,0 3.937	71,0 2.795	50,0 1.969	150,0 5.906	1	-	3,0 6.610
C6-390.411-100110	02786522	HSK-T100	C6	110,0 4.331	81,0 3.189	63,0 2.480	160,0 6.299	1	-	3,6 7.940
C8-390.411-100120	02786523	HSK-T100	C8	120,0 4.724	91,0 3.583	80,0 3.150	170,0 6.693	1	-	4,8 10.580

Accessori

Per	Chiave di estensione	Chiave	Chiave
C4-390.411-63080	5680015-05	5680094-04	5680065-10
C5-390.411-63090	5680015-01	5680094-04	5680065-11
C4-390.411-100090	5680015-05	5680094-06	5680065-10
C5-390.411-100100	5680015-01	5680094-06	5680065-11
C6-390.411-100110	5680015-02	5680094-06	5680065-12
C8-390.411-100120	5680015-02	5680094-06	5680065-12

Parti di ricambio, comprese nella fornitura

Per	Vite centrale	Connettore refrigerante	Ghiera di bloccaggio
C4-390.411-100090	5512063-07	20E9306	5512091-03
C4-390.411-63080	5512063-07	5692020-04	5512091-03
C5-390.411-100100	5512063-08	20E9306	5512091-01
C5-390.411-63090	5512063-08	5692020-04	5512091-01
C6-390.411-100110	5512063-09	5692020-06	5512091-02
C8-390.411-100120	5512063-09	5692020-06	5512091-02

Accessori / Parti di ricambio

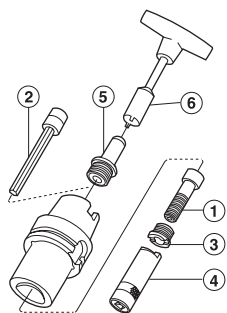

Accessori:

- 2 = Chiave di prolunga
- 4 = Chiave
- 6 = Chiave per il tubo del refrigerante

Ricambi:

- 1 = Vite centrale
- 3 = Ghiera di fissaggio
- 5 = Tubo del refrigerante*

*Uno specifico tubo del refrigerante è fornito con ciascun attacco base HSK-A Seco-Capto™

C 140 – Attacchi da DIN a Seco-Capto™ – ISO 26623-2

DIN 69871-ADB

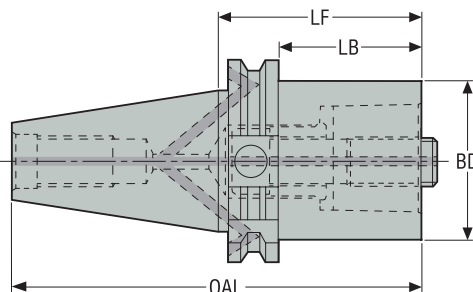

Codice di ordinazione	Codice prodotto	CTMS	CTWS	LF	LB	BD	OAL	Sede RFID	Equilibra- tura	Peso
				mm Inch	mm Inch	mm Inch	mm Inch			
C3-390B.140-40030	02924104	DIN40 ADB	C3	30,0 1.181	10,9 0.429	32,0 1.260	98,4 3.874	0	PB	0,8 1.760
C3-390B.140-40060	02924105	DIN40 ADB	C3	60,0 2.362	40,9 1.610	32,0 1.260	128,4 5.055	0	PB	0,9 1.980
C4-390B.140-40030	02924108	DIN40 ADB	C4	30,0 1.181	10,9 0.429	40,0 1.575	98,4 3.874	0	PB	0,8 1.760
C4-390B.140-40060	02924109	DIN40 ADB	C4	60,0 2.362	40,9 1.610	40,0 1.575	128,4 5.055	0	PB	1,1 2.430
C5-390B.140-40040	02924112	DIN40 ADB	C5	40,0 1.575	20,9 0.823	50,0 1.969	108,4 4.268	0	PB	0,9 1.980
C5-390B.140-40080	02924113	DIN40 ADB	C5	80,0 3.150	60,9 2.398	50,0 1.969	148,4 5.843	0	PB	1,5 3.310
C6-390B.140-40085	02924116	DIN40 ADB	C6	85,0 3.346	65,9 2.594	63,0 2.480	153,4 6.039	0	PB	1,8 3.970
C3-390B.140-50030	02924106	DIN50 ADB	C3	30,0 1.181	10,9 0.429	32,0 1.260	131,7 5.185	0	PB	2,6 5.730
C3-390B.140-50060	02924107	DIN50 ADB	C3	60,0 2.362	40,9 1.610	32,0 1.260	161,7 6.366	0	PB	2,7 5.950
C4-390B.140-50030	02924110	DIN50 ADB	C4	30,0 1.181	10,9 0.429	40,0 1.575	131,7 5.185	0	PB	2,6 5.730
C4-390B.140-50060	02924111	DIN50 ADB	C4	60,0 2.362	40,9 1.610	40,0 1.575	161,7 6.366	0	PB	2,8 6.170
C5-390B.140-50030	02924114	DIN50 ADB	C5	30,0 1.181	10,9 0.429	50,0 1.969	131,7 5.185	0	PB	2,6 5.730
C5-390B.140-50070	02924115	DIN50 ADB	C5	70,0 2.756	50,9 2.004	50,0 1.969	171,7 6.760	0	PB	3,1 6.830
C6-390B.140-50030	02924117	DIN50 ADB	C6	30,0 1.181	10,9 0.429	63,0 2.480	131,7 5.185	0	PB	2,4 5.290
C6-390B.140-50080	02924118	DIN50 ADB	C6	80,0 3.150	60,9 2.398	63,0 2.480	181,7 7.154	0	PB	3,6 7.940
C8-390B.140-50070	02924119	DIN50 ADB	C8	70,0 2.756	50,9 2.004	80,0 3.150	171,7 6.760	0	PB	3,7 8.160
C8-390B.140-50120	02924120	DIN50 ADB	C8	120,0 4.724	100,9 3.972	80,0 3.150	221,7 8.728	0	PB	5,6 12.350

Introduzione

Foratura

Alesatura

Barenatura

Allegato

Accessori

Per	Chiave di estensione	Chiave
C3-400	5680015-05	5680065-13
C4-400	5680015-05	5680065-10
C5-400	5680015-01	5680065-11
C6-400	5680015-01	5680065-12
C3-500	5680015-05	5680065-13
C4-500	5680015-05	5680065-10
C5-500	5680015-01	5680065-11
C6-500	5680015-02	5680065-12
C8	5680015-02	5680065-12

Parti di ricambio, comprese nella fornitura

Per	Vite centrale	Grano	Ghiera di bloccaggio
C3-400	5512063-10	564301701	5512091-04
C3-500	5512063-10	564301702	5512091-04
C4-400	5512063-07	564301701	5512091-03
C4-500	5512063-07	564301702	5512091-03
C5-400	5512063-08	564301701	5512091-01
C5-500	5512063-08	564301702	5512091-01
C6-400	5512063-13	564301701	5512091-02
C6-500	5512063-09	564301702	5512091-02
C8	5512063-09	564301702	5512091-02

Accessori / Parti di ricambio

Accessori:
 4 = Chiave di prolunga
 5 = Chiave

Ricambi:
 1 = Vite centrale
 2 = Ghiera di fissaggio
 3 = Grani (spine)

C 5191 – Seco-Capto™, attacchi base – ISO 26623-2

DIN Cono-Flangia-ADB



Disegno 1

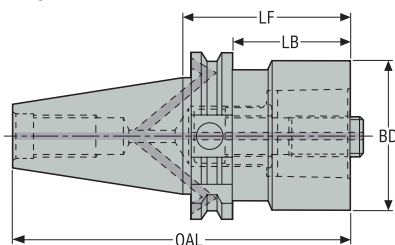

Disegno 2

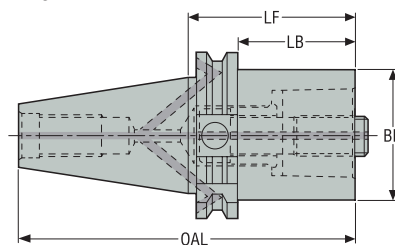

Codice di ordinazione	Codice prodotto	CTMS	CTWS	LF	LB	BD	OAL	Disegno	Sede RFID	Equilibratura	Peso
				mm Inch	mm Inch	mm Inch	mm Inch				kg lb
E316951915050	03030258	DIN40 TF ADB	C5	50,0 1.969	30,9 1.217	50,0 1.969	118,4 4.661	2	1	PB	1,1 2.430
E317151915070	03030264	DIN50 TF ADB	C5	70,0 2.756	50,9 2.004	50,0 1.969	171,7 6.760	2	1	PB	3,1 6.830
E317151916350	03030262	DIN50 TF ADB	C6	50,0 1.969	30,9 1.217	63,0 2.480	151,7 5.972	2	0	-	2,9 6.390
E3171519163100	03030265	DIN50 TF ADB	C6	100,0 3.937	80,9 3.185	63,0 2.480	201,7 7.941	2	1	PB	4,0 8.820
E317151918070	03030263	DIN50 TF ADB	C8	70,0 2.756	50,9 2.004	80,0 3.150	171,7 6.760	2	0	-	3,9 8.600
E3171519180120	03030266	DIN50 TF ADB	C8	120,0 4.724	100,9 3.972	80,0 3.150	221,7 8.728	2	0	-	5,6 12.350

Accessori

Per	Chiave di estensione	Chiave
DIN40 TF/ C5	5680015-01	5680065-11
DIN50 TF/ C5	5680015-01	5680065-11
DIN50 TF/ C6-C8	5680015-02	5680065-12

Parti di ricambio, comprese nella fornitura

Per	Vite centrale	Grano	Ghiera di bloccaggio
DIN40 TF/ C5	5512063-08	564301701	5512091-01
DIN50 TF/ C5	5512063-08	564301702	5512091-01
DIN50 TF/ C6-C8	5512063-09	564301702	5512091-02

Introduzione

Foratura

Alesatura

Barenatura

Allegato

Accessori / Parti di ricambio

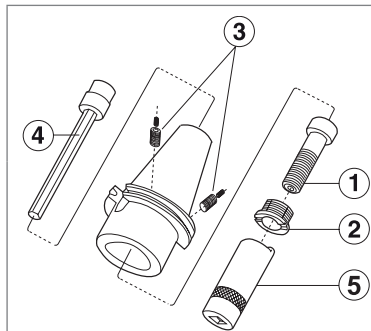

Accessori:
4 = Chiave di prolunga
5 = Chiave

Ricambi:
1 = Vite centrale
2 = Ghiera di fissaggio
3 = Grani (spine)

C 55/58 – Attacchi da BT a Seco-Capto™ – ISO 26623-2

BT



Disegno 1

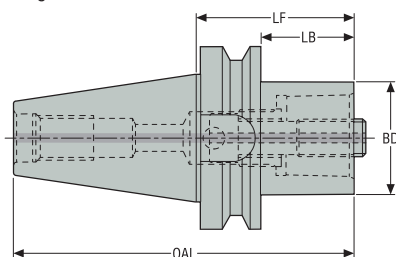

Disegno 2

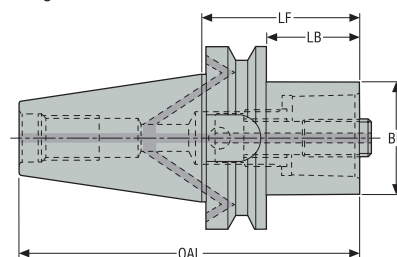

Codice di ordinazione	Codice prodotto	CTMS	CTWS	LF	LB	BD	OAL	Disegno	Sede RFID	Equilibratura	Peso
				mm Inch	mm Inch	mm Inch	mm Inch				kg lb
C3-390.55-30030	75039807	BT30 AD	C3	30,0 1.181	8,0 0.315	32,0 1.260	78,4 3.087	1	0	PB	0,53 1.170
C3-390.55-30060	75039808	BT30 AD	C3	60,0 2.362	38,0 1.496	32,0 1.260	108,4 4.268	1	0	PB	0,73 1.610
C3-390B.55-40030	02925959	BT40 ADB	C3	30,0 1.181	3,0 0.118	32,0 1.260	95,4 3.756	2	0	PB	1,0 2.200
C3-390B.55-40060	02925960	BT40 ADB	C3	60,0 2.362	33,0 1.299	32,0 1.260	125,4 4.937	2	0	PB	1,1 2.430
C4-390B.55-40030	02925963	BT40 ADB	C4	30,0 1.181	3,0 0.118	40,0 1.575	95,4 3.756	2	0	PB	0,9 1.980
C4-390B.55-40060	02925964	BT40 ADB	C4	60,0 2.362	33,0 1.299	40,0 1.575	125,4 4.937	2	0	PB	1,2 2.650
C5-390B.55-40050	02925967	BT40 ADB	C5	50,0 1.969	23,0 0.906	50,0 1.969	115,4 4.543	2	0	PB	1,1 2.430
C5-390B.55-40090	02925968	BT40 ADB	C5	90,0 3.543	63,0 2.480	50,0 1.969	155,4 6.118	2	0	PB	1,7 3.750
C6-390B.55-40075	02925971	BT40 ADB	C6	75,0 2.953	54,6 2.150	63,0 2.480	140,4 5.528	2	0	PB	1,7 3.750
C3-390B.58-50040	02925961	BT50 ADB	C3	40,0 1.575	2,0 0.079	32,0 1.260	141,8 5.583	2	0	PB	3,5 7.720
C3-390B.58-50070	02925962	BT50 ADB	C3	70,0 2.756	32,0 1.260	32,0 1.260	171,8 6.764	2	0	PB	3,7 8.160
C4-390B.58-50040	02925965	BT50 ADB	C4	40,0 1.575	2,0 0.079	40,0 1.575	141,8 5.583	2	0	PB	3,5 7.720
C4-390B.58-50070	02925966	BT50 ADB	C4	70,0 2.756	32,0 1.260	40,0 1.575	171,8 6.764	2	0	PB	3,8 8.380
C5-390B.58-50040	02925969	BT50 ADB	C5	40,0 1.575	2,0 0.079	50,0 1.969	141,8 5.583	2	0	PB	3,5 7.720
C5-390B.58-50080	02925970	BT50 ADB	C5	80,0 3.150	42,0 1.654	50,0 1.969	181,8 7.157	2	0	PB	3,9 8.600
C6-390B.58-50050	02925972	BT50 ADB	C6	50,0 1.969	12,0 0.472	63,0 2.480	151,8 5.976	2	0	PB	3,4 7.500
C6-390B.58-50100	02925973	BT50 ADB	C6	100,0 3.937	62,0 2.441	63,0 2.480	201,8 7.945	2	0	PB	4,6 10.140
C8-390B.58-50070	02925974	BT50 ADB	C8	70,0 2.756	32,0 1.260	80,0 3.150	171,8 6.764	2	0	PB	4,0 8.820
C8-390B.58-50120	02925975	BT50 ADB	C8	120,0 4.724	82,0 3.228	80,0 3.150	221,8 8.732	2	0	PB	5,9 13.010

Introduzione

Foratura

Alesatura



Barenatura

Allegato

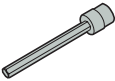
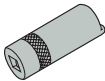
Accessori

Per	Chiave di estensione	Chiave
		
C3-390.55	5680015-05	5680065-13
C3-390B.55	5680015-05	5680065-13
C4-390B.55	5680015-05	5680065-10
C5-390B.55	5680015-01	5680065-11
C6-390B.55	5680015-01	5680065-12
C3-390B.58	5680015-05	5680065-13
C4-390B.58	5680015-05	5680065-10
C5-390B.58	5680015-01	5680065-11
C6-390B.58	5680015-02	5680065-12
C8	5680015-02	5680065-12

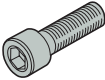
Parti di ricambio, comprese nella fornitura

Per	Vite centrale	Grano	Ghiera di bloccaggio
		 1x	
C3-390.55	5512063-10	-	5512091-04
C3-390B.55	5512063-10	564301701	5512091-04
C3-390B.58	5512063-10	564301702	5512091-04
C4-390B.55	5512063-07	564301701	5512091-03
C4-390B.58	5512063-07	564301702	5512091-03
C5-390B.55	5512063-08	564301701	5512091-01
C5-390B.58	5512063-08	564301702	5512091-01
C6-390B.55	5512063-13	564301701	5512091-02
C6-390B.58	5512063-09	564301702	5512091-02
C8	5512063-09	564301702	5512091-02

Accessori / Parti di ricambio

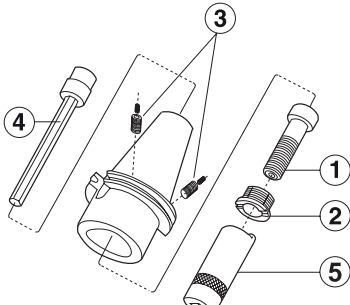

Accessori:
 4 = Chiave di prolunga
 5 = Chiave

Ricambi:
 1 = Vite centrale
 2 = Ghiera di fissaggio
 3 = Grani (spine)

C 605 – Attacchi da BT Mazak a Seco-Capto™ – ISO 26623-2

BT Mazak

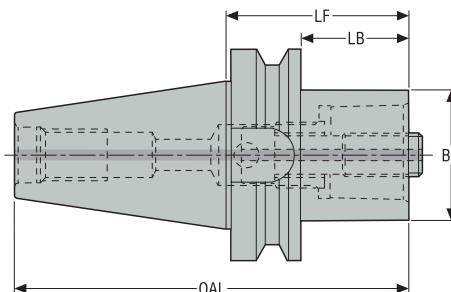

- Design Mazak: connessione Seco-Capto™ ruotata di 90° rispetto agli attacchi base BT classici
- Per e-machines Mazak

Codice di ordinazione	Codice prodotto	CTMS	CTWS	LF	LB	BD	OAL	Sede RFID	Equilibra- tura	Peso
				mm <i>Inch</i>	mm <i>Inch</i>	mm <i>Inch</i>	mm <i>Inch</i>			kg <i>lb</i>
C5-390.605-40030	02606358	BT40 AD Mazak	C5	30,0 1.181	3,0 0.118	50,0 1.969	95,4 3.756	0	-	1,1 2.430
C6-390.605-50040	02606354	BT50 AD Mazak	C6	40,0 1.575	2,0 0.079	63,0 2.480	141,8 5.583	0	-	3,3 7.280
C8-390.605-50070	02646032	BT50 AD Mazak	C8	70,0 2.756	70,0 2.756	80,0 3.150	171,8 6.764	0	-	4,0 8.820

Accessori

Per dimensione	Chiave di estensione	Chiave
C5	5680015-01	5680065-11
C6	5680015-02	5680065-12
C8	5680015-02	5680065-12

Parti di ricambio, comprese nella fornitura

Per dimensione	Vite centrale	Ghiera di bloccaggio
C5	5512063-08	5512091-01
C6	5512063-09	5512091-02
C8	5512063-09	5512091-02

Accessori / Parti di ricambio

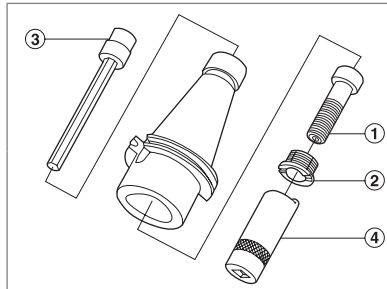

Accessori:
3 = Chiave di prolunga
4 = Chiave

Ricambi:
1 = Vite centrale
2 = Ghiera di fissaggio

C 5191 – Seco-Capto™, attacchi base – ISO 26623-2

BT Cono-Flangia-AD/ADB



Disegno 1

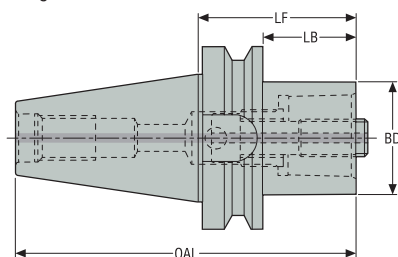

Disegno 2

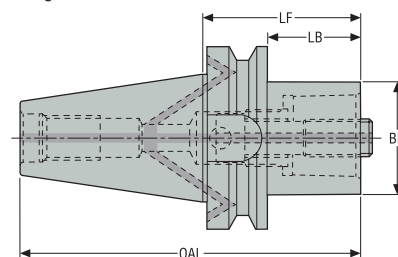



Codice di ordinazione	Codice prodotto	CTMS	CTWS	LF	LB	BD	OAL	Disegno	Sede RFID	Equilibratura	Peso
				mm Inch	mm Inch	mm Inch	mm Inch				kg lb
E400251913240	03030234	BT30 TF AD	C3	40,0 1.575	22,0 0.866	32,0 1.260	88,4 3.480	1	1	PB	0,454 1.000
E400251914060	03030235	BT30 TF AD	C4	60,0 2.362	22,0 0.866	40,0 1.575	108,4 4.268	1	1	PB	0,7 1.540
E311451914040	03030236	BT40 TF ADB	C4	40,0 1.575	13,0 0.512	40,0 1.575	105,4 4.150	2	0	PB	1,1 2.430
E311451915050	03030237	BT40 TF ADB	C5	50,0 1.969	23,0 0.906	50,0 1.969	115,4 4.543	2	0	PB	1,2 2.650
E311451916375	03030238	BT40 TF ADB	C6	75,0 2.953	48,0 1.890	63,0 2.480	140,4 5.528	2	0	PB	1,7 3.750
E311651914040	03030239	BT50 TF ADB	C4	40,0 1.575	2,0 0.079	50,0 1.969	141,8 5.583	2	1	PB	3,5 7.720
E311651915040	03030240	BT50 TF ADB	C5	40,0 1.575	2,0 0.079	50,0 1.969	141,8 5.583	2	0	PB	3,4 7.500
E311651916350	03030241	BT50 TF ADB	C6	50,0 1.969	12,0 0.472	63,0 2.480	151,8 5.976	2	0	PB	3,5 7.720
E3116519163100	03030242	BT50 TF ADB	C6	100,0 3.937	62,0 2.441	63,0 2.480	201,8 7.945	2	0	PB	4,8 10.580
E311651918070	03030243	BT50 TF ADB	C8	70,0 2.756	32,0 1.260	80,0 3.150	171,8 6.764	2	0	PB	4,2 9.260
E3116519180120	03030244	BT50 TF ADB	C8	120,0 4.724	82,0 3.228	80,0 3.150	121,8 4.795	2	1	PB	5,9 13.010

Accessori

Per cono/ dimensione	Chiave di estensione	Chiave
BT30 TF/ C3	5680015-05	5680065-13
BT30 TF/ C4	5680015-05	5680065-10
BT40 TF/ C4	5680015-05	5680065-10
BT40 TF/ C5	5680015-01	5680065-11
BT40 TF/ C6	5680015-01	5680065-12
BT50 TF/ C4	5680015-05	5680065-10
BT50 TF/ C5	5680015-01	5680065-11
BT50 TF/ C6-C8	5680015-02	5680065-12

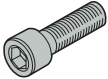
Parti di ricambio, comprese nella fornitura

Per cono/ dimensione	Vite centrale	Grano	Ghiera di bloccaggio
			
BT30 TF/ C3	5512063-10	-	5512091-04
BT30 TF/ C4	5512063-07	-	5512091-03
BT40 TF/ C4	5512063-07	564301701	5512091-03
BT40 TF/ C5	5512063-08	564301701	5512091-01
BT40 TF/ C6	5512063-13	564301701	5512091-02
BT50 TF/ C4	5512063-07	564301702	5512091-03
BT50 TF/ C5	5512063-08	564301702	5512091-01
BT50 TF/ C6-C8	5512063-09	564301702	5512091-02

Accessori / Parti di ricambio

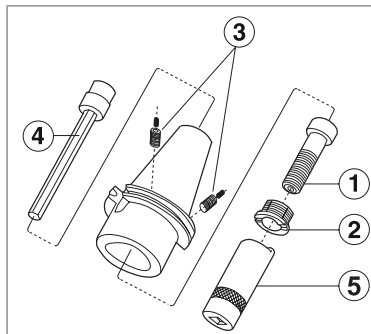

Accessori:
4 = Chiave di prolunga
5 = Chiave

Ricambi:
1 = Vite centrale
2 = Ghiera di fissaggio
3 = Grani (spine)

C 5191 – Seco-Capto™, attacchi base

CAT TF / ASME B5.50-1994-ADB

Introduzione

Foratura

Alesatura

Barenatura

Allegato



Disegno 1

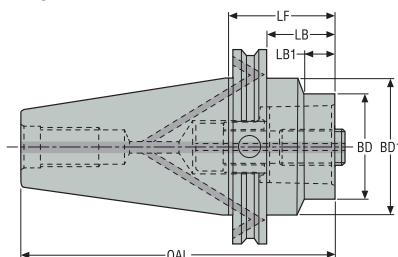

Disegno 2

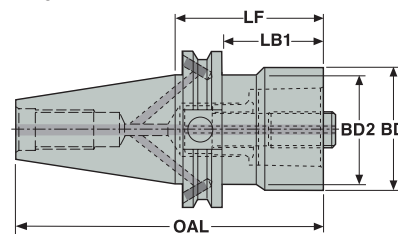

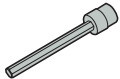
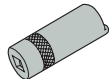

Codice di ordinazione	Codice prodotto	CTMS	CTWS	LF	LB	LB1	BD	BD1	OAL	Disegno	Sede RFID	Equilibratura	Peso
				Inch	Inch	Inch	Inch	Inch	Inch				lb
E234251915050	03030247	CAT40 TF ADB	C5	1.969	1.220	1.220	1.969	1.750	4.660	2	1	PB	2.250
E234451914040	03030249	CAT50 TF ADB	C4	1.575	0.090	0.090	1.575	2.750	5.580	1	1	PB	6.830
E234451915040	03030250	CAT50 TF ADB	C5	1.575	0.090	0.090	1.969	2.750	5.580	1	0	-	6.610
E234451916340	03030251	CAT50 TF ADB	C6	1.575	0.120	0.120	2.480	2.750	5.580	1	0	-	6.170
E234451916390	03030252	CAT50 TF ADB	C6	3.543	2.085	2.085	2.480	2.750	7.543	1	0	-	8.600
E2344519180100	03030253	CAT50 TF ADB	C8	3.937	3.185	3.185	3.150	2.750	7.937	2	1	PB	10.140

Accessori

Per cono/dimensione	Chiave di estensione	Chiave
CAT40/ C5	 5680015-01	 5680065-11
CAT50/ C4	5680015-05	5680065-10
CAT50/ C5	5680015-01	5680065-11
CAT50/ C6	5680015-02	5680065-12
CAT50/ C8	5680015-02	5680065-12

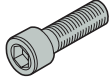
Parti di ricambio, comprese nella fornitura

Per cono/dimensione	Vite centrale	Grano	Ghiera di bloccaggio
CAT40/ C5	 5512063-08	 564301701	 5512091-01
CAT50/ C4	5512063-07	564301702	5512091-03
CAT50/ C5	5512063-08	564301702	5512091-01
CAT50/ C6	5512063-09	564301702	5512091-02
CAT50/ C8	5512063-09	564301702	5512091-02

Accessori / Parti di ricambio

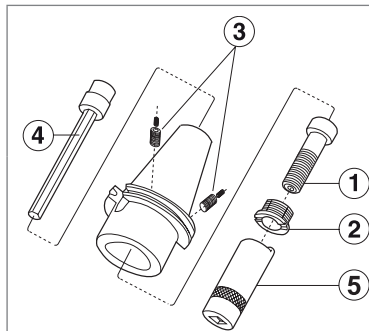

Accessori:
4 = Chiave di prolunga
5 = Chiave

Ricambi:
1 = Vite centrale
2 = Ghiera di fissaggio
3 = Grani (spine)

C 5191 – Seco-Capto™, attacchi base

E-machine CAT TF Mazak™ e Mori Seiki NT™ -Series



Disegno 1

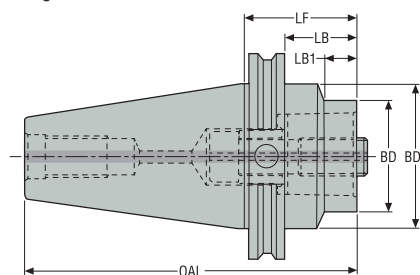

- Poligono ruotato di 90° per un controllo preciso della punta dell'utensile

Codice di ordinazione	Codice prodotto	CTMS	CTWS	LF	LB	LB1	BD	BD1	OAL	Disegno	Sede RFID	Equilibratura	Peso
				Inch	Inch	Inch	Inch	Inch	Inch				lb
E947451916350	03030255	CAT50 TF AD Mazak	C6	1.969	0.510	0.510	2.480	2.750	5.960	1	0	PB	6.830

Accessori

Per dimensione	Chiave di estensione	Chiave
E947451916350	5680015-02	5680065-12

Parti di ricambio, comprese nella fornitura

Per dimensione	Vite centrale	Ghiera di bloccaggio
E947451916350	5512063-09	5512091-02

Accessori / Parti di ricambio

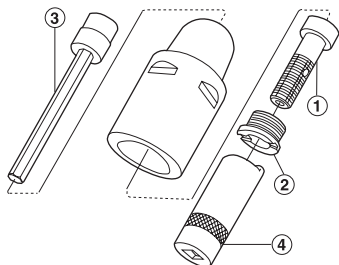

Accessori:
3 = Chiave di prolunga
4 = Chiave per ghiera di fissaggio

Ricambi:
1 = Vite centrale
2 = Ghiera di fissaggio

C 01 – Seco-Capto™, prolunghe

ISO 26623-1

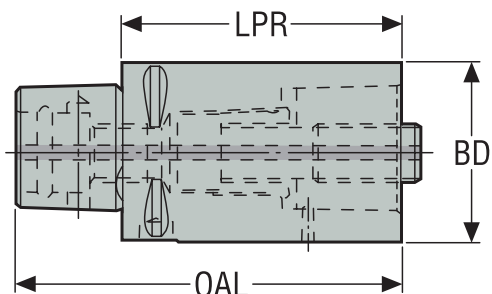

Codice di ordinazione	Codice prodotto	CTMS	CTWS	LPR	BD	OAL	Sede RFID	Equilibra- tura	Peso
				mm Inch	mm Inch	mm Inch			kg lb
C3-391.01-32060A	75039884	C3	C3	60,0 2.362	32,0 1.260	79,0 3.110	0	-	0,4 0.880
C3-391.01-32080A	00090847	C3	C3	80,0 3.150	32,0 1.260	99,0 3.898	0	-	0,5 1.100
C4-391.01-40060A	75039885	C4	C4	60,0 2.362	40,0 1.575	84,0 3.307	0	-	0,6 1.320
C4-391.01-40080A	02207391	C4	C4	80,0 3.150	40,0 1.575	104,0 4.094	0	-	0,71 1.570
C5-391.01-50080A	75039886	C5	C5	80,0 3.150	50,0 1.969	110,0 4.331	0	-	1,1 2.430
C5-391.01-50100A	00004773	C5	C5	100,0 3.937	50,0 1.969	130,0 5.118	0	-	1,39 3.060
C6-391.01-63100A	75039887	C6	C6	100,0 3.937	63,0 2.480	138,0 5.433	0	-	2,2 4.850
C6-391.01-63140A	00004840	C6	C6	140,0 5.512	63,0 2.480	178,0 7.008	0	-	3,2 7.050
C8-391.01-80100A	75039888	C8	C8	100,0 3.937	80,0 3.150	148,0 5.827	0	-	3,6 7.940
C8-391.01-80125A	00004841	C8	C8	125,0 4.921	80,0 3.150	173,0 6.811	0	-	4,7 10.360

Accessori

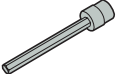
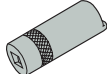
Per dimensione	Chiave di estensione	Chiave
C3	 5680015-05	 5680065-13
C4	5680015-05	5680065-10
C5	5680015-01	5680065-11
C6	5680015-02	5680065-12
C8	5680015-02	5680065-12

Parti di ricambio, comprese nella fornitura

Per dimensione	Vite centrale	Ghiera di bloccaggio
C3	5512067-01	5512091-04
C4	5512067-02	5512091-03
C5	5512067-03	5512091-01
C6	5512067-04	5512091-02
C8	5512067-04	5512091-02

Accessori / Parti di ricambio

Accessori:
3 = Chiave di prolunga
4 = Chiave per ghiera di fissaggio

Ricambi:
1 = Vite centrale
2 = Ghiera di fissaggio

Introduzione

Foratura

Alesatura

Barenatura

Allegato

C 02 – Seco-Capto™ Riduzioni

ISO 26623-1

Disegno 1

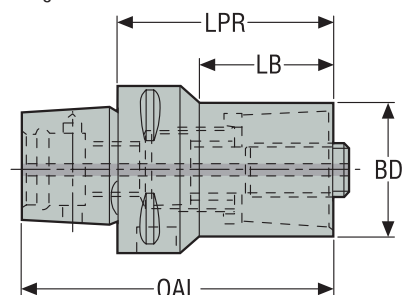

Disegno 2

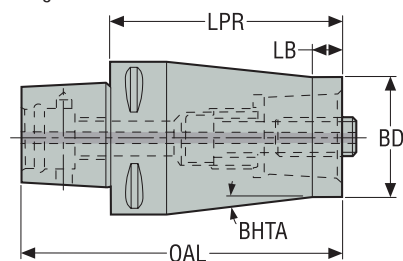

Codice di ordinazione	Codice prodotto	CTMS	CTWS	LPR	LB	BD	OAL	Disegno	BHTA*	Sede RFID	Equilibratura	Peso
				mm Inch	mm Inch	mm Inch	mm Inch					
C4-391.02-32055A	75039889	C4	C3	55,0 2.165	31,0 1.220	32,0 1.260	79,0 3.110	1	-	0	-	0,42 0.930
C4-391.02-32070A	02535687	C4	C3	70,0 2.756	-	32,0 1.260	94,0 3.701	2	6,0	0	-	0,56 1.230
C5-391.02-32060A	75039890	C5	C3	60,0 2.362	34,8 1.370	32,0 1.260	90,0 3.543	1	-	0	-	0,7 1.540
C5-391.02-40065A	75039891	C5	C4	65,0 2.559	40,0 1.575	40,0 1.575	95,0 3.740	1	-	0	-	0,8 1.760
C6-391.02-32070A	75039892	C6	C3	70,0 2.756	39,0 1.535	32,0 1.260	108,0 4.252	1	-	0	-	1,1 2.430
C6-391.02-40080A	75039893	C6	C4	80,0 3.150	51,4 2.024	40,0 1.575	118,0 4.646	1	-	0	-	1,2 2.650
C6-391.02-50080A	75039894	C6	C5	80,0 3.150	51,5 2.028	50,0 1.969	118,0 4.646	1	-	0	-	1,5 3.310
C6-391.02-50110A	02207400	C6	C5	110,0 4.331	12,0 0.472	50,0 1.969	148,0 5.827	2	4,5	0	-	2,2 4.850
C8-391.02-32060B	03080008	C8	C3	60,0 2.362	20,7 0.815	32,0 1.260	108,0 4.252	1	-	0	-	2,0 4.410
C8-391.02-40070B	03080009	C8	C4	70,0 2.756	31,4 1.236	40,0 1.575	118,0 4.646	1	-	0	-	2,1 4.630
C8-391.02-50080B	03080011	C8	C5	80,0 3.150	42,8 1.685	50,0 1.969	128,0 5.039	1	-	0	-	2,4 5.290
C8-391.02-63080B	02527212	C8	C6	80,0 3.150	44,5 1.752	63,0 2.480	128,0 5.039	1	-	0	-	2,6 5.730
C8-391.02-63120A	02207176	C8	C6	120,0 4.724	12,0 0.472	63,0 2.480	168,0 6.614	2	6,0	0	-	4,1 9.040

Accessori

Per dimensione	Chiave di estensione	Chiave
C...-32	 5680015-05	 5680065-13
C...-40	5680015-05	5680065-10
C...-50	5680015-01	5680065-11
C...-63	5680015-02	5680065-12

Introduzione

Foratura

Alesatura

Barenatura

Allegato

Parti di ricambio, comprese nella fornitura

Per dimensione	Vite centrale	Ghiera di bloccaggio
C...32	5512067-01	5512091-04
C...40	5512067-02	5512091-03
C...50	5512067-03	5512091-01
C...63	5512067-04	5512091-02

Accessori / Parti di ricambio

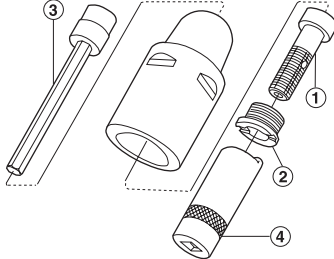

Accessori:
3 = Chiave di prolunga
4 = Chiave per ghiera di fissaggio

Ricambi:
1 = Vite centrale
2 = Ghiera di fissaggio

C01 Prolunghe Seco-Capto™, versione corta, solo per bloccaggio ad espansione radiale

ISO 26623-1

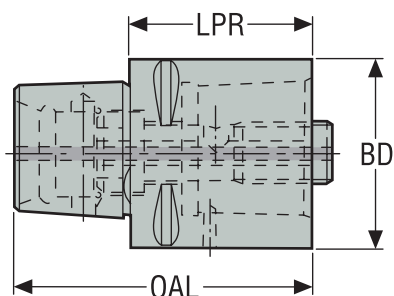

- Le prolunghe Seco-Capto™ versione corta lato macchina possono essere montate solo direttamente su mandrini o torrette Capto con serraggio ad espansione radiale (non con vite centrale)

Codice di ordinazione	Codice prodotto	CTMS	CTWS	LPR	BD	OAL	Sede RFID	Equilibratura	Peso
				mm Inch	mm Inch	mm Inch			kg lb
C3-391.01-32035	02535685	C3	C3	35,0 1.378	32,0 1.260	54,0 2.126	0	-	0,3 0.660
C4-391.01-40040	02535686	C4	C4	40,0 1.575	40,0 1.575	64,0 2.520	0	-	0,4 0.880
C5-391.01-50050	02484934	C5	C5	50,0 1.969	50,0 1.969	80,0 3.150	0	-	0,7 1.540
C6-391.01-63060	02300834	C6	C6	60,0 2.362	63,0 2.480	98,0 3.858	0	-	1,3 2.870
C8-391.01-80065	02417041	C8	C8	65,0 2.559	80,0 3.150	113,0 4.449	0	-	2,4 5.290

Accessori

Per	Chiave di estensione
C3-391.01-32035	5680015-05
C4-391.01-40040	5680015-05
C5-391.01-50050	5680015-05
C6-391.01-63060	5680015-02
C8-391.01-80065	5680015-02

Parti di ricambio, comprese nella fornitura

Per	Vite centrale	Anello Seeger
C3-391.01-32035	5512068-01	5545040-02
C4-391.01-40040	5512068-02	5545040-03
C5-391.01-50050	5512068-03	5545040-07
C6-391.01-63060	5512068-04	5545040-08
C8-391.01-80065	5512068-05	5545040-08

Accessori / Parti di ricambio

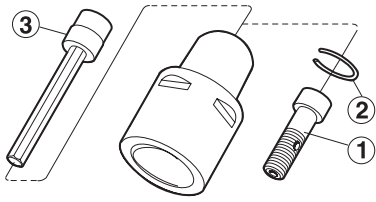

Accessori:
3 = Chiave di prolunga

Ricambi:
1 = Vite centrale
2 = Anelli elastici

Introduzione

Foratura

Alesatura

Barenatura

Allegato

C02 Riduzioni Seco-Capto™, versione corta, solo per bloccaggio ad espansione radiale

ISO 26623-1

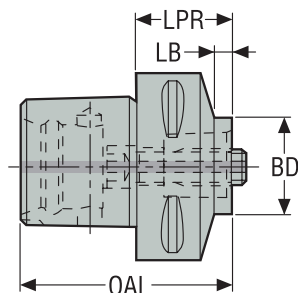

- Le riduzioni Seco-Capto™ versione corta lato macchina possono essere montate solo direttamente su mandrini o torrette Capto con serraggio ad espansione radiale (non con vite centrale)
- * Con offset lato macchina di 180° rispetto al lato pezzo in lavorazione

Codice di ordinazione	Codice prodotto	CTMS	CTWS	LPR	LB	BD	OAL	*	Sede RFID	Equilibra- tura	Peso
				mm Inch	mm Inch	mm Inch	mm Inch				kg lb
C5-391.02-32033A	03080025	C5	C3	33,0 1.299	5,0 0.197	32,0 1.260	63,0 2.480	-	0	PB	0,6 1.320
C5-391.02-40040A	03079983	C5	C4	40,0 1.575	15,0 0.591	40,0 1.575	70,0 2.756	-	0	-	0,6 1.320
C6-391.02-32032	02535690	C6	C3	32,0 1.260	6,0 0.236	32,0 1.260	70,0 2.756	-	0	-	0,85 1.870
C6-391.02-40040	02459467	C6	C4	40,0 1.575	11,0 0.433	40,0 1.575	78,0 3.071	-	0	-	0,9 1.980
C6-391.02-50050A	03080019	C6	C5	50,0 1.969	20,0 0.787	50,0 1.969	88,0 3.465	-	0	-	1,1 2.430
C8-391.02-50045A	03080010	C8	C5	45,0 1.772	5,0 0.197	50,0 1.969	93,0 3.661	-	0	-	2,0 4.410
C8-391.02-63055A	03080012	C8	C6	55,0 2.165	15,0 0.591	63,0 2.480	103,0 4.055	-	0	-	2,1 4.630
C8-391.02R-63055A	03080030	C8	C6	55,0 2.165	15,0 0.591	63,0 2.480	103,0 4.055	*	0	-	1,9 4.190

Accessori

Per	Chiave di estensione
C5-391.02-32033A	5680015-05
C5-391.02-40040A	5680015-05
C6-391.02-32032	5680015-05
C6-391.02-40040	5680015-05
C6-391.02-50050A	5680015-01
C8-391.02-50045A	5680015-01
C8-391.02-63055A	5680015-02
C8-391.02R-63055A	5680015-02

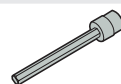

Parti di ricambio, comprese nella fornitura

Per	Vite centrale	Anello Seeger
C5-391.02-32033A	5512068-01	5545040-02
C5-391.02-40040A	5512068-06	5545040-07
C6-391.02-32032	5512068-01	5545040-02
C6-391.02-40040	5512068-02	5545040-03
C6-391.02-50050A	5512068-07	5545040-08
C8-391.02-50045A	5512068-08	5545040-08
C8-391.02-63055A	5512068-05	5545040-08
C8-391.02R-63055A	5512068-05	5545040-08

Accessori / Parti di ricambio

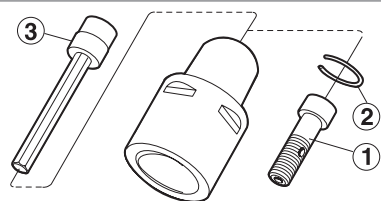

Accessori:
3 = Chiave di prolunga

Ricambi:
1 = Vite centrale
2 = Anelli elastici

GL – Barre Steadyline® HSK-T/A GL

Diametri 25, 32, 40 e 50 mm / 0.984, 1.260, 1.575 e 1.969 pollici

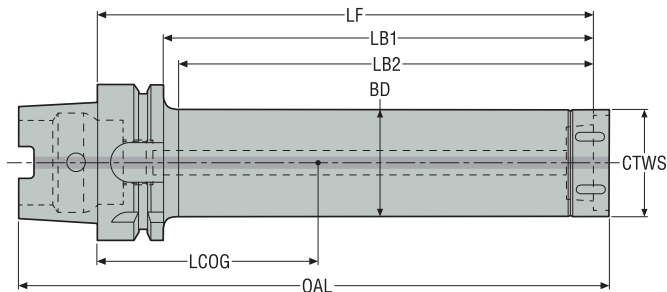

- Con smorzamento delle vibrazioni
- Con adduzione refrigerante interna
- * Max. num. di giri/min solo in barenatura rotante

Codice di ordinazione	Codice prodotto	CTMS HSK-T/A	CTWS Dimensione GL	BD	LF	LB1	LB2	OAL	LCOG	Max. num. di giri*	Sede RFID	Equilibratura	Peso
				mm inch	mm inch	mm inch	mm inch	mm inch	mm inch				
HSKTA63-GL25-130-K	03214283	HSK-T/A63	GL25	25,0 0.984	130,0 5.118	104,0 4.094	101,0 3.976	166,5 6.555	37,0 1.457	0	1	PB	1,4 3.090
HSKTA63-GL25-180-K	03214284	HSK-T/A63	GL25	25,0 0.984	180,0 7.087	154,0 6.063	151,0 5.945	216,5 8.524	57,7 2.272	0	1	PB	1,5 3.310
HSKTA63-GL25-230-K	03214285	HSK-T/A63	GL25	25,0 0.984	230,0 9.055	204,0 8.031	201,0 7.913	266,5 10.492	80,3 3.161	0	1	PB	1,5 3.310
E9374-D32-160-GL32	03029521	HSK-T/A63	GL32	32,0 1.260	160,0 6.299	134,0 5.276	128,0 5.039	197,4 7.772	58,92 2.320	0	1	PB	1,6 3.530
E9374-D32-224-GL32	03029522	HSK-T/A63	GL32	32,0 1.260	224,0 8.819	198,0 7.795	192,0 7.559	261,4 10.291	90,22 3.552	0	1	PB	2,0 4.410
E9374-D40-208-GL40	03029523	HSK-T/A63	GL40	40,0 1.575	208,0 8.189	182,0 7.165	176,0 6.929	246,4 9.701	92,78 3.653	0	1	PB	2,7 5.950
E9374-D40-288-GL40	03029524	HSK-T/A63	GL40	40,0 1.575	288,0 11.339	262,0 10.315	256,0 10.079	326,4 12.850	134,37 5.290	0	1	PB	3,5 7.720
E9374-D50-268-GL50	03029525	HSK-T/A63	GL50	50,0 1.969	268,0 10.551	242,0 9.528	240,5 9.469	307,4 12.102	131,8 5.189	0	1	PB	4,8 10.580
E9374-D50-368-GL50	03029526	HSK-T/A63	GL50	50,0 1.969	368,0 14.488	342,0 13.465	340,5 13.406	407,4 16.039	184,79 7.275	0	1	PB	6,4 14.110
E9376-D32-160-GL32	03029527	HSK-T/A100	GL32	32,0 1.260	160,0 6.299	131,0 5.157	125,0 4.921	215,4 8.480	32,87 1.294	0	1	PB	3,0 6.610
E9376-D32-224-GL32	03029528	HSK-T/A100	GL32	32,0 1.260	224,0 8.819	195,0 7.677	189,0 7.441	279,4 11.000	54,97 2.164	0	1	PB	3,4 7.500
E9376-D32-288-GL32	03029529	HSK-T/A100	GL32	32,0 1.260	288,0 11.339	259,0 10.197	253,0 9.961	343,4 13.520	80,51 3.170	0	1	PB	3,8 8.380
E9376-D40-208-GL40	03029530	HSK-T/A100	GL40	40,0 1.575	208,0 8.189	179,0 7.047	173,0 6.811	264,4 10.409	62,83 2.474	0	1	PB	4,1 9.040
E9376-D40-288-GL40	03029531	HSK-T/A100	GL40	40,0 1.575	288,0 11.339	259,0 10.197	253,0 9.961	344,4 13.559	98,31 3.870	0	1	PB	4,9 10.800
E9376-D40-368-GL40	03029532	HSK-T/A100	GL40	40,0 1.575	368,0 14.488	339,0 13.346	333,0 13.110	424,4 16.709	139,77 5.503	0	1	PB	5,8 12.790
E9376-D50-268-GL50	03029533	HSK-T/A100	GL50	50,0 1.969	268,0 10.551	239,0 9.409	234,0 9.213	325,4 12.811	104,26 4.105	0	1	PB	6,2 13.670
E9376-D50-368-GL50	03029534	HSK-T/A100	GL50	50,0 1.969	368,0 14.488	339,0 13.346	334,0 13.150	425,4 16.748	154,26 6.073	0	1	PB	7,8 17.200
E9376-D50-468-GL50	03029535	HSK-T/A100	GL50	50,0 1.969	468,0 18.425	439,0 17.283	434,0 17.087	525,4 20.685	211,61 8.331	0	1	PB	9,7 21.380

Introduzione

Foratura

Alesatura

Barenatura

Allegato

Accessori

Per dimensione	Terminale sostituibile	Chiave dinamometrica
GL25	-	-
GL32	SL00-32	SL00-32.250
GL40	SL00-40	SL00-40.350
GL50	SL00-50	SL00-50.550

Parti di ricambio, comprese nella fornitura

Per dimensione	Chiave di bloccaggio
GL25	SL25
GL32	SL32
GL40	SL40
GL50	SL50

Introduzione

Foratura

Alesatura

Barenatura

Allegato

BA – Steadyline®, barre HSK T/A- attacchi BA

Diametri 60 e 80 mm / 2.362 e 3.150 pollici

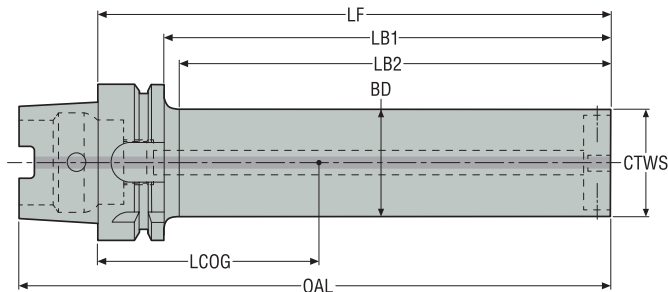

- Con smorzamento delle vibrazioni
- Per montare unità GL attraverso specifici adattatori da BA a GL
- Con adduzione refrigerante interna
- * Max. num. di giri/min solo in barenatura rotante

Codice di ordinazione	Codice prodotto	CTMS Dimensione HSK-T/A	CTWS BA connection	BD	LF	LB1	LB2	OAL	LCOG	Max. num. di giri*	Sede RFID	Equilibra- tura	Peso
				mm inch	mm inch	mm inch	mm inch	mm inch	mm inch				
E9376-D60-301-BA060	03062828	HSK-T/A100	BA060	60,0 2.362	301,0 11.850	272,0 10.709	267,0 10.512	351,0 13.819	133,05 5.238	4000	1	PB	8,9 19.620
E9376-D60-421-BA060	03062829	HSK-T/A100	BA060	60,0 2.362	421,0 16.575	392,0 15.433	387,0 15.236	471,0 18.543	197,17 7.763	0	1	PB	11,8 26.010
E9376-D60-541-BA060	03062830	HSK-T/A100	BA060	60,0 2.362	541,0 21.299	512,0 20.157	507,0 19.961	591,0 23.268	260,56 10.258	0	1	PB	14,5 31.970
E9376-D80-421-BA080	03064109	HSK-T/A100	BA080	80,0 3.150	421,0 16.575	392,0 15.433	387,0 15.236	471,0 18.543	209,68 8.255	0	1	PB	19,4 42.770
E9376-D80-581-BA080	03064111	HSK-T/A100	BA080	80,0 3.150	581,0 22.874	552,0 21.732	547,0 21.535	631,0 24.843	295,45 11.632	0	1	PB	26,2 57.760

Accessori

Per dimensione

Chiave di bloccaggio



BA060

03H04

BA080

03H05

Parti di ricambio, comprese nella fornitura

Per dimensione

Vite di bloccaggio



BA060

90FQ4

BA080

90FQ52

Barre Steadyline® GL

Diametri 25, 32, 40 e 50 mm / 0.984, 1.260, 1.575 e 1.969 pollici

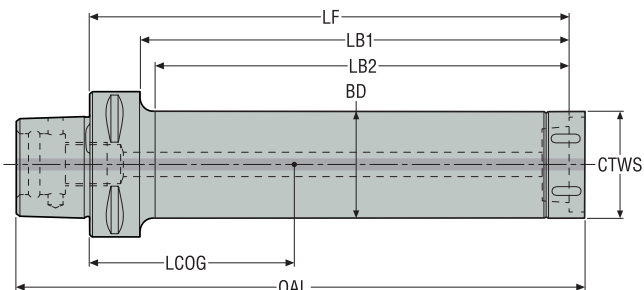

- Con smorzamento delle vibrazioni
- Con adduzione refrigerante interna
- * Max. num. di giri/min solo in barenatura rotante

Codice di ordinazione	Codice prodotto	CTMS Dimensione Seco-Capto™	CTWS Dimensione GL	BD	LF	LB1	LB2	OAL	LCOG	Max. num. di giri*	Sede RFID	Equilibra- tura	Peso
				mm inch	mm inch	mm inch	mm inch	mm inch	mm inch				mm inch
C4-D25-130-GL25	03214272	C4	GL25	25,0 0.984	130,0 5.118	110,0 4.331	107,0 4.213	158,5 6.240	51,8 2.039	0	0	PB	1,0 2.200
C4-D25-180-GL25	03214273	C4	GL25	25,0 0.984	180,0 7.087	160,0 6.299	157,0 6.181	208,5 8.209	77,2 3.039	0	0	PB	1,2 2.650
C4-D32-160-GL32	02807837	C4	GL32	32,0 1.260	160,0 6.299	140,0 5.512	137,0 5.394	189,4 7.457	74,73 2.942	0	0	PB	1,4 3.090
C4-D32-224-GL32	02807838	C4	GL32	32,0 1.260	224,0 8.819	204,0 8.031	201,0 7.913	253,4 9.976	109,16 4.298	0	0	PB	1,7 3.750
C5-D25-130-GL25	03214274	C5	GL25	25,0 0.984	130,0 5.118	110,0 4.331	107,0 4.213	164,5 6.476	41,8 1.646	0	1	PB	1,1 2.430
C5-D25-180-GL25	03214275	C5	GL25	25,0 0.984	180,0 7.087	160,0 6.299	157,0 6.181	214,5 8.445	65,1 2.563	0	1	PB	1,3 2.870
C5-D25-230-GL25	03214276	C5	GL25	25,0 0.984	230,0 9.055	210,0 8.268	207,0 8.150	264,5 10.413	89,8 3.535	0	1	PB	1,5 3.310
C5-D32-160-GL32	02807840	C5	GL32	32,0 1.260	160,0 6.299	140,0 5.512	136,0 5.354	195,4 7.693	65,15 2.565	0	1	PB	1,6 3.530
C5-D32-224-GL32	02807841	C5	GL32	32,0 1.260	224,0 8.819	204,0 8.031	200,0 7.874	259,4 10.213	98,47 3.877	0	1	PB	2,0 4.410
C5-D32-288-GL32	02807842	C5	GL32	32,0 1.260	288,0 11.339	268,0 10.551	264,0 10.394	323,4 12.732	133,61 5.260	0	1	PB	2,2 4.850
C5-D40-208-GL40	02807843	C5	GL40	40,0 1.575	208,0 8.189	188,0 7.402	184,0 7.244	244,4 9.622	98,32 3.871	0	1	PB	2,8 6.170
C5-D40-288-GL40	02807844	C5	GL40	40,0 1.575	288,0 11.339	268,0 10.551	264,0 10.394	324,4 12.772	140,88 5.546	0	1	PB	3,3 7.280
C6-D25-130-GL25	03214277	C6	GL25	25,0 0.984	130,0 5.118	105,0 4.134	102,0 4.016	172,5 6.791	30,4 1.197	0	1	PB	1,6 3.530
C6-D25-180-GL25	03214278	C6	GL25	25,0 0.984	180,0 7.087	155,0 6.102	152,0 5.984	222,5 8.760	49,3 1.941	0	1	PB	1,5 3.310
C6-D25-230-GL25	03214279	C6	GL25	25,0 0.984	230,0 9.055	205,0 8.071	202,0 7.953	272,5 10.728	70,2 2.764	0	1	PB	1,7 3.750
C6-D32-160-GL32	02807846	C6	GL32	32,0 1.260	160,0 6.299	135,0 5.315	129,0 5.079	203,4 8.008	52,06 2.050	0	1	PB	1,8 3.970
C6-D32-224-GL32	02807847	C6	GL32	32,0 1.260	224,0 8.819	199,0 7.835	193,0 7.598	267,4 10.528	82,17 3.235	0	1	PB	2,2 4.850
C6-D32-288-GL32	02807848	C6	GL32	32,0 1.260	288,0 11.339	263,0 10.354	257,0 10.118	331,4 13.047	114,87 4.522	0	1	PB	2,6 5.730
C6-D40-208-GL40	02807849	C6	GL40	40,0 1.575	208,0 8.189	183,0 7.205	177,0 6.969	252,4 9.937	86,42 3.402	0	1	PB	2,9 6.390

Codice di ordinazione	Codice prodotto	CTMS Dimensione Seco-Capto™	CTWS Dimensione GL	BD	LF	LB1	LB2	OAL	LCOG	Max. num. di giri*	Sede RFID	Equilibra- tura	Peso
				mm inch	mm inch	mm inch	mm inch	mm inch	mm inch				
C6-D40-288-GL40	02807850	C6	GL40	40,0 1.575	288,0 11.339	263,0 10.354	257,0 10.118	332,4 13.087	127,5 5.020	0	1	PB	3,7 8.160
C6-D40-368-GL40	02807851	C6	GL40	40,0 1.575	368,0 14.488	343,0 13.504	337,0 13.268	412,4 16.236	173,14 6.817	0	1	PB	4,6 10.140
C6-D50-268-GL50	02807852	C6	GL50	50,0 1.969	268,0 10.551	243,0 9.567	238,0 9.370	313,4 12.339	126,6 4.984	0	1	PB	5,4 11.900
C6-D50-368-GL50	02807853	C6	GL50	50,0 1.969	368,0 14.488	343,0 13.504	338,0 13.307	413,4 16.276	179,44 7.065	0	1	PB	6,6 14.550
C6-D50-468-GL50	02807854	C6	GL50	50,0 1.969	468,0 18.425	443,0 17.441	438,0 17.244	513,4 20.213	238,49 9.389	0	1	PB	8,5 18.740
C8-D32-224-GL32	03029356	C8	GL32	32,0 1.260	224,0 8.819	191,0 7.520	181,0 7.126	277,5 10.925	58,17 2.290	0	1	PB	3,2 7.050
C8-D32-288-GL32	03029357	C8	GL32	32,0 1.260	288,0 11.339	255,0 10.039	245,0 9.646	341,5 13.445	84,7 3.335	0	1	PB	3,6 7.940
C8-D40-288-GL40	03029358	C8	GL40	40,0 1.575	288,0 11.339	255,0 10.039	245,0 9.646	341,5 13.445	102,14 4.021	0	1	PB	4,7 10.360
C8-D40-368-GL40	03029359	C8	GL40	40,0 1.575	368,0 14.488	335,0 13.189	325,0 12.795	422,5 16.634	144,04 5.671	0	1	PB	5,6 12.350
C8-D50-268-GL50	03029360	C8	GL50	50,0 1.969	268,0 10.551	235,0 9.252	225,0 8.858	323,4 12.732	107,59 4.236	0	1	PB	5,9 13.010
C8-D50-368-GL50	03029361	C8	GL50	50,0 1.969	368,0 14.488	335,0 13.189	325,0 12.795	423,4 16.669	158,08 6.224	0	1	PB	7,5 16.530
C8-D50-468-GL50	03029362	C8	GL50	50,0 1.969	468,0 18.425	435,0 17.126	425,0 16.732	523,4 20.606	215,6 8.488	0	1	PB	9,4 20.720

Accessori

Per dimensione	Terminale sostituibile	Chiave dinamometrica
GL25	-	-
GL32	SL00-32	SL00-32.250
GL40	SL00-40	SL00-40.350
GL50	SL00-50	SL00-50.550

Parti di ricambio, comprese nella fornitura

Per dimensione	Chiave di bloccaggio
GL25	SL25
GL32	SL32
GL40	SL40
GL50	SL50

Introduzione

Foratura

Alesatura

Barenatura

Allegato

Barre Steadyline® BA

Diametri 60 e 80 mm / 2.362 e 3.150 pollici

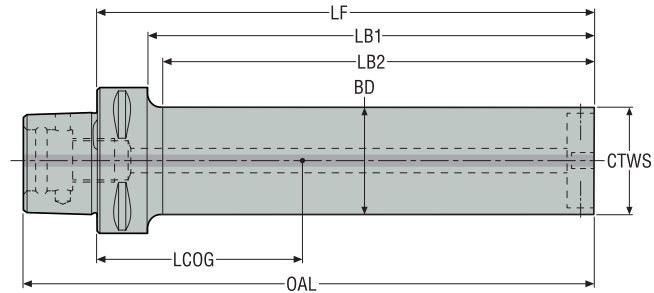

- Con smorzamento delle vibrazioni
- Per montare unità GL attraverso specifici adattatori da BA a GL
- Con addizione refrigerante interna
- * Max. num. di giri/min solo in barenatura rotante

Codice di ordinazione	Codice prodotto	CTMS Dimensione Seco-Capto™	CTWS Dimensione BA	BD	LF	LB1	LB2	OAL	LCOG	Max. num. di giri*	Sede RFID	Equilibratura	Peso
				mm inch	mm inch	mm inch	mm inch	mm inch	mm inch				kg lb
C6-D60-301-BA060	03062831	C6	BA060	60,0 2.362	301,0 11.850	276,0 10.866	273,0 10.748	339,0 13.346	151,74 5.974	4000	1	PB	7,8 17.200
C6-D60-421-BA060	03062832	C6	BA060	60,0 2.362	421,0 16.575	396,0 15.591	393,0 15.472	459,0 18.071	218,63 8.607	3000	1	PB	10,6 23.370
C8-D60-301-BA060	03062833	C8	BA060	60,0 2.362	301,0 11.850	268,0 10.551	263,0 10.354	349,0 13.740	137,04 5.395	4000	1	PB	8,6 18.960
C8-D60-421-BA060	03062834	C8	BA060	60,0 2.362	421,0 16.575	388,0 15.276	383,0 15.079	469,0 18.465	202,5 7.972	3000	1	PB	11,4 25.130
C8-D60-541-BA060	03062835	C8	BA060	60,0 2.362	541,0 21.299	508,0 20.000	503,0 19.803	589,0 23.189	266,78 10.503	2000	1	PB	14,0 30.860
C8-D80-421-BA080	03065829	C8	BA080	80,0 3.150	421,0 16.575	388,0 15.276	383,0 15.079	469,0 18.465	213,89 8.421	3000	1	PB	18,8 41.450
C8-D80-581-BA080	03065830	C8	BA080	80,0 3.150	581,0 22.874	548,0 21.575	543,0 21.378	629,0 24.764	300,38 11.826	2000	1	PB	25,1 55.340

Accessori

Per dimensione	Chiave di bloccaggio
BA060	03H04
BA080	03H05

Parti di ricambio, comprese nella fornitura

Per dimensione	Vite di bloccaggio
BA060	90FQ4
BA080	90FQ52

Introduzione

Foratura

Alesatura

Barenatura

Allegato



Barenatura di sgrossatura

La gamma Seco di prodotti per barenatura di sgrossatura massimizza l'asportazione e la precisione grazie a prestazioni affidabili e altamente rigide. Disponibili sia con impostazione simmetrica che a gradino. Le soluzioni di smorzamento delle vibrazioni Steadyline™ completano la gamma per offrire livelli ancora più elevati di stabilità per la lavorazione di cavità profonde, dove sono necessarie lunghe sporgenze dell'utensile.

- Le testine RB 750 per barenatura di sgrossatura offrono le massime prestazioni in sgrossatura
- Le testine RB 610 per barenatura di sgrossatura sono corte, semplici e robuste, adatte ad operazioni di sgrossatura

Panoramica testine per barenatura di sgrossatura

Introduzione

Foratura

Alesatura

Barenatura

Allegato

Graflex®



Ø 18-24 (Ø 0.709"-0.945")



Ø 23-31 (Ø 0.906"-1.220")



Ø 30-40 (Ø 1.181"-1.575")



Ø 39-51 (Ø 1.535"-2.008")



Ø 50-65 (Ø 1.968"-2.559")



Ø 64-86 (Ø 2.520"-3.386")



Ø 85-144 (Ø 3.346"-5.669")



Ø 114-205
(Ø 4.488"-8.071")

Seco-Capto™



Ø 39-51 (Ø 1.535"-2.008")



Ø 50-65 (Ø 1.968"-2.559")



Ø 64-86 (Ø 2.520"-3.386")



Ø 85-144 (Ø 3.346"-5.669")



Ø 114-205
(Ø 4.488"-8.071")

Barenatura simmetrica:
 2 portainseri standard tipo A

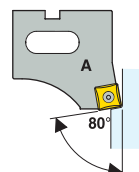
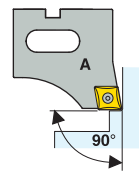
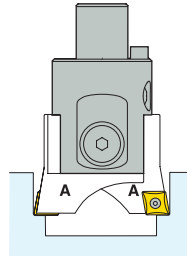

Barenatura a gradino:
 1 portainsero maggiorato tipo B ed 1
 standard tipo A

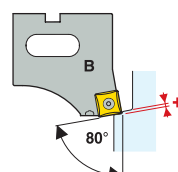
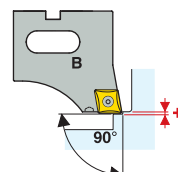
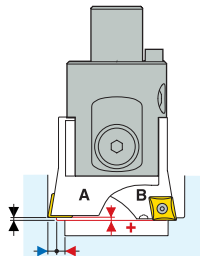

Caratteristiche

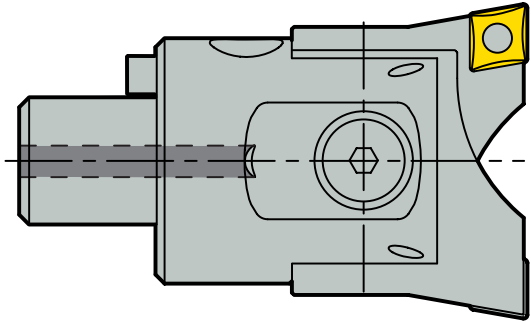
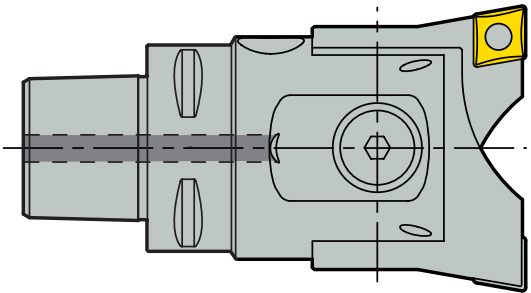
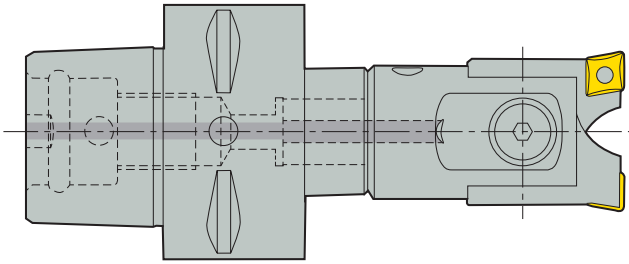
<p>Testine Graflex® per barenatura di sgrossatura</p> <ul style="list-style-type: none"> • Ø da 18 a 205 mm (da 0,709 a 8,071") • 8 testine per barenatura di sgrossatura RB 750 con connessione Graflex® per fori Ø da 18 a 205 mm (da 0,709 a 8,071") 		Introduzione
<p>Testine per barenatura di sgrossatura Seco-Capto™</p> <ul style="list-style-type: none"> • Nota: Le testine per barenatura di sgrossatura Seco-Capto™ possono barenare fori di Ø minimo 39 mm (1,535"), con la più piccola dimensione Capto™ C3. • Per Ø da 18 a 40 mm (0,709-1,575") usare le testine per barenatura Graflex® con dimensione di connessione da G0 a G2, insieme all'appropriato adattatore Capto™/Graflex®. 		Foratura
<p>Testine per barenatura di sgrossatura Seco-Capto™</p> <ul style="list-style-type: none"> • Nota: Caratteristiche, istruzioni (montaggio del portainsero, regolazione del diametro, istruzioni per barenatura in tirata, risoluzione dei problemi, condizioni di lavorazione consigliate, velocità massime), portainseri ed inserti dedicati sono analoghi a quelli delle testine RB 750 di finitura della stessa capacità di barenatura, indipendentemente dal tipo di connessione. • Assiem modulari e condizioni di taglio adattatori ed estensioni modulari Seco-Capto™ e Graflex®: consultare il catalogo Tooling Systems (Sistemi di Utensili). 		Alesatura
		Barenatura
		Allegato

Caratteristiche

Una testina per barenatura di sgrossatura è costituita da 1 corpo (testina) e da 2 portainseri.

Sono possibili regolazioni simultanee o indipendenti dei portainseri:

Regolazione simultanea grazie al meccanismo di accoppiamento dei portainseri (senza meccanismo di accoppiamento per la testina più piccola con \varnothing da 18 a 24 mm [0,709-0,9445]). Ciascuna vite di regolazione fa muovere entrambi i portainseri simultaneamente (sono accoppiati dal meccanismo). La regolazione del diametro può essere effettuata senza alcun elemento di pre-regolazione (1 incremento = 0,1 mm (0,004") sul diametro). È possibile anche la regolazione indipendente: disimpegnare il meccanismo di accoppiamento in modo che ciascuna vite di regolazione agisca solamente sul rispettivo portainsero.

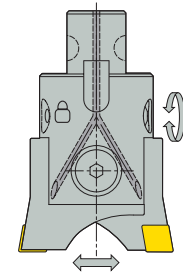

Regolazione simultanea

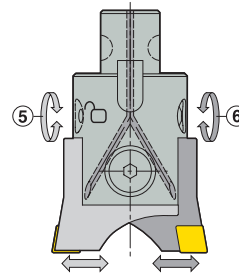

Regolazione indipendente

Barenatura simmetrica:

La barenatura simmetrica si ottiene quando entrambi i taglienti sono regolati sullo stesso diametro: richiede due portainseri standard di tipo A (aventi identico angolo di attacco).

Barenatura a gradino:

La barenatura a gradino si ottiene quando un tagliente sfalsato opera come tagliente di imbocco su un diametro minore rispetto ad un secondo tagliente regolato sul diametro da ottenere: necessita di un portainsero standard di tipo A e di un portainsero maggiorato di tipo B che consente lo sfalsamento assiale richiesto (+).

Portainseri per angolo di attacco 90° o 80°

I portainseri A75...CC... e A75...CP... per inserti romboidali hanno un angolo di attacco di 90°: sono particolarmente adatti ai fori ciechi e richiedono una coppia inferiore. I portainseri A75...SC... per inserti quadrati hanno un angolo di attacco di 80°: sono particolarmente adatti per i fori passanti e per le lavorazioni pesanti. Orientamento angolare dei taglienti come da normative ISO.

Portainseri per inserti CC, CP, SC o CN

I portainseri A750...CC..., A750...CP... e A750...SC... hanno angolo di spoglia di 0° (GAMO) ed angolo di inclinazione di 0° (LAMS).

I portainseri A750...CN... hanno angolo di spoglia di -6° (GAMO) ed angolo di inclinazione di -6° (LAMS) e consentono l'uso di inserti "negativi" CNMM e soprattutto di inserti multi-taglienti CNMG con 4 taglienti.

In questo caso, è particolarmente importante utilizzare gli inserti CN raccomandati ed utilizzare i parametri di taglio consigliati (vedere pagina 682).

Con altri inserti aventi angolo di taglio effettivo inferiore e/o parametri di taglio errati, ci potrebbero essere sforzi di taglio elevati e danneggiamenti alla macchina o al pezzo in lavoro.

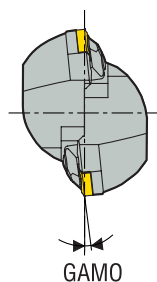

GAMO

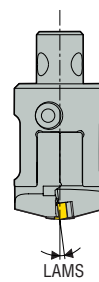

LAMS

Introduzione

Foratura

Alesatura

Barenatura

Allegato

RB750

Graflex®

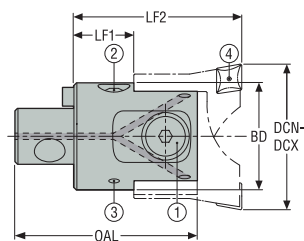

1. Vite di assemblaggio
2. Vite di regolazione
3. Vite di bloccaggio del meccanismo di accoppiamento
4. Vite di bloccaggio inserto

- Sono possibili la barenatura simmetrica e quella a gradino
- Regolazione simultanea mediante meccanismo di accoppiamento dei portainseri

Codice di ordinazione	Codice prodotto	Lato macchina Dimensione Graflex	Lato utensile Capacità DCN-DCX Ø		OAL	LF1	LF2	BD	Peso	Modalità di regolazione simultanea		Modalità di regolazione indipendente		Max. num. di giri
			mm Inch	mm Inch						Si	No	Si	No	
A75000	00026687	G0	18,0 0.709	24,0 0.945	38,0 1.496	12,5 0.492	35,0 1.378	16,5 0.650	0,1 0.220		■	■		15000
A75010	00026688	G1	23,0 0.906	31,0 1.220	42,5 1.673	13,5 0.531	40,0 1.575	21,5 0.846	0,1 0.220	■		■		12000
A75020	00026689	G2	30,0 1.181	40,0 1.575	51,0 2.008	16,0 0.630	46,0 1.811	27,0 1.063	0,2 0.440	■		■		9500
A75030	00026690	G3	39,0 1.535	51,0 2.008	69,0 2.717	24,0 0.945	65,0 2.559	35,0 1.378	0,3 0.660	■		■		7500
A75040	00026691	G4	50,0 1.969	65,0 2.559	78,0 3.071	27,0 1.063	72,0 2.835	43,0 1.693	0,6 1.320	■		■		5700
A75050	00026692	G5	64,0 2.520	86,0 3.386	92,0 3.622	30,0 1.181	82,0 3.228	54,0 2.126	0,9 1.980	■		■		4500
A75060	00026693	G6	85,0 3.346	144,0 5.669	119,0 4.685	37,0 1.457	105,0 4.134	70,0 2.756	1,8 3.970	■		■		3500
A75070	00026694	G7	114,0 4.488	205,0 8.071	143,0 5.630	39,0 1.535	120,0 4.724	95,0 3.740	3,7 8.160	■		■		2500

I portainseri devono essere ordinati a parte, vedere le pagine 592-596
Nota: Il peso è senza portainsero

Parti di ricambio, comprese nella fornitura

Per testa	Vite di assemblaggio	Tenone
A75000	90A75000	90M0
A75010	90A75010	90M11
A75020	90A75020	90M21
A75030	90A75030	90M31
A75040	90A75040	90M41
A75050	90A75050	90M51
A75060	90A75060	90M61
A75070	90A75070	90M71

Introduzione

Foratura

Alesatura

Barenatura

Allegato

Accessori

Per testa	Chiave per vite staffa	Chiavetta di trascinamento	Chiave per vite inserto	Chiave (impugnatura a T)	Chiave di regolazione
A75000	03HL03	-	H4B-T07P	DOUBLE-T	H1.5-2D
A75010	03HL03	H4B-T06P	H4B-T07P	DOUBLE-T	H1.5-2D
A75020	03HL04	H4B-T07P	-	DOUBLE-T	H2.0-2D
A75030	03HL05	H4B-T08P	-	DOUBLE-T	H2.0-2D
A75040	03HL05	H4B-T09P	-	DOUBLE-T	H2.5-2D
A75050	03HL06	-	-	DOUBLE-T	03M03C
A75060	03HL08	-	-	DOUBLE-T	-
A75070	03HL10	H4B-T15P	H4B-T15PL	DOUBLE-T	-

Introduzione

Foratura

Alesatura

Barenatura

Allegato

RB750

Seco-Capto™

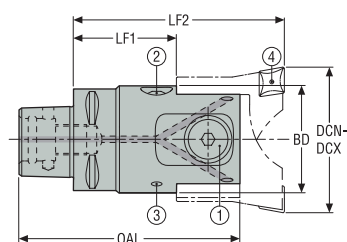

1. Vite di assemblaggio
2. Vite di regolazione
3. Vite di bloccaggio del meccanismo di accoppiamento
4. Vite di bloccaggio inserto



- Sono possibili la barenatura simmetrica e quella a gradino
- Regolazione simultanea mediante meccanismo di accoppiamento dei portainseri

Codice di ordinazione	Codice prodotto	Lato macchina	Lato utensile		OAL	LF1	LF2	BD	Peso	Modalità di regolazione simultanea		Modalità di regolazione indipendente		Max. num. di giri
			Capacità	DCN-DCX Ø						Si	No	Si	No	
C3-391.0750-30	02809726	C3	39,0 1.535	51,0 2.008	73,0 2.874	29,0 1.142	70,0 2.756	35,0 1.378	0,3 0.660	■		■		7500
C4-391.0750-40	02809728	C4	50,0 1.969	65,0 2.559	88,0 3.465	37,0 1.457	82,0 3.228	43,0 1.693	0,6 1.320	■		■		5700
C5-391.0750-50	02809733	C5	64,0 2.520	86,0 3.386	102,0 4.016	40,0 1.575	92,0 3.622	54,0 2.126	1,1 2.430	■		■		4500
C6-391.0750-60	02809735	C6	85,0 3.346	144,0 5.669	129,0 5.079	49,0 1.929	117,0 4.606	70,0 2.756	1,9 4.190	■		■		3500
C8-391.0750-70	02809736	C8	114,0 4.488	205,0 8.071	159,0 6.260	57,0 2.244	138,0 5.433	95,0 3.740	4,1 9.040	■		■		2500



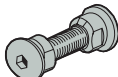

I portainseri devono essere ordinati a parte, vedere le pagine 592-596

Nota: Il peso è senza portainsero

Parti di ricambio, comprese nella fornitura

Per testa	Vite di assemblaggio
	
C3-...-30	90A75030
C4-...-40	90A75040
C5-...-50	90A75050
C6-...-60	90A75060
C8-...-70	90A75070

Accessori

Per testa	Chiave per vite staffa	Chiavetta di trascinamento	Chiave (impugnatura a T)	Chiave di regolazione
				
C3-...-30	03HL05	H4B-T08P	DOUBLE-T	H2.0-2D
C4-...-40	03HL05	H4B-T09P	DOUBLE-T	H2.5-2D
C5-...-50	03HL06	-	DOUBLE-T	03M03C
C6-...-60	03HL08	-	DOUBLE-T	-
C8-...-70	03HL10	-	DOUBLE-T	-

Portainsero a 90° per inserti CC.. e CP..

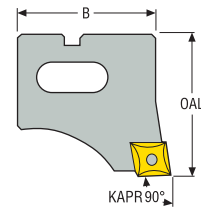

- Per il montaggio sulle teste RB 750
- La barenatura simmetrica richiede due portainseri standard di tipo A.
- La barenatura a gradino richiede un portainseri standard di tipo A e uno esteso di tipo B

Codice di ordinazione	Codice prodotto	Tipologia portainsero	Per testa	Capacità DCN-DCX Ø		OAL	B	Peso	KRINS°	Dimensione inserto
				mm Inch	mm Inch					
A7500CP0590	00026695	Standard tipo A	RB 75000	18,0 0.709	24,0 0.945	22,5 0.886	16,5 0.650	0,1 0.220	90	CP...0502...
A75010CC0690	00026696	Standard tipo A	RB 75010	23,0 0.906	31,0 1.220	26,5 1.043	21,5 0.846	0,1 0.220	90	CC...0602...
A75020CC0690	00026697	Standard tipo A	RB 75020	30,0 1.181	40,0 1.575	30,0 1.181	27,0 1.063	0,04 0.090	90	CC...0602...
A75030CC0990	00026698	Standard tipo A	RB 75030	39,0 1.535	51,0 2.008	41,0 1.614	35,0 1.378	0,1 0.220	90	CC...09T3...
A75040CC1290	00026699	Standard tipo A	RB 75040	50,0 1.969	65,0 2.559	45,0 1.772	43,0 1.693	0,2 0.440	90	CC...1204...
A75050CC1290	00026700	Standard tipo A	RB 75050	64,0 2.520	86,0 3.386	52,0 2.047	54,0 2.126	0,3 0.660	90	CC...1204...
A75060CC1290	00026701	Standard tipo A	RB 75060	85,0 3.346	115,0 4.528	68,0 2.677	70,0 2.756	0,6 1.320	90	CC...1204...
A75060CC1690	00030763	Standard tipo A	RB 75060	85,0 3.346	115,0 4.528	68,0 2.677	70,0 2.756	0,6 1.320	90	CC...1605...
A75065CC1290	00026702	Standard tipo A	RB 75060	114,0 4.488	144,0 5.669	68,0 2.677	100,0 3.937	0,9 1.980	90	CC...1204...
A75065CC1690	00030765	Standard tipo A	RB 75060	114,0 4.488	144,0 5.669	68,0 2.677	100,0 3.937	0,9 1.980	90	CC...1605...
A75070CC1290	00026703	Standard tipo A	RB 75070	114,0 4.488	160,0 6.299	81,0 3.189	95,0 3.740	1,3 2.870	90	CC...1204...
A75070CC1690	00030766	Standard tipo A	RB 75070	114,0 4.488	160,0 6.299	81,0 3.189	95,0 3.740	1,2 2.650	90	CC...1605...
A75075CC1290	00026704	Standard tipo A	RB 75070	159,0 6.260	205,0 8.071	81,0 3.189	141,0 5.551	2,0 4.410	90	CC...1204...
A75075CC1690	00030771	Standard tipo A	RB 75070	159,0 6.260	205,0 8.071	81,0 3.189	141,0 5.551	2,0 4.410	90	CC...1605...

Parti di ricambio, comprese nella fornitura

Per dimensione inserto	Chiave per vite inserto	Chiave (impugnatura a T)	Vite
CP...0502...	H4B-T07P	DOUBLE-T	C02245-T07P
CC...0602...	H4B-T07P	DOUBLE-T	C02504-T07P
CC...09T3...	H4B-T15P	DOUBLE-T	C04008-T15P
CC...1204...	H4B-T15P	DOUBLE-T	C05012-T15P
CC...1605...	H4B-T15P	DOUBLE-T	C05012-T15P

Per gli inserti consigliati per la barenatura di sgrossatura, vedere le pagine 682

Portainsero a 90° per inserti CC.. e CP..

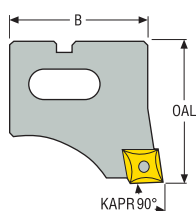

- Per il montaggio sulle teste RB 750
- La barenatura simmetrica richiede due portainseri standard di tipo A.
- La barenatura a gradino richiede un portainseri standard di tipo A e uno esteso di tipo B

Codice di ordinazione	Codice prodotto	Tipologia portainsero	Per testa	Capacità DCN-DCX Ø		OAL	B	Peso	KRINS°	Dimensione inserto
				mm Inch	mm Inch					
A75001CP0590	00026705	Maggiorato tipo B	RB 75000	18,0 0.709	24,0 0.945	22,8 0.898	16,5 0.650	0,1 0.220	90	CP...0502...
A75011CC0690	00026706	Maggiorato tipo B	RB 75010	23,0 0.906	31,0 1.220	26,85 1.057	21,5 0.846	0,1 0.220	90	CC...0602...
A75021CC0690	00026707	Maggiorato tipo B	RB 75020	30,0 1.181	40,0 1.575	30,35 1.195	27,0 1.063	0,1 0.220	90	CC...0602...
A75031CC0990	00026708	Maggiorato tipo B	RB 75030	39,0 1.535	51,0 2.008	41,4 1.630	35,0 1.378	0,1 0.220	90	CC...09T3...
A75041CC1290	00026709	Maggiorato tipo B	RB 75040	50,0 1.969	65,0 2.559	46,5 1.831	43,0 1.693	0,2 0.440	90	CC...1204...
A75051CC1290	00026710	Maggiorato tipo B	RB 75050	64,0 2.520	86,0 3.386	52,6 2.071	54,0 2.126	0,25 0.550	90	CC...1204...
A75061CC1290	00026711	Maggiorato tipo B	RB 75060	85,0 3.346	115,0 4.528	68,6 2.701	70,0 2.756	0,55 1.210	90	CC...1204...
A75061CC1690	00030774	Maggiorato tipo B	RB 75060	85,0 3.346	115,0 4.528	68,6 2.701	70,0 2.756	0,6 1.320	90	CC...1605...
A75066CC1290	00026712	Maggiorato tipo B	RB 75060	114,0 4.488	144,0 5.669	68,6 2.701	100,0 3.937	1,0 2.200	90	CC...1204...
A75066CC1690	00030775	Maggiorato tipo B	RB 75060	114,0 4.488	144,0 5.669	68,6 2.701	100,0 3.937	0,91 2.070	90	CC...1605...
A75071CC1290	00026713	Maggiorato tipo B	RB 75070	114,0 4.488	160,0 6.299	81,6 3.213	95,0 3.740	1,2 2.650	90	CC...1204...
A75071CC1690	00030776	Maggiorato tipo B	RB 75070	114,0 4.488	160,0 6.299	81,6 3.213	95,0 3.740	1,16 2.560	90	CC...1605...
A75076CC1290	00026714	Maggiorato tipo B	RB 75070	159,0 6.260	205,0 8.071	81,6 3.213	141,0 5.551	2,0 4.470	90	CC...1204...
A75076CC1690	00030778	Maggiorato tipo B	RB 75070	159,0 6.260	205,0 8.071	81,6 3.213	141,0 5.551	0,9 1.980	90	CC...1605...

Parti di ricambio, comprese nella fornitura

Per dimensione inserto	Chiave (impugnatura a T)	Chiave	Vite
CP...0502...	DOUBLE-T	H4B-T07P	C02245-T07P
CC...0602...	DOUBLE-T	H4B-T07P	C02504-T07P
CC...09T3...	DOUBLE-T	H6B-T15P	C04008-T15P
CC...1204...	DOUBLE-T	H6B-T15P	C05012-T15P
CC...1605...	DOUBLE-T	H6B-T15P	C05012-T15P

Per gli inserti consigliati per la barenatura di sgrossatura, vedere le pagine 682

Portainsero a 80° per inserti SC..

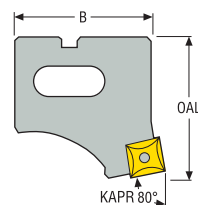



- Per il montaggio sulle teste RB 750
- La barenatura simmetrica richiede due portainseri standard di tipo A.
- La barenatura a gradino richiede un portainseri standard di tipo A e uno esteso di tipo B

Codice di ordinazione	Codice prodotto	Tipologia portainsero	Per testa	Capacità DCN-DCX Ø		OAL	B	Peso	KRINS°	Dimensione inserto
				mm	mm					
A75000SC0580	00026715	Standard tipo A	RB 75000	18,0 0.709	24,0 0.945	22,5 0.886	16,5 0.650	0,1 0.220	80	SC...0502...
A75010SC0680	00026716	Standard tipo A	RB 75010	23,0 0.906	31,0 1.220	26,5 1.043	21,5 0.846	0,1 0.220	80	SC...0602...
A75020SC0680	00026717	Standard tipo A	RB 75020	30,0 1.181	40,0 1.575	30,0 1.181	27,0 1.063	0,1 0.220	80	SC...0602...
A75030SC0980	00026718	Standard tipo A	RB 75030	39,0 1.535	51,0 2.008	41,0 1.614	35,0 1.378	0,1 0.220	80	SC...09T3...
A75040SC1280	00026719	Standard tipo A	RB 75040	50,0 1.969	65,0 2.559	45,0 1.772	43,0 1.693	0,2 0.440	80	SC...1204...
A75050SC1280	00051986	Standard tipo A	RB 75050	64,0 2.520	86,0 3.386	52,0 2.047	54,0 2.126	0,25 0.550	80	SC...1204...
A75060SC1280	00052207	Standard tipo A	RB 75060	85,0 3.346	115,0 4.528	68,0 2.677	70,0 2.756	0,56 1.230	80	SC...1204...
A75060SC1580	00039863	Standard tipo A	RB 75060	85,0 3.346	115,0 4.528	68,0 2.677	70,0 2.756	0,56 1.230	80	SC...1505...
A75065SC1280	00051989	Standard tipo A	RB 75060	114,0 4.488	144,0 5.669	68,0 2.677	100,0 3.937	1,0 2.200	80	SC...1204...
A75065SC1580	00039865	Standard tipo A	RB 75060	114,0 4.488	144,0 5.669	68,0 2.677	100,0 3.937	1,0 2.200	80	SC...1505...
A75070SC1280	00026723	Standard tipo A	RB 75070	114,0 4.488	160,0 6.299	81,4 3.205	95,0 3.740	1,2 2.650	80	SC...1204...
A75070SC1580	00039867	Standard tipo A	RB 75070	114,0 4.488	160,0 6.299	81,4 3.205	95,0 3.740	1,18 2.600	80	SC...1505...
A75075SC1280	00026724	Standard tipo A	RB 75070	159,0 6.260	205,0 8.071	81,4 3.205	141,0 5.551	2,2 4.850	80	SC...1204...
A75075SC1580	00039869	Standard tipo A	RB 75070	159,0 6.260	205,0 8.071	81,4 3.205	141,0 5.551	2,1 4.630	80	SC...1505...
A75001SC0580	00092946	Maggiorato tipo B	RB 75000	18,0 0.709	24,0 0.945	23,2 0.913	16,5 0.650	0,01 0.020	80	SC...0502...
A75011SC0680	00092947	Maggiorato tipo B	RB 75010	23,0 0.906	31,0 1.220	27,3 1.075	21,5 0.846	0,02 0.040	80	SC...0602...
A75021SC0680	00092948	Maggiorato tipo B	RB 75020	30,0 1.181	40,0 1.575	30,9 1.217	27,0 1.063	0,04 0.090	80	SC...0602...
A75031SC0980	00092949	Maggiorato tipo B	RB 75030	39,0 1.535	51,0 2.008	42,2 1.661	35,0 1.378	0,08 0.180	80	SC...09T3...
A75041SC1280	00092961	Maggiorato tipo B	RB 75040	50,0 1.969	65,0 2.559	46,4 1.827	43,0 1.693	0,2 0.440	80	SC...1204...
A75051SC1280	00092962	Maggiorato tipo B	RB 75050	64,0 2.520	86,0 3.386	53,7 2.114	54,0 2.126	0,3 0.660	80	SC...1204...
A75061SC1580	00039864	Maggiorato tipo B	RB 75060	85,0 3.346	115,0 4.528	70,3 2.768	70,0 2.756	0,57 1.260	80	SC...1505...
A75061SC1280	00092963	Maggiorato tipo B	RB 75060	85,0 3.346	115,0 4.528	69,8 2.748	70,0 2.756	0,57 1.260	80	SC...1204...

Codice di ordinazione	Codice prodotto	Tipologia portainserito	Per testa	Capacità DCN-DCX Ø		OAL	B	Peso	KRINS°	Dimensione inserto
				mm Inch	mm Inch	mm Inch	mm Inch	kg lb		
A75066SC1280	00092964	Maggiorato tipo B	RB 75060	114,0 4.488	144,0 5.669	69,8 2.748	100,0 3.937	0,96 2.120	80	SC...1204...
A75066SC1580	00039866	Maggiorato tipo B	RB 75060	114,0 4.488	144,0 5.669	70,3 2.768	100,0 3.937	0,96 2.120	80	SC...1505...
A75071SC1280	00092965	Maggiorato tipo B	RB 75070	114,0 4.488	160,0 6.299	82,8 3.260	95,0 3.740	1,2 2.650	80	SC...1204...
A75071SC1580	00039868	Maggiorato tipo B	RB 75070	114,0 4.488	160,0 6.299	83,3 3.280	95,0 3.740	1,21 2.670	80	SC...1505...
A75076SC1280	00092968	Maggiorato tipo B	RB 75070	159,0 6.260	205,0 8.071	82,8 3.260	141,0 5.551	2,16 4.760	80	SC...1204...
A75076SC1580	00039870	Maggiorato tipo B	RB 75070	159,0 6.260	205,0 8.071	83,3 3.280	141,0 5.551	2,14 4.720	80	SC...1505...

Parti di ricambio, comprese nella fornitura

Per dimensione inserto	Chiave (impugnatura a T)	Chiave	Vite
			
SC...0502...	DOUBLE-T	H4B-T07P	C02245-T07P
SC...0602...	DOUBLE-T	H4B-T07P	C02504-T07P
SC...09T3...	DOUBLE-T	-	C04008-T15P
SC...1204...	DOUBLE-T	H6B-T15P	C05012-T15P
SC...1505...	DOUBLE-T	H6B-T15P	C05012-T15P
SC...09T3...	DOUBLE-T	H6B-T15P	C04008-T15P
SC...1204...	DOUBLE-T	H6B-T15PL	C05012-T15P

Per gli inserti consigliati per la barenatura di sgrossatura, vedere le pagine 682

Portainsero a 90° per inserti CN..

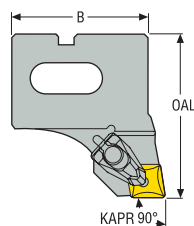

- Per il montaggio sulle teste RB 750
- La barenatura simmetrica richiede due portainseri standard di tipo A (portainseri estesi di tipo B per inserti CN.. non disponibili)
- GAMO = Angolo di spoglia = - 6°
- LAMS = Angolo di inclinazione = - 6°

Codice di ordinazione	Codice prodotto	Tipologia portainsero	Per testa	Capacità DCN-DCX Ø		OAL	B	Peso	KRINS°	Dimensione inserto
				mm <i>Inch</i>	mm <i>Inch</i>					
A75050CN1290	02786307	Standard tipo A	RB 75050	64,0 2.520	86,0 3.386	63,0 2.480	55,0 2.165	0,4 0.880	90	CN...1204...
A75060CN1290	02786308	Standard tipo A	RB 75060	85,0 3.346	115,0 4.528	68,0 2.677	69,5 2.736	0,6 1.320	90	CN...1204...
A75065CN1290	02786309	Standard tipo A	RB 75060	114,0 4.488	144,0 5.669	68,0 2.677	99,5 3.917	0,9 1.980	90	CN...1204...
A75070CN1290	02786310	Standard tipo A	RB 75070	114,0 4.488	160,0 6.299	85,0 3.346	95,0 3.740	1,2 2.650	90	CN...1204...
A75075CN1290	02786311	Standard tipo A	RB 75070	159,0 6.260	205,0 8.071	85,0 3.346	140,0 5.512	2,03 4.480	90	CN...1204...

Parti di ricambio, comprese nella fornitura

Per dimensione inserto	Vite per supporto	Kit di bloccaggio	Supporto inserto	Chiave
CN...1204...	 CSC6312-T15P	 CD12-S12	 UCN120612	 H6B-T15P

Per gli inserti consigliati per la barenatura di sgrossatura, vedere le pagine 682

Istruzioni Condizioni di lavorazione consigliate

Potenza mandrino:

Poiché la barenatura di sgrossatura richiede l'impiego di macchine ad alta potenza, raccomandiamo di verificare che la macchina sia idonea. La barenatura a gradino è una soluzione per ridurre le esigenze di potenza, poiché l'avanzamento è dimezzato a parità di profondità totale di taglio, rispetto all'impostazione simmetrica.

Le migliori prestazioni si ottengono utilizzando lubrorefrigerante (parametri di lavorazione più elevati, migliore finitura superficiale, migliore evacuazione dei trucioli, maggiore durata dell'inserito).

Per istruzioni dettagliate, fare riferimento alle istruzioni operative fornite con le testine per barenatura e con le barre Steadyline®.

Le istruzioni operative possono anche essere scaricate da www.secotools.com.

Velocità massime per teste per barenatura di sgrossatura

Testa	Capacità Ø mm	Capacità Ø pollici	Max. num. di giri	Velocità di taglio massima consigliata v_c alla cap. min. m/min (sf/min)	Velocità di taglio massima consigliata v_c alla cap. max. m/min (sf/min)
Teste per barenatura di sgrossatura (con due portainseriti identici regolati simmetricamente), con connessione Graflex®					
A75000	18-24	0.709-0.945	15000	848 (2782)	1131 (3711)
A75010	23-31	0.906-1.220	12000	867 (2844)	1169 (3835)
A75020	30-40	1.181-1.575	9500	895 (2936)	1194 (3917)
A75030	39-51	1.535-2.008	7500	919 (3015)	1202 (3944)
A75040	50-65	1.969-2.559	5700	895 (2936)	1164 (3819)
A75050	64-86	2.520-3.386	4500	905 (2969)	1216 (3990)
A75060	85-115	3.346-4.528	3500	935 (3068)	1264 (4147)
A75060	114-144	4.488-5.669	2700	967 (3173)	1221 (4006)
A75070	114-160	4.488-6.299	2500	895 (2936)	1257 (4124)
A75070	159-205	6.260-8.071	2000	999 (3278)	1288 (4226)
Teste per barenatura di sgrossatura (con due portainseriti identici regolati simmetricamente), con connessione Seco-Capto™					
C3-391.0750-30	39-51	1.535-2.008	7500	919 (3015)	1202 (3944)
C4-391.0750-40	50-65	1.969-2.559	5700	895 (2936)	1164 (3819)
C5-391.0750-50	64-86	2.520-3.386	4500	905 (2969)	1216 (3990)
C6-391.0750-60	85-115	3.346-4.528	3500	935 (3068)	1264 (4147)
C6-391.0750-60	114-144	4.488-5.669	2700	967 (3173)	1221 (4006)
C8-391.0750-70	114-160	4.488-6.299	2500	895 (2936)	1257 (4124)
C8-391.0750-70	159-205	6.260-8.071	2000	999 (3278)	1288 (4226)

Nota: Le velocità massime dipendono dalla struttura meccanica delle teste di barenatura e dalla qualità di equilibratura. Le velocità massime sono correlate alla struttura meccanica della testa di barenatura e alla qualità di equilibratura. Le velocità all'interno di questi limiti devono essere scelte in funzione delle altre condizioni di lavorazione, esempio materiale del pezzo da lavorare, tagliente (inserito), lunghezza utensile, mandrino macchina. Alle velocità di circa 8000 giri/min e superiori i portainseriti di base e le prolungheriduttori devono essere accuratamente equilibrati.

Istruzioni per la risoluzione dei problemi

Problema	Possibile causa	Soluzione
Cattivo controllo truciolo	Velocità di avanzamento troppo bassa	Aumentare l'avanzamento
	Eccessiva profondità di taglio	Utilizzare il metodo a gradino
Vibrazioni	Velocità troppo elevata	Ridurre la velocità ma non l'avanzamento Accorciare l'utensile per aumentarne la rigidità
	Rapporto L/D eccessivo	Aumentare il diametro esterno dell'albero e degli intermedi di tenuta
		Utilizzare una barra Steadyline
	Utilizzare prolunghe in metallo duro o in metallo pesante	
	Raggio dell'inserto troppo ampio	Utilizzare un inserto con raggio inferiore
	Pezzo da lavorare instabile	Migliorare stabilità e staffaggio
	L'angolo di attacco k è di 80°	Cambiare a $k = 90^\circ$, inserto di tipo CC
Scheggiatura o rottura dell'inserto	Inserto non adatto	Utilizzare un inserto di qualità più tenace Utilizzare un raggio più ampio, se disponibile
	Taglio fortemente interrotto	Ridurre la velocità e l'avanzamento
	Accumulo di trucioli e ripetizione del taglio	Controllare lo spazio tra barra di barenatura e diametro foro Migliorare il controllo del truciolo, aumentare l'avanzamento
Scarsa durata utensile	Inserto non adatto	Utilizzare una qualità più resistente all'usura
	Velocità di taglio troppo elevata	Ridurre la velocità
	Scheggiatura inserto	Controllare profondità di taglio e velocità di avanzamento
	Pressione del refrigerante troppo bassa	Aumentare la pressione del refrigerante
Cattiva evacuazione truciolo	Diametro dell'assemblato troppo grande	Utilizzare una testina più piccola con prolunga, se possibile
	Eccessiva profondità di taglio	Utilizzare il metodo a gradino; preferire inserti CC.. rispetto ad inserti CN.. (in particolare quando si usa la testina per barenatura ai suoi diametri più piccoli).
	Spazio inadeguato dietro al foro	Collocare il pezzo in una posizione più alta sulla tavola
	Cattivo controllo truciolo	Vedere sopra
Potenza macchina insufficiente	Avanzamento eccessivo	Ridurre l'avanzamento (non meno del 25% del raggio inserto)
	Eccessiva profondità di taglio	Utilizzare il metodo a gradino
	Bassa potenza della macchina	Giri/min nell'area con bassa coppia mandrino: aumentare la velocità di taglio
		Giri/min nell'area del cambio: regolare i giri/min
		Passare ad un inserto più positivo (al limite in HSS)
	Ridurre la profondità di taglio	
Bava eccessiva nel foro di uscita	Avanzamento eccessivo	Ridurre l'avanzamento
	Portainseriti di tipo CC a 90°	Utilizzare portainseriti quadrati a 80°
	Forze di taglio troppo elevate	Ridurre la profondità di taglio Ridurre il raggio dell'inserto

RB 610 Teste per barenatura di sgrossatura – Panoramica

Connessione Graflex®

Connessione GL

Connessione BA

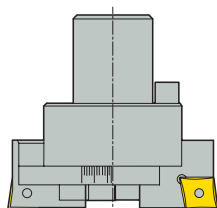

Ø 39–51 mm (Ø 1.535–2.008")

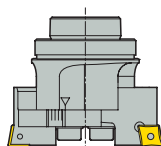

Ø 28–37 mm (Ø 1.102–1.457")

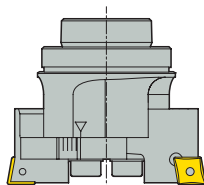

Ø 36–46 mm (Ø 1.417–1.811")

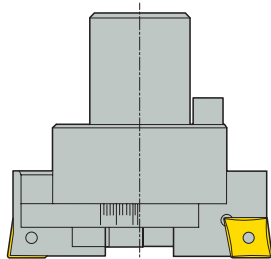

Ø 50–65 mm (Ø 1.969–2.559")

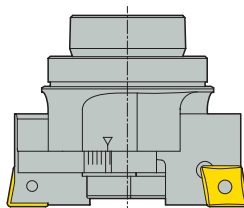

Ø 45–56 mm (Ø 1.772–2.205")

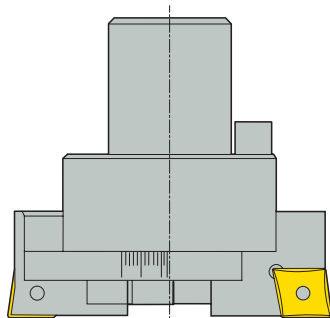

Ø 64–86 mm (Ø 2.520–3.386")

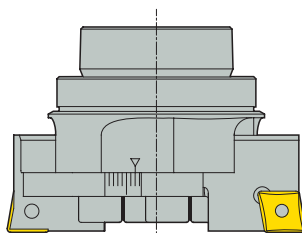

Ø 55–69 mm (Ø 2.165–2.717")

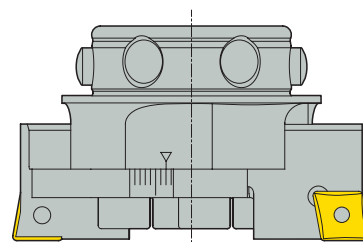

Ø 66–88 mm (Ø 2.598–3.465")

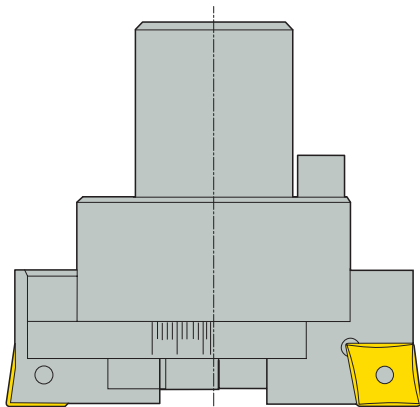

Ø 85–115 mm (Ø 3.346–4.528")

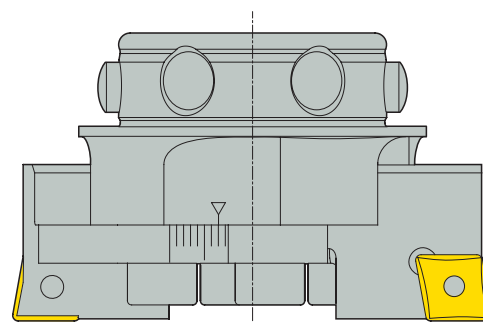

Ø 86–116 mm (Ø 3.386–4.567")

Introduzione

Foratura

Alesatura

Barenatura

Allegato

Testine RB 610 per barenatura di sgrossatura – Guida

Caratteristiche

- Un assemblato testina per barenatura di sgrossatura è costituito da 1 corpo (testina) e 2 portainseri
- Precisione del foro geometrico ottenuta a partire da fusione, taglio a fiamma o foratura
- Squilibrio minimo grazie a un design simmetrico

Compattezza

- Disegno compatto per massimizzare la rigidità dell'assemblato di barenatura e per consentire il miglior smorzamento delle vibrazioni quando usate su barre Steadyline® di tornitura e barenatura
- Peso ridotto per un più rapido cambio utensile e per una maggiore accelerazione del mandrino

Sistema di regolazione intuitivo e rapido

- Ciascun portainsero è caratterizzato da un meccanismo di regolazione "push and pull" che permette una regolazione del diametro facile e veloce, utilizzando un presetting
- L'indicatore del diametro visualizza la posizione del portainsero

Portainseri

- I portainseri A610...CC... per inserti romboidali hanno un angolo di attacco di 90°, angolo di taglio di 0° ed angolo di inclinazione di 0°
- I portainseri sono adatti sia alle testine per barenatura RB 610 Graflex® che alle unità di taglio di barenatura RB 610 GL

Produttività

- Alta rigidità grazie al contatto perfetto tra portainsero e corpo dell'unità di taglio di barenatura, reso possibile dalla pressione uniforme applicata dalla grande superficie di contatto delle viti
- Possibilità di ottenere una profondità di passata ap fino a metà dello spessore dell'inserto, massimizzando l'asportazione di truciolo e permettendo un utilizzo completo degli inserti
- Barenatura a gradino utilizzando uno spessore (fornito con la testina) su di un portainsero in modo da aumentare o suddividere l'impegno radiale
- Adduzione refrigerante interna diretta al tagliente

Gamma prodotti

- Le testine per barenatura di sgrossatura RB 610 sono disponibili con connessione Graflex® lato macchina, per operazioni di barenatura convenzionali fino a sporgenze 6xD,
- le testine per barenatura di sgrossatura RB 610 con connessioni lato macchina GL e BA sono progettate per sporgenze più lunghe con assemblati per smorzamento delle vibrazioni Steadyline®.

RB 610 Graflex®



- Graflex®: 4 testine compatte per barenatura di sgrossatura per Ø da 39 a 115 mm (Ø da 1,535 a 4,528")
- Il flessibile sistema modulare Graflex® consente di costruire assemblati di barenatura ottimali a partire da adattatori, moduli intermedi e testine per barenatura Graflex®

RB 610 GL e BA, per barre Steadyline® con smorzamento delle vibrazioni



GL



BA

- GL: 4 testine corte e compatte per barenatura di sgrossatura per Ø da 28 a 69 mm (Ø 1,102-2,717")
- BA: 2 testine corte e compatte per barenatura di sgrossatura per Ø da 66 a 116 mm (Ø da 2,598 a 4,567")
- Particolarmente adatte per barre di tornitura e barenatura Steadyline®. Le prestazioni in barenatura, quando usate su barre lunghe Steadyline®, sono simili a quelle degli assemblati più corti non antivibranti (<6xD).

Testine RB 610 per barenatura di sgrossatura – Guida

Regolazione della barenatura simmetrica:

La barenatura simmetrica si ottiene quando entrambi i taglienti sono regolati sullo stesso diametro e sulla stessa altezza.

Impostazione barenatura sfalsata (a gradino):

La barenatura a gradino si ottiene quando un tagliente sfalsato opera come tagliente di imbocco (entra nel foro per primo) su un diametro minore rispetto ad un secondo tagliente regolato sul diametro da ottenere: Richiede uno spessore (fornito con la testina per barenatura) da utilizzare tra il corpo della testina per barenatura ed un portainsero, per ottenere la sfalsatura assiale richiesta (+); vedere la tabella qui sotto.

Codice di ordinazione supporto	Spessore (mm)	Spessore (pollici)
AU6101003	0,2	0.008
AU6103003	0,4	0.016
AU6104003	0,5	0.020
AU6105003	0,6	0.024
AU6106003	0,6	0.024

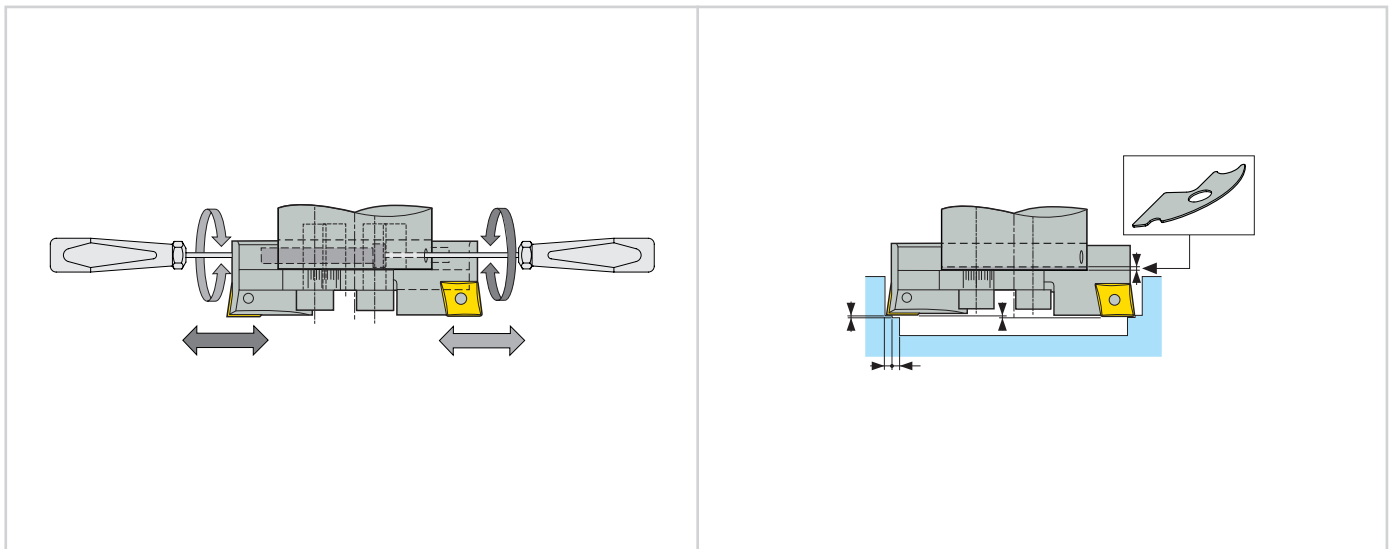

RB610

Graflex®

Introduzione

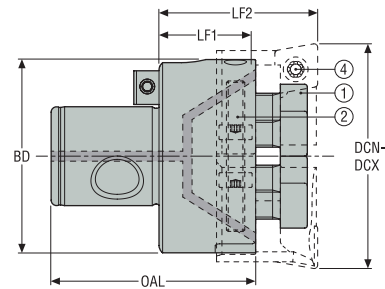

- Sono possibili la barenatura simmetrica e quella a gradino
- Meccanismo per la regolazione di ogni singolo portainseriti
- Adduzione interna di refrigerante verso il tagliente

1. Vite di assemblaggio e chiave di bloccaggio
- 2 & 4. Chiave per inserto da usare per la regolazione del diametro e per il serraggio della vite

Foratura

Codice di ordinazione	Codice prodotto	Lato macchina Dimensione Graflex	Lato utensile Capacità DCN-DCX Ø		OAL	LF1	LF2	BD	Peso	Max. num. di giri*
			mm <i>Inch</i>	mm <i>Inch</i>						
A61030	02904453	G3	39,0 <i>1.535</i>	51,0 <i>2.008</i>	43,5 <i>1.713</i>	23,5 <i>0.925</i>	36,4 <i>1.433</i>	34,0 <i>1.339</i>	0,18 <i>0.400</i>	7500
A61040	02904454	G4	50,0 <i>1.969</i>	65,0 <i>2.559</i>	45,5 <i>1.791</i>	21,5 <i>0.846</i>	35,3 <i>1.390</i>	43,0 <i>1.693</i>	0,4 <i>0.880</i>	5700
A61050	02904455	G5	64,0 <i>2.520</i>	86,0 <i>3.386</i>	55,0 <i>2.165</i>	25,0 <i>0.984</i>	42,3 <i>1.665</i>	54,0 <i>2.126</i>	0,7 <i>1.540</i>	4500
A61060	02904457	G6	85,0 <i>3.346</i>	115,0 <i>4.528</i>	69,0 <i>2.717</i>	29,0 <i>1.142</i>	47,8 <i>1.882</i>	63,0 <i>2.480</i>	1,0 <i>2.200</i>	3500

I portainseriti devono essere ordinati a parte, vedere le pagine 605

* Per ulteriori informazioni sul numero massimo di giri al minuto, vedere le pagine di istruzioni. Nota: Il peso è senza portainserito

Alesatura

Parti di ricambio, comprese nella fornitura

Per testa	Vite di assemblaggio	Spessore per barenatura a gradino	Tenone
A61030	950DC0616	AU6103003	90M31
A61040	950D0616	AU6104003	90M41
A61050	950D0820	AU6105003	90M51
A61060	950D0822	AU6106003	90M61

Barenatura

Accessori

Per testa	Chiave per vite staffa	Chiave (impugnatura a T)
A61030	03HL05	DOUBLE-T
A61040	03HL05	DOUBLE-T
A61050	03HL06	DOUBLE-T
A61060	03HL06	DOUBLE-T

Allegato

RB610 – Tipo compatto

GL

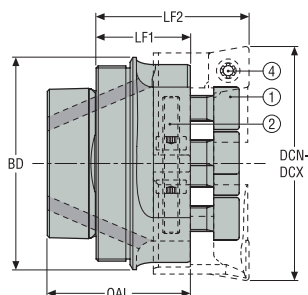

1. Vite di assemblaggio e chiave di bloccaggio
- 2 & 4. Chiave per inserto da usare per la regolazione del diametro e per il serraggio della vite

- Per barre di tornitura e barenatura Steadyline® GL25, GL32, GL40 e GL50
- Sono possibili la barenatura simmetrica e quella a gradino
- Meccanismo per la regolazione di ogni singolo portainseriti
- Adduzione interna di refrigerante verso il tagliente

Codice di ordinazione	Codice prodotto	Lato macchina Dimensione GL	Lato utensile Capacità DCN-DCX Ø		OAL	LF1	LF2	BD	Peso	Max. num. di giri*
			mm Inch	mm Inch						
GL25-RB610-10	03307854	GL25	28,0 1.102	37,0 1.457	21,7 0.854	16,2 0.638	25,0 0.984	25,0 0.984	0,1 0.220	9500
GL32-0610-20	02904458	GL32	36,0 1.417	46,0 1.811	27,6 1.087	21,1 0.831	32,0 1.260	32,0 1.260	0,2 0.440	7500
GL40-0610-30	02904459	GL40	45,0 1.772	56,0 2.205	31,6 1.244	22,1 0.870	35,0 1.378	40,0 1.575	0,3 0.660	5700
GL50-0610-40	02904460	GL50	55,0 2.165	69,0 2.717	33,7 1.327	22,2 0.874	36,0 1.417	50,0 1.969	0,3 0.660	4500

I portainseriti devono essere ordinati a parte, vedere le pagine 605

* Per ulteriori informazioni sul numero massimo di giri al minuto, vedere le pagine di istruzioni. Nota: Il peso è senza portainserito

Parti di ricambio, comprese nella fornitura

Per testa	Vite di assemblaggio	Spessore per barenatura a gradino
GL25-0610-10	950D0410	AU6101003
GL32-0610-20	950DC0412	AU6102003
GL40-0610-30	950DC0616	AU6103003
GL50-0610-40	950D0616	AU6104003

Accessori

Per testa	Chiave per vite staffa	Chiave per vite inserto	Chiave (impugnatura a T)
GL25-0610-10	03HL03	T07P-3	-
GL32-0610-20	03HL03	H4B-T07P	DOUBLE-T
GL40-0610-30	03HL05	-	DOUBLE-T
GL50-0610-40	03HL05	-	DOUBLE-T

Introduzione

Foratura

Alesatura

Barenatura

Allegato

RB610

BA

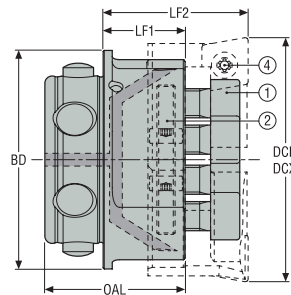

- Progettate per barre Steadyline® BA60 e BA80 per tornitura e barenatura
- Sono possibili la barenatura simmetrica e quella a gradino
- Meccanismo per la regolazione di ogni singolo portainseriti
- Adduzione interna di refrigerante verso il tagliente

1. Vite di assemblaggio e chiave di bloccaggio
- 2 & 4. Chiave per inserto da usare per la regolazione del diametro e per il serraggio della vite

Codice di ordinazione	Codice prodotto	Lato macchina Dimensione BA	Lato utensile Capacità DCN-DCX Ø		OAL	LF1	LF2	BD	Peso	Max. num. di giri*
			mm <i>Inch</i>	mm <i>Inch</i>						
BA060-RB610-50	03204092	BA060	66,0 <i>2.598</i>	88,0 <i>3.465</i>	38,5 <i>1.516</i>	22,5 <i>0.886</i>	39,8 <i>1.567</i>	60,0 <i>2.362</i>	0,7 <i>1.540</i>	4000
BA080-RB610-60	03204093	BA080	86,0 <i>3.386</i>	116,0 <i>4.567</i>	44,5 <i>1.752</i>	22,5 <i>0.886</i>	41,3 <i>1.626</i>	80,0 <i>3.150</i>	1,2 <i>2.650</i>	3000

I portainseriti devono essere ordinati a parte, vedere le pagine 605

* Per ulteriori informazioni sul numero massimo di giri al minuto, vedere le pagine di istruzioni. Nota: Il peso è senza portainserito

Parti di ricambio, comprese nella fornitura

Per testa	Chiave per vite staffa	Vite staffa	Chiave (impugnatura a T)	Spessore per barenatura a gradino
BA060-RB610-50	03HL06	950D0820	DOUBLE-T	AU6105003
BA080-RB610-60	03HL06	950D0822	DOUBLE-T	AU6106003

Introduzione

Foratura

Alesatura

Barenatura

Allegato

Portainseriti

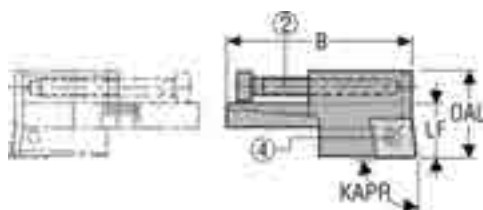

2. Vite di regolazione
4. Vite di bloccaggio inserto

• Per teste di barenatura RB 610 con connessione Graflex®, GL o BA

Codice di ordinazione	Codice prodotto	Per testa	Lato utensile		OAL	LF	B	Peso
			Capacità DCN-DCX	Ø				
			mm	mm	mm	mm	mm	kg
			Inch	Inch	Inch	Inch	Inch	lb
A61010CC0690	03307856	RB 61010	28,0 1.102	37,0 1.457	15,1 0.594	8,8 0.346	21,75 0.856	0,1 0.220
A61020CC0690	02971268	RB 61020	36,0 1.417	46,0 1.811	17,6 0.693	10,9 0.429	26,0 1.024	0,1 0.220
A61030CC0990	02904461	RB 61030	39,0 1.535	56,0 2.205	21,6 0.850	12,9 0.508	33,0 1.299	0,1 0.220
A61040CC0990	02904462	RB 61040	50,0 1.969	69,0 2.717	22,5 0.886	13,8 0.543	43,8 1.724	0,1 0.220
A61050CC1290	02904463	RB 61050	64,0 2.520	86,0 3.386	27,5 1.083	17,3 0.681	57,4 2.260	0,2 0.440
A61060CC1290	02904464	RB 61060	85,0 3.346	115,0 4.528	30,5 1.201	18,8 0.740	75,0 2.953	0,2 0.440

Parti di ricambio, comprese nella fornitura

Per portainserito	Vite di bloccaggio inserto	Vite di regolazione
		
A61010CC0690	C02504-T07P	-
A61020CC0690	C02504-T07P	19A61020
A61030CC0990	C04008-T15P	19A61030
A61040CC0990	C04008-T15P	19A61040
A61050CC1290	C05012-T15P	19A61050
A61060CC1290	C05012-T15P	19A61060

Per gli inserti consigliati per la barenatura di sgrossatura, vedere le pagine 682
Nota: Una chiave per il serraggio della vite inserto è fornita con le unità RB 610.

Testine RB 610 per barenatura di sgrossatura – Istruzioni

Coppie di serraggio raccomandate. Massimo avanzamento al giro nella barenatura a gradino.

Testine RB 610 per barenatura, dimensione	30	40	50	60
Coppia di serraggio della vite per il bloccaggio dei portainseriti (Nm)	2 x 25	4 x 25	4 x 40	4 x 40
Avanzamento f massimo in barenatura a gradino (mm/giro) (<i>pollici/giro</i>)	0,4 (0,016")	0,5 (0,020")	0,6 (0,024")	0,6 (0,024")

Condizioni di lavorazione consigliate potenza del mandrino:

Poiché la barenatura di sgrossatura richiede l'impiego di macchine ad alta potenza, raccomandiamo di verificare che la macchina sia idonea. La barenatura a gradino è una soluzione per ridurre le esigenze di potenza, poiché l'avanzamento è dimezzato a parità di profondità totale di taglio, rispetto all'impostazione simmetrica. Le migliori prestazioni si ottengono utilizzando lubrorefrigerante (parametri di lavorazione più elevati, migliore finitura superficiale, migliore evacuazione dei trucioli, maggiore durata dell'inserito).

Per istruzioni dettagliate, fare riferimento alle istruzioni operative fornite con le testine per barenatura e con le barre Steadyline®. Le istruzioni operative possono anche essere scaricate da www.secotools.com.

Velocità massime per testine RB 610 per barenatura di sgrossatura

NOTA! Le velocità massime mostrate sulle pagine prodotto dipendono dalla struttura meccanica delle testine per barenatura e dalla qualità di equilibratura.

Le velocità all'interno di questi limiti devono essere scelte in funzione delle altre condizioni di lavorazione, ad esempio materiale da lavorare, geometria del tagliente, lunghezza utensile, mandrino macchina.

Nelle applicazioni di barenatura con barre Steadyline®, non superare mai le massime velocità di rotazione delle barre stesse: Vedere le istruzioni operative fornite con le barre Steadyline® di tornitura e barenatura.



Barenatura di finitura

Le gamme (entro la tolleranza IT5) di prodotti per barenatura di finitura Seco, consentono di eseguire regolazioni di precisione nell'ordine dei micron e ottenere finiture superficiali di $Ra < 1$ (RMS 44 micropollici / senza). Con una costante attenzione a resistenza e rigidità, questi prodotti consentono di rispettare con facilità anche le specifiche più rigorose. Le soluzioni di smorzamento delle vibrazioni Steadyline™ completano la gamma per offrire livelli ancora più elevati di stabilità per la lavorazione di cavità profonde, dove sono necessarie lunghe sporgenze dell'utensile.

- Le testine per barenatura di finitura FB 760 Axiabore sono progettate per la finitura di fori di piccolo diametro.
- Ora la nostra serie di teste Axiabore™ per barenatura di finitura include anche la versione digitale, che facilita la vita dell'operatore e riduce la frequenza degli errori umani. La versione digitale facilita e velocizza le operazioni di setup in maniera affidabile ed efficiente su lavorazioni di alta precisione.
- Le testine per barenatura di finitura radiale FB 620/780/790 sono progettate per offrire le migliori geometrie del foro su diametri maggiori (fino a 205 mm).

Panoramica

Introduzione

Foratura

Alesatura

Barenatura

Allegato



Tornitura esterna



Scanalatura



Barenatura per taglio interrotto



Barenatura

Panoramica

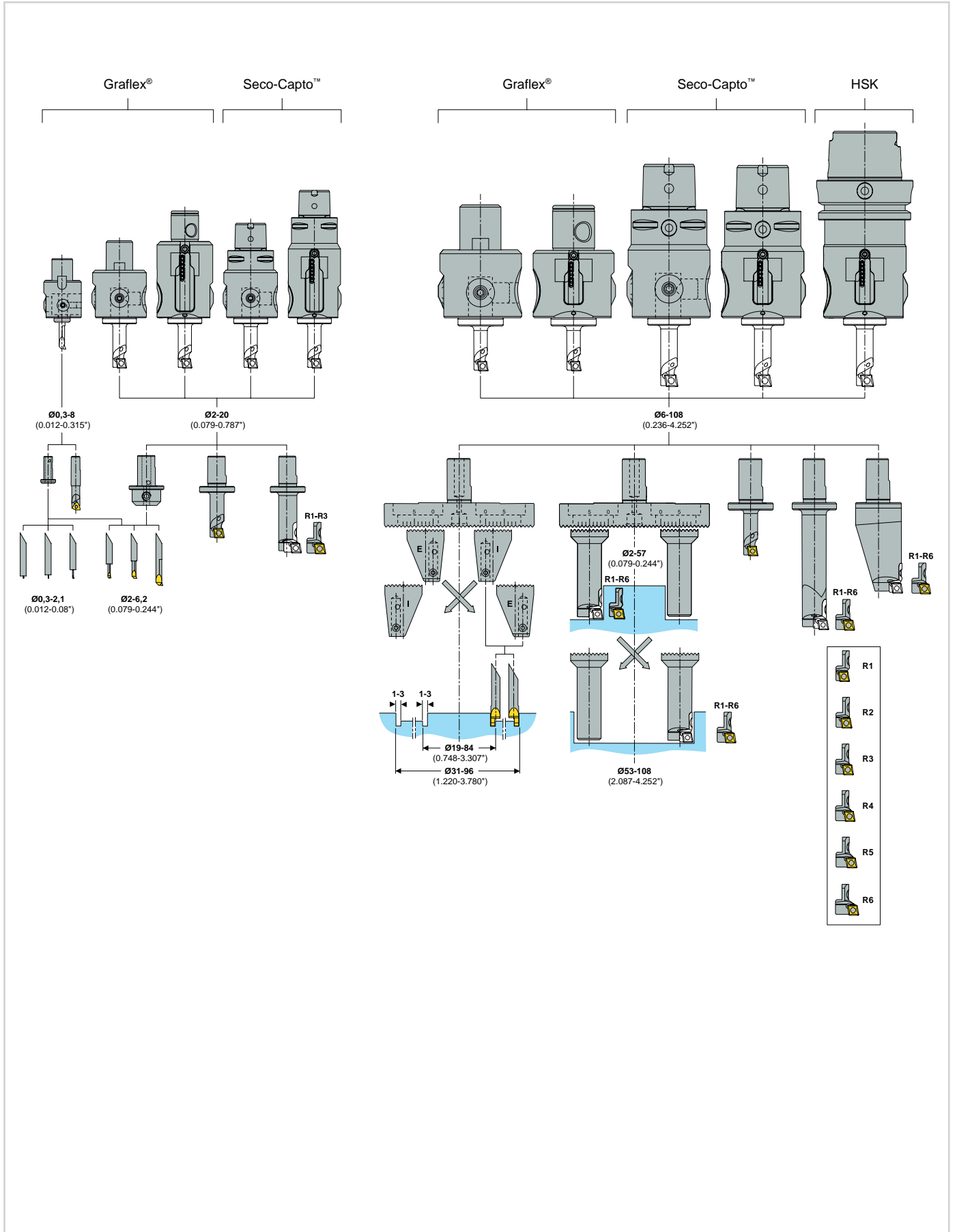

Teste di barenatura di finitura digitali di tipo assiale

Le teste di finitura assiali digitali offrono risultati eccellenti per le operazioni di barenatura (IT5 raggiungibile). L'utilizzo del nonio analogico è sostituito da un display digitale universale rimovibile: utilizzando il nonio di una testa analogica convenzionale può risultare difficile regolare il diametro in macchina. Con l'ampio display della serie FB 760 D è possibile effettuare questa operazione in maniera comoda e affidabile.

La serie FB 760 D rivoluziona il mondo della barenatura, in quanto elimina la necessità di una regolazione al presetting: tutte le operazioni di regolazione vengono effettuate direttamente sulla macchina, utilizzando il controller digitale.

Utensili per barenatura, stelo in metallo duro integrale Ø 4 mm (Ø 0,1574") per i diametri più piccoli Ø 2–108 mm (Ø 0,079–4,252"), angolo di attacco 98°. Gli utensili hanno all'estremità (lato macchina) un piano inclinato per l'orientamento del tagliente conforme agli standard ISO.

Custodia

Il display digitale viene fornito in una scatola esclusiva e sostenibile utile per riporre o caricare il controller.



Caratteristiche

Display digitale universale, per teste di barenatura di finitura FB 760 D.

Il controller digitale può essere utilizzato per tutta la gamma delle teste di barenatura digitali.

Dotato di un ampio display, permette di leggere facilmente il diametro in mm o in pollici.

Il display digitale è stato progettato per semplificarvi la vita:

- Display luminoso per facilitare la lettura - risoluzione di 1 µm
- Un sistema intuitivo e semplice da usare, con cui è facile passare dalla modalità assoluta a quella relativa (misura in mm e pollici),
- Controller autobloccante: Una volta collegato alla testa di barenatura, il controller rimane in posizione e consente all'operatore di utilizzare entrambe le mani per eseguire l'impostazione del diametro.
- Il controller digitale può essere utilizzato per tutta la gamma delle teste di barenatura digitali. Fornito con un cavo USB, il controller digitale può essere alimentato dalla porta USB della macchina o del computer.



Testine Axiabore™ per barenatura di finitura per fori di Ø da 0,3 a 108 mm (0,012-4,252")

Sceita testa di tipo Axiabore™	Capacità Ø mm	Capacità Ø pollici	HSM / Velocità massime	Digitale	Equilibrabili	Geometria del foro	Produttivo ed economico
Nanobore™ (dimensione 1)	0,3-8	0.012-0.315"	30000 Giri al minuto			■ ■	■ ■
Axiabore™ (dimensione 2)	2-20	0.079-0.787"	12000 Giri al minuto			■	■ ■
Teste digitali Axiabore™ (dimensione 2)	2-20	0.079-0.787"	12000 Giri al minuto	✓		■	■ ■
Axiabore™ Plus (dimensione 3)	6-108	0.236-4.252"	8000* Giri al minuto oppure 1000 m/min			■	■ ■ ■
Teste digitali Axiabore™ Plus (dimensione 3)	6-108	0.236-4.252"	8000* Giri al minuto oppure 1000 m/min	✓		■	■ ■ ■
Axialibrabore™ Plus (dimensione 3)	6-108	0.236-4.252"	20000* Giri al minuto oppure 1500 m/min		✓	■ ■	■

* Massimo 5000 giri al minuto quando si utilizza MPA.

5 le testine Axiabore™ sono disponibili con connessione Graflex®, Seco-Capto™ o HSK-A

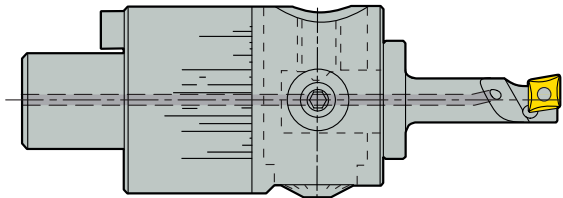

Nanobore™ (dimensione 1)
Axiabore™ (dimensione 2)
Teste digitali Axiabore™ (dimensione 2)
Axiabore™ Plus (dimensione 3)
Teste digitali Axiabore™ Plus (dimensione 3)
Axialibrabore™ Plus (dimensione 3)

2 testine Axiabore™ per barenatura di finitura FB 760 con connessione Seco-Capto™ per fori: Ø 2-108 mm (0,079-4,252")

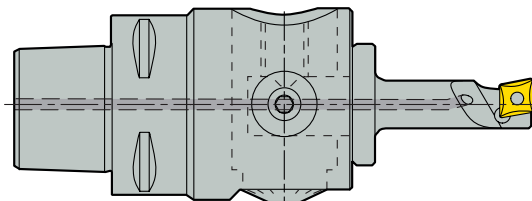

Axiabore™ – C3-391.0760-02
Axiabore™ Plus – C5-391.0760-03
Teste digitali Axiabore™ – C3-391.FB760-02-D
Teste digitali Axiabore™ Plus – C5-391.FB760-03-D

NOTA! Le testine per barenatura di finitura Seco-Capto™ possono barenare fori di Ø minimo 2 mm (0,079"), con la più piccola dimensione Seco-Capto™ C3. Per Ø da 0,3 a 8 mm (0,012-0,315") usare una testina per barenatura Nanobore™ con dimensione di connessione G2, insieme all'appropriato adattatore Seco-Capto™/Graflex®.

Adattatore Seco-Capto™ e testina Graflex®: Ø 0,3-8 mm (0,012-0,315")

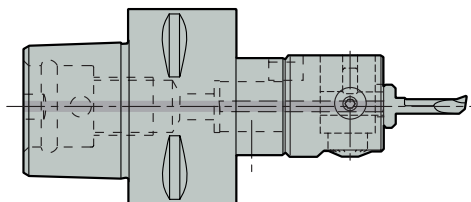

Adattatori ed estensioni modulari Graflex® e Seco-Capto™: consultare il catalogo Tooling Systems (Sistemi di Utensili).

NOTA! Caratteristiche, istruzioni (procedura di montaggio dell'utensile, impostazione del diametro, procedura di assemblaggio MPA (adattatore multi-uso), velocità massime, velocità di taglio consigliate, risoluzione dei problemi), portainseri ed inserti sono simili per entrambe le tipologie di testine per barenatura di finitura FB 760, a parità di capacità di barenatura, indipendentemente dal tipo di connessione.

Display digitale per teste di barenatura di finitura digitali



Utensili di barenatura

Nota! Sulle pagine prodotto è indicato chiaramente quali utensili sono idonei a quale testina.

Utensili per barenatura, stelo in carburo integrale Ø 4 mm ($\varnothing 0,1574^{\circ}$) per i diametri più piccoli Ø 0,3–6,2 mm ($\varnothing 0,012-0,244^{\circ}$), angolo di incidenza 98°. Richiedere bussolle di riduzione da inserire nelle testine Nanobore™ e Axia(libra) bore™. Gli utensili hanno all'estremità (lato macchina) un piano inclinato per l'orientamento del tagliente conforme agli standard ISO.

Barre di barenatura, ad inserto Ø 6, 12 o 16 mm ($\varnothing 0,236, 0,472, 0,630^{\circ}$) per Ø 6–13 mm ($\varnothing 0,236-0,512^{\circ}$), in "acciaio" per utensili corti, in "metallo duro" per utensili lunghi. Per inserti WB..0301.. o CC..0602.. e angolo di attacco di 90°. Montaggio diretto sulle testine. Il piano di bloccaggio consente l'orientamento del tagliente conformemente agli standard ISO.

Barre di barenatura, modulari composte da uno "stelo" e da un "portainserito" per Ø 13–63 mm ($\varnothing 0,512-2,480^{\circ}$). Steli Ø 12 o 16 mm ($\varnothing 0,472, 0,630^{\circ}$) in "acciaio" per utensili corti, "metallo duro" per utensili lunghi e "leggeri/in alluminio" per i diametri più grandi. Montaggio diretto sulle testine.

Sei portainseriti per inserti CC..0602.. e angolo di attacco di 90°, compatibili con tutti gli steli per ottenere un'ampia capacità di barenatura con lo stesso stelo.



Adattatore multi-uso (MPA)

MPA per la barenatura e la tornitura esterna, nonché scanalatura frontale sulla testina Axiabore™ Plus. L'MPA e gli utensili sono dotati di un'interfaccia dentellata, per un orientamento preciso e incrementi di posizionamento di 2,5 mm sul diametro (0,098"). Ugello refrigerante incluso.

Selezionare i componenti per costruire un utensile di tipo adattatore multi-uso nella specifica tabella di selezione MPA. Vedere dettagli assemblato nel capitolo dedicato alle istruzioni.

Comporre un assemblato di barenatura o di tornitura esterna.

Sia gli assemblati di barenatura sia quelli per la tornitura esterna utilizzano lo stesso stelo dotato di un portainserito e di un contrappeso. Assemblati di barenatura: selezionare il portainserito appropriato da assemblare sullo stelo del gruppo di barenatura/tornitura esterna, utilizzando la tabella di selezione del portautensile "Barenatura con MPA" (parte delle pagine prodotto seguenti).

Assemblato tornitura esterna: selezionare il portainserito appropriato da assemblare sullo stelo del gruppo di barenatura/tornitura esterna, utilizzando la tabella di selezione del portautensile "Tornitura esterna con MPA" (parte delle pagine prodotto seguenti). Vedere dettagli assemblato nel capitolo dedicato alle istruzioni.

Costruzione di un assemblato per scanalatura

Un gruppo scanalato richiede:

- Un paio di portautensili di scanalatura (uno E="Esterno" e uno I="Interno")
- Un utensile di scanalatura "contro il centraggio" o "contro il foro". Quando la scanalatura non è contro la parete di un centraggio né contro la parete di un foro, sono adatti entrambi i tipi di utensili. Vedere la tabella di selezione "Utensili di scanalatura per scanalatura con MPA".



Caratteristiche

Testina Nanobore™, codice di ordinazione A76001



Testina ultrapiùcola per barenatura di finitura \varnothing 0,3–8 mm (\varnothing 0,012–0,315"):
Diametro esterno 25 mm (0,984"), lunghezza 25 mm (0,984"), con connettore Graflex® misura G2, attacco utensile \varnothing 6 mm (0,236").
Velocità di funzionamento fino a 30.000 giri/min per lavorazioni ad alte prestazioni di diametri molto piccoli.

La bussola di riduzione 6–4 mm (0,236–0,157") con il piano e la spina di orientamento per l'utensile integrale è inclusa nella fornitura.

Risoluzione dell'impostazione del diametro: 2,5 μ m (0,0001")

Testina Axiabore™, codice di ordinazione A76002



Testine piccole per barenatura di finitura \varnothing 2–20 mm (\varnothing 0,079–0,787"):
Diametro esterno 36,5 mm (1,401"), lunghezza 32 mm (1,260"), con collegamento Graflex® di dimensioni G3 e Seco-Capto™ di misura C3, attacco utensile \varnothing 12 mm (0,472"). Queste dimensioni della testina sono ottimizzate per fori di difficile accesso.

La bussola di riduzione 12-4 mm (0,472-0,157") con il piano e la spina di orientamento per l'utensile integrale è inclusa nella fornitura.

NOTA! Possono anche essere montati utensili più piccoli da Nanobore™ 0,3–2,1 mm (0,012–0,083"), ma la velocità di lavorazione sarà limitata a 12.000 giri/min: è preferibile usare la testina Nanobore®.

Risoluzione dell'impostazione del diametro: 2,5 μ m (0,0001") sul diametro per teste analogiche, 1 μ m (0,00004") sul diametro per teste digitali

Testina Axiabore™ Plus, codici di ordinazione A76003 e C5-391.0760-03



Testine multi-uso per barenatura di finitura \varnothing 6–108 mm (\varnothing 0,236–4,252"), tornitura esterna \varnothing 2–57 mm (\varnothing 0,079–2,244") e scanalatura \varnothing 19–96 mm (\varnothing 0,748–3,780").

Diametro esterno 54 mm (0,2126"), lunghezza 45 mm (0,1772"), con connessione Graflex® di misura 5 e Seco-Capto™ di misura 5, raccordo utensile \varnothing 16 mm (0,630").

Utensili idonei: tutti gli utensili con stelo \varnothing 16 mm (0,630"), per montaggio diretto sulle testine.

Questa testina può montare anche l'adattatore multi-uso (MPA) per la barenatura di diametri grandi, per tornitura esterna e per scanalatura assiale.

Risoluzione dell'impostazione del diametro: 2,5 μ m (0,0001") sul diametro per teste analogiche, 1 μ m (0,00004") sul diametro per teste digitali

Testina Axialibrabore™ Plus - Codice di ordinazione A76013



Testina equilibrabile per barenatura di finitura \varnothing 6–33 mm (\varnothing 0,236–1,299"):

Stesse caratteristiche della testina Axiabore™ Plus, ma con equilibratura di precisione, lunghezza del corpo 65 mm (2,559").
Con connessione Graflex® dimensione G5.

Le testine con equilibratura di finitura permettono di raggiungere velocità più elevate, fino a 20.000 giri/min o 1.500 m/min (a seconda di quale di questi valori viene raggiunto per primo senza essere superato), migliorano la geometria del foro e riducono le sollecitazioni sul mandrino della macchina.

L'equilibratura "LibraOne" è effettuata impostando l'anello di equilibratura graduato in linea con il segno riportato sulla testina per barenatura (codice di equilibratura dell'utensile usato e diametro da barenare). Non è necessaria alcuna tabella.

L'equilibratura di precisione è possibile solo per gli utensili di barenatura più piccoli con \varnothing da 6 a 33 mm (\varnothing 0,236–1,299").

NOTA! Se si utilizza un utensile più grande "Alu" o "MPA" dalla testina Axiabore™ Plus su quella Axialibrabore™ Plus, l'equilibratura di precisione non è possibile e l'anello di equilibratura deve essere impostato sulla posizione di pre-equilibratura della testina (a seconda dell'operazione da eseguire, vedere il capitolo Istruzioni).

La velocità massima diventa la stessa della testina Axiabore™ Plus.

Risoluzione dell'impostazione del diametro: 2,5 μ m (0,0001")

FB 760 – Teste di tipo Axiabore™, non equilibrabili

Graflex®

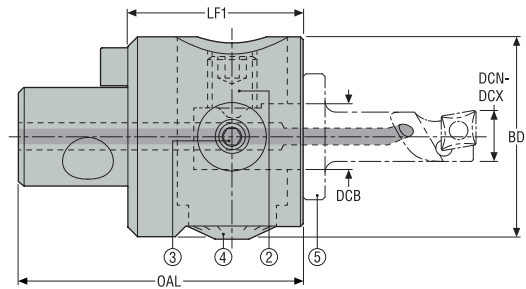

- Con regolazione micrometrica (incremento 0,01 mm e nonio 2,5 µm, sul diametro)
- Axiabore™ Plus – Consente la barenatura, la tornitura esterna e la scanalatura frontale

3. Vite di bloccaggio
4. Vite di regolazione micrometrica
2. Vite di assemblaggio
5. Utensile

Codice di ordinazione	Codice prodotto	Lato macchina Dimensione Graflex	Lato utensile Capacità DCN-DCX Ø		OAL	LF1	BD	DCB	Peso *	Max velocità operativa**	
			mm Inch	mm Inch						Max. num. di giri**	Max. m/min**
A76001	02462575	G2	0,3 0.012	8,0 0.315	41,0 1.614	25,0 0.984	25,0 0.984	6,0 0.236	0,2 0.440	-	30000 1500
A76002	02594930	G3	2,0 0.079	20,0 0.787	52,0 2.047	32,0 1.260	36,5 1.437	12,0 0.472	0,4 0.880	-	12000 1500
A76003	02594935	G5	6,0 0.236	108,0 4.252	75,0 2.953	45,0 1.772	54,0 2.126	16,0 0.630	0,9 1.980	*	8000 1000

Nota: Il peso è senza portainserto

Per gli utensili, vedere le pagine 621-623

Capacità - Axiabore™ Plus - testa di barenatura 6-108 mm (0,236-4,252), tornitura esterna 2-57 mm (0,079-2,244*), scanalatura frontale 19-96 mm (0,748-3,780*).
 **Massimo 5000 giri al minuto quando si utilizza MPA.

**La velocità massima, a seconda di quale viene raggiunta per prima, senza superarla.

Parti di ricambio, comprese nella fornitura

Per testa	Vite di assemblaggio	Chiave (impugnatura a T)	Chiave	Vite di bloccaggio	Bussola di riduzione	Sealing Screws	Tenone
A76001	-	DOUBLE-T	H4B-H2.0	19M4001A	05A7600604	950A0406	90M21
A76002	AU7601212	-	03M03C	19A71030	05A7601204	-	90M3A
A76003	AU7601312	DOUBLE-T	H6B-H4.0L	19A71008125	-	-	90M5A

Accessori

Per testa	Chiave dinamometrica per viti di bloccaggio dell'anello di equilibratura	Chiave dinamometrica per viti di bloccaggio e di assemblaggio
A76001	-	H00-2009
A76002	-	H00-3030
A76003	H00T-4060	-

Introduzione

Foratura

Alesatura

Barenatura

Allegato

FB 760 – Teste di tipo Axiabore™, equilibrabili

Graflex®

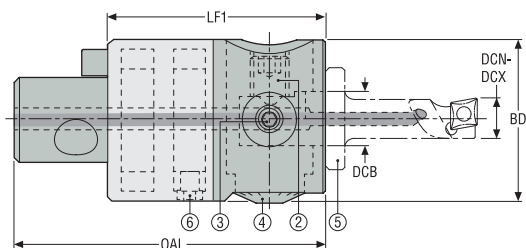

6. Vite di bloccaggio 2
3. Vite di bloccaggio 1
4. Vite di regolazione micrometrica
2. Vite di assemblaggio
5. Utensile



- Sistema di equilibratura integrato LibraOne basato su un unico anello di regolazione dell'equilibratura
- Con regolazione micrometrica (incremento 0,01 mm e nonio 2,5 µm, sul diametro)

Codice di ordinazione	Codice prodotto	Lato macchina Dimensione Graflex	Lato utensile Capacità DCN-DCX Ø		OAL	LF1	BD	DCB	Peso *	Max velocità operativa**	
			mm Inch	mm Inch						Max. num. di giri**	Max. m/min**
A76013	02594943	G5	6,0 0.236	33,0 1.299	95,0 3.740	65,0 2.559	54,0 2.126	16,0 0.630	1,2 2.650	*	20000 1500

Nota: Il peso è senza portainserito

Per gli utensili, vedere le pagine 621-623

*Capacità - Axiabore™ Plus - testa equilibrabile.

**La velocità massima, a seconda di quale viene raggiunta per prima, senza superarla.

Parti di ricambio, comprese nella fornitura

Per testa	Vite di assemblaggio	Chiave (impugnatura a T)	Chiave	Vite di bloccaggio 1	Vite di bloccaggio 2	Tenone
A76013	AU7601312	DOUBLE-T	H6B-H4.0L	19A71008125	AU7601318	90M5A1

Accessori

Per testa	Chiave dinamometrica per viti di bloccaggio dell'anello di equilibratura	Chiave dinamometrica per viti di bloccaggio e di assemblaggio
A76013	H00-4020-60	H00T-4060

Introduzione

Foratura

Alesatura

Barenatura

Allegato

Teste digitali Axiabore FB 760 D, non equilibrabili

Graflex®

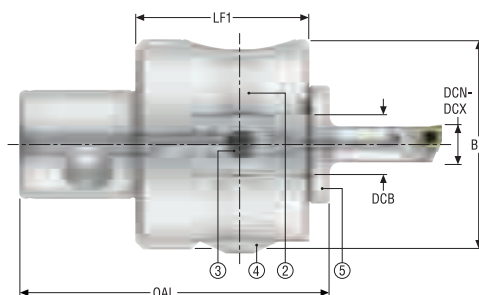

- Compatibile con il display digitale per visualizzare l'incremento della misura sull'ampio display (il display digitale deve essere ordinato separatamente)
- Axiabore™ Plus – Consente la barenatura, la tornitura esterna e la scanalatura frontale

3. Staffa
4. Vite di regolazione micrometrica
2. Vite di assemblaggio
5. Utensile

Codice di ordinazione	Codice prodotto	Lato macchina Dimensione Graflex	Lato utensile Capacità DCN-DCX Ø		OAL	LF1	BD	DCB	Peso	Max velocità operativa**	
			mm Inch	mm Inch						Max. num. di giri**	Max. m/min**
G3-FB760-02-D	10215570	G3	2,0 0.079	20,0 0.787	70,0 2.756	50,0 1.969	36,5 1.437	12,0 0.472	0,5 1.100	12000	1500
G5-FB760-03-D	10215571	G5	6,0 0.236	108,0 4.252	75,0 2.953	45,0 1.772	54,0 2.126	16,0 0.630	0,9 1.980	8000	1000

Nota: Il peso è senza portainserto

**La velocità massima, a seconda di quale viene raggiunta per prima, senza superarla.

I portainserti e il controller digitale universale devono essere ordinati a parte (vedere le pagine successive).

Parti di ricambio, comprese nella fornitura

Per	Vite di assemblaggio	Chiave (impugnatura a T)	Chiave	Vite di bloccaggio
G3	AU7601212	-	03M03C	19A71030
G5	AU7601312	DOUBLE-T	H6B-H4.0L	19A71008125

Accessori

Per	Bussola di riduzione	Chiave dinamometrica
G3	05A7601204	H00-3030
G5	-	H00-3030

Introduzione

Foratura

Alesatura

Barenatura

Allegato

Teste digitali Axiabore FB 760 D

Seco-Capto™

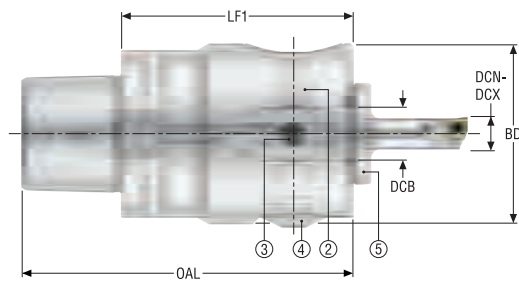

3. Staffa
4. Vite di regolazione micrometrica
2. Vite di assemblaggio
5. Utensile



- Compatibile con il display digitale per visualizzare l'incremento della misura sull'ampio display (il display digitale deve essere ordinato separatamente)
- Axiabore™ Plus – Consente la barenatura, la tornitura esterna e la scanalatura frontale

Codice di ordinazione	Codice prodotto	Lato macchina Dimensione Capto	Lato utensile Capacità DCN-DCX Ø		OAL	LF1	BD	DCB	Peso	Max velocità operativa**	
			mm <i>Inch</i>	mm <i>Inch</i>						Max. num. di giri**	Max. m/min**
C3-391.FB760-02-D	10215575	C3	2,0 <i>0.079</i>	20,0 <i>0.787</i>	89,0 <i>3.504</i>	70,0 <i>2.756</i>	36,5 <i>1.437</i>	12,0 <i>0.472</i>	0,5 <i>1.100</i>	12000	1500
C5-391.FB760-03-D	10215576	C5	6,0 <i>0.236</i>	108,0 <i>4.252</i>	100,0 <i>3.937</i>	70,0 <i>2.756</i>	54,0 <i>2.126</i>	16,0 <i>0.630</i>	1,3 <i>2.870</i>	8000	1000

Nota: Il peso è senza portainserito

**La velocità massima, a seconda di quale viene raggiunta per prima, senza superarla.

I portainseriti e il controller digitale universale devono essere ordinati a parte (vedere le pagine successive).

Parti di ricambio, comprese nella fornitura

Per	Vite di assemblaggio	Chiave (impugnatura a T)	Chiave	Vite di bloccaggio
C3	AU7601212	-	03M03C	19A71030
C5	AU7601312	DOUBLE-T	H6B-H4.0L	19A71008125

Accessori

Per	Bussola di riduzione	Chiave dinamometrica
C3	05A7601204	H00-3030
C5	-	H00-3030

Introduzione

Foratura

Alesatura

Barenatura

Allegato

FB 760 – Teste di tipo Axiabore™

HSK-A

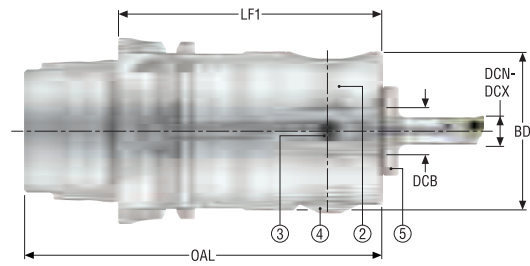

- Compatibile con il display digitale per visualizzare l'incremento della misura sull'ampio display (il display digitale deve essere ordinato separatamente)
- Axiabore™ Plus – Consente la barenatura, la tornitura esterna e la scanalatura frontale

3. Staffa
4. Vite di regolazione micrometrica
2. Vite di assemblaggio
5. Utensile





Codice di ordinazione	Codice prodotto	Lato macchina Dimensione Graflex	Lato utensile Capacità DCN-DCX Ø		OAL	LF1	BD	DCB	Peso	Max velocità operativa**	
			mm Inch	mm Inch						Max. num. di giri**	Max. m/min**
HSKA63-FB760-03-D	10215578	HSK-A63	6,0 0.236	108,0 4.252	122,0 4.803	90,0 3.543	54,0 2.126	16,0 0.630	1,8 3.970	8000	1000

Nota: Il peso è senza portainserito

**La velocità massima, a seconda di quale viene raggiunta per prima, senza superarla.

I portainseriti e il controller digitale universale devono essere ordinati a parte (vedere le pagine successive).

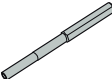
Parti di ricambio, comprese nella fornitura

Per	Vite di assemblaggio	Chiave (impugnatura a T)	Chiave	Vite di bloccaggio
HSKA	 AU7601312	 DOUBLE-T	 H6B-H4.0L	 19A71008125

Accessori

Per	Chiave dinamometrica
HSKA	 H00-3030

Display digitale per teste di barenatura digitali



- Display digitale per teste di barenatura di finitura digitali
- Un unico display digitale che può essere utilizzato con tutte le teste di barenatura
- È possibile impostare il diametro in mm o in pollici
- Display reversibile con magnete per una migliore presa quando montato sulla testa di barenatura durante il setup
- Batteria interna ricaricabile

Codice di ordinazione	Codice prodotto	L	H	Peso
		mm Inch	mm Inch	kg lb
990FBDD01	10215579	74,25 2.92	36 1.42	0,2 0.008

FB 760 – Teste di tipo Axiabore™

Seco-Capto™

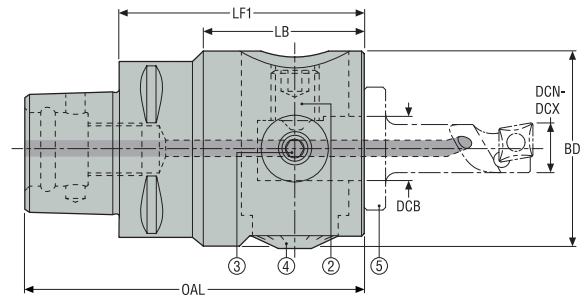

- 3. Staffa
- 4. Vite di regolazione micrometrica
- 2. Vite di assemblaggio
- 5. Utensile

- Con regolazione micrometrica (incremento 0,01 mm e nonio 2,5 µm, sul diametro)
- Axiabore™ Plus – Consente la barenatura, la tornitura esterna e la scanalatura frontale

Codice di ordinazione	Codice prodotto	Lato macchina	Lato utensile		OAL	LF1	LB	BD	DCB	Peso	*	Max velocità operativa**	
			Capacità DCN-DCX Ø									Max. num. di giri**	Max. m/min**
			mm	mm	mm	mm	mm	mm	mm	kg			
			Inch	Inch	Inch	Inch	Inch	Inch	Inch	lb			
C5-391.0760-03	02822777	C5	6,0	108,0	95,0	65,0	44,0	54,0	16,0	1,2	*	8000	1500
			0.236	4.252	3.740	2.559	1.732	2.126	0.630	2.650			

Nota: Il peso è senza portainserito

Per gli utensili, vedere le pagine 621-623

*Massimo 5000 giri al minuto quando si utilizza MPA.

**Capacità - Axiabore™ Plus - testa di barenatura 6-108 mm (0,236-4,252"), tornitura esterna 2-57 mm (0,079-2,244"), scanalatura frontale 19-96 mm (0,748-3,780").

Parti di ricambio, comprese nella fornitura

Per testa	Vite di assemblaggio	Chiave (impugnatura a T)	Chiave	Vite di bloccaggio
C5-...-03	AU7601312	DOUBLE-T	H6B-H4.0L	19A71008125

Accessori

Chiave dinamometrica per viti di bloccaggio e di assemblaggio



H00-3030

Utensili per barenatura, metallo duro integrale

per teste FB 760

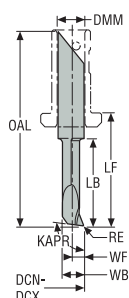

- Ideali per teste di barenatura digitali e analogiche
- KAPR 98°
- Orientamento del tagliente ISO
- Refrigerante lungo l'utensile
- Materiale dell'utensile: Metallo duro*

Codice di ordinazione	Codice prodotto	Per testa	Capacità DCN-DCX		OAL	LB	LF	DMM	WB	WF	RE	Parametri di taglio consigliati** a _p	Parametri di taglio consigliati** f	Peso	Codice equilibratura
			mm	mm											
A761402	02462579	FB 76001	0,3	0,6	30,7	1,2	15,5	4,0	0,25	0,1	0,0	0,02	0,01	0,01	-
			0.012	0.024	1.209	0.047	0.610	0.157	0.010	0.004	-	0.001	0	0.020	
A761412	02462581	FB 76001	0,5	1,1	30,7	2,0	15,5	4,0	0,45	0,2	0,0	0,02	0,01	0,1	-
			0.020	0.043	1.209	0.079	0.610	0.157	0.018	0.008	-	0.001	0	0.220	
A761422	02462583	FB 76001	1,0	2,1	30,7	5,0	15,5	4,0	0,95	0,45	0,1	0,03	0,02	0,1	-
			0.039	0.083	1.209	0.197	0.610	0.157	0.037	0.018	0.004	0.001	0.001	0.220	
A761432	02462584	FB 76001/02/12	2,0	3,2	30,7	8,0	15,5	4,0	1,8	0,88	0,1	0,05	0,02	0,1	E13
			0.079	0.126	1.209	0.315	0.610	0.157	0.071	0.035	0.004	0.002	0.001	0.220	
A761442	02462586	FB 76001/02/12	3,0	4,7	30,7	10,0	15,5	4,0	2,75	1,35	0,15	0,06	0,03	0,1	E14
			0.118	0.185	1.209	0.394	0.610	0.157	0.108	0.053	0.006	0.002	0.001	0.220	
A761452	02462587	FB 76001/02/12	4,5	6,2	35,7	15,0	20,5	4,0	3,95	1,95	0,15	0,08	0,03	0,1	E15
			0.177	0.244	1.406	0.591	0.807	0.157	0.156	0.077	0.006	0.003	0.001	0.220	

*Questi utensili con codolo di diam. 4 mm richiedono l'uso di una bussola di riduzione, fornita con le teste e i kit adatti.

** Per le velocità di taglio consigliate, vedere le pagine 686-689

*** Capacità complementare raggiungibile di +0,1 mm.

Teste di barenatura, tipo di inserto

per teste FB 760

Introduzione

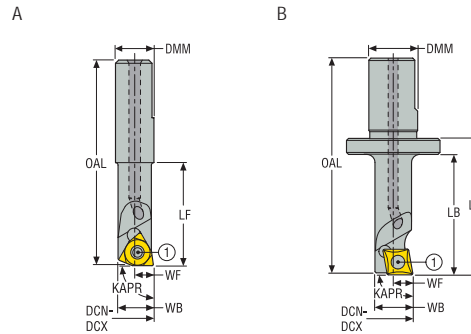

1 = Vite di bloccaggio inserto

Foratura

- Ideali per teste di barenatura digitali e analogiche
- Orientamento del tagliente ISO
- Adduzione refrigerante interna
- Solo due misure di inserti per tutti gli utensili
- Materiale dell'utensile * = Acciaio, tipo di Inserto sostituibile
- Materiale dell'utensile ** = Metallo duro, tipo di Inserto
- KAPR 90°

Alesatura

Codice di ordinazione	Codice prodotto	Materiale utensile	Per testa	** Capacità DCN-DCX Ø		OAL	LB	LF	DMM	WB	WF	Peso	Disegno	Dimensione inserto	Codice equilibratura
				mm Inch	mm Inch										
A762001	02462590	*	FB 76001	6,0 0.236	8,0 0.315	31,7 1.248	0,0 -	16,0 0.630	6,0 0.236	5,5 0.217	2,9 0.114	0,1 0.220	A	WB...0301..	-
A762002	02594947	*	FB 76002/12	6,0 0.236	8,0 0.315	39,7 1.563	16,0 0.630	20,0 0.787	12,0 0.472	5,5 0.217	2,9 0.114	0,1 0.220	B	WB...0301..	S21
A762003	02594967	*	FB 76003/13	6,0 0.236	8,0 0.315	50,2 1.976	16,0 0.630	21,0 0.827	16,0 0.630	5,5 0.217	2,9 0.114	0,1 0.220	B	WB...0301..	S31
A763002	02594948	*	FB 76002/12	8,0 0.315	10,0 0.394	45,7 1.799	22,0 0.866	26,0 1.024	12,0 0.472	7,4 0.291	3,9 0.154	0,1 0.220	B	WB...0301..	S22
A763003	02594968	*	FB 76003/13	8,0 0.315	10,0 0.394	56,2 2.213	22,0 0.866	27,0 1.063	16,0 0.630	7,4 0.291	3,9 0.154	0,1 0.220	B	WB...0301..	S32
A765002	02594957	*	FB 76002/12	10,0 0.394	13,0 0.512	53,5 2.106	30,0 1.181	34,0 1.339	12,0 0.472	9,35 0.368	4,8 0.189	0,1 0.220	B	CC...0602..	S23
A765003	02594969	*	FB 76003/13	10,0 0.394	13,0 0.512	64,0 2.520	30,0 1.181	35,0 1.378	16,0 0.630	9,35 0.368	4,8 0.189	0,1 0.220	B	CC...0602..	S33
A762201	02462591	**	FB 76001	6,0 0.236	8,0 0.315	41,7 1.642	0,0 -	26,0 1.024	6,0 0.236	5,5 0.217	2,9 0.114	0,1 0.220	A	WB...0301..	-
A762202	02594958	**	FB 76002/12	6,0 0.236	8,0 0.315	50,7 1.996	27,0 1.063	31,0 1.220	12,0 0.472	5,5 0.217	2,9 0.114	0,1 0.220	B	WB...0301..	E21
A762203	02594970	**	FB 76003/13	6,0 0.236	8,0 0.315	61,2 2.409	27,0 1.063	32,0 1.260	16,0 0.630	5,5 0.217	2,9 0.114	0,2 0.440	B	WB...0301..	E31
A763202	02594961	**	FB 76002/12	8,0 0.315	10,0 0.394	60,7 2.390	37,0 1.457	41,0 1.614	12,0 0.472	7,4 0.291	3,9 0.154	0,1 0.220	B	WB...0301..	E22
A763203	02594971	**	FB 76003/13	8,0 0.315	10,0 0.394	71,2 2.803	37,0 1.457	42,0 1.654	16,0 0.630	7,4 0.291	3,9 0.154	0,2 0.440	B	WB...0301..	E32
A765202	02594962	**	FB 76002/12	10,0 0.394	13,0 0.512	78,5 3.091	55,0 2.165	59,0 2.323	12,0 0.472	9,35 0.368	4,8 0.189	0,1 0.220	B	CC...0602..	E23
A765203	02594972	**	FB 76003/13	10,0 0.394	13,0 0.512	89,0 3.504	55,0 2.165	60,0 2.362	16,0 0.630	9,35 0.368	4,8 0.189	0,2 0.440	B	CC...0602..	E33

**Capacità complementare raggiungibile di +0,2 mm.

Allegato

Parti di ricambio, comprese nella fornitura

Per dimensione inserto	Vite di bloccaggio inserto
WB...0301..	C02035-T06P
CC...0602..	C02504-T07P

Accessori

Chiave per vite inserto	Chiave (impugnatura a T)
H4B-T06P	DOUBLE-T
H4B-T07P	DOUBLE-T

Codoli per barenatura, per teste di barenatura di finitura modulari

per teste FB 760

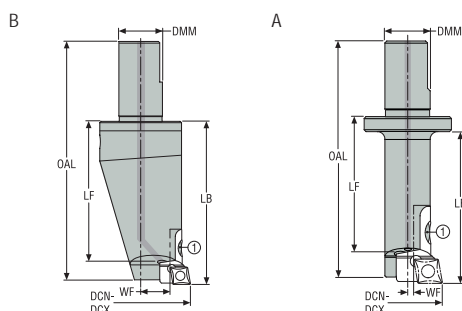

1 = Vite di bloccaggio



- Diverse capacità ottenibili con portainseri intercambiabili
- Tipi di codolo "acciaio" per barre corte, "metallo duro" per barre lunghe, "alluminio" per barre grandi
- Adduzione refrigerante interna

Codice di ordinazione	Codice prodotto	Attacco per barenatura di tipo modulare	Per testa	** Capacità DCN-DCX Ø		***	OAL	LB	LF	DMM	WF	Peso	Disegno
				mm	mm								
A760S20	02594963	Acciaio	FB 76002/12	13,0 0.512	20,0 0.787		62,5 2.461	40,0 1.575	34,0 1.339	12,0 0.472	1,4 0.055	0,1 0.220	A
A760S30	02594973	Acciaio	FB 76003/13	13,0 0.512	18,0 0.709		73,0 2.874	40,0 1.575	35,0 1.378	16,0 0.630	1,4 0.055	0,1 0.220	A
A760S31	02594974	Acciaio	FB 76003/13	18,0 0.709	33,0 1.299		83,0 3.268	50,0 1.969	45,0 1.772	16,0 0.630	3,9 0.154	0,1 0.220	A
A760E20	02594964	Metallo duro	FB 76002/12	13,0 0.512	20,0 0.787		82,5 3.248	60,0 2.362	54,0 2.126	12,0 0.472	1,4 0.055	0,2 0.440	A
A760E30	02594965	Metallo duro	FB 76003/13	13,0 0.512	18,0 0.709		103,0 4.055	70,0 2.756	65,0 2.559	16,0 0.630	1,4 0.055	0,2 0.440	A
A760E31	02594966	Metallo duro	FB 76003/13	18,0 0.709	33,0 1.299		113,0 4.449	80,0 3.150	75,0 2.953	16,0 0.630	3,9 0.154	0,3 0.660	A
A760A32	02594977	Alluminio	FB 76003/13	33,0 1.299	48,0 1.890	***	88,0 3.465	60,0 2.362	50,0 1.969	16,0 0.630	11,5 0.453	0,2 0.440	B
A760A33	02594978	Alluminio	FB 76003/13	48,0 1.890	63,0 2.480	***	108,0 4.252	80,0 3.150	70,0 2.756	16,0 0.630	19,0 0.748	0,4 0.880	B

Nota: Il peso è senza portainsero.

**Capacità complementare raggiungibile di +0,2 mm.

*** Se utilizzato su A760 13, non è possibile l'equilibratura fine. Selezionare le combinazioni di codolo e portainseri desiderate utilizzando la tabella di selezione alle pagine 625.

Parti di ricambio, comprese nella fornitura

Per testa	Vite di bloccaggio
A76002/12	C04008-T15P
A76003/13	C04008-T15P
A76003	C04008-T15P



Accessori

Chiave (impugnatura a T)
DOUBLE-T
DOUBLE-T
DOUBLE-T



Portainseri, per teste di barenatura di finitura modulari

per teste FB 760

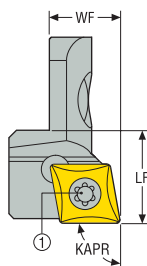

1 = Vite di bloccaggio inserto

- Singola misura di montaggio adatta per tutti i codoli di barenatura (e tornitura esterna)
- Una misura di inserti per tutti i portainseri

Codice di ordinazione	Codice prodotto	LF	WF*	Peso	Dimensione inserto	KRINS°
		mm Inch	mm Inch	kg lb		
A765R1	02594979	10,0 0.394	4,95 0.195	0,1 0.220	CC..0602..	90
A765R2	02594983	10,0 0.394	6,2 0.244	0,1 0.220	CC..0602..	90
A765R3	02594984	10,0 0.394	7,45 0.293	0,1 0.220	CC..0602..	90
A765R4	02594987	10,0 0.394	8,7 0.343	0,1 0.220	CC..0602..	90
A765R5	02594989	10,0 0.394	9,97 0.393	0,1 0.220	CC..0602..	90
A765R6	02594990	10,0 0.394	11,2 0.441	0,1 0.220	CC..0602..	90

*WF se utilizzato con inserto di tipo CC..060204.

Selezionare le combinazioni di codolo e portainseri desiderate utilizzando la tabella di selezione alle pagine 625.

Parti di ricambio, comprese nella fornitura

Per dimensione inserto	Vite di bloccaggio inserto
CC..0602...	C02504-T07P



Accessori

Chiave per vite inserto	Chiave (impugnatura a T)
H4B-T07P	DOUBLE-T



Introduzione

Foratura

Alesatura

Barenatura

Allegato

Tabella di selezione:
Utensili per barenatura e portainseriti adatti per teste FB 760

Per testa	Capacità di barenatura DCN-DCX		Lunghezza di barenatura LB		Codice di ordinazione		DMM		Dimensione inserto	Tipo utensile	
	Ø mm	inch	mm	inch	Utensile per barenatura	Portainserito	mm	inch			
A760 01	0,3-0,6	0.012-0.024	1,2	0.047	A761402	-	4	0.157	-	Metallo duro	
	0,5-1,1	0.020-0.043	2	0.078	A761412	-	4	0.157	-	Metallo duro	
	1-2,1	0.039-0.083	-	-	A761422	-	4	0.157	-	Metallo duro	
	2-3,2	0.079-0.126	8	0.315	A761432	-	4	0.157	-	Metallo duro	
	3-4,7	0.118-0.185	10	0.394	A761442	-	4	0.157	-	Metallo duro	
	4,5-6,2	0.177-0.244	15	0.591	A761452	-	4	0.157	-	Metallo duro	
	6-8	0.236-0.315	16	0.630	A762001	-	6	0.236	WB..0301..	Acciaio, tipo di inserti	
	6-8	0.236-0.315	26	1.024	A762201	-	6	0.236	WB..0301..	Metallo duro, tipo di inserti	
A760 02/ A760 12	2-3,2	0.079-0.126	8	0.315	A761432	-	4	0.157	-	Metallo duro	
	3-4,7	0.118-0.185	10	0.394	A761442	-	4	0.157	-	Metallo duro	
	4,5-6,2	0.177-0.244	15	0.591	A761452	-	4	0.157	-	Metallo duro	
	6-8	0.236-0.315	16	0.630	A762002	-	12	0.472	WB..0301..	Acciaio, tipo di inserti	
	6-8	0.236-0.315	27	1.063	A762202	-	12	0.472	WB..0301..	Metallo duro, tipo di inserti	
	8-10	0.315-0.394	22	0.866	A763002	-	12	0.472	WB..0301..	Acciaio, tipo di inserti	
	8-10	0.315-0.394	37	1.457	A763202	-	12	0.472	WB..0301..	Metallo duro, tipo di inserti	
	10-13	0.394-0.512	30	1.181	A765002	-	12	0.472	CC..0602..	Acciaio, tipo di inserti	
	10-13	0.394-0.512	55	2.165	A765202	-	12	0.472	CC..0602..	Metallo duro, tipo di inserti	
	13-15,5	0.512-0.610	40	1.575	A760S20	A765R1	12	0.472	CC..0602..	Codolo in acciaio con portainserito	
	13-15,5	0.512-0.610	60	2.362	A760E20	A765R1	12	0.472	CC..0602..	Codolo in metallo duro con portainseriti	
	15,5-18	0.610-0.709	40	1.575	A760S20	A765R2	12	0.472	CC..0602..	Codolo in acciaio con portainserito	
	15,5-18	0.610-0.709	60	2.362	A760E20	A765R2	12	0.472	CC..0602..	Codolo in metallo duro con portainseriti	
	18-20	0.709-0.787	40	1.575	A760S20	A765R3	12	0.472	CC..0602..	Codolo in acciaio con portainserito	
	18-20	0.709-0.787	60	2.362	A760E20	A765R3	12	0.472	CC..0602..	Codolo in metallo duro con portainseriti	
	A760 03/ A760 13	6-8	0.236-0.315	16	0.630	A762003	-	16	0.630	WB..0301..	Acciaio, tipo di inserti
		6-8	0.236-0.315	32	1.260	A762203	-	16	0.630	WB..0301..	Metallo duro, tipo di inserti
		8-10	0.315-0.394	22	0.866	A763003	-	16	0.630	WB..0301..	Acciaio, tipo di inserti
8-10		0.315-0.394	37	1.457	A763203	-	16	0.630	WB..0301..	Metallo duro, tipo di inserti	
10-13		0.394-0.512	30	1.181	A765003	-	16	0.630	CC..0602..	Acciaio, tipo di inserti	
10-13		0.394-0.512	55	2.165	A765203	-	16	0.630	CC..0602..	Metallo duro, tipo di inserti	
13-15,5		0.512-0.610	40	1.575	A760S30	A765R1	16	0.630	CC..0602..	Codolo in acciaio con portainserito	
13-15,5		0.512-0.610	70	2.756	A760E30	A765R1	16	0.630	CC..0602..	Codolo in metallo duro con portainseriti	
15,5-18		0.610-0.709	40	1.575	A760S30	A765R2	16	0.630	CC..0602..	Codolo in acciaio con portainserito	
15,5-18		0.610-0.709	70	2.756	A760E30	A765R2	16	0.630	CC..0602..	Codolo in metallo duro con portainseriti	
18-20,5		0.709-0.807	50	1.969	A760S31	A765R1	16	0.630	CC..0602..	Codolo in acciaio con portainserito	
18-20,5		0.709-0.807	80	3.150	A760E31	A765R1	16	0.630	CC..0602..	Codolo in metallo duro con portainseriti	
20,5-23		0.807-0.906	50	1.969	A760S31	A765R2	16	0.630	CC..0602..	Codolo in acciaio con portainserito	
20,5-23		0.807-0.906	80	3.150	A760E31	A765R2	16	0.630	CC..0602..	Codolo in metallo duro con portainseriti	
23-25,5		0.906-1.00	50	1.969	A760S31	A765R3	16	0.630	CC..0602..	Codolo in acciaio con portainserito	
23-25,5		0.906-1.00	80	3.150	A760E31	A765R3	16	0.630	CC..0602..	Codolo in metallo duro con portainseriti	
25,5-28		1.004-1.102	50	1.969	A760S31	A765R4	16	0.630	CC..0602..	Codolo in acciaio con portainserito	
25,5-28		1.004-1.102	80	3.150	A760E31	A765R4	16	0.630	CC..0602..	Codolo in metallo duro con portainseriti	
28-30,5		1.102-1.201	50	1.969	A760S31	A765R5	16	0.630	CC..0602..	Codolo in acciaio con portainserito	
28-30,5		1.102-1.201	80	3.150	A760E31	A765R5	16	0.630	CC..0602..	Codolo in metallo duro con portainseriti	
30,5-33		1.201-1.299	50	1.969	A760S31	A765R6	16	0.630	CC..0602..	Codolo in acciaio con portainserito	
30,5-33		1.201-1.299	80	3.150	A760E31	A765R6	16	0.630	CC..0602..	Codolo in metallo duro con portainseriti	
33-35,5*		1.299-1.398*	60	2.362	A760A32	A765R1	16	0.630	CC..0602..	Codolo in alluminio con portainserito	
35,5-38*		1.299-1.496*	60	2.362	A760A32	A765R2	16	0.630	CC..0602..	Codolo in alluminio con portainserito	
38-40,5*		1.496-1.594*	60	2.362	A760A32	A765R3	16	0.630	CC..0602..	Codolo in alluminio con portainserito	
40,5-43*		1.594-1.693*	60	2.362	A760A32	A765R4	16	0.630	CC..0602..	Codolo in alluminio con portainserito	
43-45,5*		1.693-1.791*	60	2.362	A760A32	A765R5	16	0.630	CC..0602..	Codolo in alluminio con portainserito	
45,5-48*		1.791-1.890*	60	2.362	A760A32	A765R6	16	0.630	CC..0602..	Codolo in alluminio con portainserito	
48-50,5*		1.890-1.988*	80	3.150	A760A33	A765R1	16	0.630	CC..0602..	Codolo in alluminio con portainserito	
50,5-53*		1.988-2.087*	80	3.150	A760A33	A765R2	16	0.630	CC..0602..	Codolo in alluminio con portainserito	
53-55,5*		2.087-2.185*	80	3.150	A760A33	A765R3	16	0.630	CC..0602..	Codolo in alluminio con portainserito	
55,5-58*		2.185-2.283*	80	3.150	A760A33	A765R4	16	0.630	CC..0602..	Codolo in alluminio con portainserito	
58-60,5*		2.283-2.382*	80	3.150	A760A33	A765R5	16	0.630	CC..0602..	Codolo in alluminio con portainserito	
60,5-63*		2.382-2.480*	80	3.150	A760A33	A765R6	16	0.630	CC..0602..	Codolo in alluminio con portainserito	

Per diametri maggiori, vedere la sezione MPA (Multi-purpose adapter, adattatore multiuso).

* Se utilizzato su A760 13, non è possibile l'equilibratura fine.

Adattatore multi-uso (MPA)

per teste FB 760

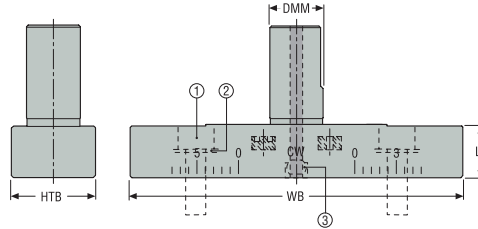

- Ideali per teste Axiabore™ Plus digitali e analogiche - Solo testa A760 03**
- Per montare un codolo e un contrappeso (per la barenatura o la tornitura esterna) o due portautensili per scanalatura (per la scanalatura frontale)
- Adduzione refrigerante interna con ugello regolabile (3)

1. Vite di assemblaggio
2. Rondella
3. Ugello regolabile

Introduzione

Foratura

		Capacità DCN-DCX Ø										
Codice di ordinazione	Codice prodotto	Per barenatura		Per tornitura diam. esterno		Per scanalatura		HTB	LF	DMM	WB	Peso
		mm <i>Inch</i>	mm <i>Inch</i>	mm <i>Inch</i>	mm <i>Inch</i>	mm <i>Inch</i>	mm <i>Inch</i>	mm <i>Inch</i>	mm <i>Inch</i>	mm <i>Inch</i>	mm <i>Inch</i>	kg <i>lb</i>
BDA16BS25100	02595014	53,0 2.087	108,0 4.252	2,0 0.079	57,0 2.244	31,0 1.220	96,0 3.780	25,0 0.984	16,0 0.630	16,0 0.630	100,0 3.937	0,3 0.660

Parti di ricambio, comprese nella fornitura

Per	Vite di assemblaggio	Rondella
BDA16BS25100	950D0618	940ZC06

*Se utilizzato su una testa - Axialibratore™ Plus - A760 13 non è possibile eseguire l'equilibratura di precisione, vedere le pagine 613
 Selezionare i componenti necessari per realizzare assiemi di barenatura, tornitura esterna o scanalatura, utilizzando le pagine seguenti 630-641

Accessori

Per testa	Chiave per vite staffa
BDA16BS25100	03HL05

Alesatura

Barenatura

Allegato

Codolo e contrappeso, per barenatura o tornitura esterna su un MPA

per teste FB 760

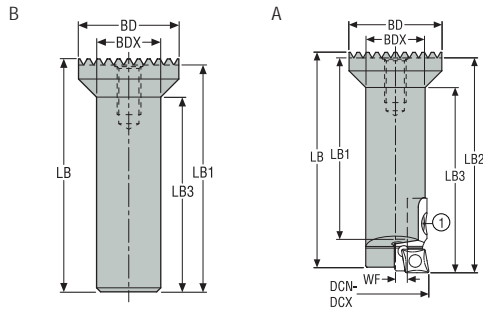

1. Vite di assemblaggio



- Per il montaggio su MPA
- Il codolo può essere utilizzato per la barenatura o per la tornitura esterna
- Utilizza gli stessi portainseriti dei codoli per barenatura modulare

Codice di ordinazione	Codice prodotto	Disegno	** Capacità DCN-DCX Ø											Disegno	
			Per barenatura				Per tornitura diam. esterno				WF	BDX	BD		Peso
			mm	mm	mm	mm	mm	mm	mm	mm					
BAS25MH1660	02595019	Attacco*	53,0	108,0	2,0	57,0	58,5	48,5	58,5	50,0	4,0	16,0	25,0	0,1	A
			2.087	4.252	0.079	2.244	2.303	1.909	2.303	1.969	0.157	0.630	0.984	0.220	
BAS25CW1660	02595016	Contrappeso	53,0	108,0	2,0	57,0	58,0	56,6	-	48,5	-	16,0	25,0	0,2	B
			2.087	4.252	0.079	2.244	2.283	2.228	-	1.909	-	0.630	0.984	0.440	

*I portainseriti devono essere ordinati a parte, vedere le pagine 624

**Le capacità di barenatura e di tornitura esterna sono correlate al portainserito selezionato e alla posizione di regolazione dei codoli utilizzando la "tabella di selezione dei portainseriti per barenatura o per tornitura esterna" alle pagine 630-641

Parti di ricambio, comprese nella fornitura

Per	Vite di assemblaggio
BAS25MH1660	C04008-T15P
BAS25CW1660	-

Accessori

Chiave (impugnatura a T)
DOUBLE-T
-

Portautensili per scanalatura, per scanalatura frontale su un MPA

per teste FB 760

Introduzione

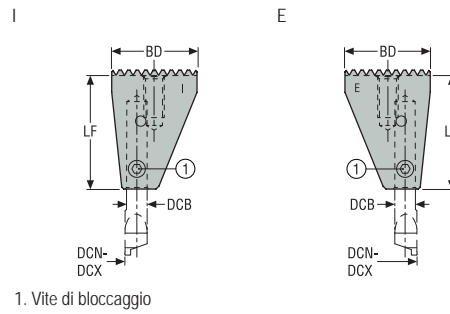

- Per il montaggio su MPA
- Un portautensili per scanalatura viene utilizzato con il relativo utensile o per fungere da contrappeso

Foratura

Codice di ordinazione	Codice prodotto	Disegno	* Capacità DCN-DCX Ø		DCB	LF	BD	Peso	Disegno
			mm	mm					
BAS25FGI35	02595021	Portautensile per scanalatura I (interna)*	19,0 0.748	76,0 2.992	6,0 0.236	35,0 1.378	25,0 0.984	0,1 0.220	I (Interna)
BAS25FGE35	02595020	Portautensile per scanalatura E (esterna)*	39,0 1.535	96,0 3.780	6,0 0.236	35,0 1.378	25,0 0.984	0,1 0.220	E (Esterna)

*Utensili per scanalatura da ordinare a parte, vedere le pagine 629

* La capacità nella scanalatura è correlata all'utensile per scanalatura selezionato, alla posizione di regolazione e all'orientamento del portautensili, utilizzando le "tabelle di selezione dell'utensile per scanalatura sul centraggio o sul foro", vedere le pagine 630-641

Alesatura

Parti di ricambio, comprese nella fornitura

Per	Vite di bloccaggio
BAS25FGI35	950L0607T15P
BAS25FGE35	950L0607T15P



Accessori

Chiave (impugnatura a T)
DOUBLE-T
DOUBLE-T



Barenatura

Allegato

Utensili per scanalatura

per teste FB 760

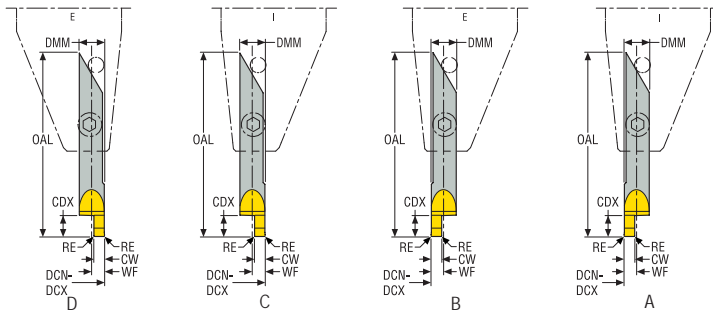

- Utilizzabile per portautensili per scanalatura "esterna" o "interna", a seconda della capacità

Codice di ordinazione	Codice prodotto	Disegno	* Capacità DCN-DCX Ø								OAL	CW	RE	DMM	WF	Prof. max. **	Peso	
			Disegno A		Disegno B		Disegno C		Disegno D									
			mm	mm	mm	mm	mm	mm	mm	mm								mm
			Inch	Inch	Inch	Inch	Inch	Inch	Inch	Inch	Inch	Inch	Inch	Inch	Inch	Inch	Inch	kg
AFG0629101582	02595028	Contro il centraggio	19,0 0.748	64,0 2.520	39,0 1.535	84,0 3.307	-	-	-	-	42,0 1.654	1,0 0.039	0,15 0.006	6,0 0.236	2,95 0.116	2,0 0.079	0,07 0.150	
AFG0629151582	02595029	Contro il centraggio	19,0 0.748	64,0 2.520	39,0 1.535	84,0 3.307	-	-	-	-	42,0 1.654	1,5 0.059	0,15 0.006	6,0 0.236	2,95 0.116	3,0 0.118	0,07 0.150	
AFG0629201582	02595031	Contro il centraggio	19,0 0.748	64,0 2.520	39,0 1.535	84,0 3.307	-	-	-	-	42,0 1.654	2,0 0.079	0,15 0.006	6,0 0.236	2,95 0.116	5,0 0.197	0,1 0.220	
AFG0629251582	02595032	Contro il centraggio	19,0 0.748	64,0 2.520	39,0 1.535	84,0 3.307	-	-	-	-	42,0 1.654	2,5 0.098	0,15 0.006	6,0 0.236	2,95 0.116	5,0 0.197	0,1 0.220	
AFG0629301582	02595033	Contro il centraggio	19,0 0.748	64,0 2.520	39,0 1.535	84,0 3.307	-	-	-	-	42,0 1.654	3,0 0.118	0,15 0.006	6,0 0.236	2,95 0.116	6,0 0.236	0,1 0.220	
AFG0629101581	02595022	Contro il foro	-	-	-	-	31,0 1.220	76,0 2.992	51,0 2.008	96,0 3.780	42,0 1.654	1,0 0.039	0,15 0.006	6,0 0.236	2,95 0.116	2,0 0.079	0,1 0.220	
AFG0629151581	02595023	Contro il foro	-	-	-	-	31,0 1.220	76,0 2.992	51,0 2.008	96,0 3.780	42,0 1.654	1,5 0.059	0,15 0.006	6,0 0.236	2,95 0.116	3,0 0.118	0,07 0.150	
AFG0629201581	02595024	Contro il foro	-	-	-	-	31,0 1.220	76,0 2.992	51,0 2.008	96,0 3.780	42,0 1.654	2,0 0.079	0,15 0.006	6,0 0.236	2,95 0.116	4,0 0.157	0,1 0.220	
AFG0629251581	02595026	Contro il foro	-	-	-	-	31,0 1.220	76,0 2.992	51,0 2.008	96,0 3.780	42,0 1.654	2,5 0.098	0,15 0.006	6,0 0.236	2,95 0.116	5,0 0.197	0,1 0.220	
AFG0629301581	02595027	Contro il foro	-	-	-	-	31,0 1.220	76,0 2.992	51,0 2.008	96,0 3.780	42,0 1.654	3,0 0.118	0,15 0.006	6,0 0.236	2,95 0.116	6,0 0.236	0,1 0.220	

* La capacità nella scanalatura è correlata all'utensile per scanalatura selezionato, alla posizione di regolazione e all'orientamento del portautensili, utilizzando le "tabelle di selezione dell'utensile per scanalatura sul centraggio o sul foro", vedere le pagine 630-641

** Profondità massima scanalatura CDX

Parti di ricambio, comprese nella fornitura

Utensile per scanalatura -verso centraggio-

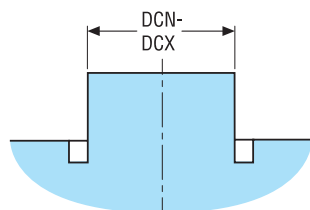

Utensile per scanalatura -verso foro-



Tabella di selezione:
 Utensili per barenatura e portainseriti adatti per teste FB 760, In mm

	Capacità DCN-DCX Ø mm*	Portainserito Descrizione	Posizione del codolo	Dimensioni in mm					Angolo di attacco KRINS°	Dimensione inserto
				BD	BD1	LF	LB	WB		
	53-55,5	A765 R1	0	16	25	58,5	50	17	90°	CC..0602..
	55,5-58	A765 R2	0	16	25	58,5	50	18,2	90°	CC..0602..
	58-60,5	A765 R1	1	16	25	58,5	50	17	90°	CC..0602..
		A765 R3	0	16	25	58,5	50	19,5	90°	CC..0602..
	60,5-63	A765 R2	1	16	25	58,5	50	18,2	90°	CC..0602..
		A765 R4	0	16	25	58,5	50	20,7	90°	CC..0602..
	63-65,5	A765 R1	2	16	25	58,5	50	17	90°	CC..0602..
		A765 R3	1	16	25	58,5	50	19,5	90°	CC..0602..
	65,5-68	A765 R5	0	16	25	58,5	50	22	90°	CC..0602..
		A765 R2	2	16	25	58,5	50	18,2	90°	CC..0602..
	68-70,5	A765 R4	1	16	25	58,5	50	20,7	90°	CC..0602..
		A765 R6	0	16	25	58,5	50	23,3	90°	CC..0602..
	70,5-73	A765 R1	3	16	25	58,5	50	17	90°	CC..0602..
		A765 R3	2	16	25	58,5	50	19,5	90°	CC..0602..
	73-75,5	A765 R5	1	16	25	58,5	50	22	90°	CC..0602..
		A765 R2	3	16	25	58,5	50	18,2	90°	CC..0602..
	75,5-78	A765 R4	2	16	25	58,5	50	20,7	90°	CC..0602..
		A765 R6	1	16	25	58,5	50	23,2	90°	CC..0602..
	78-80,5	A765 R1	4	16	25	58,5	50	17	90°	CC..0602..
		A765 R3	3	16	25	58,5	50	19,5	90°	CC..0602..
	80,5-83	A765 R5	2	16	25	58,5	50	22	90°	CC..0602..
		A765 R2	4	16	25	58,5	50	18,2	90°	CC..0602..
	83-85,5	A765 R4	3	16	25	58,5	50	20,7	90°	CC..0602..
		A765 R6	2	16	25	58,5	50	23,2	90°	CC..0602..
	85,5-88	A765 R1	5	16	25	58,5	50	17	90°	CC..0602..
		A765 R3	4	16	25	58,5	50	19,5	90°	CC..0602..
	88-90,5	A765 R5	3	16	25	58,5	50	22	90°	CC..0602..
		A765 R2	5	16	25	58,5	50	18,2	90°	CC..0602..
	90,5-93	A765 R4	4	16	25	58,5	50	20,7	90°	CC..0602..
		A765 R6	3	16	25	58,5	50	23,2	90°	CC..0602..
	93-95,5	A765 R1	6	16	25	58,5	50	17	90°	CC..0602..
		A765 R3	5	16	25	58,5	50	19,5	90°	CC..0602..
	95,5-98	A765 R5	4	16	25	58,5	50	22	90°	CC..0602..
		A765 R2	6	16	25	58,5	50	18,2	90°	CC..0602..
	98-100,5	A765 R4	5	16	25	58,5	50	20,7	90°	CC..0602..
		A765 R6	4	16	25	58,5	50	23,2	90°	CC..0602..
	100,5-103	A765 R1	7	16	25	58,5	50	17	90°	CC..0602..
		A765 R3	6	16	25	58,5	50	19,5	90°	CC..0602..
	103-105,5	A765 R5	5	16	25	58,5	50	22	90°	CC..0602..
		A765 R2	7	16	25	58,5	50	18,2	90°	CC..0602..
	105,5-108	A765 R4	6	16	25	58,5	50	20,7	90°	CC..0602..
		A765 R6	5	16	25	58,5	50	23,2	90°	CC..0602..

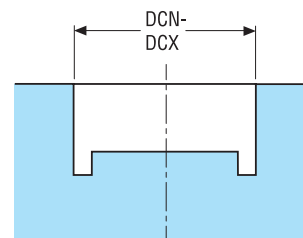
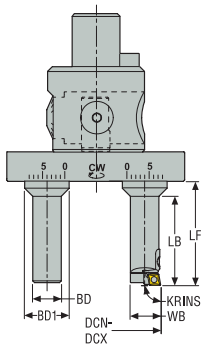

* + 0,2 mm (0.008") di capacità complementare raggiungibile.
 Per la descrizione dettagliata dei portainseriti, vedere pagina(e) 624

Introduzione

Foratura

Alesatura

Barenatura

Allegato

Tabella di selezione:
Utensili per barenatura e portainseriti adatti per teste FB 760, Pollici

	Capacità DCN-DCX Ø inch*	Portainserito Descrizione	Posizione del codolo	Dimensioni in pollici					Angolo di attacco KRINS°	Dimensione inserto
				BD	BD1	LF	LB	WB		
	2.087-2.185	A765 R1	0	0.630	0.984	2.303	1.969	0.669	90°	CC..0602..
	2.185-2.283	A765 R2	0	0.630	0.984	2.303	1.969	0.717	90°	CC..0602..
	2.283-2.382	A765 R1	1	0.630	0.984	2.303	1.969	0.669	90°	CC..0602..
		A765 R3	0	0.630	0.984	2.303	1.969	0.768	90°	CC..0602..
	2.382-2.480	A765 R2	1	0.630	0.984	2.303	1.969	0.717	90°	CC..0602..
		A765 R4	0	0.630	0.984	2.303	1.969	0.815	90°	CC..0602..
	2.480-2.579	A765 R1	2	0.630	0.984	2.303	1.969	0.669	90°	CC..0602..
		A765 R3	1	0.630	0.984	2.303	1.969	0.768	90°	CC..0602..
	2.579-2.677	A765 R5	0	0.630	0.984	2.303	1.969	0.866	90°	CC..0602..
		A765 R2	2	0.630	0.984	2.303	1.969	0.717	90°	CC..0602..
	2.677-2.776	A765 R4	1	0.630	0.984	2.303	1.969	0.815	90°	CC..0602..
		A765 R6	0	0.630	0.984	2.303	1.969	0.917	90°	CC..0602..
	2.776-2.874	A765 R1	3	0.630	0.984	2.303	1.969	0.669	90°	CC..0602..
		A765 R3	2	0.630	0.984	2.303	1.969	0.768	90°	CC..0602..
	2.874-2.972	A765 R5	1	0.630	0.984	2.303	1.969	0.866	90°	CC..0602..
		A765 R2	3	0.630	0.984	2.303	1.969	0.717	90°	CC..0602..
	2.972-3.071	A765 R4	3	0.630	0.984	2.303	1.969	0.815	90°	CC..0602..
		A765 R6	2	0.630	0.984	2.303	1.969	0.913	90°	CC..0602..
	3.071-3.169	A765 R1	5	0.630	0.984	2.303	1.969	0.669	90°	CC..0602..
		A765 R3	4	0.630	0.984	2.303	1.969	0.768	90°	CC..0602..
	3.169-3.268	A765 R5	3	0.630	0.984	2.303	1.969	0.866	90°	CC..0602..
		A765 R2	5	0.630	0.984	2.303	1.969	0.717	90°	CC..0602..
	3.268-3.366	A765 R4	4	0.630	0.984	2.303	1.969	0.815	90°	CC..0602..
		A765 R6	3	0.630	0.984	2.303	1.969	0.913	90°	CC..0602..
	3.366-3.465	A765 R1	6	0.630	0.984	2.303	1.969	0.669	90°	CC..0602..
		A765 R3	5	0.630	0.984	2.303	1.969	0.768	90°	CC..0602..
	3.465-3.563	A765 R5	4	0.630	0.984	2.303	1.969	0.866	90°	CC..0602..
		A765 R2	6	0.630	0.984	2.303	1.969	0.717	90°	CC..0602..
	3.563-3.661	A765 R4	5	0.630	0.984	2.303	1.969	0.815	90°	CC..0602..
		A765 R6	4	0.630	0.984	2.303	1.969	0.913	90°	CC..0602..
	3.661-3.760	A765 R1	7	0.630	0.984	2.303	1.969	0.669	90°	CC..0602..
		A765 R3	6	0.630	0.984	2.303	1.969	0.768	90°	CC..0602..
	3.760-3.858	A765 R5	5	0.630	0.984	2.303	1.969	0.866	90°	CC..0602..
		A765 R2	7	0.630	0.984	2.303	1.969	0.717	90°	CC..0602..
	3.858-3.957	A765 R4	6	0.630	0.984	2.303	1.969	0.815	90°	CC..0602..
		A765 R6	5	0.630	0.984	2.303	1.969	0.913	90°	CC..0602..
	3.957-4.055	A765 R1	8	0.630	0.984	2.303	1.969	0.669	90°	CC..0602..
		A765 R3	7	0.630	0.984	2.303	1.969	0.768	90°	CC..0602..
	4.055-4.154	A765 R5	6	0.630	0.984	2.303	1.969	0.866	90°	CC..0602..
		A765 R2	8	0.630	0.984	2.303	1.969	0.717	90°	CC..0602..
	4.154-4.252	A765 R4	7	0.630	0.984	2.303	1.969	0.815	90°	CC..0602..
		A765 R6	8	0.630	0.984	2.303	1.969	0.913	90°	CC..0602..

Selezionare un portainserito idoneo, e considerare la posizione dello stelo sull'MPA per ottenere la capacità di barenatura richiesta.

Nota: Un'unità di barenatura richiede:

- una testa Axiabore™ Plus (A760 03)
- un MPA (BDA16BS25100)
- uno stelo (BAS25MH1660)
- un contrappeso (BAS25CW1660).
- un portainserito (A765R.) da scegliere nella tabella
- un inserto

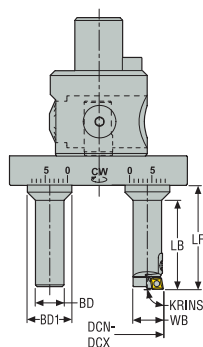

* + 0,2 mm (0.008") di capacità complementare raggiungibile.
Per la descrizione dettagliata dei portainseriti, vedere pagina(e) 624

Introduzione

Foratura

Alesatura

Barenatura

Allegato

Tabella di selezione:
 Portainseriti per tornitura esterna con MPA, per teste FB 760, In mm

	Capacità DCN-DCX Ø mm*	Portainserito Descrizione	Posizione del codolo	Dimensioni in mm					Angolo di attacco KRINS°	Dimensione inserto
				BD	BD1	LF	LB	WB		
	2-4,5	A765 R6	0	16	25	58,5	50	23,2	90°	CC..0602..
	4,5-7	A765 R5	0	16	25	58,5	50	22	90°	CC..0602..
	7-9,5	A765 R6	1	16	25	58,5	50	23,2	90°	CC..0602..
		A765 R4	0	16	25	58,5	50	20,7	90°	CC..0602..
	9,5-12	A765 R5	1	16	25	58,5	50	22	90°	CC..0602..
		A765 R3	0	16	25	58,5	50	19,5	90°	CC..0602..
	12-14,5	A765 R6	2	16	25	58,5	50	23,2	90°	CC..0602..
		A765 R4	1	16	25	58,5	50	20,7	90°	CC..0602..
	14,5-17	A765 R2	0	16	25	58,5	50	18,2	90°	CC..0602..
		A765 R5	2	16	25	58,5	50	22	90°	CC..0602..
	17-19,5	A765 R3	1	16	25	58,5	50	19,5	90°	CC..0602..
		A765 R1	0	16	25	58,5	50	17	90°	CC..0602..
	19,5-22	A765 R6	3	16	25	58,5	50	23,2	90°	CC..0602..
		A765 R4	2	16	25	58,5	50	20,7	90°	CC..0602..
	22-24,5	A765 R2	1	16	25	58,5	50	18,2	90°	CC..0602..
		A765 R5	3	16	25	58,5	50	22	90°	CC..0602..
	24,5-27	A765 R3	2	16	25	58,5	50	19,5	90°	CC..0602..
		A765 R1	1	16	25	58,5	50	17	90°	CC..0602..
	27-29,5	A765 R6	4	16	25	58,5	50	23,2	90°	CC..0602..
		A765 R4	3	16	25	58,5	50	20,7	90°	CC..0602..
	29,5-32	A765 R2	2	16	25	58,5	50	18,2	90°	CC..0602..
		A765 R5	3	16	25	58,5	50	22	90°	CC..0602..
	32-34,5	A765 R3	4	16	25	58,5	50	19,5	90°	CC..0602..
		A765 R1	3	16	25	58,5	50	17	90°	CC..0602..
	34,5-37	A765 R6	6	16	25	58,5	50	23,2	90°	CC..0602..
		A765 R4	5	16	25	58,5	50	20,7	90°	CC..0602..
	37-39,5	A765 R2	4	16	25	58,5	50	18,2	90°	CC..0602..
		A765 R5	6	16	25	58,5	50	22	90°	CC..0602..
	39,5-42	A765 R3	5	16	25	58,5	50	19,5	90°	CC..0602..
		A765 R1	4	16	25	58,5	50	17	90°	CC..0602..
	42-44,5	A765 R6	7	16	25	58,5	50	23,2	90°	CC..0602..
		A765 R4	6	16	25	58,5	50	20,7	90°	CC..0602..
	44,5-47	A765 R2	6	16	25	58,5	50	18,2	90°	CC..0602..
		A765 R5	8	16	25	58,5	50	22	90°	CC..0602..
	47-49,5	A765 R3	7	16	25	58,5	50	19,5	90°	CC..0602..
		A765 R1	6	16	25	58,5	50	17	90°	CC..0602..
	49,5-52	A765 R6	8	16	25	58,5	50	23,2	90°	CC..0602..
		A765 R4	7	16	25	58,5	50	20,7	90°	CC..0602..
	52-54,5	A765 R2	8	16	25	58,5	50	18,2	90°	CC..0602..
		A765 R5	7	16	25	58,5	50	22	90°	CC..0602..
	54,5-57	A765 R1	8	16	25	58,5	50	17	90°	CC..0602..

Selezionare un portainseriti adatto e prendere nota della posizione del codolo sull'MPA per ottenere la capacità di barenatura richiesta.
 Nota: Un assemblato di tornitura esterna richiede quanto segue:
 - una testa - Axiabore™ Plus - (A760 03)
 - un MPA (BDA16BS25100)
 - un codolo (BAS25MH1660)
 - un contrappeso (BAS25CW1660).
 - un portainseriti (A765R..) da selezionare nella tabella
 - un inserto

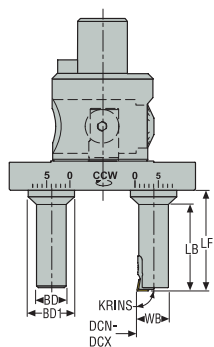

* + 0,2 mm (0.008") di capacità complementare raggiungibile.
 Per la descrizione dettagliata dei portainseriti, vedere pagina(e) 624

Introduzione

Foratura

Alesatura

Barenatura

Allegato

Tabella di selezione:
Portainseri per tornitura esterna con MPA, per teste FB 760, Pollici

	Capacità DCN-DCX Ø inch*	Portainsero Descrizione	Posizione del codolo	Dimensioni in pollici					Angolo di attacco KRINS°	Dimensione inserto
				BD	BD1	LF	LB	WB		
	0.079-0.177	A765 R6	0	0.630	0.984	2.303	1.969	0.913	90°	CC..0602..
	0.177-0.276	A765 R5	0	0.630	0.984	2.303	1.969	0.866	90°	CC..0602..
	0.276-0.374	A765 R6	1	0.630	0.984	2.303	1.969	0.913	90°	CC..0602..
		A765 R4	0	0.630	0.984	2.303	1.969	0.815	90°	CC..0602..
	0.374-0.472	A765 R5	1	0.630	0.984	2.303	1.969	0.866	90°	CC..0602..
		A765 R3	0	0.630	0.984	2.303	1.969	0.768	90°	CC..0602..
	0.472-0.571	A765 R6	2	0.630	0.984	2.303	1.969	0.913	90°	CC..0602..
		A765 R4	1	0.630	0.984	2.303	1.969	0.815	90°	CC..0602..
	0.571-0.669	A765 R2	0	0.630	0.984	2.303	1.969	0.717	90°	CC..0602..
		A765 R5	2	0.630	0.984	2.303	1.969	0.866	90°	CC..0602..
	0.669-0.768	A765 R3	1	0.630	0.984	2.303	1.969	0.768	90°	CC..0602..
		A765 R1	0	0.630	0.984	2.303	1.969	0.669	90°	CC..0602..
	0.768-0.866	A765 R6	3	0.630	0.984	2.303	1.969	0.913	90°	CC..0602..
		A765 R4	2	0.630	0.984	2.303	1.969	0.815	90°	CC..0602..
	0.866-0.965	A765 R2	1	0.630	0.984	2.303	1.969	0.717	90°	CC..0602..
		A765 R5	3	0.630	0.984	2.303	1.969	0.866	90°	CC..0602..
	0.965-1.063	A765 R3	2	0.630	0.984	2.303	1.969	0.768	90°	CC..0602..
		A765 R1	1	0.630	0.984	2.303	1.969	0.669	90°	CC..0602..
	1.063-1.161	A765 R6	4	0.630	0.984	2.303	1.969	0.913	90°	CC..0602..
		A765 R4	3	0.630	0.984	2.303	1.969	0.815	90°	CC..0602..
	1.161-1.260	A765 R2	3	0.630	0.984	2.303	1.969	0.717	90°	CC..0602..
		A765 R5	5	0.630	0.984	2.303	1.969	0.866	90°	CC..0602..
	1.260-1.358	A765 R3	4	0.630	0.984	2.303	1.969	0.768	90°	CC..0602..
		A765 R1	3	0.630	0.984	2.303	1.969	0.669	90°	CC..0602..
	1.358-1.457	A765 R6	6	0.630	0.984	2.303	1.969	0.913	90°	CC..0602..
		A765 R4	5	0.630	0.984	2.303	1.969	0.815	90°	CC..0602..
	1.457-1.555	A765 R2	4	0.630	0.984	2.303	1.969	0.717	90°	CC..0602..
		A765 R5	6	0.630	0.984	2.303	1.969	0.866	90°	CC..0602..
	1.555-1.654	A765 R3	5	0.630	0.984	2.303	1.969	0.768	90°	CC..0602..
		A765 R1	4	0.630	0.984	2.303	1.969	0.669	90°	CC..0602..
	1.654-1.654	A765 R6	7	0.630	0.984	2.303	1.969	0.913	90°	CC..0602..
		A765 R4	6	0.630	0.984	2.303	1.969	0.815	90°	CC..0602..
	1.654-1.850	A765 R2	6	0.630	0.984	2.303	1.969	0.717	90°	CC..0602..
		A765 R5	8	0.630	0.984	2.303	1.969	0.866	90°	CC..0602..
	1.850-1.949	A765 R3	7	0.630	0.984	2.303	1.969	0.768	90°	CC..0602..
		A765 R1	6	0.630	0.984	2.303	1.969	0.669	90°	CC..0602..
	1.949-2.047	A765 R4	8	0.630	0.984	2.303	1.969	0.815	90°	CC..0602..
		A765 R2	7	0.630	0.984	2.303	1.969	0.717	90°	CC..0602..
	2.047-2.146	A765 R3	8	0.630	0.984	2.303	1.969	0.768	90°	CC..0602..
		A765 R1	7	0.630	0.984	2.303	1.969	0.669	90°	CC..0602..
	2.146-2.244	A765 R2	8	0.630	0.984	2.303	1.969	0.717	90°	CC..0602..
		A765 R1	8	0.630	0.984	2.303	1.969	0.669	90°	CC..0602..

Selezionare un portainseri adatto e prendere nota della posizione del codolo sull'MPA per ottenere la capacità di barenatura richiesta.

Nota: Un assemblato di tornitura esterna richiede quanto segue:

- una testa - Axiabore™ Plus - (A760 03)
- un MPA (BDA16BS25100)
- un codolo (BAS25MH1660)
- un contrappeso (BAS25CW1660).
- un portainseri (A765R..) da selezionare nella tabella
- un inserto

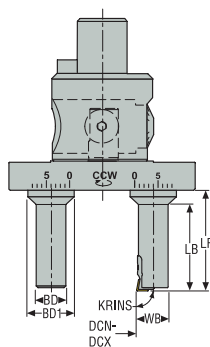

* + 0,2 mm (0.008") di capacità complementare raggiungibile.
Per la descrizione dettagliata dei portainseri, vedere pagina(e) 624

Introduzione

Foratura

Alesatura

Barenatura

Allegato

Tabella di selezione:

Utensile per scanalatura - su centraggio - per scanalatura con MPA, per teste FB 760, In mm

Introduzione

Foratura

Alesatura

Barenatura

Allegato

	Capacità DCN-DCX Ø mm*	Utensile di scanalatura contro il centraggio Descrizione	Posizione portautensili per scanalatura**	Disegno	Dimensioni in mm						Prof. max. scanalatura CDX	
					BD	CW	LF	LB	WF	RE		
Configurazione 1 	19-24	AFG0629 10 1582	0-I	1	25	1	34	18	2,95	0,15	2,0	
	24-29		1-I	1	25	1	34	18	2,95	0,15	2,0	
	29-34		2-I	1	25	1	34	18	2,95	0,15	2,0	
	34-39		3-I	1	25	1	34	18	2,95	0,15	2,0	
	39-44		0-E / 4-I	1/2	25	1	34	18	2,95	0,15	2,0	
	44-49		1-E / 5-I	1/2	25	1	34	18	2,95	0,15	2,0	
	49-54		2-E / 6-I	1/2	25	1	34	18	2,95	0,15	2,0	
	54-59		3-E / 7-I	1/2	25	1	34	18	2,95	0,15	2,0	
	59-64		4-E / 8-I	1/2	25	1	34	18	2,95	0,15	2,0	
	64-69		5-E	2	25	1	34	18	2,95	0,15	2,0	
Configurazione 2 	69-74	AFG0629 15 1582	6-E	2	25	1	34	18	2,95	0,15	2,0	
	74-79		7-E	2	25	1	34	18	2,95	0,15	2,0	
	79-84		8-E	2	25	1	34	18	2,95	0,15	2,0	
	19-24		AFG0629 20 1582	0-I	1	25	1,5	34	18	2,95	0,15	3,0
	24-29			1-I	1	25	1,5	34	18	2,95	0,15	3,0
	29-34			2-I	1	25	1,5	34	18	2,95	0,15	3,0
	34-39			3-I	1	25	1,5	34	18	2,95	0,15	3,0
	39-44			0-E / 4-I	1/2	25	1,5	34	18	2,95	0,15	3,0
	44-49			1-E / 5-I	1/2	25	1,5	34	18	2,95	0,15	3,0
	49-54			2-E / 6-I	1/2	25	1,5	34	18	2,95	0,15	3,0
54-59	3-E / 7-I	1/2		25	1,5	34	18	2,95	0,15	3,0		
59-64	4-E / 8-I	1/2		25	1,5	34	18	2,95	0,15	3,0		
64-69	5-E	2		25	1,5	34	18	2,95	0,15	3,0		
Configurazione 3 	69-74	AFG0629 20 1582	6-E	2	25	1,5	34	18	2,95	0,15	3,0	
	74-79		7-E	2	25	1,5	34	18	2,95	0,15	3,0	
	79-84		8-E	2	25	1,5	34	18	2,95	0,15	3,0	
	19-24		AFG0629 20 1582	0-I	1	25	2	34	18	2,95	0,15	4,0
	24-29			1-I	1	25	2	34	18	2,95	0,15	4,0
	29-34			2-I	1	25	2	34	18	2,95	0,15	4,0
	34-39			3-I	1	25	2	34	18	2,95	0,15	4,0
	39-44			0-E / 4-I	1/2	25	2	34	18	2,95	0,15	4,0
	44-49			1-E / 5-I	1/2	25	2	34	18	2,95	0,15	4,0
	49-54			2-E / 6-I	1/2	25	2	34	18	2,95	0,15	4,0
54-59	3-E / 7-I	1/2		25	2	34	18	2,95	0,15	4,0		
59-64	4-E / 8-I	1/2		25	2	34	18	2,95	0,15	4,0		
64-69	5-E	2		25	2	34	18	2,95	0,15	4,0		
69-74	6-E	2	25	2	34	18	2,95	0,15	4,0			
74-79	7-E	2	25	2	34	18	2,95	0,15	4,0			
79-84	8-E	2	25	2	34	18	2,95	0,15	4,0			

* Capacità complementare raggiungibile di +0,2 mm (0,008"). ** Valori consigliati in grassetto.
 Descrizione dettagliata degli utensili per scanalatura, vedere le pagine 629

Tabella di selezione:

Utensile per scanalatura - su centraggio - per scanalatura con MPA, per teste FB 760, In mm

	Configurazione 1		Configurazione 2		Dimensioni in mm							Prof. max. scanalatura CDX
	Capacità DCN-DCX Ø mm*	Utensile di scanalatura contro il centraggio Descrizione	Posizione portautensili per scanalatura**	Disegno	BD	CW	LF	LB	WF	RE		
Selezione l'utensile per scanalatura adatto e prendere nota della posizione del portautensili per scanalatura sull'MPA per ottenere la capacità di scanalatura richiesta.	19-24	AFG0629 25 1582	0-I	1	25	2,5	34	18	2,95	0,15	5,0	
	24-29		1-I	1	25	2,5	34	18	2,95	0,15	5,0	
	29-34		2-I	1	25	2,5	34	18	2,95	0,15	5,0	
	34-39		3-I	1	25	2,5	34	18	2,95	0,15	5,0	
	39-44		0-E / 4-I	1/2	25	2,5	34	18	2,95	0,15	5,0	
	44-49		1-E / 5-I	1/2	25	2,5	34	18	2,95	0,15	5,0	
	49-54		2-E / 6-I	1/2	25	2,5	34	18	2,95	0,15	5,0	
	54-59		3-E / 7-I	1/2	25	2,5	34	18	2,95	0,15	5,0	
	59-64		4-E / 8-I	1/2	25	2,5	34	18	2,95	0,15	5,0	
	64-69		5-E	2	25	2,5	34	18	2,95	0,15	5,0	
69-74	6-E	2	25	2,5	34	18	2,95	0,15	5,0			
74-79	7-E	2	25	2,5	34	18	2,95	0,15	5,0			
79-84	8-E	2	25	2,5	34	18	2,95	0,15	5,0			
Nota: Un assemblato -contro il centraggio- richiede quanto segue: <ul style="list-style-type: none"> • una testa - Axiabore™ Plus - (A760 03) • un MPA (BDA16BS25100) • un utensile di scanalatura I (posizione interna) BAS25FGI35 e un utensile E (posizione esterna) BAS25FGE35 per tenere un utensile di scanalatura o agire da contrappeso (vedere la posizione di regolazione nella tabella) • un utensile per scanalatura -contro il centraggio- (AFG...82) da selezionare nella tabella, in relazione alla larghezza e al diametro della scanalatura. 	19-24	AFG0629 30 1582	0-I	1	25	3	34	18	2,95	0,15	6,0	
	24-29		1-I	1	25	3	34	18	2,95	0,15	6,0	
	29-34		2-I	1	25	3	34	18	2,95	0,15	6,0	
	34-39		3-I	1	25	3	34	18	2,95	0,15	6,0	
	39-44		0-E / 4-I	1/2	25	3	34	18	2,95	0,15	6,0	
	44-49		1-E / 5-I	1/2	25	3	34	18	2,95	0,15	6,0	
	49-54		2-E / 6-I	1/2	25	3	34	18	2,95	0,15	6,0	
	54-59		3-E / 7-I	1/2	25	3	34	18	2,95	0,15	6,0	
	59-64		4-E / 8-I	1/2	25	3	34	18	2,95	0,15	6,0	
	64-69		5-E	2	25	3	34	18	2,95	0,15	6,0	
69-74	6-E	2	25	3	34	18	2,95	0,15	6,0			
74-79	7-E	2	25	3	34	18	2,95	0,15	6,0			
79-84	8-E	2	25	3	34	18	2,95	0,15	6,0			

* Capacità complementare raggiungibile di +0,2 mm (0,008"). ** Valori consigliati in grassetto. Descrizione dettagliata degli utensili per scanalatura, vedere le pagine 629

Tabella di selezione:

Utensile per scanalatura - su centraggio - per scanalatura con MPA, per teste FB 760, Pollici

Introduzione

Foratura

Alesatura

Barenatura

Allegato

	Capacità DCN-DCX Ø inch*	Utensile di scanalatura contro il centraggio Descrizione	Posizione portautensili per scanalatura**	Disegno	Dimensioni in pollici						Prof. max. scanalatura CDX
					BD	CW	LF	LB	WF	RE	
<p>Configurazione 1</p> <p>Configurazione 2</p>	0.748-0.945	AFG0629 10 1582	0-I	1	0.984	0.0394	1.339	0.709	0.116	0.006	0.079
	0.945-1.142		1-I	1	0.984	0.0394	1.339	0.709	0.116	0.006	0.079
	1.142-1.339		2-I	1	0.984	0.0394	1.339	0.709	0.116	0.006	0.079
	1.339-1.535		3-I	1	0.984	0.0394	1.339	0.709	0.116	0.006	0.079
	1.535-1.732		0-E / 4-I	1/2	0.984	0.0394	1.339	0.709	0.116	0.006	0.079
	1.732-1.929		1-E / 5-I	1/2	0.984	0.0394	1.339	0.709	0.116	0.006	0.079
	1.929-2.126		2-E / 6-I	1/2	0.984	0.0394	1.339	0.709	0.116	0.006	0.079
	2.126-2.323		3-E / 7-I	1/2	0.984	0.0394	1.339	0.709	0.116	0.006	0.079
	2.323-2.520		4-E / 8-I	1/2	0.984	0.0394	1.339	0.709	0.116	0.006	0.079
	2.520-2.717		5-E	2	0.984	0.0394	1.339	0.709	0.116	0.006	0.079
2.717-2.913	6-E	2	0.984	0.0394	1.339	0.709	0.116	0.006	0.079		
2.913-3.110	7-E	2	0.984	0.0394	1.339	0.709	0.116	0.006	0.079		
3.110-3.307	8-E	2	0.984	0.0394	1.339	0.709	0.116	0.006	0.079		
<p>Configurazione 2</p>	0.748-0.945	AFG0629 15 1582	0-I	1	0.984	0.0591	1.339	0.709	0.116	0.006	0.118
	0.945-1.142		1-I	1	0.984	0.0591	1.339	0.709	0.116	0.006	0.118
	1.142-1.339		2-I	1	0.984	0.0591	1.339	0.709	0.116	0.006	0.118
	1.339-1.535		3-I	1	0.984	0.0591	1.339	0.709	0.116	0.006	0.118
	1.535-1.732		0-E / 4-I	1/2	0.984	0.0591	1.339	0.709	0.116	0.006	0.118
	1.732-1.929		1-E / 5-I	1/2	0.984	0.0591	1.339	0.709	0.116	0.006	0.118
	1.929-2.126		2-E / 6-I	1/2	0.984	0.0591	1.339	0.709	0.116	0.006	0.118
	2.126-2.323		3-E / 7-I	1/2	0.984	0.0591	1.339	0.709	0.116	0.006	0.118
	2.323-2.520		4-E / 8-I	1/2	0.984	0.0591	1.339	0.709	0.116	0.006	0.118
	2.520-2.717		5-E	2	0.984	0.0591	1.339	0.709	0.116	0.006	0.118
2.717-2.913	6-E	2	0.984	0.0591	1.339	0.709	0.116	0.006	0.118		
2.913-3.110	7-E	2	0.984	0.0591	1.339	0.709	0.116	0.006	0.118		
3.110-3.307	8-E	2	0.984	0.0591	1.339	0.709	0.116	0.006	0.118		
<p>Configurazione 3</p>	0.748-0.945	AFG0629 20 1582	0-I	1	0.984	0.0787	1.339	0.709	0.116	0.006	0.157
	0.945-1.142		1-I	1	0.984	0.0787	1.339	0.709	0.116	0.006	0.157
	1.142-1.339		2-I	1	0.984	0.0787	1.339	0.709	0.116	0.006	0.157
	1.339-1.535		3-I	1	0.984	0.0787	1.339	0.709	0.116	0.006	0.157
	1.535-1.732		0-E / 4-I	1/2	0.984	0.0787	1.339	0.709	0.116	0.006	0.157
	1.732-1.929		1-E / 5-I	1/2	0.984	0.0787	1.339	0.709	0.116	0.006	0.157
	1.929-2.126		2-E / 6-I	1/2	0.984	0.0787	1.339	0.709	0.116	0.006	0.157
	2.126-2.323		3-E / 7-I	1/2	0.984	0.0787	1.339	0.709	0.116	0.006	0.157
	2.323-2.520		4-E / 8-I	1/2	0.984	0.0787	1.339	0.709	0.116	0.006	0.157
	2.520-2.717		5-E	2	0.984	0.0787	1.339	0.709	0.116	0.006	0.157
2.717-2.913	6-E	2	0.984	0.0787	1.339	0.709	0.116	0.006	0.157		
2.913-3.110	7-E	2	0.984	0.0787	1.339	0.709	0.116	0.006	0.157		
3.110-3.307	8-E	2	0.984	0.0787	1.339	0.709	0.116	0.006	0.157		

* Capacità complementare raggiungibile di +0,2 mm (0,008"). ** Valori consigliati in grassetto.
 Descrizione dettagliata degli utensili per scanalatura, vedere le pagine 629

Tabella di selezione:
 Utensile per scanalatura - su centraggio - per scanalatura con MPA, per teste FB 760,
 Pollici

	Capacità DCN-DCX Ø inch*	Utensile di scanalatura contro il centraggio Descrizione	Posizione portautensili per scanalatura**	Disegno	Dimensioni in pollici						Prof. max. scanalatura CDX
					BD	CW	LF	LB	WF	RE	
Configurazione 1 	0.748-0.945	AFG0629 25 1582	0-I	1	0.984	0.0984	1.339	0.709	0.116	0.006	0.197
	0.945-1.142		1-I	1	0.984	0.0984	1.339	0.709	0.116	0.006	0.197
	1.142-1.339		2-I	1	0.984	0.0984	1.339	0.709	0.116	0.006	0.197
	1.339-1.535		3-I	1	0.984	0.0984	1.339	0.709	0.116	0.006	0.197
	1.535-1.732		0-E / 4-I	1/2	0.984	0.0984	1.339	0.709	0.116	0.006	0.197
	1.732-1.929		1-E / 5-I	1/2	0.984	0.0984	1.339	0.709	0.116	0.006	0.197
	1.929-2.126		2-E / 6-I	1/2	0.984	0.0984	1.339	0.709	0.116	0.006	0.197
	2.126-2.323		3-E / 7-I	1/2	0.984	0.0984	1.339	0.709	0.116	0.006	0.197
	2.323-2.520		4-E / 8-I	1/2	0.984	0.0984	1.339	0.709	0.116	0.006	0.197
	2.520-2.717		5-E	2	0.984	0.0984	1.339	0.709	0.116	0.006	0.197
2.717-2.913	6-E	2	0.984	0.0984	1.339	0.709	0.116	0.006	0.197		
2.913-3.110	7-E	2	0.984	0.0984	1.339	0.709	0.116	0.006	0.197		
3.110-3.307	8-E	2	0.984	0.0984	1.339	0.709	0.116	0.006	0.197		
Configurazione 2 	0.748-0.945	AFG0629 30 1582	0-I	1	0.984	0.1181	1.339	0.709	0.116	0.006	0.236
	0.945-1.142		1-I	1	0.984	0.1181	1.339	0.709	0.116	0.006	0.236
	1.142-1.339		2-I	1	0.984	0.1181	1.339	0.709	0.116	0.006	0.236
	1.339-1.535		3-I	1	0.984	0.1181	1.339	0.709	0.116	0.006	0.236
	1.535-1.732		0-E / 4-I	1/2	0.984	0.1181	1.339	0.709	0.116	0.006	0.236
	1.732-1.929		1-E / 5-I	1/2	0.984	0.1181	1.339	0.709	0.116	0.006	0.236
	1.929-2.126		2-E / 6-I	1/2	0.984	0.1181	1.339	0.709	0.116	0.006	0.236
	2.126-2.323		3-E / 7-I	1/2	0.984	0.1181	1.339	0.709	0.116	0.006	0.236
	2.323-2.520		4-E / 8-I	1/2	0.984	0.1181	1.339	0.709	0.116	0.006	0.236
	2.520-2.717		5-E	2	0.984	0.1181	1.339	0.709	0.116	0.006	0.236
2.717-2.913	6-E	2	0.984	0.1181	1.339	0.709	0.116	0.006	0.236		
2.913-3.110	7-E	2	0.984	0.1181	1.339	0.709	0.116	0.006	0.236		
3.110-3.307	8-E	2	0.984	0.1181	1.339	0.709	0.116	0.006	0.236		

Nota: Un assemblato -contro il centraggio- richiede quanto segue:

- una testa - Axiabore™ Plus - (A760 03)
- un MPA (BDA16BS25100)
- un utensile di scanalatura I (posizione interna) BAS25FGI35 e un utensile E (posizione esterna) BAS25FGE35 per tenere un utensile di scanalatura o agire da contrappeso (vedere la posizione di regolazione nella tabella)
- un utensile per scanalatura -contro il centraggio- (AFG...82) da selezionare nella tabella, in relazione alla larghezza e al diametro della scanalatura.

* Capacità complementare raggiungibile di +0,2 mm (0,008"). ** Valori consigliati in grassetto.
 Descrizione dettagliata degli utensili per scanalatura, vedere le pagine 629

Tabella di selezione:

Utensile per scanalatura - contro il foro - per scanalatura con MPA, per teste FB 760, In mm

Introduzione

Foratura

Alesatura

Barenatura

Allegato

	Capacità DCN-DCX Ø mm*	Utensile di scanalatura contro il foro Descrizione	Posizione portautensili per scanalatura**	Disegno	Dimensioni in mm						Prof. max. scanalatura CDX	
					BD	CW	LF	LB	WF	RE		
Configurazione 3 	31-36	AFG0629 10 1581	0-I	3	25	1	34	18	2,95	0,15	2,0	
	36-41		1-I	3	25	1	34	18	2,95	0,15	2,0	
	41-46		2-I	3	25	1	34	18	2,95	0,15	2,0	
	46-51		3-I	3	25	1	34	18	2,95	0,15	2,0	
	51-56		0-E / 4-I	3/4	25	1	34	18	2,95	0,15	2,0	
	56-61		1-E / 5-I	3/4	25	1	34	18	2,95	0,15	2,0	
	61-66		2-E / 6-I	3/4	25	1	34	18	2,95	0,15	2,0	
	66-71		3-E / 7-I	3/4	25	1	34	18	2,95	0,15	2,0	
	71-76		4-E / 8-I	3/4	25	1	34	18	2,95	0,15	2,0	
	76-81		5-E	4	25	1	34	18	2,95	0,15	2,0	
Configurazione 4 	81-86	AFG0629 15 1581	6-E	4	25	1	34	18	2,95	0,15	2,0	
	86-91		7-E	4	25	1	34	18	2,95	0,15	2,0	
	91-96		8-E	4	25	1	34	18	2,95	0,15	2,0	
	31-36		AFG0629 20 1581	0-I	3	25	1,5	34	18	2,95	0,15	3,0
	39-41			1-I	3	25	1,5	34	18	2,95	0,15	3,0
	41-46			2-I	3	25	1,5	34	18	2,95	0,15	3,0
	46-51			3-I	3	25	1,5	34	18	2,95	0,15	3,0
	51-56			0-E / 4-I	3/4	25	1,5	34	18	2,95	0,15	3,0
	56-61			1-E / 5-I	3/4	25	1,5	34	18	2,95	0,15	3,0
	61-66			2-E / 6-I	3/4	25	1,5	34	18	2,95	0,15	3,0
66-71	3-E / 7-I	3/4		25	1,5	34	18	2,95	0,15	3,0		
71-76	4-E / 8-I	3/4		25	1,5	34	18	2,95	0,15	3,0		
76-81	5-E	4		25	1,5	34	18	2,95	0,15	3,0		
Nota: Un assemblato di scanalatura -contro il centraggio- richiede quanto segue: • una testa Axiabore™ Plus (A760 03) • un MPA (BDA16BS25100) • un utensile di scanalatura I (posizione interna) ed un utensile E (posizione esterna) (BAS25FGI35 e BAS25FGE35) per tenere l'utensile di scanalatura o agire da contrappeso (vedere posizione di regolazione in tabella) • un utensile di scanalatura contro il foro (AFG...81) da selezionare nella tabella, in relazione alla larghezza della scanalatura e al diametro.	81-86	AFG0629 20 1581	6-E	4	25	1,5	34	18	2,95	0,15	3,0	
	86-91		7-E	4	25	1,5	34	18	2,95	0,15	3,0	
	91-96		8-E	4	25	1,5	34	18	2,95	0,15	3,0	
	31-36		AFG0629 20 1581	0-I	3	25	2	34	18	2,95	0,15	4,0
	39-41			1-I	3	25	2	34	18	2,95	0,15	4,0
	41-46			2-I	3	25	2	34	18	2,95	0,15	4,0
	46-51			3-I	3	25	2	34	18	2,95	0,15	4,0
	51-56			0-E / 4-I	3/4	25	2	34	18	2,95	0,15	4,0
	56-61			1-E / 5-I	3/4	25	2	34	18	2,95	0,15	4,0
	61-66			2-E / 6-I	3/4	25	2	34	18	2,95	0,15	4,0
66-71	3-E / 7-I	3/4		25	2	34	18	2,95	0,15	4,0		
71-76	4-E / 8-I	3/4		25	2	34	18	2,95	0,15	4,0		
76-81	5-E	4		25	2	34	18	2,95	0,15	4,0		
81-86	6-E	4	25	2	34	18	2,95	0,15	4,0			
86-91	7-E	4	25	2	34	18	2,95	0,15	4,0			
91-96	8-E	4	25	2	34	18	2,95	0,15	4,0			

* Capacità complementare raggiungibile di +0,2 mm (0,008"). ** Valori consigliati in grassetto.
 Descrizione dettagliata degli utensili per scanalatura, vedere le pagine 629

Tabella di selezione:

Utensile per scanalatura - contro il foro - per scanalatura con MPA, per teste FB 760, In mm

Configurazione 3

Configurazione 4

	Capacità DCN-DCX Ø mm*	Utensile di scanalatura contro il foro Descrizione	Posizione portautensili per scanalatura**	Disegno	Dimensioni in mm						Prof. max. scanalatura CDX
					BD	CW	LF	LB	WF	RE	
Selezione l'utensile per scanalatura adatto e prendere nota della posizione del portautensili per scanalatura sull'MPA per ottenere la capacità di scanalatura richiesta. 	31-36	AFG0629 25 1581	0-I	3	25	2,5	34	18	2,95	0,15	5,0
	36-41		1-I	3	25	2,5	34	18	2,95	0,15	5,0
	41-46		2-I	3	25	2,5	34	18	2,95	0,15	5,0
	46-51		3-I	3	25	2,5	34	18	2,95	0,15	5,0
	51-56		0-E / 4-I	3/4	25	2,5	34	18	2,95	0,15	5,0
	56-61		1-E / 5-I	3/4	25	2,5	34	18	2,95	0,15	5,0
	61-66		2-E / 6-I	3/4	25	2,5	34	18	2,95	0,15	5,0
	66-71		3-E / 7-I	3/4	25	2,5	34	18	2,95	0,15	5,0
	71-76		4-E / 8-I	3/4	25	2,5	34	18	2,95	0,15	5,0
	76-81		5-E	4	25	2,5	34	18	2,95	0,15	5,0
81-86	6-E	4	25	2,5	34	18	2,95	0,15	5,0		
86-91	7-E	4	25	2,5	34	18	2,95	0,15	5,0		
91-96	8-E	4	25	2,5	34	18	2,95	0,15	5,0		
Nota: Un assemblato di scanalatura -contro il centraggio- richiede quanto segue: • una testa Axiabore™ Plus (A760 03) • un MPA (BDA16BS25100) • un utensile di scanalatura I (posizione interna) ed un utensile E (posizione esterna) (BAS25FGI35 e BAS25FGE35) per tenere l'utensile di scanalatura o agire da contrappeso (vedere posizione di regolazione in tabella) • un utensile di scanalatura contro il foro (AFG...81) da selezionare nella tabella, in relazione alla larghezza della scanalatura e al diametro.	31-36	AFG0629 30 1581	0-I	3	25	3	34	18	2,95	0,15	6,0
	39-41		1-I	3	25	3	34	18	2,95	0,15	6,0
	41-46		2-I	3	25	3	34	18	2,95	0,15	6,0
	46-51		3-I	3	25	3	34	18	2,95	0,15	6,0
	51-56		0-E / 4-I	3/4	25	3	34	18	2,95	0,15	6,0
	56-61		1-E / 5-I	3/4	25	3	34	18	2,95	0,15	6,0
	61-66		2-E / 6-I	3/4	25	3	34	18	2,95	0,15	6,0
	66-71		3-E / 7-I	3/4	25	3	34	18	2,95	0,15	6,0
	71-76		4-E / 8-I	3/4	25	3	34	18	2,95	0,15	6,0
	76-81		5-E	4	25	3	34	18	2,95	0,15	6,0
81-86	6-E	4	25	3	34	18	2,95	0,15	6,0		
86-91	7-E	4	25	3	34	18	2,95	0,15	6,0		
91-96	8-E	4	25	3	34	18	2,95	0,15	6,0		

* Capacità complementare raggiungibile di +0,2 mm (0,008"). ** Valori consigliati in grassetto. Descrizione dettagliata degli utensili per scanalatura, vedere le pagine 629

Tabella di selezione:
 Utensile per scanalatura - contro il foro - per scanalatura con MPA, per teste FB 760,
 Pollici

Introduzione

Foratura

Alesatura

Barenatura

Allegato

	Capacità DCN-DCX Ø inch*	Utensile di scanalatura contro il foro Descrizione	Posizione portautensili per scanalatura**	Disegno	Dimensioni in pollici						Prof. max. scanalatura CDX		
					BD	CW	LF	LB	WF	RE			
Configurazione 3 	1.220-1.417	AFG0629 10 1581	0-I	3	0.984	0.0394	1.339	0.709	0.116	0.006	0.079		
	1.417-1.614		1-I	3	0.984	0.0394	1.339	0.709	0.116	0.006	0.079		
	1.614-1.811		2-I	3	0.984	0.0394	1.339	0.709	0.116	0.006	0.079		
	1.811-2.008		3-I	3	0.984	0.0394	1.339	0.709	0.116	0.006	0.079		
	2.008-2.205		0-E / 4-I	3/4	0.984	0.0394	1.339	0.709	0.116	0.006	0.079		
	2.205-2.402		1-E / 5-I	3/4	0.984	0.0394	1.339	0.709	0.116	0.006	0.079		
	2.402-2.598		2-E / 6-I	3/4	0.984	0.0394	1.339	0.709	0.116	0.006	0.079		
	2.598-2.795		3-E / 7-I	3/4	0.984	0.0394	1.339	0.709	0.116	0.006	0.079		
	2.795-2.992		4-E / 8-I	3/4	0.984	0.0394	1.339	0.709	0.116	0.006	0.079		
	2.992-3.189		5-E	4	0.984	0.0394	1.339	0.709	0.116	0.006	0.079		
	3.189-3.386		6-E	4	0.984	0.0394	1.339	0.709	0.116	0.006	0.079		
	3.386-3.583		7-E	4	0.984	0.0394	1.339	0.709	0.116	0.006	0.079		
	3.583-3.780		8-E	4	0.984	0.0394	1.339	0.709	0.116	0.006	0.079		
	Configurazione 4 		1.220-1.417	AFG0629 15 1581	0-I	3	0.984	0.0591	1.339	0.709	0.116	0.006	0.118
			1.417-1.614		1-I	3	0.984	0.0591	1.339	0.709	0.116	0.006	0.118
			1.614-1.811		2-I	3	0.984	0.0591	1.339	0.709	0.116	0.006	0.118
1.811-2.008		3-I	3		0.984	0.0591	1.339	0.709	0.116	0.006	0.118		
2.008-2.205		0-E / 4-I	3/4		0.984	0.0591	1.339	0.709	0.116	0.006	0.118		
2.205-2.402		1-E / 5-I	3/4		0.984	0.0591	1.339	0.709	0.116	0.006	0.118		
2.402-2.598		2-E / 6-I	3/4		0.984	0.0591	1.339	0.709	0.116	0.006	0.118		
2.598-2.795		3-E / 7-I	3/4		0.984	0.0591	1.339	0.709	0.116	0.006	0.118		
2.795-2.992		4-E / 8-I	3/4		0.984	0.0591	1.339	0.709	0.116	0.006	0.118		
2.992-3.189		5-E	4		0.984	0.0591	1.339	0.709	0.116	0.006	0.118		
3.189-3.386		6-E	4		0.984	0.0591	1.339	0.709	0.116	0.006	0.118		
3.386-3.583		7-E	4		0.984	0.0591	1.339	0.709	0.116	0.006	0.118		
3.583-3.780		8-E	4		0.984	0.0591	1.339	0.709	0.116	0.006	0.118		
Configurazione 3 		1.220-1.417	AFG0629 20 1581		0-I	3	0.984	0.0787	1.339	0.709	0.116	0.006	0.157
		1.417-1.614			1-I	3	0.984	0.0787	1.339	0.709	0.116	0.006	0.157
		1.614-1.811			2-I	3	0.984	0.0787	1.339	0.709	0.116	0.006	0.157
	1.811-2.008	3-I		3	0.984	0.0787	1.339	0.709	0.116	0.006	0.157		
	2.008-2.205	0-E / 4-I		3/4	0.984	0.0787	1.339	0.709	0.116	0.006	0.157		
	2.205-2.402	1-E / 5-I		3/4	0.984	0.0787	1.339	0.709	0.116	0.006	0.157		
	2.402-2.598	2-E / 6-I		3/4	0.984	0.0787	1.339	0.709	0.116	0.006	0.157		
	2.598-2.795	3-E / 7-I		3/4	0.984	0.0787	1.339	0.709	0.116	0.006	0.157		
	2.795-2.992	4-E / 8-I		3/4	0.984	0.0787	1.339	0.709	0.116	0.006	0.157		
	2.992-3.189	5-E		4	0.984	0.0787	1.339	0.709	0.116	0.006	0.157		
	3.189-3.386	6-E		4	0.984	0.0787	1.339	0.709	0.116	0.006	0.157		
	3.386-3.583	7-E		4	0.984	0.0787	1.339	0.709	0.116	0.006	0.157		
	3.583-3.780	8-E		4	0.984	0.0787	1.339	0.709	0.116	0.006	0.157		

* Capacità complementare raggiungibile di +0,2 mm (0,008"). ** Valori consigliati in grassetto.
 Descrizione dettagliata degli utensili per scanalatura, vedere le pagine 629

Tabella di selezione:

Utensile per scanalatura - contro il foro - per scanalatura con MPA, per teste FB 760, Pollici

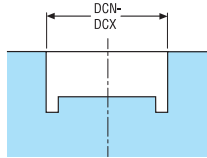
	Capacità DCN-DCX Ø inch*	Utensile di scanalatura contro il foro Descrizione	Posizione portautensili per scanalatura**	Disegno	Dimensioni in pollici						Prof. max. scanalatura CDX
					BD	CW	LF	LB	WF	RE	
<p>Selezionare l'utensile per scanalatura adatto e prendere nota della posizione del portautensili per scanalatura sull'MPA per ottenere la capacità di scanalatura richiesta.</p> 	1.220-1.417	AFG0629 25 1581	0-I	3	0.984	0.0984	1.339	0.709	0.116	0.006	0.197
	1.417-1.614		1-I	3	0.984	0.0984	1.339	0.709	0.116	0.006	0.197
	1.614-1.811		2-I	3	0.984	0.0984	1.339	0.709	0.116	0.006	0.197
	1.811-2.008		3-I	3	0.984	0.0984	1.339	0.709	0.116	0.006	0.197
	2.008-2.205		0-E / 4-I	3/4	0.984	0.0984	1.339	0.709	0.116	0.006	0.197
	2.205-2.402		1-E / 5-I	3/4	0.984	0.0984	1.339	0.709	0.116	0.006	0.197
	2.402-2.598		2-E / 6-I	3/4	0.984	0.0984	1.339	0.709	0.116	0.006	0.197
	2.598-2.795		3-E / 7-I	3/4	0.984	0.0984	1.339	0.709	0.116	0.006	0.197
	2.795-2.992		4-E / 8-I	3/4	0.984	0.0984	1.339	0.709	0.116	0.006	0.197
	2.992-3.189		5-E	4	0.984	0.0984	1.339	0.709	0.116	0.006	0.197
	3.189-3.386		6-E	4	0.984	0.0984	1.339	0.709	0.116	0.006	0.197
	3.386-3.583		7-E	4	0.984	0.0984	1.339	0.709	0.116	0.006	0.197
	3.583-3.780		8-E	4	0.984	0.0984	1.339	0.709	0.116	0.006	0.197
<p>Nota: Un assemblato di scanalatura -contro il centraggio- richiede quanto segue:</p> <ul style="list-style-type: none"> • una testa Axiabore™ Plus (A760 03) • un MPA (BDA16BS25100) • un utensile di scanalatura I (posizione interna) ed un utensile E (posizione esterna) (BAS25FGI35 e BAS25FGE35) per tenere l'utensile di scanalatura o agire da contrappeso (vedere posizione di regolazione in tabella) • un utensile di scanalatura contro il foro (AFG...81) da selezionare nella tabella, in relazione alla larghezza della scanalatura e al diametro. 	1.220-1.417	AFG0629 30 1581	0-I	3	0.984	0.1181	1.339	0.709	0.116	0.006	0.236
	1.417-1.614		1-I	3	0.984	0.1181	1.339	0.709	0.116	0.006	0.236
	1.614-1.811		2-I	3	0.984	0.1181	1.339	0.709	0.116	0.006	0.236
	1.811-2.008		3-I	3	0.984	0.1181	1.339	0.709	0.116	0.006	0.236
	2.008-2.205		0-E / 4-I	3/4	0.984	0.1181	1.339	0.709	0.116	0.006	0.236
	2.205-2.402		1-E / 5-I	3/4	0.984	0.1181	1.339	0.709	0.116	0.006	0.236
	2.402-2.598		2-E / 6-I	3/4	0.984	0.1181	1.339	0.709	0.116	0.006	0.236
	2.598-2.795		3-E / 7-I	3/4	0.984	0.1181	1.339	0.709	0.116	0.006	0.236
	2.795-2.992		4-E / 8-I	3/4	0.984	0.1181	1.339	0.709	0.116	0.006	0.236
	2.992-3.189		5-E	4	0.984	0.1181	1.339	0.709	0.116	0.006	0.236
	3.189-3.386		6-E	4	0.984	0.1181	1.339	0.709	0.116	0.006	0.236
	3.386-3.583		7-E	4	0.984	0.1181	1.339	0.709	0.116	0.006	0.236
	3.583-3.780		8-E	4	0.984	0.1181	1.339	0.709	0.116	0.006	0.236

* Capacità complementare raggiungibile di +0,2 mm (0,008"). ** Valori consigliati in grassetto. Descrizione dettagliata degli utensili per scanalatura, vedere le pagine 629

Istruzioni

Velocità massime per testine di tipo Axiabore™

Per ulteriori dettagli sull'applicazione fare riferimento alle istruzioni operative fornite con le teste di barenatura e con le barre GL.

Testa	Capacità Ø mm (pollici)	Numero massimo di giri al minuto con utensile (giri al minuto)	Numero massimo di giri al minuto con MPA (giri al minuto)	Velocità di taglio massima v_c alla cap. min. m/min (sf/min)	Velocità di taglio massima v_c alla cap. max m/min (sf/min)
Tipo Axiabore™ con connessione Graflex®					
A76001	0,3-8 (0.0118-0.315)	30000	-	28* (92°)	754* (2474°)
A76002	2-20 (0.0787-0.787)	12000	-	75* (246°)	754* (2474°)
A76003	6-108 (0.236-4.25)	8000**	5000	151* (495°)	1000*** (3281***)
A76013	6-33 (0.236-1.30)	20000**	5000	377* (1237°)	1500*** (4921***)
Tipo Axiabore™ con connessione Seco-Capto™					
C5-391.0760-03	6-108 (0.236-4.25)	8000*	5000	151* (495°)	1000** (3281**)

Nota: Le velocità massime sono correlate al design meccanico delle teste di barenatura e alla qualità di equilibratura. Le velocità all'interno di questi limiti devono essere scelte in funzione delle altre condizioni di lavorazione, ad esempio materiale da lavorare, geometria del tagliente (utensili e inserti), lunghezza utensile, mandrino macchina. A velocità superiori agli 8000 giri al minuto, gli attacchi e le prolunghie devono essere equilibrati con precisione. L'uso di teste equilibrabili e attacchi equilibrati con precisione migliora la durata utensile e le prestazioni di barenatura anche a velocità inferiori.

* Velocità di taglio massima consigliata al numero massimo di giri al minuto.

** Non raggiungibile con tutti gli utensili, vedere ***.

*** Velocità di taglio massima da non superare

Istruzioni per la risoluzione dei problemi (valide anche per testine per barenatura di tipo radiale)

Problema	Possibile causa	Soluzione
Scarsa durata utensile	Qualità inserto non corretta	Utilizzare una qualità più resistente all'usura
	Velocità di taglio troppo elevata	Ridurre la velocità di taglio
	Eccessiva profondità di taglio	Diminuire profondità di taglio
Vibrazioni	Velocità di taglio troppo elevata	Ridurre la velocità di taglio
	Rapporto L/D elevato	Accorciare l'utensile per aumentarne la rigidità
		Utilizzare un utensile di barenatura più robusto
		Utilizzare una barra Steadyline
	Utilizzare prolunghe in metallo duro o in metallo pesante	
Inserto non adatto	Ridurre il raggio di punta dell'inserto Utilizzare inserti con geometria rettificata	
Sovrametallo non corretto	Cambiare diametro pre-barenatura	
Tolleranza diametro e ripetibilità non soddisfacenti	Cambi utensile non corretti	Stelo utensile usurato e danneggiato: sostituirlo Pulire mandrino e stelo utensile
	Variazione del sovrametallo	Aggiungere fase di barenatura di semifinitura
	Bassa stabilità mandrino	Utilizzare inserti affilati con geometria rettificata
Scarsa rotondità	Disequilibrio eccessivo utensile di barenatura	Controllare l'eccentricità del mandrino
		Passare alla testina per barenatura LIBRAFLEX®
		Controllare regolazione anello di equilibratura
		Ridurre la velocità
	Forze di taglio troppo elevate	Controllare sovrametallo ed avanzamento
Bloccaggio insufficiente del pezzo da lavorare	Controllare bloccaggio uniforme del pezzo da lavorare	
Pezzo da lavorare non simmetrico	Ridurre forze di taglio, passare a inserto rettificato Aumentare la velocità e ridurre l'avanzamento	
Scarsa tolleranza di posizionamento	Preforo non allineato	Aggiungere fase di barenatura di semifinitura
	Eccessiva profondità di taglio	Diminuire profondità di taglio, fare due passaggi
Cattiva finitura superficiale	Raggio dell'inserto non idoneo	Utilizzare un raggio dell'inserto più ampio
	Avanzamento eccessivo	Ridurre avanzamento in modo che sia al max il 30% del raggio dell'inserto
	Scarsa evacuazione del truciolo	Impiegare adduzione refrigerante interna
		Impiegare inserto più positivo (HSS: chiedere informazioni)
Controllare profondità di taglio		
Barenatura conica	Usura prematura	Utilizzare una qualità più resistente all'usura
		Modificare la velocità di taglio
		Aumentare flusso liquido refrigerante

Panoramica

Introduzione

Graflex®

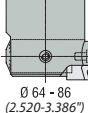
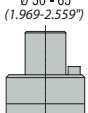
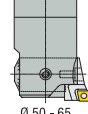
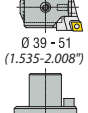
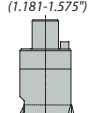
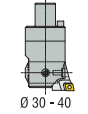
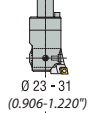
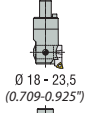
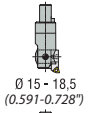

Foratura

Graflex® equilibrabili

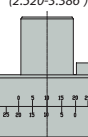
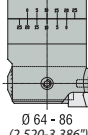
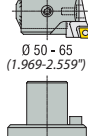
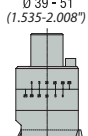
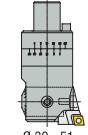
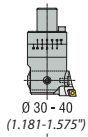

Seco-Capto™

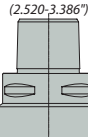
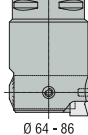
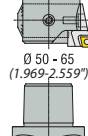
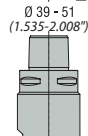
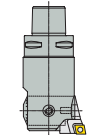

Connessione GL

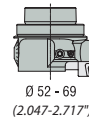

Connessione BA

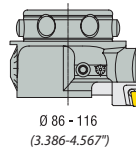
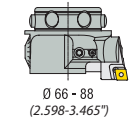

Alesatura

Barenatura

Allegato

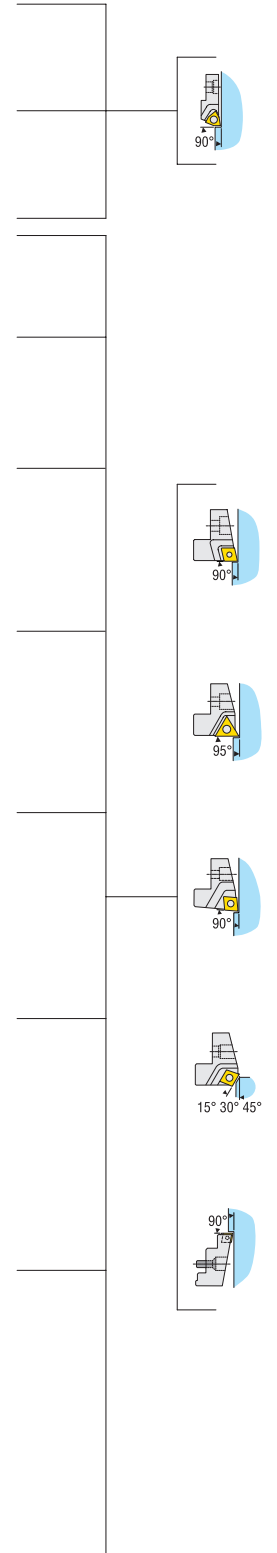

Testine per barenatura di finitura – Guida

Caratteristiche

Una testina per barenatura di finitura di tipo radiale è composta dall'assemblato di un corpo (testina) e di un portainsero. Caratteristiche delle testine per barenatura di finitura radiali FB 620, FB 780 e FB 790:

Gamma prodotti

Seco offre una varietà di testine radiali per barenatura di finitura, per soddisfare tutte le vostre necessità con la soluzione più appropriata:

Caratteristiche delle testine per barenatura di finitura radiali FB 620, FB 780 e FB 790



- Regolazione micrometrica. Inserire il portainsero con una vite micrometrica di regolazione, 1 incremento = 0,01 mm (0,0004") sul diametro ed un nonio, risoluzione di 2,5 µm (98,4 µin) sul diametro
- La precisione del meccanismo garantisce l'accuratezza della ripetibilità
- L'orientamento angolare del tagliente è conforme alla norma DIN 69871/ISO 7388 per SA e alla norma ISO 12164 per HSK
- Refrigerante attraverso la testina diretto verso il tagliente
- Le testine per barenatura FB 780 e FB 620 sono pre-equilibrate sul diametro medio. Le testine FB 790 sono bilanciabili (bilanciatura fine), per prestazioni ottimizzate.

Nota: Caratteristiche, istruzioni (montaggio del portainsero, regolazione del diametro, istruzioni per barenatura in tirata, risoluzione dei problemi, condizioni di lavorazione consigliate, velocità massime), portainseri ed inserti dedicati sono identici a quelli delle testine FB 620, FB 780 e FB 790 di finitura della stessa capacità di barenatura, indipendentemente dal tipo di connessione.

Testine FB 620 per barenatura di finitura, tipo radiale, per barre Steadyline® con smorzamento delle vibrazioni



GL



BA

- 4 testine per barenatura di finitura con connessione lato macchina GL per barenatura di finitura Ø 27–69 mm (Ø 1,102–2,717")
- 2 testine per barenatura di finitura con connessione lato macchina BA per barenatura di finitura Ø 66–116 mm (Ø 2,598–4,567")

Il loro disegno compatto consente il miglior smorzamento delle vibrazioni quando usate su barre Steadyline® GL di tornitura e di barenatura.

Testine FB 780 per barenatura di finitura, tipo radiale

9 testine per barenatura di precisione con connessione lato macchina Graflex® per barenatura di finitura \varnothing 15-205 mm (\varnothing 0,591–8,071") utilizzando portainseriti montati radialmente.

5 testine per barenatura di precisione con connessione lato macchina Seco-Capto™ per barenatura di finitura \varnothing 39–205 mm (\varnothing 1,535–8,071").

Adattatore Seco-Capto™ e testina Graflex®: \varnothing 15-40 mm (\varnothing 0,591– 1,575").

Nota: Le testine per barenatura di finitura Seco-Capto™ possono barenare fori di \varnothing minimo 39 mm (\varnothing 1,535"), con la più piccola dimensione Seco-Capto™ C3. Per \varnothing 15-40 mm (\varnothing 0,591–1,575") usare le testine per barenatura Graflex® con dimensione di connessione da G0 a G2, insieme all'appropriato adattatore Seco-Capto™/Graflex®. Questo offre anche modularità nella lunghezza di barenatura quando si usano prolunghe Graflex®.

Nota: Caratteristiche, istruzioni (montaggio del portainserito, regolazione del diametro, istruzioni per barenatura in tirata, risoluzione dei problemi, condizioni di lavorazione consigliate, velocità massime), portainseriti ed inserti dedicati sono analoghi a quelli delle testine FB 780 di finitura della stessa capacità di barenatura, indipendentemente dal tipo di connessione.

Testine FB 790 equilibrabili per barenatura di finitura, tipo radiale

5 testine equilibrabili "Libraflex®" con connessione Graflex® lato macchina per barenatura di finitura \varnothing 30-115 mm (\varnothing 1,181–4,528"), ad elevate velocità, fino a 1500 m/min (4921 sf/min),, utilizzando portainseriti montati radialmente.

L'equilibratura riduce gli sforzi sul mandrino, i parametri di taglio possono essere ottimizzati, per ottenere una migliore qualità di lavorazione anche alle velocità convenzionali.

L'equilibratura è ottenuta impostando entrambi gli anelli graduati conformemente al diametro da barenare (non servono tabelle).



Caratteristiche

Portainseri

Una testina per barenatura di finitura di tipo radiale è composta dall'assemblato di un corpo (testina) e di un portainsero.

L'ampia gamma di portainseri per barenatura di finitura, smussatura e barenatura in tirata è adatta alle testine per barenatura di finitura FB 620, FB 780 ed FB 790 di tipo radiale.

Portainseri per barenatura di finitura

FBIH 782: angolo di attacco di 90° per inserti WB

FBIH 724: angolo di attacco di 90° per inserti TC

FBIH 725: angolo di attacco di 90° per inserti CC

FBIH 726: angolo di attacco di 95° per inserti CC

Nota: i portainseri con angolo d'attacco 95° devono essere usati per evitare il contatto superficiale quando si esegue la barenatura di un foro cieco.

Portainseri di smussatura, Ø da 23 a 160 mm (Ø 0,906–6,299")

FBIH 729: disponibile con un angolo di attacco di 15°, 30° o 45° per inserti CC.

L'equilibratura Libraflex® può anche essere ottenuta utilizzando i portainseri di smussatura.

Portainseri per barenatura in tirata, Ø da 26,5 a 164 mm (Ø 1,043–6,457")

FBIH A789: angolo di attacco di 90° per inserti WB e CC.

L'equilibratura Libraflex® non è possibile quando si utilizzano i portainseri per barenatura in tirata. In questo caso, la maggiore riduzione del disequilibrio è ottenuta quando entrambi gli anelli di equilibratura sono impostati sulla gradazione più alta.

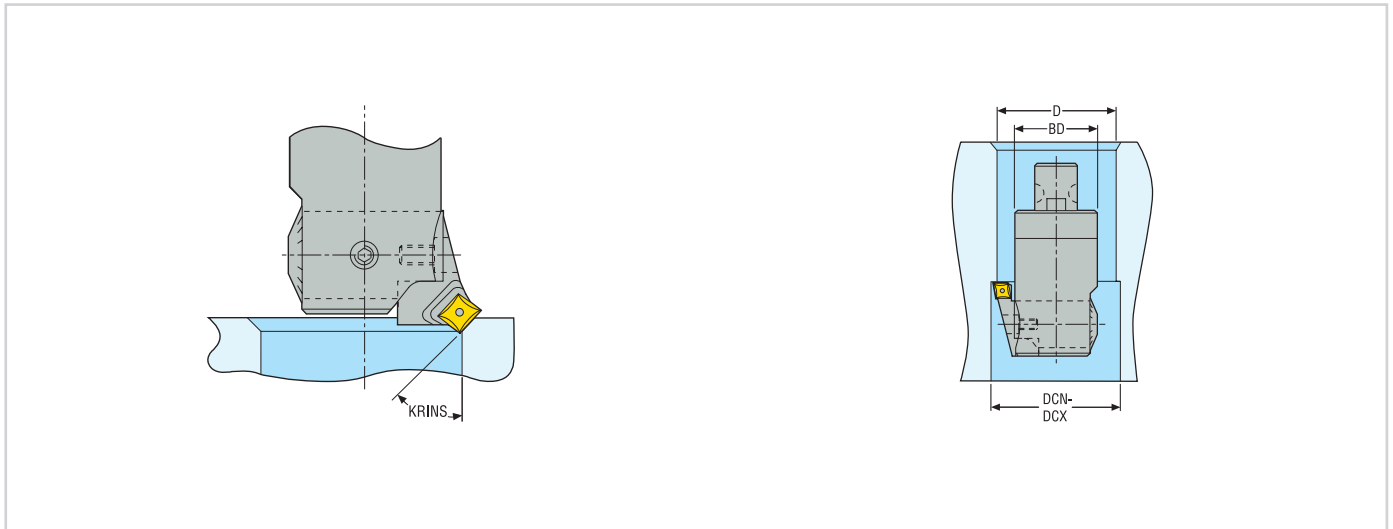

FB780

Graflex®

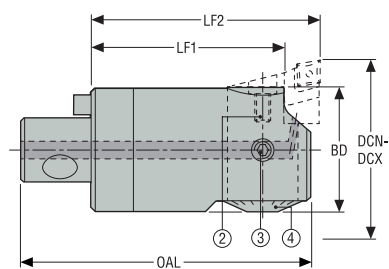

- Con regolazione micrometrica (incremento 0,01 mm e nonio 2,5 µm, sul diametro)

2. Vite di assemblaggio
3. Vite di bloccaggio
4. Vite di regolazione micrometrica

Codice di ordinazione	Codice prodotto	Lato macchina Dimensione Graflex	Lato utensile Capacità DCN-DCX Ø		OAL	LF1	LF2	BD	Peso	Dimensione portainsero
			mm Inch	mm Inch						
A78008	00056632	G0	15,0 0.591	18,5 0.728	44,0 1.732	27,5 1.083	35,0 1.378	14,0 0.551	0,1 0.220	09
A78009	00056633	G0	18,0 0.709	23,5 0.925	44,0 1.732	27,5 1.083	35,0 1.378	17,0 0.669	0,1 0.220	09
A78010	00072991	G1	23,0 0.906	31,0 1.220	51,5 2.028	32,5 1.280	40,0 1.575	21,5 0.846	0,2 0.440	10
A78020	00072992	G2	30,0 1.181	40,0 1.575	59,5 2.343	37,5 1.476	45,0 1.772	27,0 1.063	0,22 0.490	20
A78030	00072993	G3	39,0 1.535	51,0 2.008	82,0 3.228	54,5 2.146	65,0 2.559	35,0 1.378	0,6 1.320	30
A78040	00072995	G4	50,0 1.969	65,0 2.559	93,0 3.661	61,5 2.421	72,0 2.835	43,0 1.693	0,9 1.980	40
A78050	00072996	G5	64,0 2.520	86,0 3.386	109,0 4.291	71,5 2.815	82,0 3.228	54,0 2.126	1,6 3.530	50
A78060	00056551	G6	85,0 3.346	144,0 5.669	140,0 5.512	88,5 3.484	105,0 4.134	70,0 2.756	3,2 7.050	60/65
A78070	00056552	G7	114,0 4.488	205,0 8.071	160,0 6.299	98,5 3.878	115,0 4.528	95,0 3.740	6,4 14.110	70/75

I portainseri devono essere ordinati a parte, vedere le pagine 654, 655-657
Nota: Il peso è senza portainsero

Parti di ricambio, comprese nella fornitura

Per	Vite di assemblaggio	Chiave (impugnatura a T)	Chiave	Vite di bloccaggio	Tenone
A78008	960D30050S	DOUBLE-T	H4B-H2.0	19A7100403	-
A78009	-	DOUBLE-T	H4B-H2.0	19A71000	90M0
A78010	19TB0305	DOUBLE-T	H4B-H2.0	19A71000	90M1
A78020	19TB0305	H4B-H2.0	-	950L0406	90M2
A78030	19TB04075	-	03M03C	950L0608	90M3
A78040	19TB04075	-	03M03C	950L0612	90M4
A78050	950D0410	-	03M03C	950L0616	90M5
A78060	950D0612	DOUBLE-T	H6B-H5.0L	950L1016	90M6
A78070	950D0616	DOUBLE-T	H6B-H5.0L	950L1030	90M7

Accessori

Per		Chiave dinamometrica per viti di bloccaggio e di assemblaggio
		
A78008		H00-2009
A78009		H00-2009
A78010		H00-2009
A78020		H00-2009
A78030		H00-3030
A78040		H00-3030
A78050		H00-3030
A78060		H00T-50100
A78070		H00T-50100

Introduzione

Foratura

Alesatura

Barenatura

Allegato

FB780

Seco-Capto™

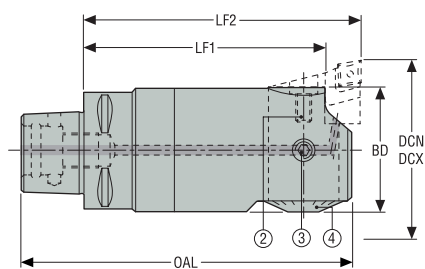

- Con regolazione micrometrica (incremento 0,01 mm e nonio 2,5 µm, sul diametro)

2. Vite di assemblaggio
3. Vite di bloccaggio
4. Vite di regolazione micrometrica

Codice di ordinazione	Codice prodotto	Lato macchina	Lato utensile		OAL	LF1	LF2	BD	Peso	Dimensione portainsero
			Capacità	DCN-DCX Ø						
			mm	mm	mm	mm	mm	mm	kg	
			Inch	Inch	Inch	Inch	Inch	Inch	lb	
C3-391.0780-30	02809740	C3	39,0	51,0	86,0	59,5	70,0	35,0	0,6	30
			1.535	2.008	3.386	2.343	2.756	1.378	1.320	
C4-391.0780-40	02809742	C4	50,0	65,0	103,0	71,5	82,0	43,0	1,0	40
			1.969	2.559	4.055	2.815	3.228	1.693	2.200	
C5-391.0780-50	02809744	C5	64,0	86,0	119,0	81,5	92,0	54,0	1,7	50
			2.520	3.386	4.685	3.209	3.622	2.126	3.750	
C6-391.0780-60	02809745	C6	85,0	144,0	150,0	100,5	117,0	70,0	3,3	60
			3.346	5.669	5.906	3.957	4.606	2.756	7.280	
C8-391.0780-70	02809747	C8	114,0	205,0	181,0	121,5	138,0	95,0	7,1	70
			4.488	8.071	7.126	4.783	5.433	3.740	15.650	

I portainseri devono essere ordinati a parte, vedere le pagine 654, 655-657
Nota: Il peso è senza portainsero

Parti di ricambio, comprese nella fornitura

Per	Vite di assemblaggio	Chiave (a bandiera)	Chiave (impugnatura a T)	Chiave	Vite di bloccaggio
C3-391.0780-30	19TB04075	03M03C	-	-	950L0608
C4-391.0780-40	19TB04075	03M03C	-	-	950L0612
C5-391.0780-50	950D0410	03M03C	-	-	950L0616
C6-391.0780-60	950D0612	-	DOUBLE-T	H6B-H5.0L	950L0616
C8-391.0780-70	950D0616	-	DOUBLE-T	H6B-H5.0L	950L1030

Accessori

Per	Chiave dinamometrica per viti di bloccaggio e di assemblaggio
C3-391.0780-30	H00-3030
C4-391.0780-40	H00-3030
C5-391.0780-50	H00-3030
C6-391.0780-60	H00T-50100
C8-391.0780-70	H00T-50100

Introduzione

Foratura

Alesatura

Barenatura

Allegato

FB780 Libraflex® equilibrabile

Graflex®

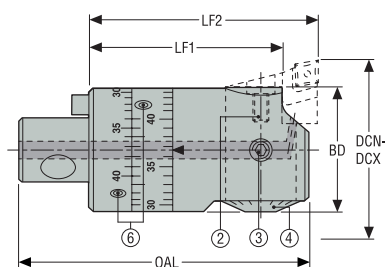

- 6. Vite di bloccaggio 2
- 2. Vite di assemblaggio
- 3. Vite di bloccaggio 1
- 4. Vite di regolazione micrometrica

- Con regolazione micrometrica (incremento 0,01 mm e nonio 2,5 µm, sul diametro)
- L'equilibratura è ottenuta impostando entrambi gli anelli conformemente al diametro da barenare
- Per velocità v_c fino a 1 495 m/min e superiori, vedere le pagine 658

Codice di ordinazione	Codice prodotto	Lato macchina Dimensione Graflex	Lato utensile Capacità DCN-DCX Ø		OAL	LF1	LF2	BD	Peso	Dimensione portainserto
			mm Inch	mm Inch						
A79020	00055932	G2	30,0 1.181	40,0 1.575	59,5 2.343	37,5 1.476	45,0 1.772	27,0 1.063	0,3 0.660	20
A79030	00056005	G3	39,0 1.535	51,0 2.008	82,0 3.228	54,5 2.146	65,0 2.559	35,0 1.378	0,5 1.100	30
A79040	00056006	G4	50,0 1.969	65,0 2.559	93,0 3.661	61,5 2.421	72,0 2.835	43,0 1.693	0,9 1.980	40
A79050	00056007	G5	64,0 2.520	86,0 3.386	109,0 4.291	71,5 2.815	82,0 3.228	54,0 2.126	1,5 3.310	50
A79060	00001451	G6	85,0 3.346	115,0 4.528	140,0 5.512	88,5 3.484	105,0 4.134	70,0 2.756	3,0 6.610	60

I portainserti devono essere ordinati a parte, vedere le pagine 654, 655-657
Nota: Il peso è senza portainserto

Parti di ricambio, comprese nella fornitura

Per testa	Vite di assemblaggio	Chiave (impugnatura a T)	Chiave	Vite di bloccaggio 1	Vite di bloccaggio 2	Tenone
A79020	19TB0305	DOUBLE-T	H4B-H2.0	950L0406	960D30045S	90M2
A79030	19TB04075	-	03M03C	950L0608	AU7901030	90M3
A79040	19TB04075	-	03M03C	950L0612	AU7901040	90M4
A79050	950D0410	-	03M03C	950L0616	AU7901050	90M51
A79060	950D0612	DOUBLE-T	H6B-H5.0L	950L1016	AU7901060	90M6

Accessori

Per testa	Chiave dinamometrica per viti di bloccaggio dell'anello di equilibratura	Chiave dinamometrica per viti di bloccaggio e di assemblaggio
A79020	-	H00-2009
A79030	H00-3020	H00-3030
A79040	H00-3020	H00-3030
A79050	H00-3020	H00-3030
A79060	H00T-5050	H00T-50100

FB 620 GL - Teste per barenatura di finitura

compatto, con connessione GL

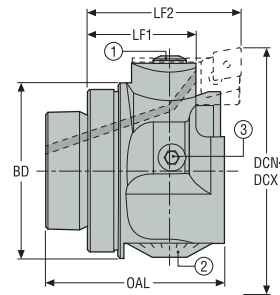

- Per barre di tornitura e barenatura Steadylite® GL25, GL32, GL40 e GL50
- Adduzione interna di refrigerante verso il tagliente
- Con regolazione micrometrica (incremento 0,01 mm e nonio 2,5 µm, sul diametro)

1. Vite di assemblaggio
2. Vite di regolazione micrometrica
3. Vite di bloccaggio





Codice di ordinazione	Codice prodotto	Lato macchina Dimensione GL	Lato utensile Capacità DCN-DCX Ø		OAL	LF1	LF2	BD	Peso	Max. num. di giri**
			mm Inch	mm Inch						
GL25-FB620-10	03307855	GL25	27,0 1.063	35,0 1.378	29,5 1.161	17,7 0.697	28,0 1.102	25,0 0.984	0,2 0.440	9000
GL32-0620-20	02904469	GL32	34,0 1.339	46,0 1.811	35,2 1.386	23,75 0.935	32,1 1.264	32,0 1.260	0,2 0.440	7000
GL40-0620-30	02904470	GL40	42,0 1.654	56,0 2.205	40,7 1.602	24,75 0.974	35,1 1.382	40,0 1.575	0,3 0.660	5600
GL50-0620-40	02904471	GL50	52,0 2.047	69,0 2.717	43,7 1.720	25,75 1.014	36,1 1.421	50,0 1.969	0,4 0.880	4800

I portainseriti devono essere ordinati a parte, vedere le pagine 654, 655-657

** Per ulteriori informazioni sul numero massimo di giri al minuto, vedere le pagine di istruzioni.

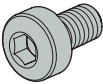
Nota: Il peso è senza portainserito

Parti di ricambio, comprese nella fornitura

Per testa	Vite di assemblaggio	Chiave per vite staffa	Chiave (impugnatura a T)	Vite di bloccaggio
GL25-FB620-10	 19TB0305	 H2.0-2D	 -	 19A71000
GL32-0620-20	19TB0305	H4B-H2.0	DOUBLE-T	950L0406
GL40-0620-30	19TB04075	03M03C	-	950L0608
GL50-0620-40	19TB04075	03M03C	-	950L0608

Accessori

Per testa	Chiave dinamometrica per viti di bloccaggio e di assemblaggio
GL25-FB620-10	-
GL32-0620-20	H00-2009
GL40-0620-30	H00-3030
GL50-0620-40	H00-3030



Introduzione

Foratura

Alesatura

Barenatura

Allegato

FB 620 BA - Teste per barenatura di finitura

con connessione BA

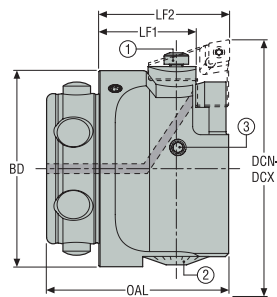

1. Vite di assemblaggio
2. Vite di regolazione micrometrica
3. Vite di bloccaggio

- Progettate per barre Steadyline® BA60 e BA80 per tornitura e barenatura
- Adduzione interna di refrigerante verso il tagliente
- Con regolazione micrometrica (incremento 0,01 mm e nonio 2,5 µm, sul diametro)







Codice di ordinazione	Codice prodotto	Lato macchina Dimensione BA	Lato utensile Capacità DCN-DCX		OAL	LF1	LF2	BD	Peso	Max. num. di giri**
			mm	mm						
BA060-FB620-50	03204094	BA060	65,0 2.559	87,0 3.425	55,7 2.193	29,7 1.169	40,0 1.575	60,0 2.362	0,7 1.540	4000
BA080-FB620-60	03204095	BA080	85,0 3.346	115,0 4.528	58,2 2.291	26,7 1.051	41,2 1.622	80,0 3.150	1,2 2.650	3000

I portainseri devono essere ordinati a parte, vedere le pagine 606

** Per ulteriori informazioni sul numero massimo di giri al minuto, vedere le pagine di istruzioni.

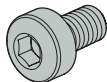
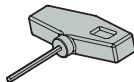
Nota: Il peso è senza portainsero

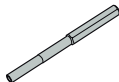
Parti di ricambio, comprese nella fornitura

Per testa	Vite di assemblaggio	Chiave (a bandiera)	Chiave (impugnatura a T)	Chiave	Vite di bloccaggio
BA060-FB620-50	 19TB04075	 03M03C	 -	 -	 950L0608
BA080-FB620-60	950D0514	-	DOUBLE-T	H6B-H5.0L	950L0608

Portainsero

per teste per barenatura di finitura FB 620 / 780 / 790

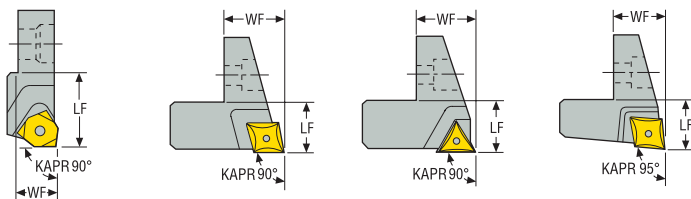

- Per teste di barenatura radiale FB 620 / 780 / 790
- **L'equilibratura di precisione delle teste FB A790 non è possibile quando si utilizzano portainseri grandi.

A B C D

Codice di ordinazione	Codice prodotto	Tipologia portainsero	Capacità DCN-DCX \varnothing		LF	WF	Peso	Per testa	KRINS°	**	Dimensione portainsero	Dimensione inserto	Disegno
			mm Inch	mm Inch									
A78209	00056634	90° per inserti WB	15,0 0.591	23,5 0.925	7,2 0.283	4,0 0.157	0,1 0.220	FB 78008 / FB 78009	90	-	09	WB...0301...	A
A72510	00056580	90° per inserti CC	23,0 0.906	31,0 1.220	10,3 0.406	4,5 0.177	0,1 0.220	FB 78010 / FB62010	90	-	10	CC...0602...	B
A72520	00056581	90° per inserti CC	30,0 1.181	46,0 1.811	8,3 0.327	5,0 0.197	0,1 0.220	FB 78020 / FB 79020 / FB 62020	90	-	20	CC...0602...	B
A72530	00056582	90° per inserti CC	39,0 1.535	56,0 2.205	10,3 0.406	8,0 0.315	0,1 0.220	FB 78030 / FB 79030 / FB 62030	90	-	30	CC...0602...	B
A72540	00056583	90° per inserti CC	50,0 1.969	69,0 2.717	10,3 0.406	9,5 0.374	0,1 0.220	FB 78040 / FB 79040 / FB 62040	90	-	40	CC...0602...	B
A72550	00056584	90° per inserti CC	64,0 2.520	86,0 3.386	10,3 0.406	12,5 0.492	0,1 0.220	FB 78050 / FB 79050 / FB 62050	90	-	50	CC...0602...	B
A7256A	02689978	90° per inserti CC	85,0 3.346	115,0 4.528	14,5 0.571	18,5 0.728	0,2 0.440	BA080-FB620-60	90	-	6A	CC...09T3...	B
A72560	00056585	90° per inserti CC	85,0 3.346	115,0 4.528	16,5 0.650	18,9 0.744	0,2 0.440	FB 78060 / FB 79060 / FB 731S500	90	-	60	CC...09T3...	B
A72565	00056587	90° per inserti CC	114,0 4.488	144,0 5.669	16,5 0.650	33,7 1.327	0,2 0.440	FB 78060 / FB 79060 / FB 731S500	90	**	65	CC...09T3...	B
A72570	00056588	90° per inserti CC	114,0 4.488	160,0 6.299	16,5 0.650	18,9 0.744	0,2 0.440	FB 78070	90	-	70	CC...09T3...	B
A72575	00056589	90° per inserti CC	159,0 6.260	205,0 8.071	16,5 0.650	41,7 1.642	0,2 0.440	FB 78070	90	-	75	CC...09T3...	B
A72430	00056572	90° per inserti TC	39,0 1.535	56,0 2.205	10,3 0.406	7,9 0.311	0,1 0.220	FB 78030 / FB 79030 / FB 62030	90	-	30	TC...1102...	C
A72440	00056573	90° per inserti TC	50,0 1.969	69,0 2.717	10,3 0.406	9,4 0.370	0,1 0.220	FB 78040 / FB 79040 / FB 62040	90	-	40	TC...1102...	C
A72450	00056574	90° per inserti TC	64,0 2.520	86,0 3.386	10,3 0.406	12,4 0.488	0,1 0.220	FB 78050 / FB 79050 / FB 62050	90	-	50	TC...1102...	C
A72460	00056575	90° per inserti TC	85,0 3.346	115,0 4.528	16,3 0.642	18,9 0.744	0,2 0.440	FB 78060 / FB 79060 / FB 731S500	90	-	60	TC...1102...	C
A72465	00056577	90° per inserti TC	114,0 4.488	144,0 5.669	16,5 0.650	33,7 1.327	0,2 0.440	FB 78060 / FB 79060 / FB 731S500	90	**	65	TC...1102...	C
A72470	00056578	90° per inserti TC	114,0 4.488	160,0 6.299	16,3 0.642	18,9 0.744	0,2 0.440	FB 78070	90	-	70	TC...1102...	C
A72475	00056579	90° per inserti TC	159,0 6.260	205,0 8.071	16,5 0.650	41,7 1.642	0,2 0.440	FB 78070	90	-	75	TC...1102...	C
A72610	00056590	95° per inserti CC	23,0 0.906	31,0 1.220	10,3 0.406	4,5 0.177	0,1 0.220	FB 78010	95	-	10	CC...0602...	D
A72620	00056591	95° per inserti CC	30,0 1.181	46,0 1.811	8,3 0.327	5,0 0.197	0,1 0.220	FB 78020 / FB 79020 / FB 62020	95	-	20	CC...0602...	D
A72630	00056592	95° per inserti CC	39,0 1.535	56,0 2.205	10,3 0.406	8,0 0.315	0,1 0.220	FB 78030 / FB 79030 / FB 62030	95	-	30	CC...0602...	D
A72640	00056593	95° per inserti CC	50,0 1.969	69,0 2.717	10,3 0.406	9,5 0.374	0,1 0.220	FB 78040 / FB 79040 / FB 62040	95	-	40	CC...0602...	D

Codice di ordinazione	Codice prodotto	Tipologia portainsero	Capacità DCN-DCX Ø		LF	WF	Peso	Per testa	KRINS°	**	Dimensione portainsero	Dimensione inserto	Disegno
			mm <i>Inch</i>	mm <i>Inch</i>									
A72650	00056594	95° per inserti CC	64,0 2.520	86,0 3.386	10,3 0.406	12,5 0.492	0,1 0.220	FB 78050 / FB 79050 / FB 62050	95	-	50	CC...0602...	D
A72660	00056595	95° per inserti CC	85,0 3.346	115,0 4.528	16,5 0.650	18,9 0.744	0,2 0.440	FB 78060 / FB 79060 / FB 731S500	95	-	60	CC...09T3...	D
A72665	00056597	95° per inserti CC	114,0 4.488	144,0 5.669	16,5 0.650	33,7 1.327	0,2 0.440	FB 78060 / FB 79060 / FB 731S500	95	**	65	CC...09T3...	D
A72670	00056598	95° per inserti CC	114,0 4.488	160,0 6.299	16,5 0.650	18,9 0.744	0,2 0.440	FB 78070	95	-	70	CC...09T3...	D
A72675	00056599	95° per inserti CC	159,0 6.260	205,0 8.071	16,5 0.650	41,7 1.642	0,2 0.440	FB 78070	95	-	75	CC...09T3...	D

Parti di ricambio, comprese nella fornitura

Per dimensione inserto	Chiave per vite inserto	Vite di bloccaggio inserto	Chiave (impugnatura a T)
			
WB...0301...	H4B-T06P	C02035-T06P	DOUBLE-T
CC...0602...	H4B-T07P	C02504-T07P	DOUBLE-T
CC...09T3...	H4B-T15P	C04008-T15P	DOUBLE-T
TC...1102...	H4B-T07P	C02504-T07P	DOUBLE-T

Introduzione

Foratura

Alesatura

Barenatura

Allegato

Portainseri per smussatura

per teste per barenatura di finitura FB 620 / 780 / 790

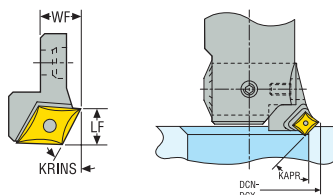

- Per teste di barenatura radiale FB 620 / 780 / 790

Codice di ordinazione	Codice prodotto	Per testa	Dimensione portainsero	Capacità DCN-DCX Ø		LF	WF	Peso	KRINS°	Dimensione inserto
				mm Inch	mm Inch					
A72910CC0630	00086885	FB 78010	10	23,0 0.906	31,0 1.220	10,8 0.425	4,5 0.177	0,1 0.220	30	CC...0602...
A72920CC0630	00086888	FB 78020 / FB 79020/ GL32-0620-20	20	30,0 1.181	36,0 1.417	10,0 0.394	4,9 0.193	0,1 0.220	30	CC...0602...
A72930CC0630	00086891	FB 78030 / FB 79030 / FB 62030	30	39,0 1.535	56,0 2.205	10,5 0.413	8,1 0.319	0,1 0.220	30	CC...0602...
A72940CC0630	00086894	FB 78040 / FB 79040 / FB 62040	40	50,0 1.969	69,0 2.717	10,5 0.413	9,5 0.374	0,1 0.220	30	CC...0602...
A72950CC0630	00086897	FB 78050 / FB 79050	50	64,0 2.520	86,0 3.386	10,5 0.413	12,5 0.492	0,1 0.220	30	CC...0602...
A72960CC0930	00086900	FB 78060 / FB 79060 / A731S500	60	85,0 3.346	115,0 4.528	16,5 0.650	19,1 0.752	0,08 0.180	30	CC...09T3...
A72970CC0930	00086903	FB 78070	70	114,0 4.488	160,0 6.299	16,4 0.646	18,8 0.740	0,09 0.200	30	CC...09T3...
A72910CC0645	00086886	FB 78010	10	23,0 0.906	31,0 1.220	11,5 0.453	4,5 0.177	0,01 0.020	45	CC...0602...
A72920CC0645	00086889	FB 78020 / FB 79020 / FB 62020	20	30,0 1.181	46,0 1.811	10,0 0.394	5,0 0.197	0,1 0.220	45	CC...0602...
A72930CC0645	00086892	FB 78030 / FB 79030 / FB 62030	30	39,0 1.535	56,0 2.205	10,5 0.413	8,1 0.319	0,1 0.220	45	CC...0602...
A72940CC0645	00086895	FB 78040 / FB 79040 / FB 62040	40	50,0 1.969	69,0 2.717	10,5 0.413	9,5 0.374	0,1 0.220	45	CC...0602...
A72950CC0645	00086898	FB 78050 / FB 79050	50	64,0 2.520	86,0 3.386	10,3 0.406	12,4 0.488	0,02 0.040	45	CC...0602...
A72960CC0945	00086901	FB 78060 / FB 79060 / A731S500	60	85,0 3.346	115,0 4.528	16,5 0.650	19,1 0.752	0,2 0.440	45	CC...09T3...
A72970CC0945	00086904	FB 78070	70	114,0 4.488	160,0 6.299	16,4 0.646	18,8 0.740	0,09 0.200	45	CC...09T3...

Per i ricambi di viti e chiavi inserto, vedere le pagine 690

**Per la capacità DC con ponti di barenatura e ponti di barenatura Jumbo, vedere pagina 666

Parti di ricambio, comprese nella fornitura

Per dimensione inserto	Chiave per vite inserto	Vite di bloccaggio inserto	Chiave (impugnatura a T)
CC...0602...	H4B-T07P	C02504-T07P	DOUBLE-T
CC...09T3...	H4B-T15P	C04008-T15P	DOUBLE-T

Portainseri per barenatura di finitura in tirata

per teste per barenatura di finitura FB 620 / 780 / 790

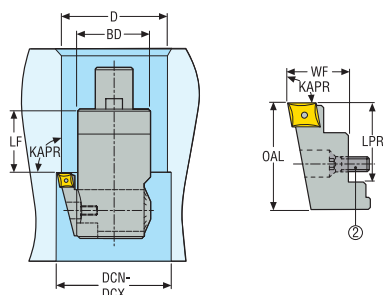

- Per teste di barenatura radiale FB 620 / 780 / 790
- L'equilibratura di precisione delle teste FB 790 non è possibile quando si utilizzano portainseri per barenatura in tirata
- KRINS 90°
- Dimensione inserto: CC...0602...

Codice di ordinazione	Codice prodotto	Per testa	Capacità DCN-DCX di barenatura in tirata Ø		LF	BD	OAL	LPR	WF	Peso
			mm	(Inch)						
A789X10CC0690	00086907	A78010	39,5-47,5	(1.555-1.870)	16,5 (0.650)	21,5 (0.846)	30,5 (1.201)	16,0 (0.630)	12,8 (0.504)	0,01 (0.020)
		A78020 & A79020	46-56	(1.811-2.205)	21,5 (0.846)	27 (1.063)				
		GL32-0620-20	49,7-61,7	(1.957-2.429)	7,75 (0.305)	32 (1.260)				
A789X30CC0690	00086910	A78030 & A79030	53-65	(2.087-2.559)	32 (1.260)	35 (1.378)	30,0 (1.181)	23,0 (0.906)	15,0 (0.591)	0,03 (0.070)
		A78040 & A79040	61-76	(2.402-2.992)	39 (1.535)	43 (1.693)				
		A78050 & A79050	69-91	(2.717-3.583)	49 (1.929)	54 (2.126)				
		GL40-0620-30	57,6-70,2	(2.268-2.764)	1,75 (0.069)	40 (1.575)				
		GL50-0620-40	67,6-80,2	(2.661-3.157)	2,75 (0.108)	50 (1.969)				
A789X60CC0690	00086909	A78060 & A79060	89-119 *	(3.504-4.685 *)	50 (1.969)	70 (1.969)	50,0 (1.969)	38,5 (1.516)	21,0 (0.827)	0,09 (0.200)
A789X70CC0690	00086911	A78070	118-164	(4.646-6.457)	60 (2.362)	95 (2.362)	50,0 (1.969)	38,5 (1.516)	21,0 (0.827)	0,1 (0.220)

*Per la capacità di barenatura in tirata DC con ponti di barenatura e ponti di barenatura Jumbo, vedere pagina 670

Per i ricambi di viti e chiavi inserto, vedere le pagine 690

La fornitura di portainseri per barenatura di finitura in tirata include una specifica vite di serraggio del portainseri, da utilizzare al posto della vite di serraggio standard fornita con le teste di barenatura.

DCN/DCX mini = $D+BD / 2 + 0,5 \text{ mm (0,02" diametro da 39,5 a 47,5 (da 1,555" a 1,870")}$

DCB/DCX mini = $D+BD / 2 + 1 \text{ mm (0,039" diametro da 46 a 64 (da 1,811" a 2,520")}$

Parti di ricambio, comprese nella fornitura

Per	Vite di assemblaggio	Vite di bloccaggio inserto	Chiave (impugnatura a T)	Chiave
A789X10CC0690	950F0308	C02504-T07P	DOUBLE-T	H4B-T07P
A789X30CC0690	950F0410	C02504-T07P	DOUBLE-T	H4B-T07P
A789X60CC0690	-	C02504-T07P	DOUBLE-T	H4B-T07P
A789X70CC0690	-	C02504-T07P	DOUBLE-T	H4B-T07P

Testine per barenatura di finitura FB 780/790 – Istruzioni

Condizioni di lavorazione consigliate

Per ulteriori dettagli sull'applicazione, fare riferimento alle istruzioni operative fornite con le testine per barenatura e con le barre GL.

Velocità massime per testine per barenatura di finitura, tipo radiale

Le velocità massime mostrate sulle pagine prodotto dipendono dalla struttura meccanica delle testine per barenatura e dalla qualità di equilibratura. Le velocità all'interno di questi limiti devono essere scelte in funzione delle altre condizioni di lavorazione, ad esempio materiale da lavorare, geometria del tagliente, lunghezza utensile, mandrino macchina.

Nelle applicazioni di barenatura con barre Steadyline®, non superare mai le massime velocità di rotazione delle barre stesse: Vedere le istruzioni operative fornite con le barre Steadyline®.

Di seguito sono riportati il massimo numero di giri/min per testine per barenatura qualora si impieghino portainseriti di barenatura o smussatura. Qualora si impieghino portainseriti per barenatura in tirata su testine FB 620, FB 790 o FB 780, fare riferimento al massimo numero di giri per testine A780..., di dimensione simile.

Testa	Capacità Ø mm (pollici)	Max. num. di giri	Velocità di taglio massima consigliata v_c alla cap. min. m/min (sf/min)	Velocità di taglio massima consigliata v_c alla cap. max. m/min (sf/min)
Teste per barenatura di finitura FB 620, con connessione GL e BA, per barre Steadyline di tornitura e barenatura con smorzamento delle vibrazioni®				
GL25-FB620-10	27-35 (1.063-1.378)	9000	760 (2493)	1000 (3281)
GL32-FB620-20	34-46 (1.339-1.811)	7000	748 (2454)	1012 (3320)
GL32-FB620-30	42-56 (1.654-2.205)	5600	739 (2425)	985 (3232)
GL32-FB620-40	52-69 (2.047-2.717)	4800	784 (2572)	1040 (3412)
BA060-FB620-50	66-88 (2.598-3.465)	4000	830 (2723)	1105 (3625)
BA080-FB620-60	86-116 (3.386-4.567)	3000	810 (2657)	1093 (3586)
FB 790 Teste per barenatura di finitura, equilibrabili, con connessione Graflex®				
A79020	30-40 (1.181-1.575)	16000	1508 (4948)	2011 (6598)
A79030	39-51 (1.535-2.008)	12250	1501 (4925)	1963 (6440)
A79040	50-65 (1.969-2.559)	10000	1571 (5154)	2042 (6699)
A79050	64-86 (2.520-3.386)	7500	1508 (4948)	2026 (6647)
A79060	85-115 (3.346-4.528)	5600	1495 (4905)	2023 (6637)
FB 780 Teste per barenatura di finitura, con connessione Graflex®				
A78008	15-18,5 (0.591-0.728)	16000	754 (2474)	930 (3051)
A78009	18-23,5 (0.709-0.925)	13000	735 (2411)	960 (3150)
A78010	23-31 (0.906-1.220)	10000	723 (2372)	974 (3196)
A78020	30-40 (1.181-1.575)	8000	754 (2474)	1005 (3297)
A78030	39-51 (1.535-2.008)	6000	735 (2411)	961 (3153)
A78040	50-65 (1.969-2.559)	5000	785 (2575)	1021 (3350)
A78050	64-86 (2.520-3.386)	3700	744 (2441)	1000 (3281)
A78060	85-115 (3.346-4.528)	2700	721 (2365)	975 (3199)
	114-144 (4.488-5.669)	2200	788 (2585)	995 (3264)
A78070	114-160 (4.488-6.299)	2000	716 (2349)	1005 (3297)
	159-205 (6.260-8.071)	1600	799 (2621)	1030 (3379)
FB 780 Teste per barenatura di finitura, con connessione Seco-Capto™				
C3-391.0780-30	39-51 (1.535-2.008)	6000	735 (2411)	961 (3153)
C4-391.0780-40	50-65 (1.969-2.559)	5000	785 (2575)	1021 (3350)
C5-391.0780-50	64-86 (2.520-3.386)	3700	744 (2441)	1000 (3281)
C6-391.0780-60	85-115 (3.346-4.528)	2700	721 (2365)	975 (3199)
	114-144 (4.488-5.669)	2200	788 (2585)	995 (3264)
C8-391.0780-70	114-160 (4.488-6.299)	2000	716 (2349)	1005 (3297)
	159-205 (6.260-8.071)	1600	799 (2621)	1030 (3379)

Nota: Le velocità massime dipendono dalla struttura meccanica delle teste di barenatura e dalla qualità di equilibratura. Le velocità massime sono correlate alla struttura meccanica della testa di barenatura e alla qualità di equilibratura. Le velocità all'interno di questi limiti devono essere scelte in funzione delle altre condizioni di lavorazione, esempio materiale del pezzo da lavorare, tagliente (inserto), lunghezza utensile, mandrino macchina. Alle velocità di circa 8000 giri/min e superiori i portainseriti di base e le prolunghere/riduttori devono essere accuratamente equilibrati.



Ponti di barenatura

Seco offre una gamma completa di ponti di barenatura e ponti di barenatura Jumbo per barenature di ampi diametri per operazioni di tornitura esterna.

- Concepiti per la massima flessibilità, i ponti di barenatura vengono offerti con un'ampia scelta di diametri come prodotti standard e coprono una gamma di diametri di 204-655 mm (8,03-25,78 pollici)
- I ponti di barenatura Jumbo Seco sono realizzati in alluminio ad alta resistenza con interfacce in acciaio e coprono la gamma di diametri 654-2155 mm (25,75-84,843 pollici)

Panoramica

Introduzione

Foratura

Alesatura

Barenatura

Allegato

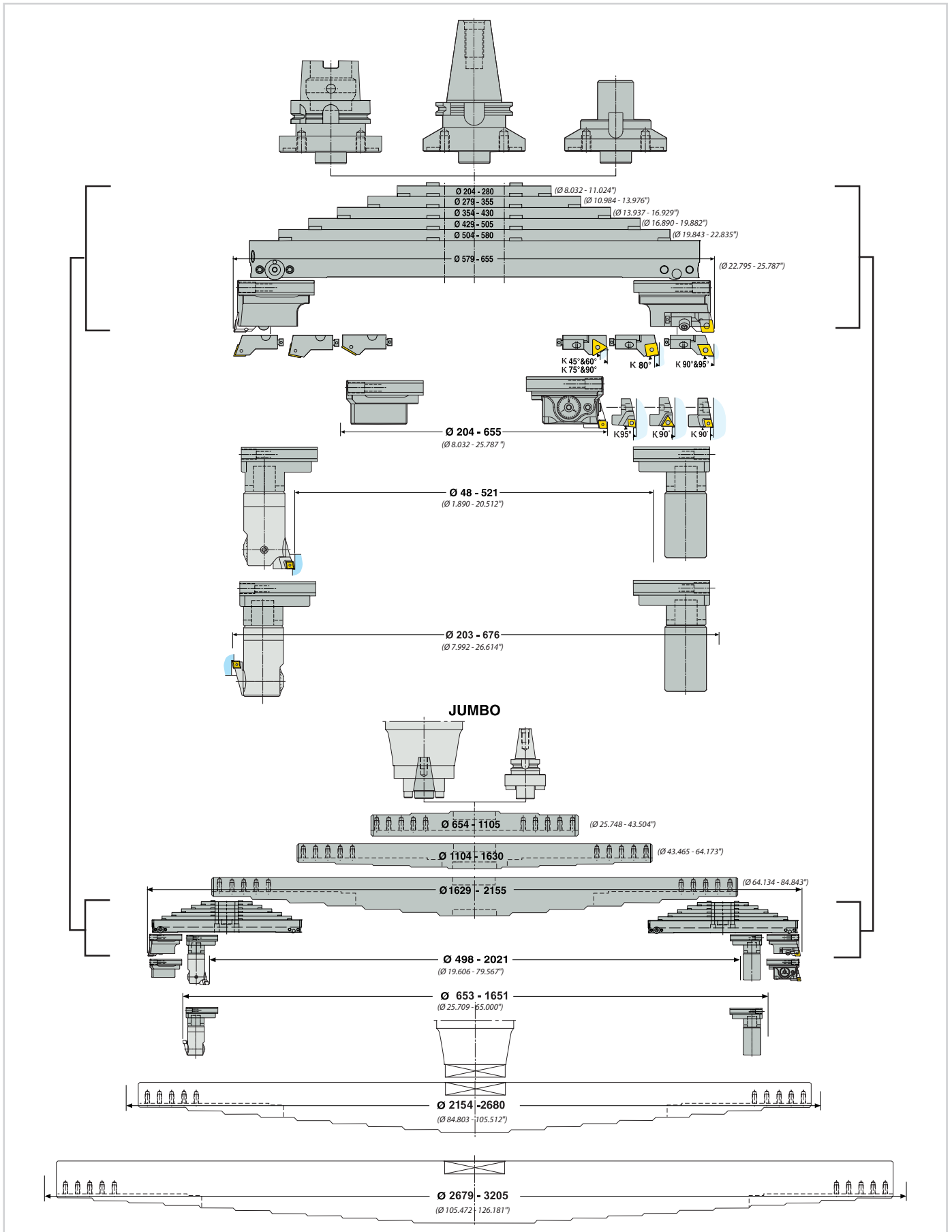

Caratteristiche

5 ponti di barenatura

Ø 654–3205 mm (Ø 25,748–126,181") anche tornitura esterna Ø 498–3071 mm Ø 19,606–120,906") e barenatura in tirata Ø 653–3226 mm (Ø 25,709–127,008").

I ponti Jumbo per barenatura, realizzati in alluminio ad alta resistenza e con connessione mandrino in acciaio, sono progettati per montare due ponti standard in varie posizioni.

Le misure A731S001, 002, 003 sono fornite con 4 viti di bloccaggio per essere montate su un attacco con flangia tipo 569, con centraggio Ø 60 mm (Ø 2,362") o per essere montate direttamente sul mandrino macchina (DIN 2079/50 lato utensile), mediante il centraggio mostrato negli accessori. I ponti di barenatura Jumbo dispongono di due golfari di sollevamento amovibili.

Le misure A731S004-...* e A731S005-...* sono disponibili su richiesta, con possibilità di montaggio standard o specifiche del mandrino, in base alla macchina:

Capacità Ø mm (pollici)	Descrizione	Dimensioni in mm (pollici), vedere il disegno alla pagina prodotto							
		DCB	LF	HTB	LB	CBDP	WB	DCON	Peso
2154-2680 (84.803-105.512")	A731S004-...*	*	70 (2.75591")	300 (11.811")	160 (6.29921")	*	2140 (84.25197")	*	*
2679-3205 (105.472-126.181")	A731S005-...*	*	110 (4.33071")	400 (15.748")	200 (7.87402")	*	2665 (104.9213")	*	*

* Descrizione e dimensioni saranno completati in relazione al tipo di attacco macchina.

Caratteristiche principali dei ponti di barenatura Jumbo

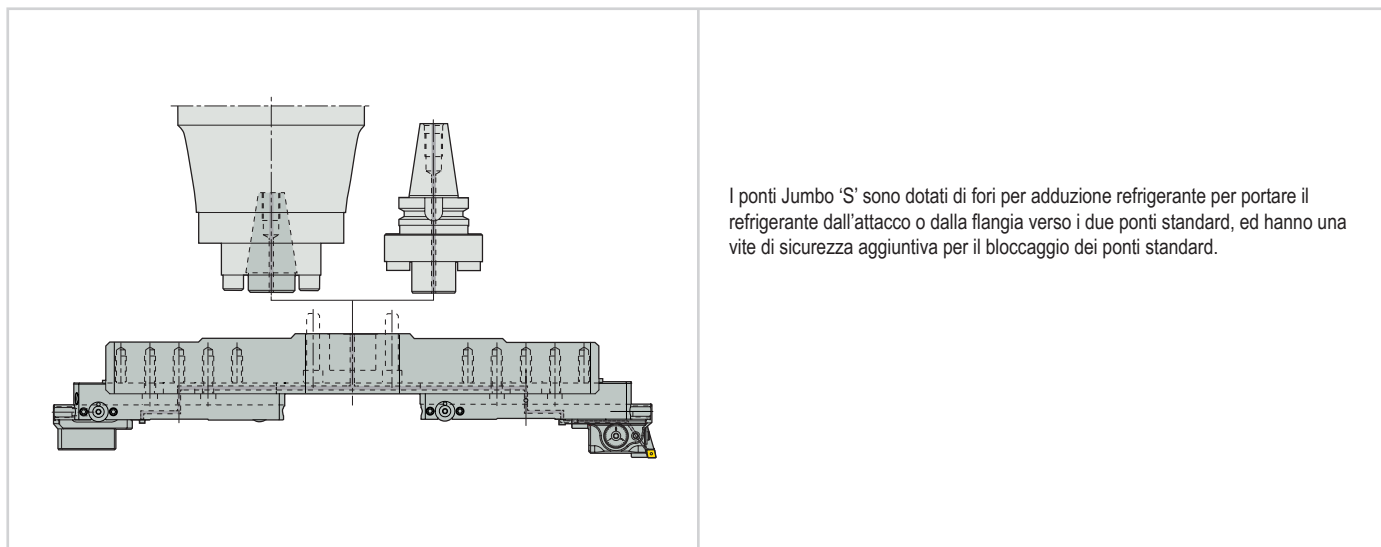

I ponti Jumbo 'S' sono dotati di fori per adduzione refrigerante per portare il refrigerante dall'attacco o dalla flangia verso i due ponti standard, ed hanno una vite di sicurezza aggiuntiva per il bloccaggio dei ponti standard.

Nota! Su questi nuovi ponti di barenatura Jumbo 'S' si possono montare tutti i ponti standard (sia i nuovi 'S' che il tipo precedente senza 'S'): montando ponti di tipo precedente non si può usare la vite di sicurezza aggiuntiva. L'adduzione di refrigerante è possibile solamente usando ponti Jumbo 'S' e ponti standard 'S'. Non montare sullo stesso ponte Jumbo ponti standard ed unità di scorrimento di tipo nuovo e di tipo precedente, al fine di mantenere l'equilibratura.

Caratteristiche

6 ponti di barenatura

Ø 204–655 mm (Ø 8,032–25,787") anche tornitura esterna Ø 48–521 mm (Ø 1,890–20,512") e barenatura in tirata.

I ponti hanno attacco lato macchina Ø 130 mm (Ø 5,118") per il montaggio su adattatori SA o HSK o sull'adattatore Graflex®.

Quando si utilizza l'adattatore Graflex®, è possibile usare delle prolunghe nonché il montaggio sul naso macchina con l'apposita flangia (vedere sistema modulare Graflex®). La posizione angolare del ponte ogni 30° sul supporto sull'adattatore Graflex® facilita lo stoccaggio a magazzino.

Ciascun ponte è adatto per il montaggio di unità di sgrossatura e di finitura o unità di contrappeso Graflex®.

Le unità (di sgrossatura o di finitura) sono bloccate sul ponte per mezzo di due cilindri azionati da tre viti di serraggio. Una delle viti di serraggio ha un disco di arresto, che limita la corsa di scorrimento dell'unità all'interno della sua capacità di impostazione e ferma l'unità impedendole di scivolare fuori dal ponte di barenatura. Scorrimento preciso e rapido dell'unità per una regolazione del diametro di 38 mm (Ø 1,496") di corsa sul raggio, mediante un comodo meccanismo di trascinamento con perno di ritenzione.

Refrigerante interno al ponte ed alle unità di barenatura, diretto verso il tagliente.

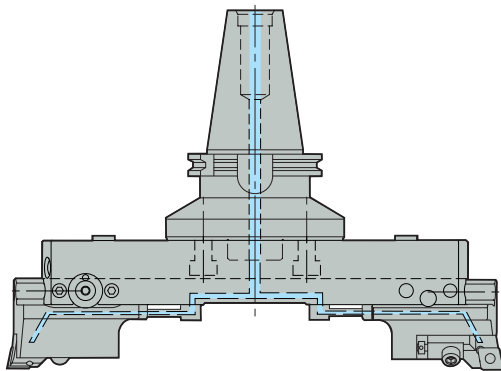

Per la selezione dei ponti di barenatura e dei ponti Jumbo, in funzione del diametro della barenatura, tornitura esterna o barenatura in tirata, vedere le tabelle di selezione dei ponti di barenatura alle pagine 665-670.

Massimo numero di giri al minuto, vedere pagina 676.

Nota! Questi ponti di barenatura (codici di ordinazione A731S 0_0) non sono adatti alle unità di tipo precedente (codici di ordinazione A731 _00, senza S-).

Caratteristiche

Unità per barenatura di sgrossatura

Un ponte di barenatura di sgrossatura bi-tagliente richiede due unità per barenatura di sgrossatura, ognuna dotata di cartuccia. Unità per barenatura di sgrossatura con adduzione refrigerante interna, diretta verso il tagliente.

Quando si utilizza l'adattatore Graflex®, è possibile usare delle prolunghe nonché il montaggio sul naso macchina con l'apposita flangia (vedere sistema modulare Graflex®).

La posizione angolare del ponte ogni 30° sul supporto sull'adattatore Graflex® facilita lo stoccaggio a magazzino.

Ciascun ponte è adatto per il montaggio di unità di sgrossatura e di finitura o unità di contrappeso Graflex®.

Cartucce

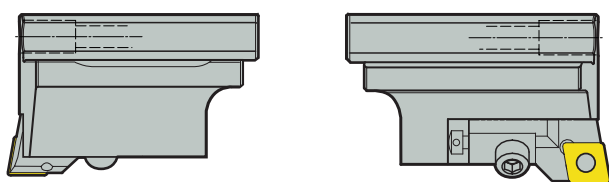

È disponibile una vasta gamma di cartucce:

- Cartucce con angolo d'attacco di 90°, raccomandate nella maggior parte delle applicazioni di barenatura per un minore consumo energetico.
- Cartucce con angolo d'attacco di 80°, raccomandate per i fori passanti (e la smussatura), particolarmente nella ghisa per evitare rotture in uscita. Il consumo energetico è più alto.
- È possibile utilizzare altre cartucce ISO5611/h1 = 16 mm (0,629").

NOTA! Le due cartucce possono essere regolate sullo stesso diametro o in posizione sfalsata. È disponibile come accessorio uno spessore angolare per cartucce (codice di ordinazione 18LS0316). Istruzioni di assemblaggio e di regolazione, vedere le pagine 665-670.

Unità per barenatura di finitura e contrappeso

Per comporre un ponte per barenatura di finitura si devono utilizzare un'unità di finitura, un portainsero ed un contrappeso.

La vite micrometrica delle unità di finitura ha una risoluzione radiale (1 incremento = 5 μm (197 μin) sul diametro).

Il sistema di regolazione è protetto e lubrificato a vita.

La precisione del meccanismo garantisce una ripetibilità accurata. La vite di regolazione è situata sul lato dell'unità per garantire un facile accesso.

Unità per barenatura di finitura con adduzione refrigerante interna, diretta verso il tagliente.

Portainseri per barenatura di finitura A72460, A72560 o A72660 adatti

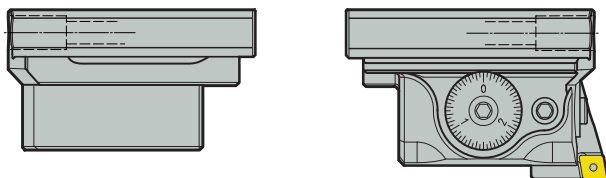

I portainseri di finitura A72460, A72560 o A72660 devono essere ordinati separatamente: sono gli stessi che vengono montati sulle testine per barenatura di finitura radiale (vedere pagina 654, 655).

Istruzioni di assemblaggio e di regolazione, vedere le pagine 665-670.

Caratteristiche

Unità per barenatura Graflex® per tornitura esterna o barenatura in tirata

Questa unità è dotata di una connessione femmina Graflex® G5.

Qualsiasi testina per barenatura Graflex®, utensile speciale, o modulo standard Graflex® di dimensione G5 può essere montato sui ponti, ad esempio il disegno mostra le impostazioni per una tornitura esterna o barenatura in tirata usando due unità Graflex® con testina per barenatura di finitura Graflex® A78050 con portainseri (esempio A72550 per tornitura esterna), portainseri per tornitura esterna (esempio A789X30CC0690) e contrappeso Graflex® (esempio codice BM050W78050).

Sono possibili due posizioni del modulo Graflex® sull'unità, perché sono presenti 2x2 posizioni per le viti a testa sferica e due chiavette per tenone disposte a 180°. Unità e testina per barenatura con adduzione refrigerante interna, diretto verso il tagliente.

Istruzioni di assemblaggio e di regolazione, vedere le pagine 665-670.

Introduzione

Foratura

Alesatura

Barenatura

Allegato

Unità per barenatura Graflex® per tornitura esterna o barenatura in tirata

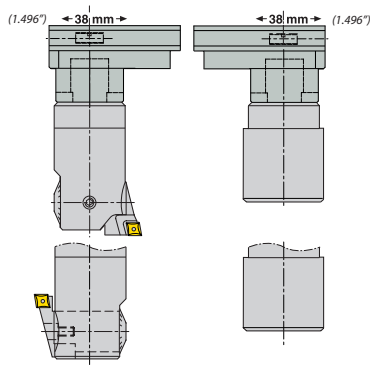

Queste unità di barenatura (codici di ordinazione A731S 400, A731S 500, A731S 600, A731S 40128) possono essere montate sui ponti di tipo precedente (codice di ordinazione A731 0_0, senza S-).

Istruzioni di assemblaggio e massimo numero di giri: sono ancora validi quelli della precedente versione del ponte.

Non montare sullo stesso ponte unità di tipo nuovo e di tipo precedente, al fine di mantenere l'equilibratura.

NOTA! Queste nuove unità di barenatura possono essere montate sui ponti di tipo precedente

Consigli per la scelta degli accessori per l'adduzione interna del refrigerante

Sgrossatura (ponte con 2 unità per barenatura di sgrossatura):

Per dirigere il refrigerante direttamente su entrambi i taglienti, usare 2 tubi di connessione refrigerante (codice di ordinazione AU731S00700), da montare sul ponte, e 2 set di ugelli orientabili (codice di ordinazione AU731S40700), da montare su ciascuna unità per barenatura di sgrossatura. Per l'adduzione del refrigerante dai canali interni delle unità, usare 2 tubi di connessione refrigerante (codice di ordinazione AU731S00700), da montare sul ponte.

Finitura (ponte con 1 unità per barenatura di finitura ed 1 contrappeso):

Usare 1 tubo di connessione refrigerante (codice di ordinazione AU731S00700), da montare sul ponte in modo da connetterlo all'unità di finitura. Poiché le unità di finitura prevedono un ugello di adduzione del refrigerante, l'indirizzamento del refrigerante è direttamente ottenuto.

Tornitura esterna (per esempio ponte di barenatura con 2 unità Graflex® equipaggiate con una testina per barenatura di finitura ed un contrappeso): Usare 1 tubo di connessione refrigerante (codice di ordinazione AU731S00700), da montare sul ponte per connettere l'unità Graflex® e la testina per barenatura. Il canale di adduzione interno all'unità Graflex® porterà il refrigerante nella testina per barenatura



Tubo di connessione refrigerante
(codice di ordinazione AU731S00700)

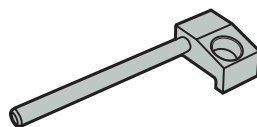

Set di ugelli orientabili
(codice di ordinazione AU731S40700)

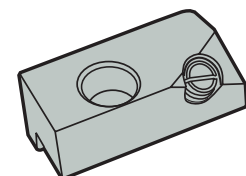

NOTA! Pressione refrigerante consentita = max 70 bar.

Assemblaggio ponti di barenatura

Un assemblato per barenatura di sgrossatura fino a \varnothing 655 mm (\varnothing 25,787") richiede: 1 ponte di barenatura (A731S 0_0) + 2 unità per barenatura di sgrossatura (2x A731S 400) con 2 cartucce*.

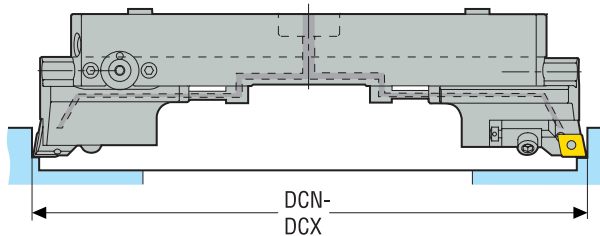

Fig. 1

Un assemblato per barenatura di finitura fino a \varnothing 655 mm (\varnothing 25,787") richiede: 1 ponte di barenatura (A731S 0_0) + 1 unità per barenatura di finitura (A731S 500) con 1 portainsero per barenatura di finitura dimensione 60** + 1 contrappeso (A731S 600).

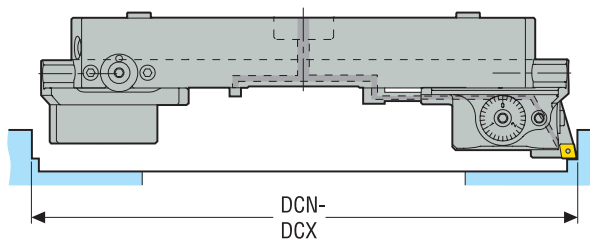

Fig. 2

Un assemblato per barenatura di sgrossatura fino a \varnothing 3205 mm (\varnothing 126,181") richiede: 1 ponte Jumbo (A731S 00_) + 2 ponti di barenatura (A731S 0_0) + 2 unità per barenatura di sgrossatura (2x A731S 400) con 2 cartucce*.

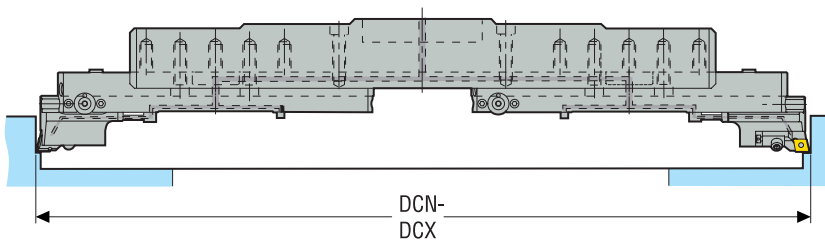

Fig. 3

Un assemblato per barenatura di finitura fino a \varnothing 3205 mm (\varnothing 126,181") richiede: 1 ponte Jumbo (A731S 00_) + 2 ponti di barenatura (A731S 0_0) + 1 unità per barenatura di finitura (A731S 500) con 1 portainsero per barenatura di finitura dimensione 60** + 1 contrappeso (A731S 600).

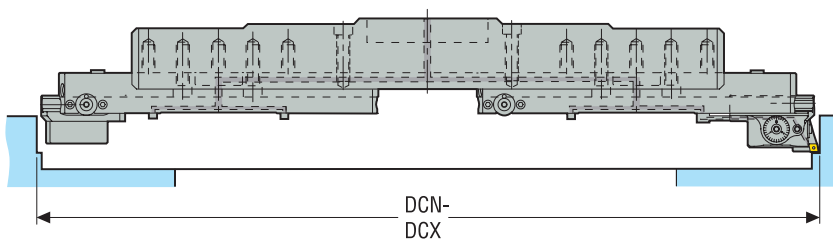

Fig. 4

* Cartucce da ordinare a parte.

** Portainseri da ordinare a parte.

Assemblaggio ponti di barenatura:

Tabella di selezione ponti di barenatura per creare un diametro di BARENATURA richiesto

Per barenatura DCN-DCX Ø mm	Per barenatura DCN-DCX Ø inch	Ponte di barenatura Jumbo	Ponte(i) tradizionale(i)	Per barenatura di sgrossatura		Per barenatura di finitura	
				Fig.	Fig.		
204-280	8.031-11.024	-	A731S 010	2x A731S 400 + 2 cartucce	1	A731S 500 + 1 porta-inserito + A731S 600	2
279-355	10.984-13.976	-	A731S 020				
354-430	13.937-16.929	-	A731S 030				
429-505	16.890-19.882	-	A731S 040				
504-580	19.843-22.835	-	A731S 050				
579-655	22.795-25.787	-	A731S 060				
654-805	25.748-31.693	A731S 001	2x A731S 010	2x A731S 400 + 2 cartucce	3	A731S 500 + 1 porta-inserito + A731S 600	4
654-880	25.748-34.646		2x A731S 020				
804-955	31.654-37.598		2x A731S 030				
879-1030	34.606-40.551		2x A731S 040				
1029-1105	40.512-43.504		2x A731S 050				
1104-1255	43.465-49.409	A731S 002	2x A731S 010	2x A731S 400 + 2 cartucce	3	A731S 500 + 1 porta-inserito + A731S 600	4
1104-1330	43.465-52.362		2x A731S 020				
1179-1405	46.417-55.315		2x A731S 030				
1254-1480	49.370-58.268		2x A731S 040				
1329-1555	52.323-61.220		2x A731S 050				
1404-1630	55.276-64.173		2x A731S 060				
1629-1780	64.134-70.079		2x A731S 010				
1629-1855	64.134-73.031	2x A731S 020	2x A731S 400 + 2 cartucce	3	A731S 500 + 1 porta-inserito + A731S 600	4	
1704-1930	67.087-75.984	2x A731S 030					
1779-2005	70.039-78.937	2x A731S 040					
1854-2080	72.992-81.890	2x A731S 050					
1929-2155	75.945-84.843	2x A731S 060					
2154-2305	84.803-90.748	A731S 004	2x A731S 010	2x A731S 400 + 2 cartucce	3	A731S 500 + 1 porta-inserito + A731S 600	4
2154-2380	84.803-93.701		2x A731S 020				
2229-2455	87.756-96.654		2x A731S 030				
2304-2530	90.709-99.606		2x A731S 040				
2379-2605	93.661-105.512		2x A731S 050				
2454-2680	96.614-105.512		2x A731S 060				
2679-2830	105.472-111.417		2x A731S 010				
2679-2905	105.472-114.370	2x A731S 020					
2754-2980	108.425-117.323	2x A731S 030					
2829-3055	111.378-120.276	2x A731S 040					
2904-3130	114.331-123.228	2x A731S 050					
2979-3205	117.283-126.181	2x A731S 060					

Introduzione

Foratura

Alesatura

Barenatura

Allegato

Assemblaggio ponti di barenatura per tornitura esterna:

Un assemblato per tornitura esterna di finitura fino a $\varnothing 521 \text{ mm}$ ($\varnothing 20,512''$) richiede: 1 ponte di barenatura (A731S 0_0) + 2 unità Graflex® (2x A731S 40128) + ad es. 1 testina per barenatura di finitura (A780 50) con 1 portainsero per barenatura di finitura dimensione 60* + 1 contrappeso (BM050W78050).

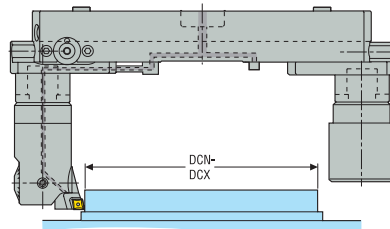

Fig. 1

Un assemblato per barenatura di sgrossatura fino a $\varnothing 3205 \text{ mm}$ ($\varnothing 120,906''$) richiede: 1 ponte Jumbo (A731S 00_) + 2 ponti di barenatura (A731S 0_0) + 2 unità per barenatura di sgrossatura (2x A731S 400) con 2 cartucce*.

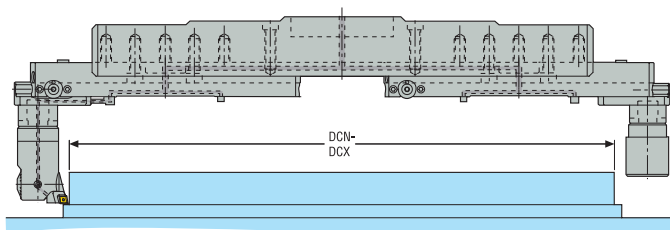

Fig. 2

* Portainseri da ordinare separatamente.

Assemblaggio ponti di barenatura per tornitura esterna: Tabella di selezione ponti di barenatura per creare un diametro di tornitura esterna richiesto

Per tornitura esterna DCN-DCX Ø mm	Per tornitura esterna DCN-DCX Ø inch	Ponte di barenatura Jumbo	Ponte(i) tradizionale(i)	Per tornitura esterna di finitura	Fig.
48-146	1.890-5.748	-	A731S 010	2x A731S 40128 + 1x A780 50 + 1 porta-inserto + 1x BM050W78050	1
123-221	4.843-8.701	-	A731S 020		
198-296	7.795-11.654	-	A731S 030		
273-371	10.748-14.606	-	A731S 040		
348-446	13.701-17.559	-	A731S 050		
423-521	16.654-20.512	-	A731S 060		
498-671	19.606-26.417	A731S 001	2x A731S 010	2x A731S 40128 + 1x A780 50 + 1 porta-inserto + 1x BM050W78050	2
498-746	19.606-29.370		2x A731S 020		
648-821	25.512-32.323		2x A731S 030		
723-896	28.465-35.276		2x A731S 040		
873-971	34.370-38.228		2x A731S 050		
948-1121	37.323-44.134	A731S 002	2x A731S 010	2x A731S 40128 + 1x A780 50 + 1 porta-inserto + 1x BM050W78050	2
948-1196	37.323-47.087		2x A731S 020		
1098-1271	43.228-50.039		2x A731S 030		
1173-1346	46.181-52.992		2x A731S 040		
1323-1421	52.087-55.945		2x A731S 050		
1398-1496	55.039-58.898		2x A731S 060		
1473-1646	57.992-64.803		A731S 003		
1473-1721	57.992-67.756	2x A731S 020			
1623-1796	63.898-70.709	2x A731S 030			
1698-1871	66.850-73.661	2x A731S 040			
1848-1946	72.756-76.614	2x A731S 050			
1923-2021	75.709-79.567	2x A731S 060			
1998-2171	78.661-85.472	A731S 004	2x A731S 010	2x A731S 40128 + 1x A780 50 + 1 porta-inserto + 1x BM050W78050	2
1998-2246	78.661-88.425		2x A731S 020		
2148-2321	84.567-91.378		2x A731S 030		
2223-2396	87.520-94.331		2x A731S 040		
2373-2471	93.425-97.283		2x A731S 050		
2448-2546	96.378-100.236		2x A731S 060		
2523-2696	99.331-106.142		A731S 005		
2523-2771	99.331-109.094	2x A731S 020			
2973-2846	117.047-112.047	2x A731S 030			
2748-2921	108.189-115.000	2x A731S 040			
2898-2996	114.094-117.953	2x A731S 050			
2973-3071	117.047-120.906	2x A731S 060			

Assemblaggio ponti per barenatura in tirata:

Un assemblato per barenatura di finitura in tirata fino a $\varnothing 676$ mm ($\varnothing 26,614$ ") richiede: 1 ponte di barenatura (A731S 0_0) + 2 unità Graflex® (2x A731S 40128) + ad es. 1 testina per barenatura di finitura (A780 50) con 1 portainsero per barenatura in tirata dimensione 50* + 1 contrappeso (BM050W78050).

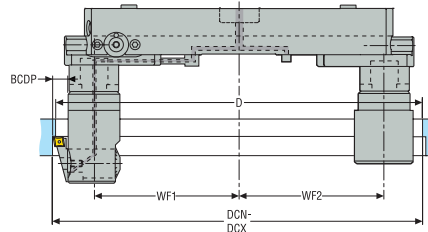

Fig. 1

Un assemblato per barenatura di finitura in tirata fino a $\varnothing 3226$ mm ($\varnothing 127,008$ ") richiede: 1 ponte di barenatura Jumbo (A731S 00_) + 2 ponti di barenatura (A731S 0_0) + ad es. 1 testina per barenatura di finitura (A780 50) con 1 portainsero per barenatura in tirata dimensione 50* + 1 contrappeso (BM050W78050).

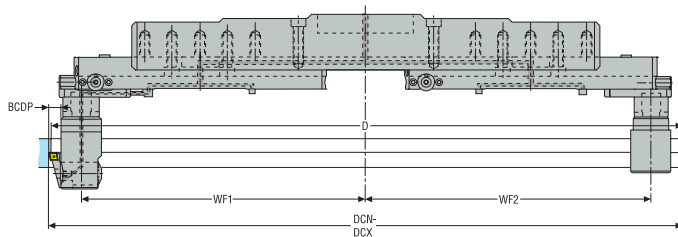

Fig. 2

* Portainseri da ordinare separatamente.

Determinazione del diametro minimo di accesso (D min)

Condizione di equilibratura: $WF1 = WF2$

$$D \text{ min} = DC + 5 - BCDP$$

BCDP = distanza tra il tagliente dell'insero ed il corpo della testina per barenatura montata A78050 ($7,5 < BCDP < 18,5$).

Due casi estremi:

Testina per barenatura A78050 impostata alla capacità minima: $D \text{ min} = DCN - 2,5$
 Testina per barenatura A78050 impostata alla capacità massima: $D \text{ min} = DCX - 13,5$

Assemblaggio ponti per barenatura in tirata: Tabella di selezione ponti di barenatura per creare un diametro di BARENATURA IN TIRATA richiesto

Per barenatura in tirata DCN-DCX Ø mm	Per barenatura in tirata DCN-DCX Ø inch	Ponte di barenatura Jumbo	Ponte(i) tradizionale(i)	Per barenatura in tirata di finitura	Fig.
203-301	7.992-11.850	-	A731S 010	2x A731S 40128 + 1x A780 50 + 1 portainseriti per barenatura in tirata + 1x BM050W78050	1
278-376	10.945-14.803	-	A731S 020		
353-451	13.898-17.756	-	A731S 030		
428-526	16.850-20.709	-	A731S 040		
503-601	19.803-23.661	-	A731S 050		
578-676	22.756-26.614	-	A731S 060		
653-826	25.709-32.520	A731S 001	2x A731S 010	2x A731S 40128 + 1x A780 50 + 1 portainseriti per barenatura in tirata + 1x BM050W78050	2
653-901	25.709-35.472		2x A731S 020		
803-976	31.614-38.425		2x A731S 030		
878-1051	34.567-41.378		2x A731S 040		
1028-1126	40.472-44.331		2x A731S 050		
1103-1276	43.425-50.236	A731S 002	2x A731S 010	2x A731S 40128 + 1x A780 50 + 1 portainseriti per barenatura in tirata + 1x BM050W78050	2
1103-1351	43.425-53.189		2x A731S 020		
1253-1426	49.331-56.142		2x A731S 030		
1328-1501	52.283-59.094		2x A731S 040		
1478-1576	58.189-62.047		2x A731S 050		
1553-1651	61.142-65.000		2x A731S 060		
1628-1801	64.094-70.906	A731S 003	2x A731S 010	2x A731S 40128 + 1x A780 50 + 1 portainseriti per barenatura in tirata + 1x BM050W78050	2
1628-1876	64.094-73.858		2x A731S 020		
1778-1951	70.000-76.811		2x A731S 030		
1853-2026	72.953-79.764		2x A731S 040		
2003-2101	78.858-82.717		2x A731S 050		
2078-2176	81.811-85.669		2x A731S 060		
2153-2326	84.764-91.575	A731S 004	2x A731S 010	2x A731S 40128 + 1x A780 50 + 1 portainseriti per barenatura in tirata + 1x BM050W78050	2
2153-2401	84.764-94.528		2x A731S 020		
2303-2476	90.669-97.480		2x A731S 030		
2378-2551	93.622-100.433		2x A731S 040		
2528-2626	99.528-103.386		2x A731S 050		
2603-2701	102.480-106.339		2x A731S 060		
2678-2851	105.433-112.244	A731S 005	2x A731S 010	2x A731S 40128 + 1x A780 50 + 1 portainseriti per barenatura in tirata + 1x BM050W78050	2
2678-2926	105.433-115.197		2x A731S 020		
2828-3001	111.339-118.150		2x A731S 030		
2903-3076	114.291-121.102		2x A731S 040		
3053-3151	120.197-124.055		2x A731S 050		
3128-3226	123.150-127.008		2x A731S 060		

ABB 731 200 – Attacchi e adattatore per ponte di barenatura

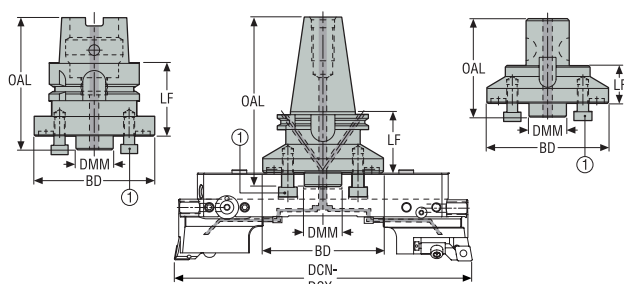

1. Vite di regolazione

- Attacchi HSK e SA per assemblati corti
- Adattatore Graflex® per assemblati lunghi
- Posizione angolare del ponte di barenatura ogni 30°
- Fornito con un O-ring di tenuta del mandrino $\varnothing 58 \times 3$ mm



Codice di ordinazione	Codice prodotto	Connessione lato macchina	Dimensione	Lato utensile		OAL	LF	BD	DMM	Peso
				Capacità	DCN-DCX \varnothing					
				mm	mm	mm	mm	mm	mm	kg
				Inch	Inch	Inch	Inch	Inch	Inch	lb
E3471731200	02503392	DIN 69871-ADB	DIN50 ADB	204,0 8.031	655,0 25.787	166,75 6.565	65,0 2.559	130,0 5.118	40,0 1.575	5,9 13.010
E3416731200	02503393	BT JIS B 6339-ADB	BT50 ADB	204,0 8.031	655,0 25.787	166,75 6.565	65,0 2.559	130,0 5.118	40,0 1.575	5,64 12.430
E9306731200	02417268	ISO 12164-1/ DIN69893-A	HSK-A100	204,0 8.031	655,0 25.787	115,0 4.528	65,0 2.559	130,0 5.118	40,0 1.575	5,0 11.020
A731200	00056616	GRAFLEX	G7	204,0 8.031	655,0 25.787	90,0 3.543	40,0 1.575	130,0 5.118	40,0 1.575	4,0 8.820

Coppia di serraggio 80 Nm. Per ulteriori dettagli sull'applicazione, fare riferimento alle istruzioni operative fornite con i ponti di barenatura e relative unità.

Parti di ricambio, comprese nella fornitura

Per	Vite di assemblaggio	Chiave	Sealing Screws	Tenone
E3471731200	950D1230	10SMS795	950A0606	-
E3416731200	950D1230	10SMS795	950A0606	-
E9306731200	950D1230	10SMS795	-	-
A731200	950D1230	10SMS795	-	90M7

Accessori

Per	Connettore refrigerante	Grani di tenuta	Chiave
E3471731200	-	-	-
E3416731200	-	-	-
E9306731200	20E9306	02E9306	03E9306
A731200	-	-	-

BB 731S0x0 – Ponte di barenatura

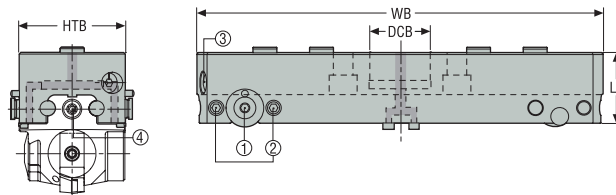

- Refrigerante attraverso il ponte di barenatura

1. Vite di bloccaggio con disco di arresto
2. Vite di bloccaggio
3. Perno di sicurezza
4. Vite di regolazione del diametro

Codice di ordinazione	Codice prodotto	Lato utensile Capacità DCN-DCX Ø		HTB	WB	DCB	LF	Peso
		mm Inch	mm Inch					
A731S010	02753664	204,0 8.031	280,0 11.024	70,0 2.756	195,0 7.677	40,0 1.575	47,0 1.850	3,6 7.940
A731S020	02753668	279,0 10.984	355,0 13.976	70,0 2.756	269,0 10.591	40,0 1.575	47,0 1.850	5,0 11.020
A731S030	02753670	354,0 13.937	430,0 16.929	70,0 2.756	344,0 13.543	40,0 1.575	47,0 1.850	6,5 14.330
A731S040	02753673	429,0 16.890	505,0 19.882	70,0 2.756	419,0 16.496	40,0 1.575	47,0 1.850	7,9 17.420
A731S050	02753675	504,0 19.843	580,0 22.835	70,0 2.756	494,0 19.449	40,0 1.575	47,0 1.850	10,5 23.150
A731S060	02753677	579,0 22.795	655,0 25.787	70,0 2.756	569,0 22.402	40,0 1.575	47,0 1.850	12,3 27.120

Coppia di serraggio delle viti di bloccaggio (2) e della vite di bloccaggio con disco di arresto (1): 20 Nm

Prima della regolazione del diametro, assicurarsi che il perno di fissaggio sia inserito. Per ulteriori dettagli sull'applicazione, fare riferimento alle istruzioni operative fornite con i ponti di barenatura e relative unità.

Massimo numero di giri al minuto, vedere le pagine. 676 *Per le capacità di tornitura esterna, vedere le pagine della guida 667-668

Per diametri più ampi, vedere i ponti di barenatura Jumbo alle pagine 673

Parti di ricambio, comprese nella fornitura

Per	Vite di bloccaggio
A731S010-60	19A71060

Accessori

Per	Chiave (impugnatura a T)	Chiave	Chiave di bloccaggio
A731S010-60	DOUBLE-T	H6B-H5.0L	03HL05

JBB 731S00 – Ponti di barenatura Jumbo

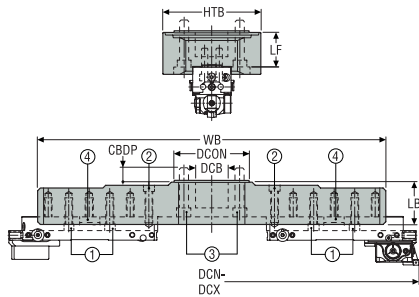

1. Vite di assemblaggio
2. Vite di bloccaggio
3. Vite di fissaggio
4. Grano di tenuta

- I ponti di barenatura Jumbo sono progettati per montare due ponti di barenatura classici in diverse posizioni
- Ponti di barenatura Jumbo con adduzione refrigerante interna

Codice di ordinazione	Codice prodotto	Lato utensile		HTB	LF	WB	DCON	DCB	CDBP	LB	Peso	**
		Capacità	DCN-DCX Ø									
		mm	mm	mm	mm	mm	mm	mm	mm	mm	kg	
		Inch	Inch	Inch	Inch	Inch	Inch	Inch	Inch	Inch	lb	
A731S001	02828506	654,0 25.748	1105,0 43.504	180,0 7.087	63,0 2.480	640,0 25.197	135,0 5.315	60,0 2.362	24,0 0.945	77,0 3.031	20,25 44.640	-
A731S002	02828516	1104,0 43.465	1630,0 64.173	200,0 7.874	50,0 1.969	1090,0 42.913	135,0 5.315	60,0 2.362	24,0 0.945	80,0 3.150	34,5 76.060	-
A731S003	02904383	1629,0 64.134	2155,0 84.843	200,0 7.874	50,0 1.969	1615,0 63.583	135,0 5.315	60,0 2.362	24,0 0.945	80,0 3.150	67,0 147.710	**

Capacità di barenatura, tornitura esterna e barenatura in tirata per combinazioni di Jumbo e ponti di barenatura, vedere le pagine 665-670

**Dimensioni maggiori A731S004... (Ø 2154-2680 mm) e A731S005... (Ø 2679-3205 mm) disponibilità su richiesta, vedere le pagine della guida 661

Parti di ricambio, comprese nella fornitura

Accessori

Per DCN-DCX	Vite di assemblaggio	Vite di fissaggio	Vite leva	Vite di bloccaggio	O-ring	Grani di tenuta	Spina di centraggio
654-1105	950D1240	950D1670	90AS03	950D1250	90JT02	AU731S01100	E447153960
1104-1630	950D1240	950D1680	90AS03	950D1250	90JT02	AU731S01100	E447153960
1629-2155	950D1240	950D16120	90AS03	950D1250	90JT02	AU731S01100	E447153960

Il set di anelli di tenuta contiene 6 anelli di tenuta Ø 6 mm (0.236") per i canali di adduzione del refrigerante ed 1 anello di tenuta Ø 60 mm (2.362") per il foro di bloccaggio del ponte Jumbo.

BBB 731S0xx – Per unità di barenatura e ponti di barenatura Jumbo

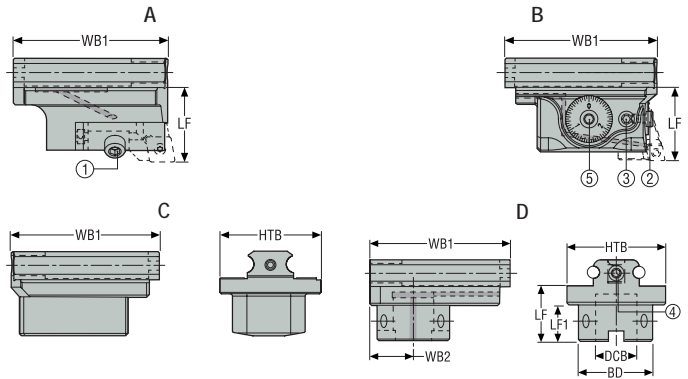

- Per il montaggio su ponti di barenatura
- Unità di barenatura di sgrossatura, finitura e Graflex con adduzione refrigerante interna

1. Vite di assemblaggio
5. Vite di regolazione micrometrica
3. Vite di bloccaggio

2. Vite di assemblaggio
4. Vite di regolazione del diametro

Codice di ordinazione	Codice prodotto	Tipo di unità di scorrimento	Lato utensile		DCB	BD	WB1	WB2	LF	LF1	HTB	Peso	Disegno
			Capacità DCN-DCX	Ø									
			mm	mm	mm	mm	mm	mm	mm	mm	mm	kg	
			Inch	Inch	Inch	Inch	Inch	Inch	Inch	Inch	Inch	lb	
A731S400	02753679	Unità per barenatura di sgrossatura*	204,0	2155,0	-	-	97,0	-	47,0	-	70,0	1,4	A
			8.031	84.843			3.819		1.850		2.756	3.090	
A731S500	02753680	Unità per barenatura di finitura**	204,0	2155,0	-	-	97,0	-	47,0	-	70,0	1,5	B
			8.031	84.843			3.819		1.850		2.756	3.310	
A731S600	02753682	Contrappeso	204,0	2155,0	-	-	97,0	-	-	-	70,0	1,6	C
			8.031	84.843			3.819				2.756	3.530	
A731S40128	02753687	Graflex dimensione G5***	48,0	2021,0	28,0	50,0	97,0	30,0	36,0	25,0	70,0	1,0	D
			1.890	79.567	1.102	1.969	3.819	1.181	1.417	0.984	2.756	2.200	

* Cartucce da ordinare a parte, vedere le pagine 675

** Portainseri per barenatura di finitura dimensione 60 da ordinare a parte, vedere pagina 654, 655

*** Con la testa di barenatura A78050, utilizzare il contrappeso BM050W78050, vedere la sezione Accessori di seguito.

Parti di ricambio, comprese nella fornitura

Per	Vite di assemblaggio	Vite di bloccaggio cilindro	Chiave (impugnatura a T)	Chiave	Chiave di bloccaggio	O-ring
A731S400	950CB0830	-	DOUBLE-T	H6B-H5.0L	-	90JT01
A731S500	950D0612	950L1016	DOUBLE-T	H6B-H5.0L	-	90JT01
A731S600	-	-	DOUBLE-T	H6B-H5.0L	-	-
A731S40128	90F5	-	DOUBLE-T	H6B-H5.0L	03H05	90JT01

Il set di anelli di tenuta contiene 6 anelli di tenuta Ø 6 mm (0.236") per i canali di adduzione del refrigerante ed 1 anello di tenuta Ø 60 mm (2.362") per il foro di bloccaggio del ponte Jumbo.

Accessori

Per	Tubo di connessione	Kit refrigerante	Spessore angolare	Contrappeso
A731S400	AU731S00700	AU731S40700	18LS0316	-
A731S500	AU731S00700	-	-	-
A731S600	-	-	-	-
A731S40128	AU731S00700	-	-	BM050W78050

Cartucce, per barenatura di sgrossatura e ponti di barenatura A731S400

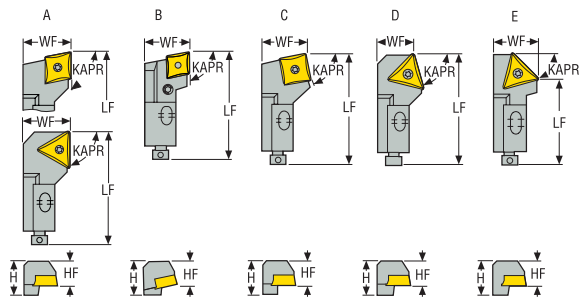

- Per il montaggio su unità di barenatura di sgrossatura

Codice di ordinazione	Codice prodotto	KAPR°	LF	WF	H	HF	Peso	Dimensione inserto	Disegno
			mm Inch	mm Inch	mm Inch	mm Inch			
SCGCL16CA-16	00039871	90	55,0 2.165	25,0 0.984	20,0 0.787	16,0 0.630	0,1 0.220	CC..16..	A
STGCL16CA-16	00009197	90	63,0 2.480	24,96 0.983	25,0 0.984	16,0 0.630	0,2 0.440	TC..16T3..	A
STGCL16CA-22	02600181	90	55,0 2.165	25,0 0.984	20,0 0.787	16,0 0.630	0,2 0.440	TC..2204..	A
PCGNL16CA-12	02484356	90	63,0 2.480	25,0 0.984	25,0 0.984	16,0 0.630	0,2 0.440	CN..12..	B
SSRCL16CA-15	00039872	75	63,0 2.480	25,0 0.984	20,0 0.787	16,0 0.630	0,2 0.440	SC..15..	C
STRCL16CA-16	00008750	75	63,0 2.480	24,96 0.983	25,0 0.984	16,0 0.630	0,2 0.440	TC..16T3..	D
STRCL16CA-22	02585320	75	63,0 2.480	25,0 0.984	20,0 0.787	16,0 0.630	0,2 0.440	TC..2204..	D
STTCL16CA-16	00009194	60	63,0 2.480	14,96 0.589	25,0 0.984	16,0 0.630	0,2 0.440	TC..16T3..	D
STSCL16CA-16	00009193	45	53,0 2.087	24,96 0.983	25,0 0.984	16,0 0.630	0,2 0.440	TC..16T3..	E

Per i ricambi delle cartucce, vedere il catalogo di Tornitura

Condizioni di lavorazione consigliate

Le migliori prestazioni si ottengono utilizzando un liquido di raffreddamento (parametri di lavorazione più elevati, migliore finitura superficiale, migliore evacuazione di truciolo).

In funzione delle necessità, nella barenatura di sgrossatura è possibile: elevato avanzamento o elevata asportazione di truciolo utilizzando la regolazione simmetrica delle cartucce (il metodo più comune, doppio avanzamento rispetto alla regolazione a gradino), oppure regolazione a gradino (doppia profondità di taglio). Nella barenatura di finitura di acciaio, con buone condizioni, raccomandiamo l'uso d'inserti Cermet, per velocità di taglio superiori e maggiore durata.

Per istruzioni dettagliate, fare riferimento alle istruzioni operative fornite con le testine di barenatura e con le barre Steadyline®. Le istruzioni operative possono anche essere scaricate da www.secotools.com.

Risoluzione dei problemi

Fare riferimento alle pagine "Problemi e soluzioni" del capitolo barenatura di sgrossatura, pagina 598, o del capitolo barenatura di finitura, pagina 643.

Velocità massime per i ponti

A causa delle grandi dimensioni delle testine dei ponti di barenatura, la programmazione di un numero di giri non idoneo potrebbe causare gravi danni. Qui di seguito sono riportate le massime velocità di taglio per gli attuali ponti di barenatura ottenuti assemblando ponti di barenatura in acciaio (codice di ordinazione A731S 0_0), unità per barenatura di sgrossatura, di finitura e contrappeso (codice di ordinazione A731S_00) e ponti Jumbo (codice di ordinazione A731 00_). Per assemblaggi differenti rivolgersi al funzionario Seco di zona.

NOTA! Usando le attuali unità di barenatura (codici di ordinazione A731S 400, A731S 500, A731S 600, A731S 40128) sui ponti di barenatura in acciaio della versione precedente (codice di ordinazione A731 0_0, senza S), il valore massimo del numero di giri è come previsto per i ponti di barenatura in acciaio della versione precedente. Non montare sullo stesso ponte teste di tipo nuovo e di tipo precedente, al fine di mantenere l'equilibratura.

Testa basata su	Capacità Ø mm (pollici)	Max. num. di giri	Velocità di taglio massima consigliata v_c alla cap. min. m/min (sf/min)	Velocità di taglio massima consigliata v_c alla cap. max. m/min (sf/min)
Teste per ponti di barenatura (con due unità di scorrimento posizionate simmetricamente)				
A731S010	204-280 (8.0315-11.0236*)	1600	1025 (3363)	1407 (4616)
A731S020	279-355 (10.9843-13.9764*)	1150	1007 (3304)	1282 (4206)
A731S030	354-430 (13.937-16.9291*)	900	1000 (3281)	1215 (3986)
A731S040	429-505 (16.8898-19.8819*)	750	1010 (3314)	1189 (3901)
A731S050	504-580 (19.8425-22.8346*)	650	1029 (3376)	1184 (3885)
A731S060	579-655 (22.7953-25.7874*)	550	1000 (3281)	1131 (3711)
Ponti Jumbo (con due ponti identici e unità di scorrimento posizionate simmetricamente)				
A731S001	654-1105 (25.748-43.50394*)	170	349 (1145)	590 (1936)
A731S002	1104-1630 (43.46457-64.17323*)	100	346 (1135)	512 (1680)
A731S003	1629-2155 (64.13386-84.84252*)	70	358 (1175)	473 (1552)
A731S004	2154-2680 (84.80315-105.5118*)	50	358 (1175)	420 (1378)
A731S005	2679-3205 (105.4724-126.1811*)	40	336 (1102)	402 (1319)

Nota: Le velocità massime dipendono dalla struttura meccanica delle teste di barenatura e dalla qualità di equilibratura. Le velocità massime sono correlate alla struttura meccanica della testa di barenatura e alla qualità di equilibratura. Le velocità all'interno di questi limiti devono essere scelte in funzione delle altre condizioni di lavorazione, esempio materiale del pezzo da lavorare, tagliente (inserto), lunghezza utensile, mandrino macchina.

Soluzioni di barenatura personalizzate

Seco Tools Sistemi di Utensili ha una solida esperienza nella progettazione di soluzioni personalizzate per operazioni di barenatura:



- Soluzioni Steadyline® con smorzamento delle vibrazioni per applicazioni di sgrossatura e di finitura
- Barre di barenatura multi-tagliente
- Prolunghe speciali con pattini di guida, per operazioni con lunghe sporgenze
- Barre combinate per operazioni di foratura, barenatura, smussatura, alesatura e filettatura...

Per maggiori informazioni rivolgersi al funzionario Seco di zona.

Selezione di inserti per barenatura

Questa è una selezione di inserti dalla gamma completa Seco, particolarmente idonei per la barenatura. Le dimensioni degli inserti selezionate devono essere quelle idonee per la gamma di testine per barenatura. Gli inserti per barenatura di sgrossatura hanno un'elevata tenacità per garantire una buona asportazione, e geometrie positive al fine di ridurre al minimo la richiesta di coppia al mandrino.

Gli inserti per barenatura di finitura hanno geometrie positive e taglienti resistenti all'usura per il controllo accurato della tolleranza di barenatura, della geometria e della finitura superficiale.



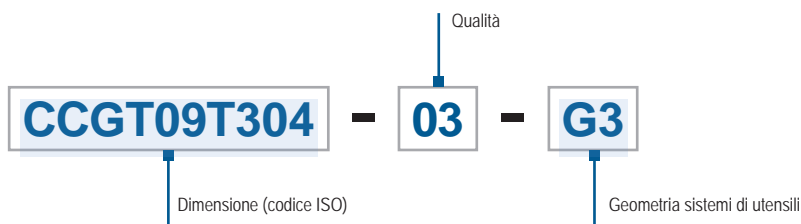
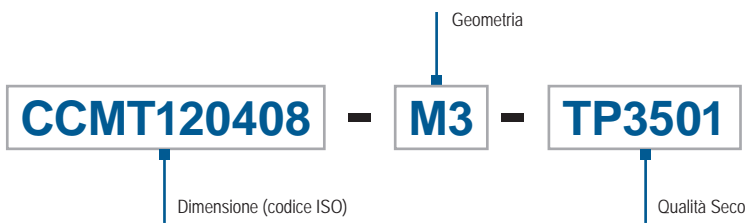







Chiavi di codifica, esempi





Qualità inserto per barenatura – Classificazione ISO dei materiali

		P					M				K				N			S			H									
		P01	P10	P20	P30	P40	P50	M01	M10	M20	M30	M40	K01	K10	K20	K30	K40	N01	N10	N20	N30	S01	S10	S20	S30	H01	H10	H20	H30	
CVD	TP1501	○	○	○	○	○							○	○	○	○														
	TP2501	○	○	○	○	○							○	○	○	○														
	TP3501	○	○	○	○	○							○	○	○	○														
	TP25	○	○	○	○	○							○	○	○	○														
	TP40	○	○	○	○	○							○	○	○	○														
	TM2501	○	○	○	○	○							○	○	○	○														
	TK1501	○	○	○	○	○							○	○	○	○														
PVD	TK0501	○	○	○	○	○						○	○	○	○															
	TH1500	○	○	○	○	○						○	○	○	○															
	25	○	○	○	○	○						○	○	○	○															
	TS2000	○	○	○	○	○						○	○	○	○							○	○	○						
Senza rivestimento	TH1000	○	○	○	○	○						○	○	○	○															
	CP500	○	○	○	○	○						○	○	○	○							○	○	○						
	26	○	○	○	○	○						○	○	○	○															
Cermet	KX	○	○	○	○	○						○	○	○	○															
	HX	○	○	○	○	○						○	○	○	○															
	03	○	○	○	○	○						○	○	○	○															
PCBN	TP1020	○	○	○	○	○						○	○	○	○															
	TP1030	○	○	○	○	○						○	○	○	○															
	51	○	○	○	○	○						○	○	○	○															
PCD	CBN10																					○	○	○						
	CBN010																						○	○	○					
	CBN200																						○	○	○					
	81																													
	CBN060K																													
	PCD20																													
	91																													



Le qualità rivestite CVD sono consigliate per la barenatura

TP1501		Qualità rivestita con tecnologia Duratomic®. Qualità estremamente resistente al calore e all'usura, particolarmente adatta per la tornitura generica di acciai e valida alternativa per altri gruppi materiale. Ti(C,N) + Al ₂ O ₃ + ...	Introduzione	
TP25		Qualità con alta resistenza all'usura e con tagliente tenace, con vasto campo applicativo per tornitura di acciai, acciai inossidabili e ghise. Un'alternativa affidabile a velocità di taglio ridotte o per superfici con elevati requisiti di finitura superficiale. Ti(C,N) + Al ₂ O ₃ + Rilevamento del tagliente usurato (Chrome)		
TP2501		Qualità rivestita con tecnologia Duratomic®. Progettata con un'elevata resistenza all'usura e robustezza del tagliente, è adatta a un'ampia gamma di applicazioni di tornitura su acciai, così come su molti acciai inossidabili e ghise. Ti(C,N) + Al ₂ O ₃ + ...		Foratura
TP3501		TP3501 è indicata per operazioni di barenatura in cui i requisiti primari sono tenacità e affidabilità nella lavorazione di acciai e acciai inossidabili. Ti(C,N) + Al ₂ O ₃ DURATOMIC®		
TP40		TP40 è la qualità base per la tornitura nella gamma P40. Qualità molto tenace per operazioni impegnative su pezzi fusi e forgiati in acciaio e su tutti i tipi di acciaio inossidabile. TiC/Ti(C,N) + TiN	Alesatura	
TK0501		Qualità rivestita con tecnologia Duratomic®. Una qualità ottimizzata estremamente resistente all'usura per la lavorazione di ghisa grigia e ghise sferoidali meno difficoltose. Ti(C,N) + Al ₂ O ₃ + Rilevamento del tagliente usurato (Chrome)		
TK1501		Qualità rivestita con tecnologia Duratomic®. Una qualità altamente resistente all'usura per le ghise in generale così come per gli acciai. Questa qualità è particolarmente adatta per la lavorazione di ghise sferoidali (nodulari) anche di difficile lavorabilità e con tagli interrotti. Ti(C,N) + Al ₂ O ₃ + Rilevamento del tagliente usurato (Chrome)		
TM2501		Qualità Duratomic®. Qualità ad ampio spettro applicativo, ottimo rapporto tra resistenza all'usura e tenacità. Prima scelta per tornitura di acciai inossidabili austenitici. Complementare nella tornitura di acciaio con taglio fortemente interrotto. Ti(C,N) + Al ₂ O ₃ + Rilevamento del tagliente usurato (Chrome)	Barenatura	
TH1500		Qualità rivestita con tecnologia DURATOMIC®. Una qualità super micrograna estremamente dura, per la lavorazione di acciai costituiti da parti temprati e non; fornisce un'alternativa per la finitura della ghisa. Ti(C,N) + Al ₂ O ₃		
25		Qualità universale. La qualità è indicata per un'ampia gamma di applicazioni di barenatura su acciaio, acciaio inossidabile e ghisa. Buona combinazione di resistenza all'usura e tenacità. Ti (C, N) + Al ₂ O ₃ .	Allegato	



Le qualità rivestite PVD sono consigliate per la barenatura

<p>Introduzione</p> <p>TS2000</p>		<p>Micrograna resistente all'usura indicata principalmente per le operazioni di finitura su superleghe e leghe di titanio. Inoltre, offre buone prestazioni nelle operazioni di finitura su acciaio inossidabile. (Ti,Al)N + TiN</p>
<p>CP500 & 26G6</p>		<p>Una micrograna molto tenace per la finitura e la sgrossatura media di acciaio inossidabile. È in grado di gestire molto bene le operazioni di taglio interrotti. CP500 è anche un'alternativa per le leghe di alluminio. (Ti,Al)N + TiN</p>
<p>Foratura</p> <p>TH1000</p>		<p>Qualità supermicrograna molto dura, progettata per componenti in acciaio costituite da parti temprate e non così come per materiali da lavorare generici come le superleghe; grazie alla notevole tenacità del tagliente, offre anche prestazioni elevate in tagli interrotti e asportazione su superfici dure.</p>



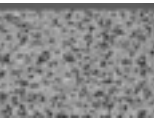

Le qualità non rivestite sono consigliate per la barenatura

<p>KX & 03G3</p>		<p>Micrograna indicata per la lavorazione di alluminio e altri materiali non ferrosi.</p>
<p>Alesatura</p> <p>HX</p>		<p>Qualità universale non rivestita per la lavorazione di ghisa e acciai temprati, utile anche per materiali non ferrosi.</p>

Cermet è consigliato per la barenatura

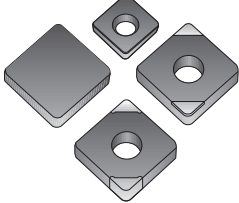
<p>Barenatura</p> <p>TP1020</p>		<p>Cermet con resistenza all'usura molto elevata per i più elevati requisiti di finitura superficiale con usura prevedibile e controllo del truciolo su acciaio e acciaio inossidabile.</p>
<p>TP1030</p>		<p>Cermet rivestito PVD con resistenza all'usura molto elevata per i più rigorosi requisiti di finitura superficiale e produttività con usura prevedibile su acciaio e acciaio inossidabile. Rivestimento nanolaminato Ti-Al-Si-N.</p>
<p>51G1</p>		<p>Cermet con resistenza all'usura molto elevata. Per operazioni di finitura su acciai, in presenza di requisiti rigorosi per la finitura della superficie.</p>

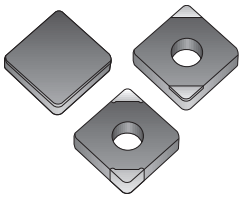
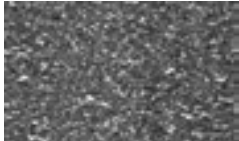
Le qualità r CBN e PCD sono consigliate per la barenatura

CBN010		<p>Formato: Integrale, riporto completo brasato e placchette brasate (monolaterali e bilaterali). Composizione: Qualità contenente il 50% di CBN con dimensione media della grana di 2 µm e legante ceramico TiC. Rivestimento: Nessun rivestimento.</p>	Introduzione
CBN10 & 81B1		<p>CBN, qualità nitruro di boro cubico, per finitura con taglio da continuo a moderatamente interrotto. Per la barenatura di finitura di acciaio temprato e superleghe.</p>	
CBN060K		<p>Integrale, inserti brasati (monolaterali e bilaterali) o strato sinterizzato. Prima scelta per taglio da continuo a moderatamente interrotto su acciaio temprato ($a_p < 0,5$ mm). Nuovo rivestimento (Ti, Si, Al)N PVD sviluppato per lavorazioni ad alta velocità. Nuovo esclusivo legante in superlega.</p>	Foratura
CBN200		<p>Formato: Riporto completo e placchette brasate (monolaterali). Composizione: Qualità contenente 85% di cBN con dimensione media della grana di 2 µm e legante ceramico Co-W-Al. Rivestimento: Nessun rivestimento.</p>	
PCD20 & 91J3		<p>PCD, diamante policristallino, per la barenatura di alluminio e leghe di alluminio, rame, ottone, bronzo e materiali sintetici.</p>	Alesatura
			Allegato

Inseri consigliati per barenatura di sgrossatura, con parametri di taglio

Codice di ordinazione	Non rivestite Fianco rettificato e formatrucciolo di pressatura			Rivestite Formatrucciolo di pressatura					Rivestite Fianco rettificato e formatrucciolo di pressatura, taglio sinistro	Profondità di taglio a _p mm (inch)	Avanzamento al dente f mm (inch)
	KX	HX	03D3	TP2501	TP3501	TP40	25C4	TK1501	CP500		
CPGT050204			02434654							2 (0.079)	0,08-0,2 (0.0031-0.0079)
CCMT060204-F1				02960857	03095430	00008505		03062942	00096854	2 (0.079)	0,1-0,22 (0.0039-0.0087)
CCMT060204-F2		74011732				74018652				2 (0.079)	0,1-0,22 (0.0039-0.0087)
CCGT060204L-UX									02497631	2 (0.079)	0,1-0,22 (0.0039-0.0087)
CCGT060204F-AL	00015710									2 (0.079)	0,1-0,22 (0.0039-0.0087)
CCMT060204-M3				02960858	03095431			03062944		2 (0.079)	0,1-0,22 (0.0039-0.0087)
CCMT09T308-F1				02960861	03095443	00008518		03063857	00096858	2,5 (0.098)	0,1-0,3 (0.0039-0.0118)
CCMT09T308-MF2				02956309	03095446				02754822	2,5 (0.098)	0,1-0,3 (0.0039-0.0118)
CCGT09T304L-UX									02497640	2,5 (0.098)	0,1-0,3 (0.0039-0.0118)
CCGT09T308F-AL	00015754									2,5 (0.098)	0,1-0,3 (0.0039-0.0118)
CCMT120408-F1				02960854	03095449			03062626		4 (0.157)	0,15-0,4 (0.0059-0.0157)
CCMT120408-MF2				02956311	03095452					4 (0.157)	0,15-0,4 (0.0059-0.0157)
CCGT120408L-UX									02610062	4 (0.157)	0,15-0,4 (0.0059-0.0157)
CCGT120408F-AL	00015790									5 (0.197)	0,15-0,4 (0.0059-0.0157)
SCMT060204-M3				02960423	03096621					2,5 (0.098)	0,1-0,22 (0.0039-0.0087)
SCMT09T308-F1				02960396	03096625			03062629	00099708	2,5 (0.098)	0,1-0,3 (0.0039-0.0118)
SCMT09T308-MF2				02956318	03096627				02755042	2,5 (0.098)	0,1-0,3 (0.0039-0.0118)
SCMT120408-F1				02960397	03096630				00099804	4 (0.157)	0,15-0,4 (0.0059-0.0055)
SCMT120408-M3				02960429	03096631			03063990		4 (0.157)	0,15-0,4 (0.0059-0.0055)
TCMT16T308-F1				02960408	03096643				00091357	5 (0.197)	0,15-0,4 (0.0059-0.0055)
TCMT16T308-MF2				02956323	03096645				02755046	5 (0.197)	0,15-0,4 (0.0059-0.0055)
TCGT16T308F-AL	00015875									4 (0.157)	0,15-0,4 (0.0059-0.0055)
SCMT150512-F2						74007348				7 (0.276)	0,2-0,5 (0.0079-0.0197)

Per le velocità di taglio consigliate, vedere le pagine 686-689

Inseri CN., consigliati per barenatura di sgrossatura (bilaterali)

Codice di ordinazione	Rivestite Formatrucciolo di pressatura				Profondità di taglio a _p mm (inch)	Avanzamento al dente f mm (inch)
	TP3500	TP40	TM2501	TP25		
CNMG120408-M3			03275990	03275989	4,5 (0.177)	0,25-0,35 (0.00984-0.01378)
CNMG120408-MF3		74030598	03275999	03275998	4,5 (0.177)	0,25-0,35 (0.00984-0.01378)
CNMG120408-MF4			03273904		4,5 (0.177)	0,25-0,35 (0.00984-0.01378)
CNMG120408-MF1			03275995		4,5 (0.177)	0,25-0,35 (0.00984-0.01378)
CNMG120408-MR7		74017309	03276001		4,5 (0.177)	0,25-0,35 (0.00984-0.01378)

Per le velocità di taglio consigliate, vedere le pagine 686-689

Introduzione

Foratura

Alesatura

Barenatura

Allegato

Inseri consigliati per barenatura di finitura, con parametri di taglio

Codice di ordinazione	Rivestite							Cermet			Profondità di taglio a _p mm (inch)	Avanzamento al dente f mm (inch)
	TP1501	TS2000	TK1501	CP500	26G6	TH1000	TH1500	51G1	TP1020	TP1030		
CCGT060200								00083915			0,01-0,3 (0.000394-0.01181)	0,03-0,15 (0.0011811-0.0059055)
CCGT0602005-F1				02430287							0,01-0,3 (0.000394-0.01181)	0,03-0,15 (0.0011811-0.0059055)
CCGT060201-F1				02430307							0,01-0,3 (0.000394-0.01181)	0,03-0,15 (0.0011811-0.0059055)
CCGT060202					00039546			00096634			0,01-0,3 (0.000394-0.01181)	0,03-0,15 (0.0011811-0.0059055)
CCGT060204					00081826			00048334			0,01-0,3 (0.000394-0.01181)	0,03-0,15 (0.0011811-0.0059055)
CCGT060204L-UX				02497631							2 (0.079)	0,1-0,22 (0.0039-0.0087)
CCMT060202-F1	02960383	02614299		00096853				02754786	02754435		0,01-0,3 (0.000394-0.01181)	0,03-0,15 (0.0011811-0.0059055)
CCMT060204-F1	02960856	02615873	03062942	00096854		02825858		02754791	02754792		2 (0.079)	0,1-0,22 (0.0039-0.0087)
CCMW060202F-L1											0,01-0,3 (0.000394-0.01181)	0,03-0,15 (0.0011811-0.0059055)
CCMW060204F-L1											0,01-0,3 (0.000394-0.01181)	0,03-0,15 (0.0011811-0.0059055)
CCGW060202S-01020-LF											0,01-0,3 (0.000394-0.01181)	0,03-0,15 (0.0011811-0.0059055)
CCGW060204S-01020-LF											0,01-0,3 (0.000394-0.01181)	0,03-0,15 (0.0011811-0.0059055)
CCGW060204E-L1-B											0,01-0,3 (0.000394-0.01181)	0,03-0,15 (0.0011811-0.0059055)
CCGT09T301-F1				02430311							0,01-0,3 (0.000394-0.01181)	0,03-0,15 (0.0011811-0.0059055)
CCGT09T302					00048337			00048339			0,01-0,3 (0.000394-0.01181)	0,03-0,15 (0.0011811-0.0059055)
CCGT09T304					00077338			00048344			0,01-0,3 (0.000394-0.01181)	0,03-0,15 (0.0011811-0.0059055)
CCGT09T304L-UX				02497640							2,5 (0.098)	0,1-0,3 (0.0039-0.0118)
CCMT09T302-F1	02960837			00096856				02754805	02754806		0,01-0,3 (0.000394-0.01181)	0,03-0,15 (0.0011811-0.0059055)
CCMT09T304-F1	02960844	02615874	03063856	00096857		02731806		02754811	02754812		0,01-0,3 (0.000394-0.01181)	0,03-0,15 (0.0011811-0.0059055)
CCMT09T308-F1	02960853	02615876	03063857	00096858		02731807			02754821		2,5 (0.098)	0,1-0,3 (0.0039-0.0118)
CCMW09T304F-L1											0,01-0,3 (0.000394-0.01181)	0,03-0,15 (0.0011811-0.0059055)
CCMW09T308F-L1											0,01-0,3 (0.000394-0.01181)	0,03-0,15 (0.0011811-0.0059055)
CCGW09T304E-L1-B											0,01-0,3 (0.000394-0.01181)	0,03-0,15 (0.0011811-0.0059055)
CCGW09T308E-L1-B											0,01-0,3 (0.000394-0.01181)	0,03-0,15 (0.0011811-0.0059055)
CCGW09T304S-01020-LF											0,01-0,3 (0.000394-0.01181)	0,03-0,15 (0.0011811-0.0059055)
CCGW09T308S-01020-LF											0,01-0,3 (0.000394-0.01181)	0,03-0,15 (0.0011811-0.0059055)
TCGT110204								00000721			0,01-0,3 (0.000394-0.01181)	0,03-0,15 (0.0011811-0.0059055)
TCGT110201-F1				02430376							0,01-0,3 (0.000394-0.01181)	0,03-0,15 (0.0011811-0.0059055)
TCMT110202-F1				02430419							0,01-0,3 (0.000394-0.01181)	0,03-0,15 (0.0011811-0.0059055)
TCMT110204-F1	02960401			02430421							0,01-0,3 (0.000394-0.01181)	0,03-0,15 (0.0011811-0.0059055)
TCMT110208-F1	02960403			00098986							0,01-0,3 (0.000394-0.01181)	0,03-0,15 (0.0011811-0.0059055)
TCGW110204E-L1-C											0,01-0,3 (0.000394-0.01181)	0,03-0,15 (0.0011811-0.0059055)
TCGW110208E-L1-C											0,01-0,3 (0.000394-0.01181)	0,03-0,15 (0.0011811-0.0059055)
TCGW110204S-01020-LF											0,01-0,3 (0.000394-0.01181)	0,03-0,15 (0.0011811-0.0059055)
TCGW110208S-01020-LF											0,01-0,3 (0.000394-0.01181)	0,03-0,15 (0.0011811-0.0059055)
TCMW110204F-L1											0,01-0,3 (0.000394-0.01181)	0,03-0,15 (0.0011811-0.0059055)
WBG030100								00083089			0,01-0,3 (0.000394-0.01181)	0,03-0,15 (0.0011811-0.0059055)
WBG030102								00091845			0,01-0,3 (0.000394-0.01181)	0,03-0,15 (0.0011811-0.0059055)
WBG030102L				02416632							0,01-0,3 (0.000394-0.01181)	0,03-0,15 (0.0011811-0.0059055)
WBG030102											0,01-0,3 (0.000394-0.01181)	0,03-0,15 (0.0011811-0.0059055)

La tabella continua alla pagina successiva.

Per le velocità di taglio consigliate, vedere le pagine 686-689

Inserti consigliati per barenatura di finitura, con parametri di taglio

Codice di ordinazione	CBN				PCD		Profondità di taglio a _p mm (inch)	Avanzamento al dente f mm (inch)
	CBN010	CBN060K	CBN200	81B1	PCD20	91J3		
CCGT060200							0,01-0,3 (0.000394-0.01181)	0,03-0,15 (0.0011811-0.0059055)
CCGT0602005-F1							0,01-0,3 (0.000394-0.01181)	0,03-0,15 (0.0011811-0.0059055)
CCGT060201-F1							0,01-0,3 (0.000394-0.01181)	0,03-0,15 (0.0011811-0.0059055)
CCGT060202							0,01-0,3 (0.000394-0.01181)	0,03-0,15 (0.0011811-0.0059055)
CCGT060204							0,01-0,3 (0.000394-0.01181)	0,03-0,15 (0.0011811-0.0059055)
CCGT060204L-UX							2 (0.079)	0,1-0,22 (0.0039-0.0087)
CCMT060202-F1							0,01-0,3 (0.000394-0.01181)	0,03-0,15 (0.0011811-0.0059055)
CCMT060204-F1							2 (0.079)	0,1-0,22 (0.0039-0.0087)
CCMW060202F-L1					00089760		0,01-0,3 (0.000394-0.01181)	0,03-0,15 (0.0011811-0.0059055)
CCMW060204F-L1					0005684		0,01-0,3 (0.000394-0.01181)	0,03-0,15 (0.0011811-0.0059055)
CCGW060202S-01020-LF			02464698				0,01-0,3 (0.000394-0.01181)	0,03-0,15 (0.0011811-0.0059055)
CCGW060204S-01020-LF	02916281		02464699				0,01-0,3 (0.000394-0.01181)	0,03-0,15 (0.0011811-0.0059055)
CCGW060204E-L1-B	02843086	02776337	02649599				0,01-0,3 (0.000394-0.01181)	0,03-0,15 (0.0011811-0.0059055)
CCGT09T301-F1							0,01-0,3 (0.000394-0.01181)	0,03-0,15 (0.0011811-0.0059055)
CCGT09T302							0,01-0,3 (0.000394-0.01181)	0,03-0,15 (0.0011811-0.0059055)
CCGT09T304							0,01-0,3 (0.000394-0.01181)	0,03-0,15 (0.0011811-0.0059055)
CCGT09T304L-UX							2,5 (0.098)	0,1-0,3 (0.0039-0.0118)
CCMT09T302-F1							0,01-0,3 (0.000394-0.01181)	0,03-0,15 (0.0011811-0.0059055)
CCMT09T304-F1							0,01-0,3 (0.000394-0.01181)	0,03-0,15 (0.0011811-0.0059055)
CCMT09T308-F1							2,5 (0.098)	0,1-0,3 (0.0039-0.0118)
CCMW09T304F-L1					0005686		0,01-0,3 (0.000394-0.01181)	0,03-0,15 (0.0011811-0.0059055)
CCMW09T308F-L1					00095357		0,01-0,3 (0.000394-0.01181)	0,03-0,15 (0.0011811-0.0059055)
CCGW09T304E-L1-B	02843126	02776338	02649607				0,01-0,3 (0.000394-0.01181)	0,03-0,15 (0.0011811-0.0059055)
CCGW09T308E-L1-B	02937148		02649608				0,01-0,3 (0.000394-0.01181)	0,03-0,15 (0.0011811-0.0059055)
CCGW09T304S-01020-LF	02916282		02464702				0,01-0,3 (0.000394-0.01181)	0,03-0,15 (0.0011811-0.0059055)
CCGW09T308S-01020-LF			02464703				0,01-0,3 (0.000394-0.01181)	0,03-0,15 (0.0011811-0.0059055)
TCGT110204							0,01-0,3 (0.000394-0.01181)	0,03-0,15 (0.0011811-0.0059055)
TCGT110201-F1							0,01-0,3 (0.000394-0.01181)	0,03-0,15 (0.0011811-0.0059055)
TCMT110202-F1							0,01-0,3 (0.000394-0.01181)	0,03-0,15 (0.0011811-0.0059055)
TCMT110204-F1							0,01-0,3 (0.000394-0.01181)	0,03-0,15 (0.0011811-0.0059055)
TCMT110208-F1							0,01-0,3 (0.000394-0.01181)	0,03-0,15 (0.0011811-0.0059055)
TCGW110204E-L1-C	02848657	02776346					0,01-0,3 (0.000394-0.01181)	0,03-0,15 (0.0011811-0.0059055)
TCGW110208E-L1-C	02848792						0,01-0,3 (0.000394-0.01181)	0,03-0,15 (0.0011811-0.0059055)
TCGW110204S-01020-LF			02464742				0,01-0,3 (0.000394-0.01181)	0,03-0,15 (0.0011811-0.0059055)
TCGW110208S-01020-LF			02464744				0,01-0,3 (0.000394-0.01181)	0,03-0,15 (0.0011811-0.0059055)
TCMW110204F-L1					0005689		0,01-0,3 (0.000394-0.01181)	0,03-0,15 (0.0011811-0.0059055)
WBG030100							0,01-0,3 (0.000394-0.01181)	0,03-0,15 (0.0011811-0.0059055)
WBG030102							0,01-0,3 (0.000394-0.01181)	0,03-0,15 (0.0011811-0.0059055)
WBG030102L							0,01-0,3 (0.000394-0.01181)	0,03-0,15 (0.0011811-0.0059055)
WBGW030102				00096761		00096763	0,01-0,3 (0.000394-0.01181)	0,03-0,15 (0.0011811-0.0059055)

Per le velocità di taglio consigliate, vedere le pagine 686-689

Velocità di taglio consigliate per la barenatura (in relazione al materiale del pezzo da lavorare e alla qualità dell'inserto) – misure metriche

SMG	v _c (m/min)										
	KX & HX	03	TP40	TP1501	TP2501	TP3501	TK0501	TK1501	TH1000	TH1500	CP500
P1			60-180	60-350	60-250	60-230					80-200
P2			60-180	60-350	60-250	60-230					80-200
P3			60-180	60-350	60-250	60-230					80-200
P4			60-180	60-350	60-250	60-230					80-200
P5			60-150	60-300	60-250	60-230					80-200
P6			60-140	60-300	60-230	60-200					80-180
P7			60-140	60-300	60-230	60-200					80-160
P8			60-120	60-250	60-230	60-200					80-130
P11			60-120	60-300	60-250	60-200					80-180
M1			60-130	100-200	60-200	60-200					60-160
M2			60-130	100-200	60-200	60-200					60-160
M3			60-120	100-180	60-200	60-200					60-150
M4			60-110	100-180	60-190	60-190					60-150
M5			60-110	100-180	60-180	60-180					60-150
K1			60-140	100-250		60-180	60-230	60-230			60-160
K2			60-140	100-250		60-180	60-230	60-230			60-160
K3			60-140	100-250		60-180	60-230	60-230			60-160
K4			60-140	100-250		60-180	60-200	60-200			60-160
K5			60-140	100-250		60-180	60-200	60-200			60-160
K6			60-130	100-250		60-180	60-200	60-200			60-160
K7			60-130	100-250		60-180	60-200	60-200			60-160
N1	150-800	150-800									150-800
N2	150-800	150-800									150-800
N3	150-500	150-500									150-500
N11	150-400	150-400									150-400
S1	20-50	20-50									20-50
S2	20-50	20-50									20-50
S3	20-50	20-50									20-50
S11	20-50	20-50									20-50
S12	20-50	20-50									20-50
S13	20-50	20-50									20-50
H3									50-150	50-150	
H5									50-140	50-140	
H7									50-150	50-150	
H8									30-130	30-130	
H11									30-120	30-120	
H12									30-120	30-120	
H21											
H31											

SMG = gruppo materiale Seco V_c = m/min Tutti i parametri di taglio sono valori di partenza

Velocità di taglio consigliate per la barenatura (in relazione al materiale del pezzo da lavorare e alla qualità dell'inserto) – Pollici

SMG	V_c (sf/min)										
	KX & HX	03	TP40	TP1501	TP2501	TP3501	TK0501	TK1501	TH1000	TH1500	CP500
P1			197-591	197-1148	197-820	197-755					262-656
P2			197-591	197-1148	197-820	197-755					262-656
P3			197-591	197-1148	197-820	197-755					262-656
P4			197-591	197-1148	197-820	197-755					262-656
P5			197-492	197-984	197-820	197-755					262-656
P6			197-459	197-984	197-755	197-656					262-591
P7			197-459	197-984	197-755	197-656					262-525
P8			197-394	197-820	197-755	197-656					262-427
P11			197-394	197-984	197-820	197-656					262-591
M1			197-427	328-656	197-656	197-656					197-525
M2			197-427	328-656	197-656	197-656					197-525
M3			197-394	328-591	197-656	197-656					197-492
M4			197-361	328-591	197-623	197-623					197-492
M5			197-361	328-591	197-591	197-591					197-492
K1			197-459	328-820		197-591	197-755	197-755			197-525
K2			197-459	328-820		197-591	197-755	197-755			197-525
K3			197-459	328-820		197-591	197-755	197-755			197-525
K4			197-459	328-820		197-591	197-656	197-656			197-525
K5			197-459	328-820		197-591	197-656	197-656			197-525
K6			197-427	328-820		197-591	197-656	197-656			197-525
K7			197-427	328-820		197-591	197-656	197-656			197-525
N1	492-2625	492-2625									492-2625
N2	492-2625	492-2625									492-2625
N3	492-1640	492-1640									492-1640
N11	492-1312	492-1312									492-1312
S1	66-164	66-164									66-164
S2	66-164	66-164									66-164
S3	66-164	66-164									66-164
S11	66-164	66-164									66-164
S12	66-164	66-164									66-164
S13	66-164	66-164									66-164
H3								164-492	164-492		
H5								164-459	164-459		
H7								164-492	164-492		
H8								98-427	98-427		
H11								98-394	98-394		
H12								98-394	98-394		
H21											
H31											

SMG = gruppo materiale Seco V_c = m/min Tutti i parametri di taglio sono valori di partenza

Introduzione

Foratura

Alesatura

Barenatura

Allegato

Velocità di taglio consigliate per la barenatura (in relazione al materiale del pezzo da lavorare e alla qualità dell'inserto) – misure metriche

SMG	v _c (m/min)												
	26	25	TS2000	TP1020	TP1030	51	CBN10/ CBN010	81	CBN200	82	PCD20	91	Axiabore
P1	80-200	60-180		100-350	100-350	100-350							80-250
P2	80-200	60-180		100-350	100-350	100-350							80-250
P3	80-200	60-180		100-350	100-350	100-350							80-250
P4	80-200	60-180		100-350	100-350	100-350							80-250
P5	80-200	60-180		100-350	100-350	100-350							70-230
P6	80-180	60-160		100-300	100-300	100-300							70-230
P7	80-160	60-160		100-250	100-250	100-250							70-230
P8	80-130	60-130		100-250	100-250	100-250							70-200
P11	80-180	60-150		100-300	100-300	100-300							70-200
M1	60-160	60-140	60-200	80-200	80-200	80-200							60-200
M2	60-160	60-140	60-200	80-200	80-200	80-200							60-200
M3	60-150	60-130	60-200	80-200	80-200	80-200							60-180
M4	60-150	60-120	60-180	80-180	80-180	80-180							60-170
M5	60-150	60-120	60-180	80-180	80-180	80-180							60-170
K1	60-160	60-160		100-250	100-250	100-250			300-1000	300-1000			60-150
K2	60-160	60-160		100-250	100-250	100-250			300-1000	300-1000			60-150
K3	60-160	60-160		100-250	100-250	100-250			300-1000	300-1000			60-150
K4	60-160	60-160		100-250	100-250	100-250			300-1000	300-1000			60-130
K5	60-160	60-160		100-250	100-250	100-250							50-100
K6	60-160	60-160		100-180	100-180	100-180							50-100
K7	60-160	60-160		100-180	100-180	100-180							50-100
N1	150-800										300-1500	300-1500	200-800
N2	150-800										300-1500	300-1500	200-800
N3	150-500										200-800	200-800	200-800
N11	150-400										180-800	180-800	200-800
S1	20-50		20-80										20-60
S2	20-50		20-80										20-60
S3	20-50		20-80										60-50
S11	20-50		20-80										20-50
S12	20-50		20-80										20-50
S13	20-50		20-80										20-50
H3							80-180	80-180					
H5							80-200	80-200					
H7							80-150	80-150					
H8							80-150	80-150					
H11													
H12													
H21													
H31													

SMG = gruppo materiale Seco V_c = m/min Tutti i parametri di taglio sono valori di partenza

Velocità di taglio consigliate per la barenatura (in relazione al materiale del pezzo da lavorare e alla qualità dell'inserto) – Pollici

SMG	v _c (sf/min)												
	26	25	TS2000	TP1020	TP1030	51	CBN10/ CBN010	81	CBN200	82	PCD20	91	Axiabore
P1	262-656	197-591		328-1148	328-1148	328-1148							262-820
P2	262-656	197-591		328-1148	328-1148	328-1148							262-820
P3	262-656	197-591		328-1148	328-1148	328-1148							262-820
P4	262-656	197-591		328-1148	328-1148	328-1148							262-820
P5	262-656	197-591		328-1148	328-1148	328-1148							230-755
P6	262-591	197-525		328-984	328-984	328-984							230-755
P7	262-525	197-525		328-820	328-820	328-820							230-755
P8	262-427	197-427		328-820	328-820	328-820							230-656
P11	262-591	197-492		328-984	328-984	328-984							230-656
M1	197-525	197-459	197-656	262-656	262-656	262-656							197-656
M2	197-525	197-459	197-656	262-656	262-656	262-656							197-656
M3	197-492	197-427	197-656	262-656	262-656	262-656							197-591
M4	197-492	197-394	197-591	262-591	262-591	262-591							197-558
M5	197-492	197-394	197-591	262-591	262-591	262-591							197-558
K1	197-525	197-525		328-820	328-820	328-820		984-3281	984-3281				197-492
K2	197-525	197-525		328-820	328-820	328-820		984-3281	984-3281				197-492
K3	197-525	197-525		328-820	328-820	328-820		984-3281	984-3281				197-492
K4	197-525	197-525		328-820	328-820	328-820		984-3281	984-3281				197-427
K5	197-525	197-525		328-820	328-820	328-820							164-328
K6	197-525	197-525		328-591	328-591	328-591							164-328
K7	197-525	197-525		328-591	328-591	328-591							164-328
N1	492-2625									984-4921	984-4921		656-2625
N2	492-2625									984-4921	984-4921		656-2625
N3	492-1640									656-2625	656-2625		656-2625
N11	492-1312									591-2625	591-2625		656-2625
S1	66-164		66-262										66-197
S2	66-164		66-262										66-197
S3	66-164		66-262										197-164
S11	66-164		66-262										66-164
S12	66-164		66-262										66-164
S13	66-164		66-262										66-164
H3							262-591	262-591					
H5							262-656	262-656					
H7							262-492	262-492					
H8							262-492	262-492					
H11													
H12													
H21													
H31													

SMG = gruppo materiale Seco V_c = m/min Tutti i parametri di taglio sono valori di partenza

Introduzione

Foratura

Alesatura

Barenatura

Allegato

Chiavi e viti di bloccaggio inserti per portainseriti, utensili e cartucce di barenatura

		Accessori			Parti di ricambio	
		Cacciavite Torx per viti di bloccaggio inserto *			Vite di bloccaggio inserto	
Per portainseriti di barenatura di sgrossatura	Per dimensione inserto	Codice di ordinazione	Torx Plus	Codice di ordinazione	Torx Plus	
	CP...0502	T07P-3	07	C02245-T07P	07	
	CC...0602	T07P-3	07	C02504-T07P	07	
	CC...09T3	T15P-3	15	C04008-T15P	15	
	CC...1204	T15P-3	15	C05012-T15P	15	
	CC...1605	T15P-3	15	C05012-T15P	15	
	SC...0502	T07P-3	07	C02245-T07P	07	
	SC...0602	T07P-3	07	C02504-T07P	07	
	SC...09T3	T15P-3	15	C04008-T15P	15	
	SC...1204	T15P-3	15	C05012-T15P	15	
SC...1505	T15P-3	15	C05012-T15P	15		

* Un cacciavite Torx viene fornito con ciascuna testa per barenatura di sgrossatura.

		Accessori			Parti di ricambio	
		Cacciavite Torx per viti di bloccaggio inserto *			Vite di bloccaggio inserto	
Per tipo di utensile Axiabore™	Per dimensione inserto	Codice di ordinazione	Torx Plus	Codice di ordinazione	Torx Plus	
	WB...0301...	T06P-3	06	C02035-T06P	06	
	CC...0602...	T07P-3	07	C02504-T07P	07	
	-	T15P-3	15	C04008-T15P	15	

Ricambi per portainseriti

		Parti di ricambio			
		Chiave per vite inserto		Vite di bloccaggio inserto	
Per portainseriti per barenatura di finitura, portainseriti di smussatura e portainseriti per barenatura in tirata	Per dimensione inserto	Codice di ordinazione	Torx Plus	Codice di ordinazione	Torx Plus
	WB...0301...	T06P-2	06	C02035-T06P	06
	CC...0602...	T07P-3	07	C02504-T07P	07
	CC...09T3...	T15P-3	15	C04008-T15P	15
	TC...1102...	T07P-3	07	C02504-T07P	07

		Accessori			Parti di ricambio	
		Cacciavite Torx per viti di bloccaggio inserto *			Vite di bloccaggio inserto	
Per cartucce	Per dimensione inserto	Codice di ordinazione	Torx Plus	Codice di ordinazione	Torx Plus	
	CC...16...	T15P-2	15	C05012-T15P	15	
	SC...15...	T15P-2	15	C05012-T15P	15	
	TC...16...	T15P-2	15	C03509-T15P	15	
	TC...22...	T15P-2	15	C05012-T15P	15	

Attacchi adatti per teste di barenatura

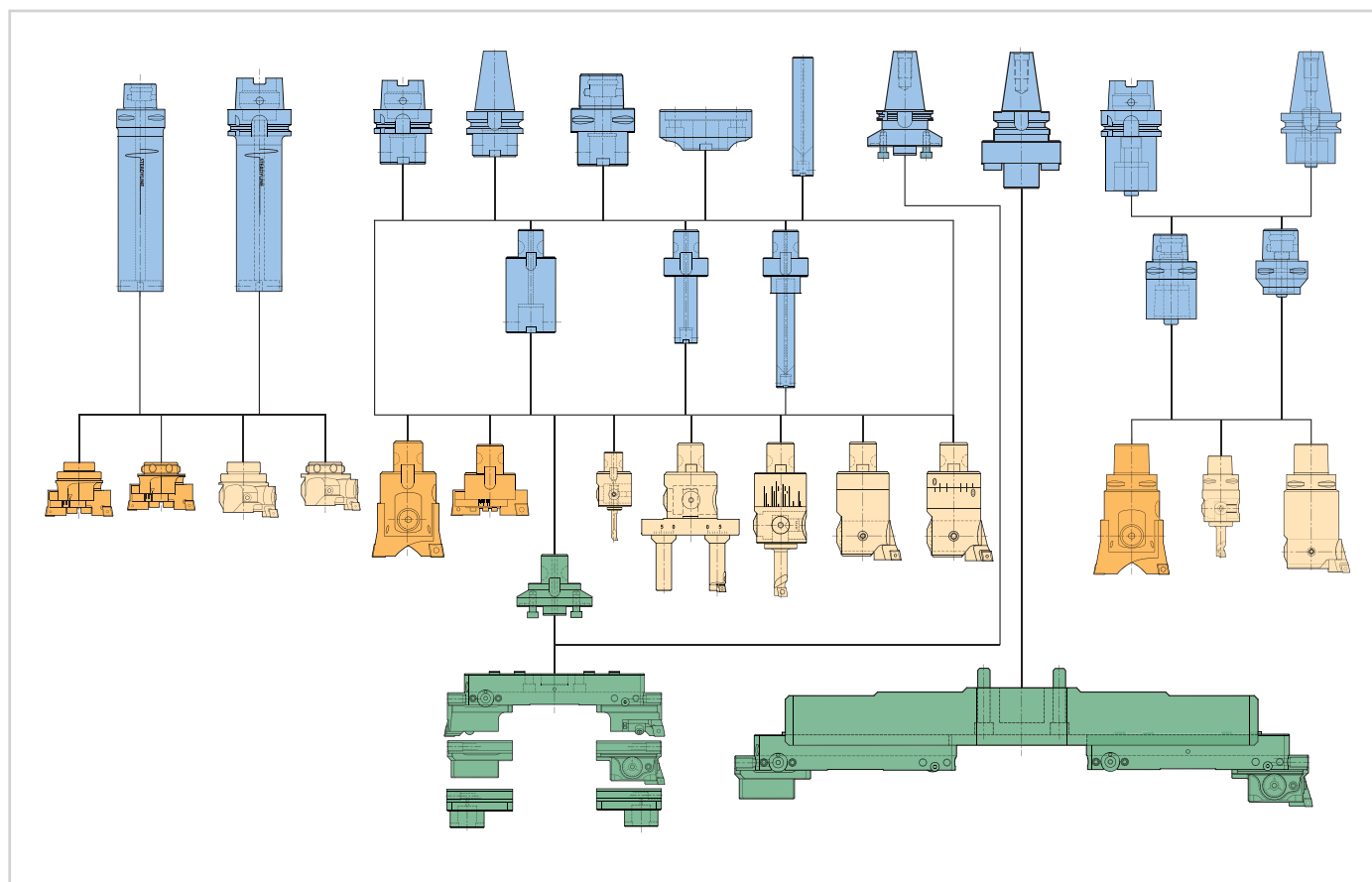

Le testine per barenatura hanno connessione lato macchina Graflex®, Seco-Capto™, GL o BA

Le testine per barenatura possono essere utilizzate su qualsiasi tipo di macchina, utilizzando l'adeguato adattatore Graflex®, Seco-Capto™ o l'adeguata barra Steadyline® di barenatura/tornitura con smorzamento delle vibrazioni.

Smorzamento delle vibrazioni Steadyline® per operazioni di barenatura

Le testine per barenatura con connessione lato macchina GL o BA sono progettate per essere montate su barre di barenatura/tornitura Steadyline® con connessione lato macchina HSK-T/A e Seco-Capto™. Questo consente di effettuare operazioni di barenatura di sgrossatura e di finitura con profondità 6xD, 8xD e 10xD in condizioni molto stabili.

Barre di barenatura modulari Graflex® e Seco-Capto™

Assemblando diverse parti intermedie Graflex® si possono raggiungere tutte le profondità di barenatura fino a 6xD; sono anche disponibili prolunghe extra-lunghe in metallo duro. Una maggiore rigidità di assemblaggio si ottiene selezionando l'attacco base più lungo o di maggior diametro possibile, quindi completando il sistema con elementi intermedi.

Le connessioni Graflex® e Seco-Capto™ garantiscono un orientamento unico delle testine per barenatura, in conformità agli standard ISO. I moduli Graflex® sono progettati per essere bloccati agendo su di una vite laterale, non è quindi necessario smontare tutto l'assemblato.

Per le testine per barenatura con connessione lato macchina GL per Steadyline®, selezionare la barra Steadyline® più corta dal catalogo Sistemi di Utensili. Queste barre sono disponibili con connessione lato macchina HSK-T/A e Seco-Capto™. È possibile impiegarle su altri tipi di mandrini macchina, usando gli adattatori Seco-Capto™ più corti.

Per testine per barenatura tradizionali (in acciaio), selezionare gli attacchi e le parti intermedie Graflex® e Seco-Capto™ tradizionali dal catalogo Sistemi di Utensili. Per ponti di barenatura, vedere adattatori ed attacchi Graflex® a pagina 671.

Nota! I ponti di barenatura Jumbo sono progettati per essere montati su attacchi per frese a manicotto oppure direttamente sul mandrino macchina.

Consigli di bloccaggio per connessione Graflex® classica tipo G. su testine per barenatura (usando un tenone con vite di fermo).

Per la barenatura, non è necessario serrare la vite di bloccaggio del tenone, in quanto la connessione ha effetto autobloccante.
Per la barenatura di sgrossatura pesante, raccomandiamo di applicare il "valore alto" della coppia di serraggio per le viti a sfera Graflex®.

Vedere anche i dettagli relativi alla procedura di assemblaggio della connessione Graflex® nel catalogo Sistemi di Utensili.

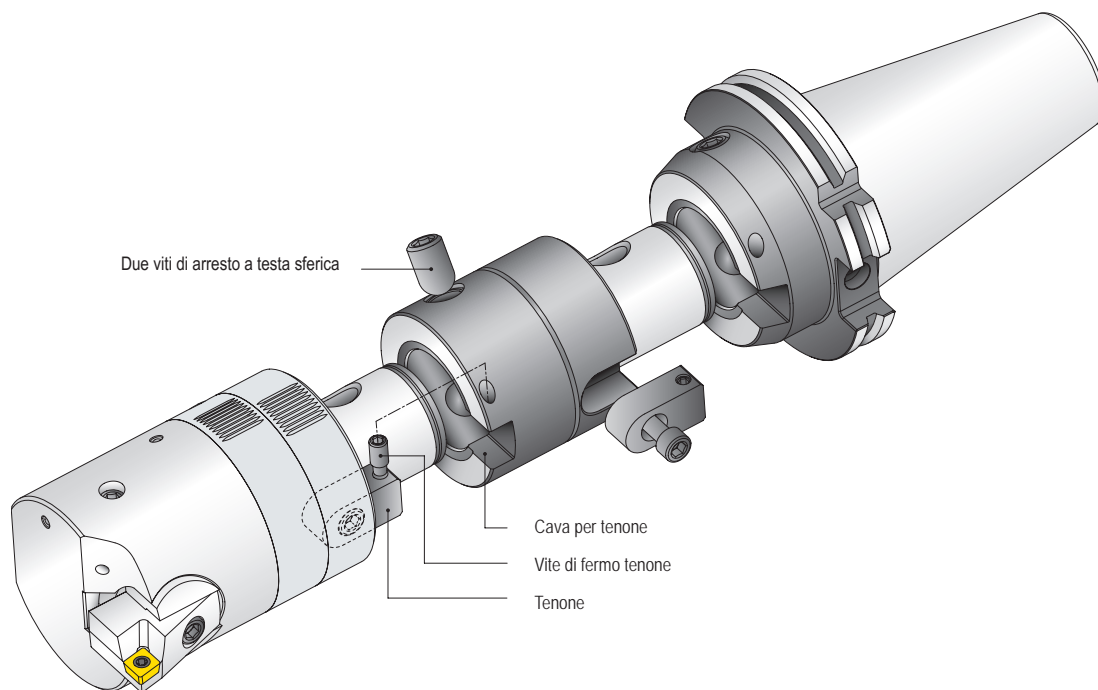

Consigli di bloccaggio per testine per barenatura con connessione Seco-Capto™ tipo C.: Nessun consiglio specifico. Per le testine per barenatura, si applicano le istruzioni generiche, vedere qui sotto.

Coppie di serraggio per connessioni Seco-Capto™ con bloccaggio con vite centrale (attacchi base, parti intermedie).

Dimensione Seco-Capto	Coppia di serraggio della vite centrale: (Nm)	Coppia di serraggio della vite centrale: (ft/lbs)
C3	40-50	30-37
C4	50-60	37-44
C5	90-100	66-74
C6	160-180	118-133
C8	160-180	118-133



Coppie di serraggio per connessioni Seco-Capto™ con bloccaggio ad espansione radiale, tramite una vite laterale con camma (montaggio in flangia.)

Dimensione Seco-Capto	Coppia di serraggio della camma (Nm)	Coppia di serraggio della camma (ft/lbs)
C3	35	26
C4	50	37
C5	70	52
C6	90	66
C8	130	96

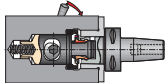

La connessione Seco-Capto™ ha la caratteristica di essere conica ed auto-bloccante. Quando si utilizza il sistema di bloccaggio a vite centrale, allentare la vite finché la testa della vite va a contatto con l'attacco, causando l'espulsione di ciò che è connesso frontalmente. Quando si utilizza il sistema di bloccaggio a vite laterale, forzare la vite in apertura per causare l'espulsione di ciò che è connesso frontalmente.

Tolleranza standard ISO per foro ed albero – Tolleranze albero

La posizione della tolleranza dell'albero è designata da lettere minuscole

La posizione della tolleranza del foro è designata da LETTERE MAIUSCOLE

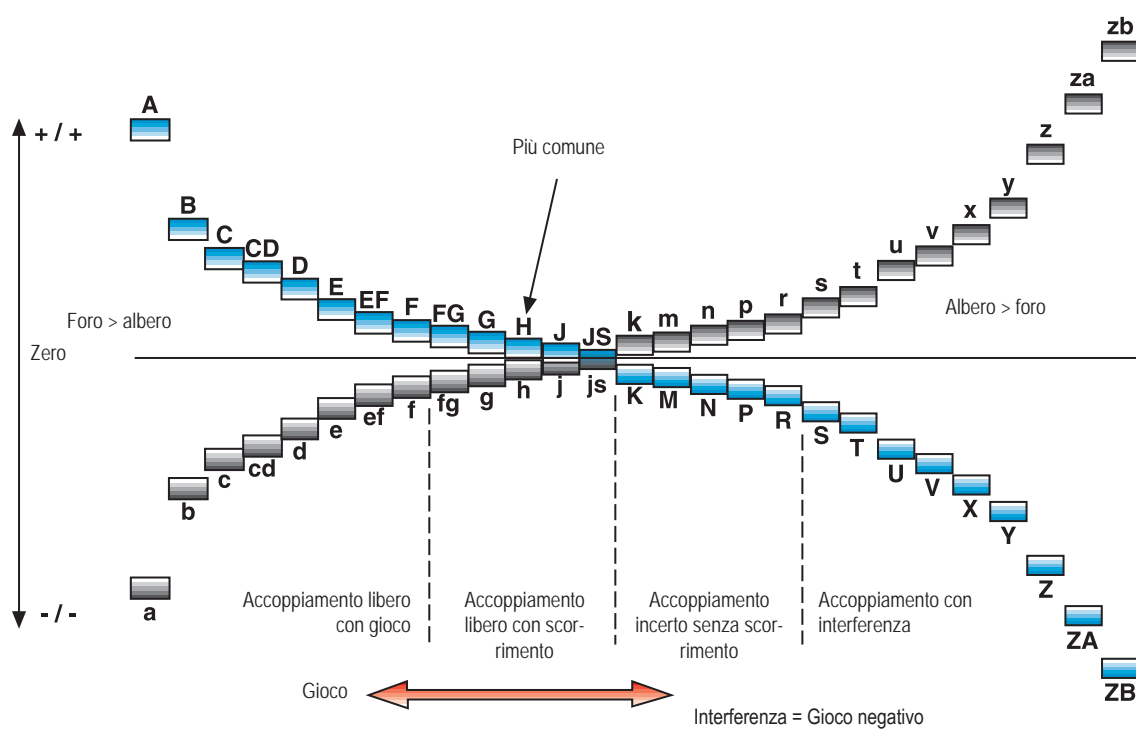
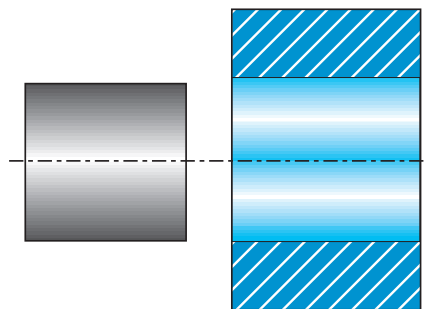

Introduzione

Foratura

Alesatura

Barenatura

Allegato

Tabella tolleranze ISO

Tolleranze ISO per i fori (µm)													
Foro Ø mm (inch)	D10	E9	F7	F8	G7	G9	H6	H7	H8	H9	H10	H11	H12
≤ 3 (0.118")	+60 +20	+39 +14	+16 +6	+20 +6	+12 +2	+27 +2	+6 0	+10 0	+14 0	+25 0	+40 0	+60 0	+100 0
3 ≥ 6 (0.236")	+78 +30	+50 +20	+22 +10	+28 +10	+16 +4	+34 +4	+8 0	+12 0	+18 0	+30 0	+48 0	+75 0	+120 0
6 ≥ 10 (0.394")	+98 +40	+61 +25	+28 +13	+35 +13	+20 +5	+41 +5	+9 0	+15 0	+22 0	+36 0	+58 0	+90 0	+150 0
10 ≥ 18 (0.708")	+120 +50	+75 +32	+34 +16	+43 +16	+24 +6	+49 +6	+11 0	+18 0	+27 0	+43 0	+70 0	+110 0	+180 0
18 ≥ 30 (1.181")	+149 +65	+92 +40	+41 +20	+53 +20	+28 +7	+59 +7	+13 0	+21 0	+33 0	+52 0	+84 0	+130 0	+210 0
30 ≥ 50 (1.969")	+180 +80	+112 +50	+50 +25	+64 +25	+34 +9	+71 +9	+16 0	+25 0	+39 0	+62 0	+100 0	+160 0	+250 0
50 ≥ 65 (2.559")	+220	+134	+60	+76	+40	-	+19	+30	+46	+74	+120	+190	+300
65 ≥ 80 (3.150")	+100	+60	+30	+30	+10	-	0	0	0	0	0	0	0
80 ≥ 100 (3.937")	+260	+159	+71	+90	+47	-	+22	+35	+54	+87	+140	+220	+350
100 ≥ 120 (4.724")	+120	+72	+36	+36	+12	-	0	0	0	0	0	0	0
120 ≥ 140 (5.512")													
140 ≥ 160 (6.299")	+305 +145	+185 +85	+83 +43	+106 +43	+54 +14	-	+25 0	+40 0	+63 0	+100 0	+160 0	+250 0	+400 0
160 ≥ 180 (7.087")													
180 ≥ 200 (7.874")													
200 ≥ 225 (8.858")	+355 +170	+215 +110	+96 +50	+122 +50	+61 +15	-	+29 0	+46 0	+72 0	+115 0	+185 0	+290 0	+460 0
225 ≥ 250 (9.843")													
250 ≥ 280 (11.0236")	+400 +190	+240 +110	+108 +56	+137 +56	+69 +17	-	+32 0	+52 0	+81 0	+130 0	210 0	+320 0	+520 0
280 ≥ 315 (12.402")													
315 ≥ 355 (13.976")	+440 +210	+265 +125	+119 +62	+151 +62	+75 +18	-	+36 0	+57 0	+89 0	+140 0	+230 0	+360 0	+570 0
355 ≥ 400 (15.748")													

Introduzione

Foratura

Alesatura





Barenatura

Allegato

Tabella tolleranze ISO

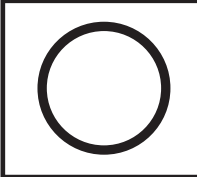
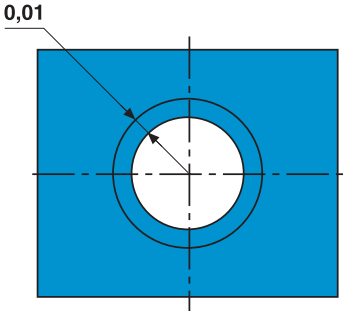
Tolleranze ISO per i fori (µm)													
Foro Ø mm (inch)	H13	JS7	JS9	K6	K7	M6	M7	N7	N9	P7	P9	R7	
≤ 3 (0.118")	+140 0	+/-5	+/-12,5	0 -6	0 -10	-2 -8	-2 -12	-4 -14	-4 -29	-6 -16	-6 -31	-10 -20	
3 ≥ 6 (0.236")	+180 0	+/-6	+/-15	+2 -6	+3 -9	-1 -9	0 -12	-4 -16	0 -30	-8 -20	-12 -42	-11 -23	
6 ≥ 10 (0.394")	+220 0	+/-7,5	+/-18	+2 -7	+5 -10	-3 -12	0 -15	-4 -19	0 -36	-9 -24	-15 -51	-13 -28	
10 ≥ 18 (0.708")	+270 0	+/-9	+/-21,5	+2 -9	+6 -12	-4 -15	0 -18	-5 -23	0 -43	-11 -29	-18 -61	-16 -34	
18 ≥ 30 (1.181")	+330 0	+/-10,5	+/-26	+2 -11	+6 -15	-4 -17	0 -21	-7 -28	0 -52	-14 -35	-22 -74	-20 -41	
30 ≥ 50 (1.969")	+390 0	+/-12,5	+/-31	+3 -13	+7 -18	-4 -20	0 -25	-8 -33	0 -62	-17 -42	-26 -88	-25 -50	
50 ≥ 65 (2.559")	+460 0	+/-15	+/-37	+4 -15	+9 -21	-5 -24	0 -30	-9 -39	0 -74	-21 -51	-32 -106	-30 -62	
65 ≥ 80 (3.150")													
80 ≥ 100 (3.937")	+260 +120	+159 +72	+71 +36	+90 +36	+47 +12	-	+22 0	+35 0	+54 0	+87 0	+140 0	+350 0	
100 ≥ 120 (4.724")													
120 ≥ 140 (5.512")	+305 +145	+185 +85	+83 +43	+106 +43	+54 +14	-	+25 0	+40 0	+63 0	+100 0	+160 0	+400 0	
140 ≥ 160 (6.299")													
160 ≥ 180 (7.087")													
180 ≥ 200 (7.874")	+355 +170	+215 +110	+96 +50	+122 +50	+61 +15	-	+29 0	+46 0	+72 0	+115 0	+185 0	+460 0	
200 ≥ 225 (8.858")													
225 ≥ 250 (9.843")													
250 ≥ 280 (11.0236")	+400 +190	+240 +110	+108 +56	+137 +56	+69 +17	-	+32 0	+52 0	+81 0	+130 0	210 0	+520 0	
280 ≥ 315 (12.402")													
315 ≥ 355 (13.976")	+440 +210	+265 +125	+119 +62	+151 +62	+75 +18	-	+36 0	+57 0	+89 0	+140 0	+230 0	+570 0	
355 ≥ 400 (15.748")													

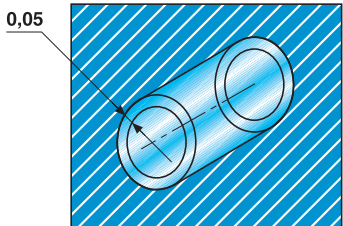
Tolleranze geometriche

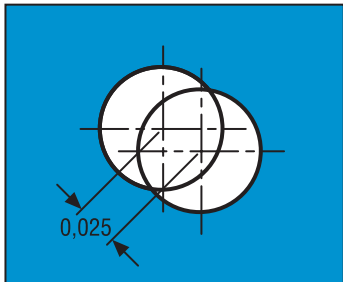
	Simbolo disegno	Area tolleranza	
Circolarità	 <table border="1" data-bbox="805 584 1008 759"> <tr> <td>0,01 mm (0.0004")</td> </tr> </table>	0,01 mm (0.0004")	
0,01 mm (0.0004")			
Cilindricità	 <table border="1" data-bbox="805 999 1008 1173"> <tr> <td>0,05 mm (0.0020")</td> </tr> </table>	0,05 mm (0.0020")	
0,05 mm (0.0020")			
Posizionamento	 <table border="1" data-bbox="805 1426 1008 1601"> <tr> <td>0,05 mm (0.0020")</td> </tr> </table>	0,05 mm (0.0020")	
0,05 mm (0.0020")			

Acciai, acciai inossidabili ferritici e martensitici

SMG	Descrizione	Proprietà	Riferimento	$k_{c1.1}$	m_c
P1	Acciai automatici	$360 < R_m < 880$	11 SMn30 $R_m = 385 \text{ N/mm}^2$	1500	0,14
P2	Acciai basso legati, $C < 0,25\%$ Acciai da costruzione saldabili basso legati	$320 < R_m < 600$	S235JRG2 $R_m = 420 \text{ N/mm}^2$	1600	0,23
P3	Acciai ferritici e ferritico-perlitici, $C < 0,25\%$ Acciai da costruzione saldabili Acciai da cementazione	$430 < R_m < 610$	16 MnCr 5 $R_m = 550 \text{ N/mm}^2$	1800	0,14
P4	Acciai da costruzione basso legati, $0,25\% < C < 0,67\%$ Acciai da bonifica basso legati	$520 < R_m < 1200$	C 45E $R_m = 660 \text{ N/mm}^2$	2000	0,15
P5	Acciai da costruzione, $0,25\% < C < 0,67\%$ Acciai da bonifica	$550 < R_m < 1200$	42 CrMo 4 $R_m = 700 \text{ N/mm}^2$	2020	0,18
P6	Acciai basso legati per tempra a cuore, $C > 0,67\%$ Acciai basso legati per molle e cuscinetti	$520 < R_m < 1200$	C 100S $R_m = 600 \text{ N/mm}^2$	2100	0,17
P7	Acciai per tempra a cuore, $C > 0,67\%$ Acciai per molle e cuscinetti	$600 < R_m < 1200$	100 Cr 6 $R_m = 650 \text{ N/mm}^2$	2160	0,17
P8	Acciai da utensili Acciai super-rapidi (HSS)	$600 < R_m < 1200$	X 40 CrMoV 5 1 $R_m = 700 \text{ N/mm}^2$	2400	0,20
P11	Acciai inossidabili ferritici e martensitici	$415 < R_m < 1200$	X 20 Cr 13 $R_m = 675 \text{ N/mm}^2$	2000	0,15
P12	Acciai inossidabili maraging e per indurimento per precipitazione	$500 < R_m < 1200$	X 5 CrNiCuNb 16 4 $R_m = 1100 \text{ N/mm}^2$	2100	0,17

Acciai inossidabili automatici, austenitici e duplex

SMG	Descrizione	Proprietà	Riferimento	$k_{c1.1}$	m_c
M1	Acciai inossidabili austenitici automatici		X 10 CrNiS 18 9	1700	0,14
M2	Acciai inossidabili austenitici con contenuto di elementi in lega basso		X 5 CrNi 18 10	1920	0,18
M3	Acciai inossidabili austenitici con contenuto di elementi in lega medio		X 2 CrNiMo 18 14 3	2070	0,17
M4	Acciai inossidabili austenitici con contenuto di elementi in lega alto ed acciai inossidabili duplex		X 2 CrNiMoN 22 5 3	2230	0,16
M5	Acciai inossidabili austenitici con contenuto di elementi in lega alto ed acciai inossidabili duplex, di difficile lavorabilità		X 2 CrNiMoN 25 7 4	2510	0,13

Ghise

SMG	Descrizione	Proprietà	Riferimento	$k_{c1.1}$	m_c
K1	Ghise grigie		EN-GJL-250	930	0,32
K2	Ghise a grafite compatta		EN-GJV-400	1000	0,35
K3	Ghise malleabili		EN-GJMB-550-4	1050	0,37
K4	Ghise sferoidali (nodulari)		EN-GJS-500-7	1160	0,37
K5	Ghise austemperate		EN-GJS-1000-5		
K6	Ghise austenitiche lamellari		EN-GJLA-XNiCuCr15-6-2		
K7	Ghise austenitiche sferoidali (nodulari)		EN-GJSA-XNiMn23-4		

Materiali non ferrosi

SMG	Descrizione	Proprietà	Riferimento	$k_{c1.1}$	m_c
N1	Leghe di alluminio, Si < 9%		AW-7075		
N2	Leghe di alluminio, 9% < Si < 16%		AC-44200 Si = 12%		
N3	Leghe di alluminio, Si > 16%		AISI17Cu5		
N11	Leghe di rame		CW614N	740	0,26

Superleghe e titanio

SMG	Descrizione	Proprietà	Riferimento	$k_{c1.1}$	m_c
S1	Superleghe a base ferro		Discalloy		
S2	Superleghe a base cobalto		Stellite 21		
S3	Superleghe a base nichel		Inconel 718	2530	0,21
S11	Titanio, basso legato, (α)		Ti		
S12	Titanio, medio legato, ($\alpha+\beta$)		TiAl6V4	1500	0,24
S13	Titanio, alto legato, ("quasi β " e β)		Ti10V2Fe3Al		

Materiali ad elevata durezza

SMG	Descrizione	Proprietà	Riferimento	$k_{c1.1}$	m_c
H3	Acciai induriti superficialmente	58 < HRC < 62	16 MnCr 5 60 HRC	2070	0,14
H5	Acciai bonificati	38 < HRC < 56	42 CrMo 4 50 HRC	2320	0,18
H7	Acciai bonificati Acciai per cuscinetti	56 < HRC < 64	100 Cr 6 60 HRC	2480	0,17
H8	Acciai da utensili Acciai super-rapidi (HSS)	38 < HRC < 64	X 40 CrMoV 5 1 50 HRC	2750	0,20
H11	Acciai inossidabili martensitici	38 < HRC < 50	X 20 Cr 13 45 HRC	2300	0,15
H12	Acciai inossidabili maraged ed induriti per precipitazione	1200 < R _m < 1650	X 5 CrNiCuNb 16 4 R _m = 1450 N/mm ²	2410	0,17
H21	Acciai al manganese	23 < HRC < 64	X 120 Mn 12 50 HRC		
H31	Ghise bianche	50 < HRC < 64	EN-GJN-HV600(XCr11) 55 HRC		

Altri materiali di difficile lavorabilità

SMG	Descrizione	Proprietà	Riferimento	$k_{c1.1}$	m_c
PM1	Materiali da metallurgia delle polveri con contenuto di elementi in lega basso		F-0008 Fe-0.7C		
PM2	Materiali da metallurgia delle polveri con contenuto di elementi in lega medio		FLC-4608 Fe2Cu1.8Ni 0.5Mo0.2Mn0.8C		
PM3	Materiali da metallurgia delle polveri con contenuto di elementi in lega alto Materiali per sedi valvole di scarico				
HF1	Leghe per riporti duri Riporto di leghe a base ferro mediante saldatura o plasma				
HF2	Leghe per riporti duri Riporto di leghe a base cobalto o nichel mediante saldatura o plasma				
CC1	Metallo duro		G50		

Plastiche e materiali compositi

SMG	Descrizione	Proprietà	Riferimento	$k_{c1.1}$	m_c
TS1	Polimeri termoindurenti		Urea formaldeide (UF)		
TS2	Compositi di resina termoindurente rinforzata con fibra di carbonio		T300 T700 T800 HTA-S IMA - Resina epossidica (M21)...		
TS3	Compositi di resina termoindurente rinforzata con fibra di vetro		Resina epossidica - HX..(42..)/vetro E (7781...)...		
TS4	Compositi di resina termoindurente rinforzata con fibra aramidica		Kevlar 49		
TP1	Polimeri termoplastici		Policarbonato (PC)		
TP2	Compositi di resina termoplastica rinforzata con fibra di carbonio		PPS/PEEK - T300..		
TP3	Compositi di resina termoplastica rinforzata con fibra di vetro		PPS/PEEK - vetro E o A...		
TP4	Compositi di resina termoplastica rinforzata con fibra aramidica				

Grafite

SMG	Descrizione	Proprietà	Riferimento	$k_{c1.1}$	m_c
GR1	Grafite		R 8500		

SMG

Gruppo materiale Seco	EN	EN-Nr	W.-Nr	DIN	AFNOR	BS	UNI	JIS	SS	UNS
P1	11 SMn 30	1.0715	1.0715	9 SMn 28	S 250	230 M 07	CF 9 SMn 28	SUM 22	1912	G12130
	11 SMnPb 30	1.0718	1.0718	9 SMnPb 28	S 250 Pb		CF 9 SMnPb 28	SUM 22 L	1914	G12134
	10 S 20	1.0721	1.0721	10 S 20	10 F 1	210 M 15	CF 10 S 20			
			1.0722	10 SPb 20	10 PbF 2		CF 10 SPb 20			
	15 SMn 13	1.0725	1.0723	15 S 20		210 A 15		SUM 32	1922	
	35 S20	1.0726	1.0726	35 S 20	35 MF 4	212 M 36			1957	G11400
	46 S20	1.0727	1.0727	46 S 20	45 MF 4	212 M 44			1973	G11460
	11 SMn 37	1.0736	1.0736	9 SMn 36	S 300	240 M 07	CF 9 SMn 36			G12150
11 SMn 37	1.0736	1.0736	9 SMn 36	S 300	240 M 07	CF 9 SMn 36			G12150	
P2	S235JR	1.0037	1.0037	St 37-2	E 24-2		Fe 360 B	STKM 12 C	1311	
	S235JRG2	1.0038	1.0116	St 37-3	E 24-3, E 24-4	4360-40 C	Fe 360 D FF		1312, 1313	
	S275J2G3	1.0144	1.0144	St 44-3 N	E 28-3, E 28-4	4360-43 C	Fe 430 D FF	SM 41 C	1412, 1414	
	C 10	1.0301	1.0301	C 10	34 C 10, XC 10	045 M 10	C 10	S 10 C		G10100
			1.0401	C 15	37 C 12, XC 18	080 M 15	C 15, C 16		1350	G10170
	C22	1.0402	1.0402	C 22	C 20	050 A 20	C 20, C 21		1450	G10200
	S355JR	1.0570	1.0570	St 52-3	E 36-3, E 36-4	4360-50 C	Fe 510 B	SM 50 YA	2172, 2132	
	C 15R	1.1141	1.1141	Ck 15	XC 15, XC 18	080 M 15	C 15, C 16	S 15 C, S 15 CK	1370	G10170
			1.1158	Ck 25	XC 25	060 A 25	C 25	S 25 C		G10250
		1.2162	21 MnCr 5	20 NC 5				SCR 420 H		
P3	16 Mo 3	1.5415	1.5415	15 Mo 3	15 D 3	1501-240	16 Mo 3		2912	
			1.5423	16 Mo 5		1503-245-420	16 Mo 5	SB 450 M		G45200
	14 NiCr 14	1.5752	1.5752	14 NiCr 14	12 NC 15	655 M 13		SNC 815 (H)		G33106
			1.5919	15 CrNi 6	16 NC 6	S 107	16 CrNi 4			
	18 NiCrMo 7 6	1.6587	1.6587	18 CrNiMo 7 6	18 NCD 6	820 A 16	18 NiCrMo 7			
	16 MnCr 5	1.7131	1.7131	16 MnCr 5	16 MC 5	527 M 17	16 MnCr 5	SCR 415	2511	G51170
	16 MnCrS 5	1.7139	1.7139	16 MnCrS 5						
	20 MnCr 5	1.7147	1.7147	20 MnCr 5	20 MC 5		20 MnCr 5	SMnC 420 (H)		G51200
20 MnCrS 5	1.7149	1.7149	20 MnCrS 5	20 MnCrS 5			SMnC 21 H			
13 CrMo 4 5	1.7335	1.7335	13 CrMo 4 4	15 CD 3.5	1501-620 Gr. 27	14 CrMo 4 5		2216		
		1.7337	16 CrMo 4 4	15 CD 4.5	1501-620 Gr. 27	14 CrMo 4 5		2216		
10 CrMo 9 10	1.7380	1.7380	10 CrMo 9 10	10 CD 9.10	1501-622 Gr. 31	12 CrMo 9 10		2218	J21890	
P4	C35		1.0501	C 35	55 C 35	060 A 35	C 35		1550	G10350
	E 335	1.0503	1.0503	C 45	65 C 45	80 M 46	C 45	S 45 C	1650	G10430
	C40		1.0511	C 40	60 C 40	080 M 40	C 40	S 40 C		
	E 360	1.0070	1.0535	St 70-2	A 70-2		Fe 690		1655	
	C60	1.0601	1.0601	C 60	CC 55	080 A 62	C 60			G10600
			1.1157	40 Mn 4	35 M 5	150 M 36				G10390
	G 28 Mn6	1.1165	1.1165	30 Mn 5		120 M 36		SMn 1 H, SCMn 2		G13300
	C 35E	1.1181	1.1181	Ck 35	XC 38 H1	080 M 36	C 35	S 35 C	1572	G10340
C 45E	1.1191	1.1191	Ck 45	XC 42	080 M 46	C 45	S 45 C	1672	G10420	
C 60E	1.1221	1.1221	Ck 60	XC 60	080 A 62	C 60	S 58 C	1665, 1678	G10640	
		1.1740	C 60 W	Y3 55				SK 7		
P5	55 SiCr7	1.7100	1.0904	55 Si 7	55 S 7	250 A 53	55 Si 8		2085, 2090	
			1.2330	35 CrMo 4	34 CD 4	708 A 37	35 CrMo 4		2234	T51620
			1.2542	45 WCrV 7		BS 1	45 WCrV 8 KU		2710	T41901
		1.2714	1.2714	56 NiCrMoV 7		BH 224-5	56 NiCrMoV7-KU	SKT 4		T61206
			1.5121	46 MnSi 4						
			1.5710	36 NiCr 6	35 NC 6	640 A 35			SNC 236	
			1.5736	36 NiCr 10	35 NC 11				SNC 631 (H)	
	36 CrNiMo 4		1.6511	36 CrNiMo 4	40 NCD 3	816 M 40	38 NiCrMo 4 (KB)			G98400
34 CrNiMo 6	1.6582	1.6582	34 CrNiMo 6	35 NCD 6	817 M 40	35 NiCrMo 6 (KW)	SNCM 447	2541	G43400	
34 Cr 4	1.7033	1.7033	34 Cr 4	32 C 4	530 A 32	34 Cr 4 (KB)	SCR 430 (H)		G51320	
41 Cr 4	1.7035	1.7035	41 Cr 4	42 C 4	530 M 40	41 Cr 4	SCR 440 (H)		G51400	
25 CrMo 4	1.7218	1.7218	25 CrMo 4	25 CD 4 S	708 M 25	25 CrMo 4 (KB)	SCM 425	2225	G41300	
42 CrMo 4	1.7225	1.7225	42 CrMo 4	42 CD 4	708 M 40	42 CrMo 4	SCM 440 (H)	2244	G41400	
42 CrMo 4	1.7225	1.7225	42 CrMo 4	42 CD 4	708 M 40	42 CrMo 4	SCM 440 (H)	2244	G41400	
		1.7361	32 CrMo 12	30 CD 12	722 M 24	32 CrMo 12		2240		
50 CrV 4	1.8159	1.8159	50 CrV 4	50 CV 4	735 A 50	51 CrV 4	SUP 10	2230	H61500	
41 CrAlMo 7 10	1.8509	1.8509	41 CrAlMo 7	40 CAD 6.12	905 M 39	41 CrAlMo 7	SACM 645	2940	K24065	
C 67S	1.1231	1.1231	Ck 67	XC 68	060 A 67	C 70		1770	G10700	
C 100S	1.1274	1.1274	Ck 101		060 A 96		SUP 4	1870	G10950	
C 105U	1.1545	1.1545	C 105 W1	Y1 105				1880		
		1.1645	C 105 W2	Y1 105						
		1.1663	C 125 W	Y2 120						

Introduzione

Foratura

Alesatura

Barenatura

Allegato

SMG

U.N.E./I.H.A.	AISI / ASTM	GOST	ČSN	Marchi misti	Condizione	Struttura
	1213				Ricotto	
	12 L 13				Ricotto	
	1108				Ricotto	
	11 L 08				Ricotto	
					Ricotto	
	1140	40			Ricotto	
	1146				Ricotto	
	1215				Ricotto	
	12 L 14				Ricotto	
		16D			Ricotto	
	A573 Grade 58	18kp	11 378		Ricotto	
	A573 Grade 70	St14kP	11 448		Ricotto	
	1010	10			Ricotto	
F.1110	1015	15			Ricotto	
	1020, 1023	20	12 024		Ricotto	
		17G1S	11 523		Ricotto	
F.1511	1015	15			Ricotto	
F.1120	1025	25			Ricotto	
					Ricotto	
	A204 Grade A		15 020		Ricotto	
	4520				Ricotto	
	3310, 9314	20X2H4A	16 420		Ricotto	
	4320		16 220		Ricotto	
					Ricotto	
F.1516	5115	12KHN2	14 220		Ricotto	
		18HG			Ricotto	
	5120	20KH	14 221		Ricotto	
	5120 H	20KH			Ricotto	
	A182-F11, A182-F12	12KHM	15 121		Ricotto	
	A387 Grade 12 Cl. 2				Ricotto	
F.155	A182-F22	12KH8	15 313		Ricotto	
F.1130	1035	35	12 040		Ricotto	
F.5110	1045	45	12 050		Ricotto	
	1040	40	12 041		Ricotto	
F.1150	1055	55			Ricotto	
	1060	60	12 061		Ricotto	
	1039	40G			Ricotto	
	1330	30G2			Ricotto	
F.1135	1035	35			Ricotto	
F.1140	1045	45	12 050		Ricotto	
F.1150	1064	60			Ricotto	
	1060	60			Ricotto	
F.144	9255	55S2			Ricotto	
F.1250	4135	35KHM			Ricotto	
F.5241	S1	5KHV2S			Ricotto	
	L6	5KHNV			Ricotto	
	5045				Ricotto	
	3135				Bonificato	
	3435				Ricotto	
	9840				Bonificato	
F.1280	4340	38H2N2MA	16 343		Ricotto	
	5132	35KH			Bonificato	
	5140	40H	14 140		Bonificato	
F.1251	4130	20KHM	15 130		Bonificato	
F.1252	4142, 4140	38HM	15 142		Ricotto	
F.1252	4142, 4140	38HM	15 142		Bonificato	
					Bonificato	
F.143	6150	50KHFA	15 260		Bonificato	
F.1740	A355 Cl. A				Ricotto	
F.5103	1070	70			Ricotto	
F.5117	1095				Ricotto	
F.5118	W1	U10A			Ricotto	
		U10			Ricotto	
	W1	U13			Ricotto	

Introduzione

Foratura

Alesatura

Barenatura

Allegato

SMG

SMG	EN	EN-Nr	W.-Nr	DIN	AFNOR	BS	UNI	JIS	SS	UNS	
P7	107 CrV 3	1.2210	1.2210	115 CrV 3	100 C 3		107 CrV 3 KU			T61202	
			1.2510	100 MnCrW 4	90 MWCV 5	BO 1	95 MnWCr 5 KU	SKS 3	2140	T31501	
	90 MnCrV 8	1.2842	1.2842	90 MnCrV 8	90 MV 8	BO 2	90 MnVCr 8 KU			T31502	
	100 Cr 6	1.3505	1.3505	100 Cr 6	100 C 6	534 A 99	100 Cr 6	SUJ 2	2258	G51986	
P8	X 210 Cr 12	1.2080	1.2080	X 210 Cr 12	Z 200 C 12	BD 3	X 210 Cr 13 KU	SKD 1		T30403	
			1.2343	X 38 CrMoV 5 1	Z 38 CDV 5	BH 11	X 37 CrMoV 5 1 KU	SKD 6		T20811	
	X 40 CrMoV 5 1	1.2344	1.2344	X 40 CrMoV 5 1	Z 40 CDV 5	BH 13	X 40 CrMo 5 1 1 KU	SKD 61	2242	T20813	
	X 100 CrMoV 5	1.2363	1.2363	X 100 CrMoV 5 1	Z 100 CDV 5	BA 2	X 100 CrMoV 5 1 KU	SKD 12	2260	T30102	
			1.2365	X 32 CrMoV 3 3	32 DCV 28	BH 10	30 CrMoV 12 27 KU	SKD 7		T20810	
			1.2436	X 210 CrW 12			X 215 CrW 12 1 KU	SKD 2		2312	
			1.2601	X 165 CrMoV 12			X 165 CrMoV 12 KU			2310	
			1.2713	55 NiCrMoV 6	55 NCDV 7			SKT 4			T61206
	HS 6-5-2-5	1.3243	1.3243	S 6-5-2-5	Z 85 WDKCV 06-05-05-04-02		HS 6-5-2-5	SKH 55		2723	
	HS 2-10-1-8	1.3247	1.3247	S 2-10-1-8	Z 110 DKCWW 09-08-04	BM 42	HS 2-9-1-8	SKH 51			T11342
HS 18-1-2-5	1.3255	1.3255	S 18-1-2-5	Z 80 WKCW 18-05-04-01	BT 4	HS 18-1-1-5	SKH 3			T12004	
HS 6-5-2	1.3343	1.3343	S 6-5-2	Z 85 WDCV 06-05-04-02	BM 2	HS 6-5-2	SKH 9, SKH 51		2722	T11302	
HS 2-9-2	1.3348	1.3348	S 2-9-2	Z 100 DCWW 09-04-02-02		HS 2-9-2	SKH 58		2782	T11307	
HS 18-0-1	1.3355	1.3355	S 18-0-1	Z 80 WCV 18-04-01	BT 1	HS 18-0-1	SKH 2			T12001	
P11	X 6 Cr 13	1.4000	1.4000	X 6 Cr 13	Z 6 C 12	403 S 17	X 6 Cr 13	SUS 403	2301	S41008	
	X 12 Cr 13	1.4006	1.4006	X 10 Cr 13	Z 10 C 13	410 S 21	X 12 Cr 13	SUS 410	2302	S41000	
	X 6 Cr 17	1.4016	1.4016	X 6 Cr 17	Z 8 C 17	430 S 15	X 8 Cr 17	SUS 430	2320	S43000	
	X 20 Cr 13	1.4021	1.4021	X 20 Cr 13	Z 20 C 13	420 S 37	X 20 Cr 13	SUS 420 J 1	2303	S42000	
	X 39 Cr 13	1.4031	1.4031	X 40 Cr 13	Z 40 C 14	420 S 45	X 40 Cr 14	SUS 420	2304	S40280	
	X 70 CrMo 15	1.4109	1.4109	X 65 CrMo 14	Z 70 D 14			SUS 440 A		S44002	
	X 90 CrMoV 18	1.4112	1.4112	X 90 CrMoV 18	Z 2 CND 18 05	409 S 19	X CrTi 12	SUS 440 B	2327	S44003	
	X 105 CrMo 17	1.4125	1.4125	X 105 CrMo 17	Z 100 CD 17		X 105 CrMo 17	SUS 440 C		S44004	
	X 3 CrNiMo 13 3	1.4313	1.4313	X 5 CrNi 13 4	Z 5 CN 13 4	425 C 11	X 6 CrNi 13 04	SCS 5		2385	S41500
	X 18 CrN 28	1.4749	1.4749	X 18 CrN 28	Z 18 C 25					2322	S44600
P12	X 6 NiCrTiMoV 25 15	1.4534	1.4534	X 3 CrNiMoAl 13 8 2						S13800	
	X 4 CrNiCuNb 16 4	1.4540	1.4540	X 4 CrNiCuNb 16 4						S15500	
		1.4540	1.4540	X 4 CrNiCuNb 16 4	Z 4 CNUNb 16.4 M					S15500	
	X 4 CrNiCuNb 16 4	1.4540	1.4540	X 4 CrNiCuNb 16 4						S15500	
	X 5 CrNiCuNb 16 4	1.4542	1.4542	X 5 CrNiCuNb 16 4				SUS 630		S17400	
	X 5 CrNiCuNb 17 4	1.4548	1.4548	X 5 CrNiCuNb 17 4	Z 6 CNU 17.4			SCS 24, SUS 630		S17400	
	X 7 CrNiAl 17 7	1.4564	1.4564	X 7 CrNiAl 17 7	Z 9 CAN 17.7	301 S 81	X 7 CrNiAl 17 7	SUS 631	2388	S17700	
	X 2 NiCoMoTi 18 12 4	1.6356	1.6356	X 2 NiCoMoTi 18 12 4							K93160
	X 2 NiCoMoTi 18 9 5	1.6358	1.6358	X 2 NiCoMoTi 18 9 5	Z 2 NKD 19-09						K93120
	X 2 NiCoMo 18 9 5	1.6358	1.6358	X 2 NiCoMoTi 18 9 5	Z 2 NKD 19-09						K93120
	X 2 NiCoMo 18 8 5	1.6359	1.6359	X 2 NiCoMo 18 8 5		S 162					K92890
	X 2 NiCoMo 18 8 5	1.6359	1.6359	X 2 NiCoMo 18 8 5		S 162					K92890
M1	X 10 CrNiS 18 9	1.4305	1.4305	X 10 CrNiS 18 9	Z 10 CNF 18.09	303 S 31	X 10 CrNi 18 09	SUS 303	2346	S30300	
	X 2 CrNi 19 11	1.4306	1.4306	X 2 CrNi 19 11	Z 2 CN 18.10	304 S 12	X 3 Cr Ni 18 11	SUS 304 L	2352	S30403	
M2	X 5 CrNi 18 10	1.4301	1.4301	X 5 CrNi 18 10	Z 6 CN 18.09	304 S 31	X 5 CrNi 18 11	SUS 304	2333	S30400	
	X 5 CrNiMo 17 12 2	1.4401	1.4401	X 5 CrNiMo 17 12 2	Z 3 CND 17.11.1	316 S 31	X 5 CrNiMo 17 12	SUS 316	2347	S31600	
	X 6 CrNiNb 18 10	1.4550	1.4550	X 6 CrNiNb 18 10	Z 6 CNNb 18.10	347 S 31	X 6 CrNiNb 18 11	SUS 347	2338	S34700	
	X 9 CrNi 18 8	1.4310	1.4310	X 12 CrNi 17 7	Z 12 CN 17.07	301 S 21	X 12 CrNi 17 07	SUS 301	(2331)	S30100	
	X 12 CrNi 18 8	1.4300	1.4300	X 12 CrNi 18 8	Z 12 CN 18	302 S 25		SUS 302		2331	S30200
	X 2 CrNiMo 18 14 3	1.4435	1.4435	X 2 CrNiMo 18 14 3	Z 2 CND 17.13	316 S 12	X 2 CrNiMo 17 13 2	SCS 16, SUS 316 L	2353	S31603	
M3	X 2 CrNiMoN 17 13 3	1.4429	1.4429	X 2 CrNiMoN 17 13 3	Z 2 CND 17.13 Az	316 S 62	X 2 CrNiMoN 17 13 3	SUS 316 LN	2375	S31653	
	X 2 CrNiN 18 10	1.4311	1.4311	X 2 CrNiN 19 11	Z 2 CN 18 .10 Az	304 S 62	X 2 CrNiN 18 11	SUS 304 LN	2371	S30453	
	X 3 CrNiMo 18 12 3	1.4466	1.4466	X 5 CrNi 18 15		317 S 16	X 5 CrNi 18 15	SUS 317	2366	S31700	
	X 9 CrNiSiN 21 11 2	1.4835	1.4893	X 9 CrNiSiN 21 11 2		310 S 31				2368	S30815
	X 12 CrNi 25 21	1.4335	1.4335	X 12 CrNi 25 21	Z 12 CN 25.20	310 S 24	X 6 CrNi 26 20	SUH 310, SUS 310 S	2361	S31008	
M4	X 2 CrNiMoN 22 5 3	1.4462	1.4462	X 2 CrNiMoN 22 5	Z 2 CND 22.05 Az	332 S 15	X 2 CrNiMoN 22 5			2377	S31803
	X 2 CrNiMoSi 19 5	1.4424	1.4417	X 2 CrNiMoSi 19 5	Z 2 CND 18.05.03					2376	S31500
	X 2 NiCrMoCu 25 20 5	1.4539	1.4539	X 2 NiCrMoCu 25 20 5	Z 2 NCDU 25 20	904 S 13				2562	N08904
	X 3 CrNiMo 27 5 2	1.4460	1.4460	X 4 CrNiMo 27 5 2	Z 3 CND 25.7 Az		X 3 CrNiMo 27 5 2	SUS 329 J 1	2324	S32900	
	X 5 CrNiCuNb 16 4	1.4980	1.4943	X 4 NiCrTi 25 15	Z 6 NCTDV 25.15	HR 51		SUH 660	2570	S66286	
M5	X 1 CrNiMoN 20 18 7	1.4547	1.4529	X 1 CrNiMoN 20 18 7	Z 1 CNDU 20.18.05 Az		X 1 CrNiMoN 20 18 7			2778	S31254
	X 1 CrNiMoN 25 22 8	1.4652	1.4652	X 2 CrNiMoN 25 22 7							S32654
	X 10 NiCrAlTi 32 20	1.4876	1.4876	X 10 NiCrAlTi 32 20	Z 10 NC 32.21			NCF 800			N08800
	X 2 CrNiMoN 25 7 4	1.4410	1.4410	X 2 CrNiMoN 25 7 4	Z 3 CND 25.07 Az		X 2 CrNiMoN 25 7 4		2328	S32750	

Introduzione

Foratura

Alesatura

Barenatura

Allegato

SMG

U.N.E./I.H.A.	AISI / ASTM	GOST	ČSN	Marchi misti	Condizione	Struttura
F.520L	L2	11KHF			Ricotto	
F.5220	O1	9KHVG			Ricotto	
	O2	9G2F			Ricotto	
F.5230	52100	SHKH15	14 109		Ricotto	
F.5212	D3	KH12			Ricotto	
	H11	4KH5MFS			Ricotto	
F.5318	H13	4KH5MF1S			Ricotto	
F.5227	A2	9KH5VF			Ricotto	
	H10	3KH3M3F			Ricotto	
F.5213		KH12			Ricotto	
		KH12MF			Ricotto	
F.520.S	L6	5KHNM			Ricotto	
F.5613	M35	R6M5K5			Ricotto	
	M42	R2AM9K5			Ricotto	
	T4	R18K5F2			Ricotto	
F.5603	M2	R6M5			Ricotto	
	M7				Ricotto	
	T1	R18			Ricotto	
	403	08KH13			Ricotto	Ferritico
F.3401	410, CA-15	12KH13, 08KH13			Ricotto	Martensitico
F.3113	430	12KH17			Ricotto	Ferritico
F.5261	420	20KH13	17 022		Ricotto	Martensitico
F.3404	420	40KH13			Ricotto	Martensitico
	440 A				Ricotto	Martensitico
	440 B	95KH18			Ricotto	Martensitico
	440 C	95KH18			Ricotto	Martensitico
	A182 F6NM			F6NM	Ricotto	Martensitico
	446	15KH28			Ricotto	Ferritico
	XM-13			PH 13-8 Mo	Ricotto solubilizzato	Austenitico
	XM-12			15-5 PH	H1150	Martensitico
	XM-12			15-5 PH	Ricotto solubilizzato	Martensitico
	XM-12			15-5 PH	H1025	Martensitico
	SAE 630			17-4 PH	H1150	Martensitico
	630			17-4 PH	Ricotto solubilizzato	Martensitico
	631	09KH17N7YU1		17-7 PH	Ricotto solubilizzato	Austenitico/Ferritico
	AMS 6515			Marage 350	Ricotto solubilizzato	Martensitico
	AMS 6521			Marage 300	Ricotto solubilizzato	Martensitico
	AMS 6514			Marage 300, Vascomax C300	Ricotto solubilizzato	Martensitico
	AMS 6512			Marage 250	Ricotto solubilizzato	Martensitico
	AMS 6512			Marage 250, Vascomax C250	Ricotto solubilizzato	Martensitico
F.3508	303	12KH19N9			Ricotto	Austenitico
F.3504	304 L	03KH18N11			Ricotto	Austenitico
F.3504	304	08KH18N10	17 240		Ricotto	Austenitico
F.3534	316	08KH17H13M2T	17 346		Ricotto	Austenitico
F.3524	347	08KH18N12B			Ricotto	Austenitico
F.3517	301	07KH16N6			Ricotto	Austenitico
	302	12KH18N9			Ricotto	Austenitico
F.3533	(316 L)	03KH17N14M3	17 349		Ricotto	Austenitico
	316 LN	03KH16N15M3			Ricotto	Austenitico
F.3541	304 LN	03KH18N11			Ricotto	Austenitico
	317	08KH17H15M3T			Ricotto	Austenitico
				253 MA	Ricotto	Austenitico
	310 S	12KH25N20			Ricotto	Austenitico
	329 LN			SAF 2205	Ricotto	Duplex
				3RE60	Ricotto	Duplex
	904L				Ricotto	Super austenitico
	329				Ricotto	Duplex
	660			A286	Ricotto solubilizzato	Austenitico
				254 SMO	Ricotto	Super austenitico
				654 SMO	Ricotto	Super austenitico
				Alloy 800	Ricotto	Austenitico
	F 53			SAF 2507	Ricotto	Super duplex

Introduzione

Foratura

Alesatura

Barenatura

Allegato

SMG

SMG	EN	EN-Nr	W.-Nr	DIN	AFNOR	BS	UNI	JIS	SS	UNS	
K1	EN-GJL-150	0.6150	0.6150	GG-15	Fl 15 D	Grade 150	G15	FC 150	01 15-00	F11601	
	EN-GJL-200	0.6200	0.6200	GG-20	Fl 20 D	Grade 220	G20	FC 200	01 20-00	F12101	
	EN-GJL-250	0.6250	0.6250	GG-25	Fl 25 D	Grade 260	G25	FC 250	01 25-00	F12401	
	EN-GJL-350	0.6350	0.6350	GG-35	Fl 35 D	Grade 350	G35	FC 350	01 35-00	F13502	
	EN-GJL-215			GG-220 HB					02 19		
K2	EN-GJV-300			GJV-300							
	EN-GJV-350			GJV-350							
	EN-GJV-400			GJV-400							
	EN-GJV-450			GJV-450							
	EN-GJV-500			GJV-500							
K3	EN-GJMB-550-4	0.8155		GTS-55-04	P 540/5	P 540/5	P 55-04	PCMP55-04	08 54-00	F24130	
K4	EN-GJS-350-22	0.7033	0.7033	GGG-35.3	FGS 370-17	Grade 350/22		FCD 350-22L	07 17-15		
	EN-GJS-400-15	0.7040	0.7040	GGG-40	FGS 400-12	Grade 420/12	GS 400-12	FCD 400-18L	07 17-02	F32800	
	EN-GJS-400-18	0.7043	0.7043	GGG-40.3	FGS 370-17	Grade 370/17	GSO 42/17		07 17-12	F32800	
	EN-GJS-500-7	0.7050	0.7050	GGG-50	FGS 500-7	Grade 500/7	GS 500-7	FCD 500-7	07 27-02	F33800	
	EN-GJS-600-3	0.7060	0.7060	GGG-60	FGS 600-3	Grade 600/3	GS 600-3	FCD 600-3	07 32-03	F34100	
	EN-GJS-700-2	0.7070	0.7070	GGG-70	FGS 700-2	Grade 700/2	GS 700-2	FCD 700-2	07 37-01	F34800	
K5	EN-GJS-1000-5			GJS-1000-5						ADI grade 5	
	EN-GJS-1200-2			GJS-1200-2						ADI grade 2	
	EN-GJS-1400-1			GJS-1400-1						ADI grade 3	
	EN-GJS-800-8			GJS-800-8						ADI grade 4	
											ADI grade 1
K6	EN-GJLA-XNiCr 20-2	0.6660	0.6660	GGL-NiCr 20 2	FGL Ni20 Cr2	Grade F2			05 23-00	F41002	
	EN-GJLA-XNiCr 30-3	0.6676	0.6676	GGL-NiCr 30 3	FGL Ni30 Cr3	Grade F3				F41004	
	EN-GJLA-XNiCuCr 15-6-2	0.6655	0.6655	GGL-NiCuCr 15 6 2	FGL Ni15 Cu6 Cr2	Grade F1				F41000	
K7	EN-GJSA-XNiMn 13-7	0.7652	0.7652	GGG-NiMn 13 7	FGS Ni13 Mn7	Grade S6			07 72-00		
	EN-GJSA-XNiCr 20-2	0.7660	0.7660	GGG-NiCr 20 2	FGS Ni20 Cr2	Grade S2				F43000	
	EN-GJSA-XNiMn 23-4	0.7673	0.7673	GGG-NiMn 23 4	FGS Ni23 Mn4	Grade S2M				F43010	
	EN-GJSA-XNiCr 30-3	0.7676	0.7676	GGG-NiCr 30 3	FGS Ni30 Cr3	Grade S3				F43003	
	EN-GJSA-XNi 35	0.7683	0.7683	GGG-Ni 35	FGS Ni35					F43006	
N1	AW-1050A	Al99.5	3.0255	Al99.5	A-5/1050A	1B		(A1050)	4007	AA1050A	
	AW-2011	AlCuBiPb	3.1655	AlCuBiPb	A-U5PbBi/2011	FC1		A2011	4355	AA2011	
	AW-2014	AlCuSiMn	3.1255	AlCuSiMn	A-U4SG/2014	H15			4338	AA2014	
	AW-5005	AlMg1	3.3315	AlMg1	A-G0.6	N41			4106	AA5005	
	AW-6060	AlMgSi0.5	3.3206	AlMgSi0.5	A-GS/6060	(H9)			4103	AA6060	
	AW-6063	AlMgSi0.7	3.3210	AlMgSi0.7	A-GSUC/6061	(H10)		(A6063)	4104, 4107	AA6005	
	AW-3103	AlMn1	3.0515	AlMn1		N3			4054	AA3103	
	AW-3003	AlMn1Cu	3.0517	AlMn1Cu	A-M1/3003			A3003		AA3003	
	AW-7020	AlZn4.5Mg1	3.4335	AlZn4.5Mg1	A-Z5G/7020	H17			4425	AA7020	
	AW-7075		3.4365	AlZnMgCu1.5	A-Z5GU/7075	2L95/2L96			A7075	AA7075	
	AC-42000		3.2341	G-AlSi5Mg	A-S7G	LM25	3599		AC 4C	4244	
	AC-46200	AlSi8Cu3(Si)	3.2161	G-AlSi8Cu3						4251	A13800
	MG-P-63	MgAl6Zn	3.5612	G-MgAl6Zn	G-A6-Z1	MAG-E-121					M11600
	MG-P-61	MgAl8Zn	3.5812	G-MgAl8Zn	(G-A7-Z1)						
	MN65120	MgSe3Zn2Zr1	3.5103	G-MgSe3Zn2Zr1	ZRE1	MAG6-TE					M12330
	AC-43400	AlSi10Mg(Fe)	3.2381	G-AlSi10Mg	A-S10G	LM9				4253	A13600
	AC-44200	AlSi12	3.2382	GD-AlSi12							
	AW-6082	AlMgSi1	3.2315	AlMgSi1	A-SGM0.7/6082	H30				4212	AA6082
	N3	AlSi17Cu5							ADC14		
	N11	CC331G		2.0940.01	CuAl10Fe	CuAl10Fe	AB1			5710	C95200
CC333G			2.0975.01	CuAl10Ni	CuAl10Ni5Fe5	AB2			5716	C95500	
		CuNi10Fe1Mn	2.0872	CuNi10Fe1Mn	CuNi10Fe1Mn	CN102			5667	C70600	
				CuNi10Zn45							
		CW408J	2.0790	CuNi18Zn19Pb	CuNi18Zn19Pb1						C76300
CW352H			2.1176	CuPb10Sn	CuSn10Pb10	LB2			5640	C93700	
CC480K			2.1050.01	CuSn10	CuSn10	CT1			5443	C90700	
			2.1087	CuSn10Zn					5458	C90500	
CW452K		CuSn6	2.1020	CuSn6	CuSn6	PB103		C5191	5428	C51900	
CW502L		CuZn15	2.0240	CuZn15	CuZn15	CZ102		C2300	5112	C23000	
CW706R		CuZn28Sn1	2.0470	CuZn28Sn1	CuZn29Sn1				5220	C44300	
CW508L		CuZn37	2.0321	CuZn37	CuZn37	CZ108			5150	C27200	
CW717R		CuZn38Sn1	2.0530	CuZn38Sn1						C46400	
CW614N		CuZn39Pb3	2.0401	CuZn39Pb3	CuZn39Pb3	CZ121			5170	C38500	
CW612N		CuZn40Pb2	2.0402	CuZn40Pb2	CuZn39Pb2	CZ120			5168	C37800	
CW622N		CuZn44Pb2	2.0410	CuZn44Pb2		CZ104			5272	C68700	

Introduzione

Foratura

Alesatura

Barenatura

Allegato

SMG

SMG	EN	EN-Nr	W.-Nr	DIN	AFNOR	BS	UNI	JIS	SS	UNS	
S1											
S2											
S3	NiMo30		2.4810							N10002	
	NiMo16Cr15W		2.4819							N10276	
	NiCr19Fe19Nb5Mo3		2.4668							N07718	
	NiCr20TiAl		2.4669							N07750	
				2.4631							N07080
	NiCr19Co18Mo4Ti3Al3										N07500
			2.4654							N07001	
S11										R54620	
										R56320	
S12										R56400	
	TiAl6V4		3.7164								
S13				TiV10Fe2Al3							
H3	16 MnCr 5	1.7131	1.7131	16 MnCr 5	16 MC 5	527 M 17	16 MnCr 5	SCR 415	2511	G51170	
H5	C 67S	1.1231	1.1231	Ck 67	XC 68	060 A 67	C 70		1770	G10700	
	C 75S	1.1248	1.1248	Ck 75	XC 75	060 A 78	C 75		1774, 1778	G10780	
	C 100S	1.1274	1.1274	Ck 101		060 A 96		SUP 4	1870	G10950	
	C 105U	1.1545	1.1545	C 105 W1	Y1 105		C 100 KU		1880		
			1.2550		60 WCrV 7	55 WC 20		55 WCrV 8 KU			
	55 Cr 3	1.7176	1.7176	55 Cr 3	55 C 3	527 A 60	55 Cr 3	SUP 9 (A)	2253	G51550	
	42 CrMo 4	1.7225	1.7225	42 CrMo 4	42 CD 4	708 M 40	42 CrMo 4	SCM 440 (H)	2244	G41400	
	107 CrV 3	1.2210	1.2210	115 CrV 3	100 C 3		107 CrV 3 KU			T61202	
H7			1.2510	100 MnCrW 4	90 MWCV 5	BO 1	95 MnWCr 5 KU	SKS 3	2140	T31501	
		1.2842	1.2842	90 MnCrV 8	90 MV 8	BO 2	90 MnVCr 8 KU			T31502	
		1.3505	1.3505	100 Cr 6	100 C 6	534 A 99	100 Cr 6	SUJ 2	2258	G51986	
H8	X 40 CrMoV 5 1	1.2344	1.2344	X 40 CrMoV 5 1	Z 40 CDV 5	BH 13	X 40 CrMo 5 1 1 KU	SKD 61	2242	T20813	
	X 100 CrMoV 5	1.2363	1.2363	X 100 CrMoV 5 1	Z 100 CDV 5	BA 2	X 100 CrMoV 5 1 KU	SKD 12	2260	T30102	
	X 155 CrVMo 12 1		1.2379	X 155 CrVMo 12 1	Z 160 CDV 12	BD 2	X 155 CrVMo 12 1 KU	SKD 11		T30402	
			1.2436	X 210 CrW 12				X 215 CrW 12 1 KU	SKD 2	2312	
			1.2601	X 165 CrMoV 12				X 165 CrMoV 12 KU		2310	
			1.2713	55 NiCrMoV 6	55 NCDV 7				SKT 4		T61206
	HS 6-5-2-5	1.3243	1.3243	S 6-5-2-5	Z 85 WDKCV 06-05-05-04-02		HS 6-5-2-5	SKH 55	2723		
	HS 2-10-1-8	1.3247	1.3247	S 2-10-1-8	Z 110 DKCWV 09-08-	BM 42	HS 2-9-1-8	SKH 51		T11342	
	HS 18-0-1	1.3355	1.3355	S 18-0-1	Z 80 WCV 18-04-01	BT 1	HS 18-0-1	SKH 2		T12001	
H11	X 20 Cr 13	1.4021	1.4021	X 20 Cr 13	Z 20 C 13	420 S 37	X 20 Cr 13	SUS 420 J 1	2303	S42000	
	X 70 CrMo 15	1.4109	1.4109	X 65 CrMo 14	Z 70 D 14			SUS 440 A		S44002	
	X 90 CrMoV 18	1.4112	1.4112	X 90 CrMoV 18	Z 2 CND 18 05	409 S 19	X CrTi 12	SUS 440 B	2327	S44003	
	X 105 CrMo 17	1.4125	1.4125	X 105 CrMo 17	Z 100 CD 17		X 105 CrMo 17	SUS 440 C		S44004	
	X 4 CrNiCuNb 16 4	1.4540	1.4540	X 4 CrNiCuNb 16 4						S15500	
	1.4542	1.4542	X 5 CrNiCuNb 16 4					SUS 630		S17400	
	1.4542	1.4542	X 5 CrNiCuNb 16 4					SUS 630		S17400	
	1.4568	1.4568	X 7 CrNiAl 17 7	Z 9 CAN 17.7	301 S 81	X 7 CrNiAl 17 7	SUS 631	2388	S17700		
H12	X 8 CrNiMoAl 15 7 5	1.4574	1.4574	X 8 CrNiMoAl 15 7 5						S15700	
	X 6 NiCrTiMoV 25 15	1.4980	1.4943	X 4 NiCrTi 25 15	Z 6 NCTDV 25.15	HR 51		SUH 660	2570	S66286	
	X 2 NiCoMo 18 8 5	1.6359	1.6359	X 2 NiCoMo 18 8 5		S 162				K92890	
	X 2 NiCoMoTi 18 9 5	1.6358	1.6358	X 2 NiCoMoTi 18 9 5	Z 2 NKD 19-09					K93120	
	X 2 NiCoMoTi 18 9 5	1.6358	1.6358	X 2 NiCoMoTi 18 9 5	Z 2 NKD 19-09					K93120	
	X 2 NiCoMoTi 18 12 4	1.6356	1.6356	X 2 NiCoMoTi 18 12 4						K93160	
H21	X 120 Mn 12	1.3401	1.3401	X 120 Mn 12	Z 120 M 12	BW 10		SC MnH 1	2183		
H31	EN-GJN-HV520	0.9620	0.9620	G-X330 NiCr 4 2	FB Ni4 Cr2 BC	Grade 2 A			05 12-00	F45001	
	EN-GJN-HV550	0.9625	0.9625	G-X260 NiCr 4 2	FB Ni4 Cr2 HC	Grade 2 B			05 13-00	F45000	
	EN-GJN-HV600(XCr11)	0.9630	0.9630	G-X300 CrNiSi 9 5 2	FB Cr9 Ni5	Grade 2 C, D, E			04 57-00	F45003	

Introduzione

Foratura

Alesatura

Barenatura

Allegato

SMG

U.N.E. / I.H.A.	AISI / ASTM	GOST	ČSN	Marchi misti	Condizione	Struttura
				Discolloy	Indurito per precipitazione	
				Haynes 25		
				Stellite 21		
				Hastelloy C		
		KHN65MV		Hastelloy C-276		
				IN 100		
				Inconel 718		
				Inconel X-750	Ricotto solubilizzato	
				Nimonic 80A		
				René 41		
				Udimet 500		
				Waspalloy		
				Ti	Commercialmente puro	Ti (α)
	AMS 4919			Ti 6-2-4-2	Ricotto	Ti (α)
	AMS 4943			Ti 3Al-2.5V (grd 9)	Ricotto	Ti (α+β)
	AMS 4920, Grade 5	VT6		Ti 6Al-4V	Ricotto	Ti (α+β)
	AMS 4986			Ti 10V-2Fe-3Al	Ricotto	Ti (β)
F.1516	5115	12KHN2	14 220		Indurito superficialmente	
F.5103	1070	70			Bonificato	
F.5107	1078, 1080	75			Bonificato	
F.5117	1095				Bonificato	
F.5118	W1	U10A			Bonificato	
	S1	5KHV2SF			Bonificato	
	5155				Bonificato	
F.1252	4142, 4140	38HM	15 142		Bonificato	
F.520L	L2	11KHF			Bonificato	
F.5220	O1	9KHVG			Bonificato	
	O2	9G2F			Bonificato	
F.5230	52100	SHKH15	14 109		Bonificato	
F.5318	H13	4KH5MF1S			Bonificato	
F.5227	A2	9KH5VF			Bonificato	
F.5211	D2	KH12MF			Bonificato	
F.5213		KH12			Bonificato	
		KH12MF			Bonificato	
F.520.S	L6	5KHNM			Bonificato	
F.5613	M35	R6M5K5			Bonificato	
	M42	R2AM9K5			Bonificato	
	T1	R18			Bonificato	
F.5261	420	20KH13	17 022		Bonificato	Martensitico
	440 A				Bonificato	Martensitico
	440 B	95KH18			Bonificato	Martensitico
	440 C	95KH18			Bonificato	Martensitico
	XM-12			15-5 PH	H900	Martensitico
	SAE 630			17-4 PH	H1025	Martensitico
	SAE 630			17-4 PH	H900	Martensitico
	AMS 5528	09KH17N7YU1		17-7 PH	TH1050	Martensitico
	632			PH 15-7 Mo	TH1050	Martensitico
	660			A286	Indurito per precipitazione	Austenitico
	AMS 6512			Marage 250	Indurito per precipitazione	Martensitico
	AMS 6521			Marage 300	Indurito per precipitazione	Martensitico
	AMS 6521			Marage 300	Indurito per precipitazione	Martensitico
	AMS 6515			Marage 350	Indurito per precipitazione	Martensitico
	A128 Grade A			Hadfield		
	A532 IB (NiCr-LC)			Ni-Hard 2		Ghisa bianca
	A532 IA (NiCr-HC)			Ni-Hard 1		Ghisa bianca
	A532 ID (Ni-HiCr)			Ni-Hard 4		Ghisa bianca

Introduzione

Foratura

Alesatura

Barenatura

Allegato

Inserti in metallo duro ed utensili ad inserti

Gli inserti in metallo duro ed i relativi corpi utensile Seco Tools non rientrano nelle categorie prodotto sottocitate. Seco Tools rilascia pertanto la seguente dichiarazione. Questi prodotti soddisfano tutti i requisiti delle normative RoHS (Restriction of the use of certain Hazardous Substances in electrical and electronic equipment), WEEE (Waste Electrical & Electronic Equipment) ed ELV (End of Life Vehicles). All'interno del prodotto non sono presenti mercurio, piombo, cromo esavalente, cadmio, CFC, HCFC, ritardanti di fiamma o solventi in concentrazioni maggiori dei livelli di specifica.

Riaffilatura:

Operazioni di rettifica a secco o ad umido possono generare polveri o vapori potenzialmente tossici che possono irritare pelle, occhi, naso, gola e in caso di esposizione prolungata provocare gravi danni alla salute. Per evitare intossicazioni utilizzare appropriate precauzioni ed avvalersi dei dispositivi di protezione individuale.

Smaltimento:

Seco Tools offre la possibilità di acquistare inserti ed utensili in metallo duro usurati da destinare a riciclo. Gli inserti e gli utensili in metallo duro integrale dovranno essere separati dal comune rifiuto metallico (acciaio, alluminio, rame, ecc.). Il materiale di confezionamento è interamente riciclabile.

Inserti in CBN e PCD

Gli inserti Seco Tools non rientrano nelle categorie prodotto sottocitate. Seco Tools rilascia pertanto la seguente dichiarazione. Questo prodotto soddisfa tutti i requisiti delle normative RoHS (Restriction of the use of certain Hazardous Substances in electrical and electronic equipment), WEEE (Waste Electrical & Electronic Equipment) ed ELV (End of Life Vehicles). All'interno del prodotto non sono presenti mercurio, piombo, cromo esavalente, cadmio, CFC, HCFC, ritardanti di fiamma o solventi in concentrazioni maggiori dei livelli di specifica.

Riaffilatura:

Operazioni di rettifica a secco o ad umido possono generare polveri o vapori potenzialmente tossici che possono irritare pelle, occhi, naso, gola e in caso di esposizione prolungata provocare gravi danni alla salute. Per evitare intossicazioni utilizzare appropriate precauzioni ed avvalersi dei dispositivi di protezione individuale.

Smaltimento:

Seco Tools offre la possibilità di acquistare inserti con riporto in CBN o PCD da destinare a riciclo. Gli inserti dovranno essere separati dal comune rifiuto metallico (acciaio, alluminio, rame, ecc.). Inserti in CBN integrale possono essere smaltiti presso una discarica. Il materiale di confezionamento è interamente riciclabile.

Corpi utensile bruniti

I corpi utensile Seco Tools non rientrano nelle categorie prodotto sottocitate. Seco Tools rilascia pertanto la seguente dichiarazione. Questo prodotto soddisfa tutti i requisiti delle normative RoHS (Restriction of the use of certain Hazardous Substances in electrical and electronic equipment), WEEE (Waste Electrical & Electronic Equipment) ed ELV (End of Life Vehicles). All'interno del prodotto non sono presenti mercurio, piombo, cromo esavalente, cadmio, CFC, HCFC, ritardanti di fiamma o solventi in concentrazioni maggiori dei livelli di specifica.

Disposal:

I corpi utensile possono essere destinati a riciclo come ordinario rifiuto metallico (sfondi e trucioli metallici). Il materiale di confezionamento è interamente riciclabile.

Inseri in cermet

Gli inserti Seco Tools non rientrano nelle categorie prodotto sottocitate. Seco Tools rilascia pertanto la seguente dichiarazione.

Questo prodotto soddisfa tutti i requisiti delle normative RoHS (Restriction of the use of certain Hazardous Substances in electrical and electronic equipment), WEEE (Waste Electrical & Electronic Equipment) ed ELV (End of Life Vehicles).

Gli inserti in cermet qualità C15M contengono nichel e potrebbe verificarsi trasmissione di nichel per contatto con la pelle. La quantità di nichel risulta più elevata rispetto le specifiche del test di riferimento della norma SS-EN 1811, che si riferisce al rilascio di nichel per prodotti che vengono a contatto diretto e prolungato con la pelle. Queste norme sono intese per prodotti che hanno un contatto diretto e prolungato con la pelle, pertanto non sono applicabili in modo diretto ad inserti in cermet. Persone che presentano note reazioni allergiche al nichel sono invitate ad indossare guanti protettivi durante la manipolazione di inserti in cermet.

Riaffilatura:

Operazioni di rettifica a secco o ad umido possono generare polveri o vapori potenzialmente tossici che possono irritare pelle, occhi, naso, gola e in caso di esposizione prolungata provocare gravi danni alla salute. Per evitare intossicazioni utilizzare appropriate precauzioni ed avvalersi dei dispositivi di protezione individuale.

Smaltimento:

Gli inserti usati possono essere riciclati. Gli inserti dovranno essere separati dal comune rifiuto metallico (acciaio, alluminio, rame, ecc.), compresi inserti in metallo duro. Il materiale di confezionamento è interamente riciclabile.

Corpi utensile con rivestimento al nichel

I corpi utensile Seco Tools non rientrano nelle categorie prodotto sottocitate. Seco Tools rilascia pertanto la seguente dichiarazione.

Questo prodotto soddisfa tutti i requisiti delle normative RoHS (Restriction of the use of certain Hazardous Substances in electrical and electronic equipment), WEEE (Waste Electrical & Electronic Equipment) ed ELV (End of Life Vehicles).

All'interno del prodotto non sono presenti mercurio, piombo, cromo esavalente, cadmio, CFC, HCFC, ritardanti di fiamma o solventi in concentrazioni maggiori dei livelli di specifica.

I corpi utensile contengono nichel e ci potrebbe essere trasmissione di nichel per contatto con la pelle. La quantità di nichel non è più elevata rispetto alle specifiche del test di riferimento della norma SS-EN 1811 che si riferisce al rilascio di nichel per prodotti che vengono a contatto diretto e prolungato con la pelle.

Queste norme sono intese per prodotti che hanno un contatto diretto e prolungato con la pelle e pertanto non sono applicabili in modo diretto ai corpi utensile. Persone che presentano note reazioni allergiche al nichel sono invitate ad indossare guanti protettivi durante la manipolazione dei corpi utensile.

Smaltimento

I corpi utensile possono essere destinati a riciclo come ordinario rifiuto metallico (sfridi e trucioli metallici).

Il materiale di confezionamento è interamente riciclabile.

Elementi leganti aggiunti intenzionalmente

Qualità	Metallo duro											Rivestimento						
	W	Ti	Ta	Nb	Co	Cr	Ni	Mo	C	N	Ru	Ti	Al	C	N	O	Si	Nb
CP20	■				■				■			■			■			
CP200	■				■	■			■			■	■		■			
CP300	■	■	■	■	■				■			■	■		■			
CP500	■				■	■			■			■	■		■			
CP600	■				■	■			■			■	■		■			
C15M	■	■	■	■	■		■	■	■			■						
CF	■				■				■			■						
CM	■				■		■	■	■			■						
DP2000	■				■				■			■	■	■	■	■		
DP3000	■	■	■	■	■				■			■	■	■	■	■		
DS2050	■				■	■			■			■	■		■			■
DS4050	■				■	■			■			■	■		■			■
F15M	■				■	■			■			■	■		■			
F25M	■	■	■	■	■	■			■			■	■		■			
F30M	■				■	■			■			■	■		■			
F40M	■				■	■			■			■	■		■			
HX	■		■		■	■			■			■	■		■			
H02	■		■		■	■			■			■	■		■			
H15	■				■	■			■			■	■		■			
H25	■				■	■			■			■	■		■			
KX	■				■	■			■			■	■		■			
MH1000	■				■	■			■			■	■		■			
MK1500	■		■		■	■			■			■	■	■	■	■		
MK2050	■		■		■	■			■			■	■		■		■	
MM4500	■				■	■			■			■	■	■	■	■	■	
MP1501	■		■	■	■	■			■			■	■	■	■	■	■	
MP2050	■				■	■			■		■	■	■		■		■	
MP2501	■		■	■	■	■			■			■	■	■	■	■	■	
MP3000	■				■	■			■			■	■		■		■	
MP3501	■		■	■	■	■			■			■	■	■	■	■	■	
MS2500	■		■	■	■	■			■			■	■	■	■	■	■	
MS2050	■				■	■			■			■	■		■		■	■
RX1500	■		■		■	■	■	■	■			■	■		■		■	
RX2000	■		■		■	■			■			■	■		■		■	
RM2020	■				■	■			■			■	■		■		■	
RM2090	■				■	■			■			■	■		■		■	
RN2010	■				■	■			■			■	■		■		■	
RS2090	■				■	■			■			■	■		■		■	
T350M	■		■	■	■	■			■			■	■	■	■	■	■	
T25M	■		■	■	■	■			■			■	■	■	■	■	■	
TGH1050	■				■	■			■			■	■		■		■	
TGK1500	■		■		■	■			■			■	■	■	■	■	■	
TGP25	■	■	■	■	■	■			■			■	■	■	■	■	■	
TGP35	■		■	■	■	■			■			■	■	■	■	■	■	
TGP45	■		■	■	■	■			■			■	■	■	■	■	■	
TGS2050	■				■	■			■			■	■		■		■	
TH1000	■				■	■			■			■	■		■		■	
TH1500	■				■	■			■			■	■		■		■	
TK0501	■				■	■			■			■	■		■		■	
TK1501	■		■		■	■			■			■	■		■		■	
TM1501	■	■	■	■	■	■			■		■	■	■		■		■	
TM2000	■	■	■	■	■	■			■		■	■	■		■		■	
TM2501	■	■	■	■	■	■			■		■	■	■		■		■	
TM3501	■				■	■			■			■	■		■		■	
TM4000	■	■	■	■	■	■			■		■	■	■		■		■	
TP0501	■				■	■			■			■	■		■		■	
TP1020	■				■	■			■			■	■		■		■	
TP1030	■				■	■			■			■	■		■		■	
TP1501	■	■	■	■	■	■			■		■	■	■		■		■	
TP25	■	■	■	■	■	■			■		■	■	■		■		■	
TP200	■	■	■	■	■	■			■		■	■	■		■		■	
TP2501	■	■	■	■	■	■			■		■	■	■		■		■	
TP3501	■	■	■	■	■	■			■		■	■	■		■		■	
TP40	■		■	■	■	■			■			■	■	■	■	■	■	
TS2000	■				■	■			■			■	■		■		■	
TS2050	■				■	■			■			■	■		■		■	
TS2500	■		■		■	■			■			■	■		■		■	
TTP2050	■				■	■			■			■	■		■		■	
T250D	■				■	■			■			■	■		■		■	
T400D	■				■	■			■			■	■		■		■	
T100R	■		■		■	■			■			■	■		■		■	
T60M	■	■	■	■	■	■			■			■	■		■		■	
883	■		■		■	■			■			■	■		■		■	
890	■				■	■			■			■	■		■		■	

Questo lavoro viene pubblicato con la consapevolezza che Seco Tools e i suoi redattori stanno fornendo informazioni destinate a offrire un orientamento generale relativo all'asportazione di truciolo e relative teorie. Nel caso vengano richiesti servizi professionali per applicazioni specifiche, si consiglia di rivolgersi a un professionista qualificato. Seco Tools e i suoi redattori declinano ogni responsabilità per le dichiarazioni e le garanzie, esplicite o implicite, di qualsiasi tipo, inclusa, ma non limitata a qualsiasi garanzia di commerciabilità, idoneità per un particolare utilizzo, titolo, o di non violazione di alcuna proprietà intellettuale. In nessun caso Seco Tools o i suoi redattori saranno responsabili, nei confronti di nessuno, per eventuali danni diretti, indiretti, specifici o in altro modo conseguenti derivanti dall'uso delle informazioni. Le informazioni fornite nella presente pubblicazione sono solamente a scopo di riferimento. I prezzi effettivi, le specifiche e le descrizioni dei prodotti vengono finalizzati al momento della vendita e possono variare in base alla località. Le informazioni fornite nella presente pubblicazione possono essere soggette a modifiche senza preavviso.



Seco Tools Italia S.p.A. ha adottato un Modello Organizzativo in linea con le prescrizioni del D. Lgs. 231/01. I dettagli relativi al Modello Organizzativo e la copia integrale dell'informativa sulla privacy - ai sensi del D. Lgs. 196/03 - sono disponibili sul sito www.secotools.it.

secotools.com
ST20246789 IT,
© Seco Tools AB, 2024.
Tutti i diritti riservati.

Le specifiche tecniche possono essere soggette a modifiche senza preavviso.